

HANDBOOK

OF AMATEUR TUBE USES



*Edited by
Engineering staff*

50^c

RAYTHEON PRODUCTION CORPORATION

HANDBOOK
FOR
AMATEUR TUBE USES

RAYTHEON

Edited by
Engineering staff

RAYTHEON PRODUCTION CORPORATION

55 CHAPEL STREET NEWTON, MASS.
420 LEXINGTON AVENUE NEW YORK, N. Y.
445 LAKE SHORE DRIVE CHICAGO, ILL.
555 HOWARD STREET SAN FRANCISCO, CAL.
415 PEACHTREE STREET, N.E. ATLANTA, GA.

Copyright 1938
by
RAYTHEON PRODUCTION CORPORATION
Newton, Mass.

It is the responsibility of the user to determine whether any use of the data or circuits presented in this booklet constitutes infringement of any patent, and no liability or obligation of any kind is assumed by Raytheon with respect to such use.

FIRST EDITION
First Printing
June 1938
Form R-633

FOREWORD

This Raytheon "HANDBOOK FOR AMATEUR TUBE USES" is the First Edition of a new booklet which we believe will help the amateur to obtain the finest results from his vacuum tube equipment. It is not the purpose of this manual to duplicate the tables and information which fill the pages of such handbooks as the A.R.R.L.'s "The Radio Amateur's Handbook" and the "Frank C. Jones Radio Handbook". Such books should be near the operating table of every amateur. In the Raytheon Handbook we have endeavored to cover the fundamentals of practical tube operation in a simple and yet complete manner so that the amateur can use it as a guide in the design of his own transmitter and as an aid in understanding the functions of each section of the transmitter. Since the tubes are the heart of any transmitter, one of the first steps in design should be the choice of tubes of proper characteristics and ratings for each stage. This Handbook which lists a complete line of tubes for every amateur requirement should prove particularly useful in making this selection. The amateur usually derives the greatest enjoyment if his outfit is entirely or largely of his own design and it is our hope that this Handbook will contribute to the success and reliability of such outfits.

History records that the first use for a vacuum tube was in a receiver circuit and that the application of the tube for transmission came only after a long period of debate over the possible merit of the vacuum tube as compared with other methods of generating radio signals. For many years, the same tubes were used for transmitting that were employed in receivers. In fact, this practice has been continued by the amateur of today with good, though limited results.

Until a few years ago, the transmitting tubes available to the amateur were designed primarily for the commercial field and for operation at long wave lengths. Except for a few expensive European tubes the amateur could use the 10, 203A, or 204A, if we leave out the less efficient predecessors of these tubes, or he could use a few receiving tubes of the output variety. Fortunately, the 46 and 47 type tubes fitted amateur requirements nicely and were given immediate application when introduced for receiver use.

During the winter of 1932-33, several engineer-amateurs of the Raytheon organization decided that the amateur requirements had been neglected far too long and that a program of development could be carried out which would provide the amateur with tubes really fitted to his requirements and at the same time make new friends for Raytheon. Amateurs all over the world already were familiar with Raytheon gas rectifiers including the type B and BH tubes and the related famous "S" tube. Thus, early in 1933 with a background of more than ten years of experience, Raytheon started the movement to give the amateur the tubes needed for more efficient use of the high and ultra-high frequency spectrum.

Amateurs today may wonder where some of the design ideas originated. Practically all came from amateurs. The first transmitter type of R-F pentode capable of being modulated by the suppressor grid was suggested by the technical staff of the American Radio Relay League. High efficiency triodes, zero bias Class B modulators, "beam" power tubes, etc., are all developments growing out of the suggestions of the technical staff of the A.R.R.L., and other organizations and individuals closely connected with amateur radio. Other developments to come will be developments growing out of the practical application of new types of electronic devices to amateur communication needs. As in the past, amateurs may look to Raytheon for leadership in these developments.

TABLE OF CONTENTS

| | PAGE |
|--|------|
| Choosing a Tube | 5 |
| R-F Power Amplifiers | 5 |
| Triodes | 5 |
| Pentodes | 7 |
| Aligned Grid Tetrodes—Beam Tubes..... | 8 |
| Ultra High Frequency Tubes..... | 10 |
| High Frequency Tubes for Portable Equipment..... | 11 |
| Class B Audio Tubes | 11 |
| Mercury Vapor Rectifiers..... | 12 |
| High Vacuum Rectifiers | 13 |
| Tube Manufacture | 14 |
| Tube Elements | 14 |
| Tube Classification by Structure..... | 15 |
| Tube Classification by Function..... | 15 |
| Fundamental Characteristics of Radio Tubes..... | 15 |
| Tube Application and Circuits..... | 16 |
| Typical Speech Amplifier and Class B Modulators..... | 18 |
| Grid Driving Power and the Exciter..... | 18 |
| Output Impedance and L/C Ratio..... | 20 |
| Modulation | 23 |
| Detector Performance | 29 |
| Ultra High Frequency Operation..... | 29 |
| Tube Materials | 31 |
| Plate Colors of Raytheon Amateur Tubes at Rated Dissipations.. | 32 |
| Ratings of Amateur Tubes..... | 32 |
| Ratings and Characteristics of Raytheon Amateur Tubes | |
| RK-10 | 34 |
| RK-11 | 35 |
| RK-12 | 36 |
| RK-18 | 37 |
| RK-19 : RK-21 : RK-22..... | 38 |
| RK-20A | 39 |
| RK-23 : RK-25 : RK-25B..... | 40 |
| RK-24 | 41 |
| RK-28 | 42 |
| RK-30 | 43 |
| RK-31 | 44 |
| RK-32 | 45 |
| RK-33 | 46 |
| RK-34 | 47 |
| RK-35 | 48 |
| RK-36 | 49 |
| RK-37 | 50 |
| RK-38 | 51 |
| RK-39 : RK-41..... | 52 |
| RK-42 : RK-43..... | 53 |
| RK-44 | 54 |
| RK-45 : RK-46..... | 55 |
| RK-47 | 56 |
| RK-48 | 57 |
| RK-49 | 58 |
| RK-51 | 59 |
| RK-52 | 60 |
| RK-100 | 61 |
| 841 : 842 : 864..... | 62 |
| 866A : 866 : 872A..... | 63 |
| Conversion Curves | 64 |
| Resistance-Coupled Amplifier Design Curves..... | 64 |
| Raytheon Receiving Tubes | 65 |
| Raytheon Miniature Lamps | 66 |
| Raytheon Tubes for Special Applications..... | 66 |
| Plate Colors of Raytheon Amateur Tubes at Rated Dissipations.. | 70 |
| Color Scale for Plate Operating Temperatures..... | 71 |

CHOOSING A TUBE

The following classification of Raytheon Amateur Tubes will be found useful in choosing a tube for any amateur requirement. For complete ratings and operating characteristic curves refer to each type in the rating and characteristic data section.

The following symbols are used in this section:

- E_f —Filament or Heater Voltage
- I_f —Filament or Heater Current
- E_p —D-C Plate Voltage
- E_{c1} —D-C Control Grid Voltage
- E_{c2} —D-C Screen Grid Voltage
- E_{c3} —D-C Suppressor Grid Voltage
- I_p —D-C Plate Current
- I_{c1} —D-C Control Grid Current
- I_{c2} —D-C Screen Grid Current
- R_{c1} —Control Grid Resistor (Grid Leak)
- R_{c2} —Screen Grid Resistor
- R_L —Load Resistance
- P_d —Driving Power
- P_o —Power Output
- E_{ac} —A-C Plate Voltage
- E_{dc} —D-C Output Voltage
- I_{dc} —D-C Output Current

R-F POWER AMPLIFIERS

TRIODES Triodes are commonly used as final amplifiers or as high power drivers. They require more driving power than pentodes and must be neutralized in straight amplifier applications. However, the cost of a triode is considerably less than that of a pentode of the same plate dissipation rating and triodes are generally better adapted for plate modulation. The input and output capacitances of triodes are smaller than those of pentodes and as a result triodes are usually more suitable for very high frequency operation (beyond 14 megacycles).

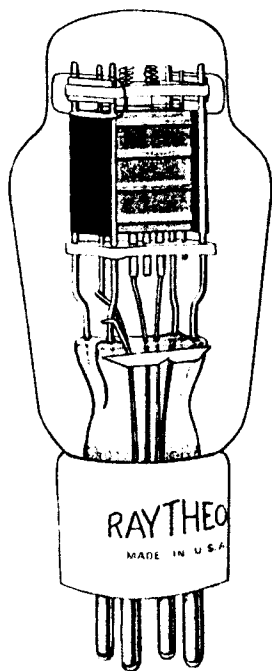

RK-10

The RK-10 is similar to the receiving type 10 which has served the amateur so long and faithfully. This tube, however, is specially designed for transmitting use, has a higher plate dissipation and incorporates an isolantite base for improved high frequency performance.

- FilamentThoriated Tungsten
- Base Isolantite
- PlateCarbonized Nickel
- BulbSoft Glass
- Plate Dissipation15 watts
- Amplification Factor 8

CLASS C—TELEGRAPHY

SINGLE TUBE

| | | |
|--------------------------|------|-------|
| E_f | 7.5 | volts |
| I_f | 1.25 | amp |
| E_p | 450 | volts |
| E_{c1} | -100 | volts |
| I_p | 65 | ma |
| I_{c1} | 15 | ma |
| R_{c1} (approx.) | 7000 | ohms |
| P_o | 19 | watts |

PUSH-PULL—TWO TUBES

| | | |
|--------------------------|------|-------|
| E_p | 450 | volts |
| E_{c1} | -100 | volts |
| I_p | 130 | ma |
| I_{c1} | 30 | ma |
| R_{c1} (approx.) | 3500 | ohms |
| P_o | 38 | watts |

RK-11 RK-12

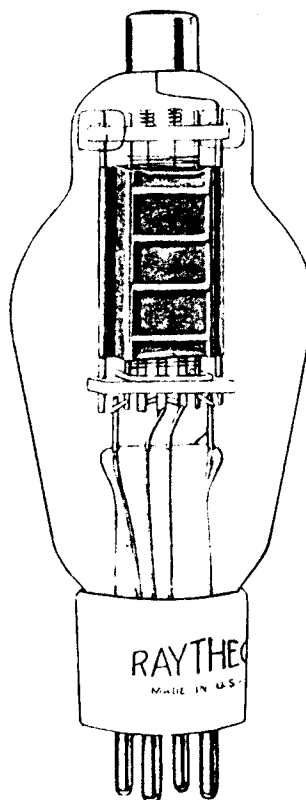

The RK-11 and RK-12 fill the gap between the RK-10 and higher powered tubes like the RK-51 and RK-52. The construction of these tubes is such that they represent the maximum power output per dollar of any tube in the amateur line. The plate lead is brought out the top of the bulb to reduce interelectrode capacitances and to insure against voltage breakdown. The RK-11 has an amplification factor of 20 and is a general all purpose triode that may be used in any application where a tube of its characteristics is desired.

The RK-12, with an amplification factor of approximately 80, is particularly applicable to zero bias operation either as a double or as a final amplifier for telegraphy. When used in this fashion the driving power requirement is extremely small, only two watts for fifty watts output. At rated plate voltage the plate current without excitation of the RK-12 is so low that the tube is protected in case of failure of excitation during the tuning-up process or in subsequent operation.

- FilamentThoriated Tungsten
- PlateCarbonized Nickel
- Base Isolantite
- BulbSoft Glass
- Plate Dissipation25 watts
- RK-11 Amplification Factor20
- RK-12 Amplification Factor (approx.)80

CLASS C—TELEGRAPHY

SINGLE TUBE

| | RK-11 | RK-12 | |
|--------------------------|-------|-------|-------|
| E_f | 6.3 | 6.3 | volts |
| I_f | 3.0 | 3.0 | amp |
| E_p | 750 | 750 | volts |
| E_{c1} | -100 | 0 | volts |
| I_p | 105 | 100 | ma |
| I_{c1} | 21 | 32 | ma |
| R_{c1} (approx.) | 5000 | 0 | ohms |
| P_o | 55 | 50 | watts |

PUSH-PULL—TWO TUBES

| | RK-11 | RK-12 | |
|--------------------------|-------|-------|-------|
| E_p | 750 | 750 | volts |
| E_{c1} | -100 | 0 | volts |
| I_p | 210 | 200 | ma |
| I_{c1} | 42 | 64 | ma |
| R_{c1} (approx.) | 2500 | 0 | ohms |
| P_o | 110 | 100 | watts |

RK-51 RK-52

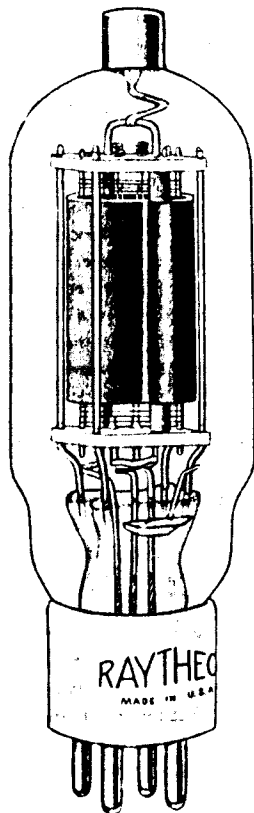

The RK-51 and RK-52 utilize graphite plates for improved heat radiation and freedom from mechanical warping. The RK-51 with an amplification of 20, is a medium μ tube and may be used as a general all purpose triode.

The RK-52 may be operated as a doubler or amplifier at zero bias with low driving power requirements (3.5 watts).

- FilamentThoriated Tungsten
- Plate Graphite
- Base Isolantite
- Bulb Hard Glass
- Plate Dissipation60 watts
- RK-51 Amplification Factor...20
- RK-52 Amplification Factor (approx.)
150

**CLASS C—TELEGRAPHY
SINGLE TUBE**

| | RK-51 | RK-52 | |
|--------------------------|-------|-------|-------|
| E_f | 7.5 | 7.5 | volts |
| I_f | 3.75 | 3.75 | amp |
| E_p | 1500 | 1500 | volts |
| E_{c1} | -250 | 0 | volts |
| I_p | 150 | 150 | ma |
| I_{c1} | 31 | 50 | ma |
| R_{c1} (approx.) | 8000 | 0 | ohms |
| P_o | 170 | 150 | watts |

PUSH-PULL—TWO TUBES

| | RK-51 | RK-52 | |
|--------------------------|-------|-------|-------|
| E_p | 1500 | 1500 | volts |
| E_{c1} | -250 | 0 | volts |
| I_p | 300 | 300 | ma |
| I_{c1} | 62 | 100 | ma |
| R_{c1} (approx.) | 4000 | 0 | ohms |
| P_o | 340 | 300 | watts |

RK-18 RK-31

The RK-18 and RK-31 use molybdenum plates and since it is permissible to operate molybdenum plates at higher temperatures than graphite or carbonized nickel, the area of these plates is less per watt of plate dissipation. In the case of the RK-18 this results in materially reduced interelectrode capacitances. The RK-18 is an excellent high frequency tube and can be used as

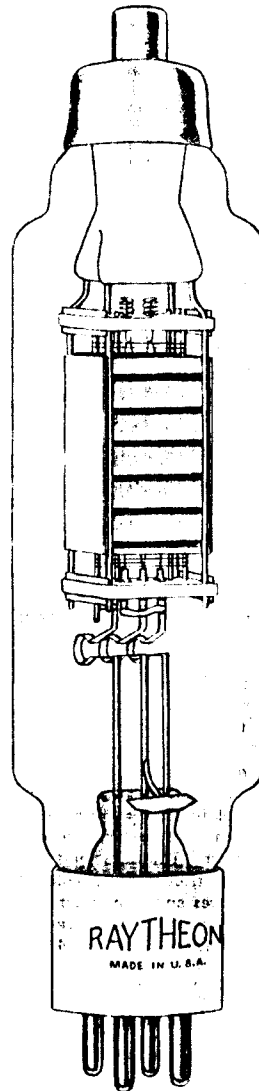

an amplifier at full ratings up to 30 megacycles. Although the RK-18 is somewhat more expensive than some of the newer type tubes because of its constructional features, its good operating characteristics still make it an excellent all purpose triode.

The RK-31 is a double grid tube and is primarily designed for audio work. Although the use of the double grid produces a relatively high value of grid to plate capacitance, the RK-31 can be successfully used for high frequency operation, particularly in zero bias applications. The double grid feature greatly reduces the required driving power so that for an output of 95 watts only 2.2 watts of driving power is required. The power gain of 43 compares favorably with the power gain possible with a pentode.

- FilamentThoriated Tungsten
- Plate Molybdenum
- Base Isolantite
- BulbSoft Glass
- Plate Dissipation40 watts
- RK-18 Amplification Factor...18
- RK-31 Amplification Factor (approx.)
75

**CLASS C—TELEGRAPHY
SINGLE TUBE**

| | RK-18 | RK-31 | |
|--------------------------|-------|-------|-------|
| E_f | 7.5 | 7.5 | volts |
| I_f | 3.0 | 3.0 | amp |
| E_p | 1250 | 1250 | volts |
| E_{c1} | -160 | 0 | volts |
| I_p | 100 | 110 | ma |
| I_{c1} | 12 | 38 | ma |
| R_{c1} (approx.) | 13000 | 0 | ohms |
| P_o | 95 | 95 | watts |

PUSH-PULL—TWO TUBES

| | RK-18 | RK-31 | |
|--------------------------|-------|-------|-------|
| E_p | 1250 | 1250 | volts |
| E_{c1} | -160 | 0 | volts |
| I_p | 200 | 220 | ma |
| I_{c1} | 24 | 76 | ma |
| R_{c1} (approx.) | 6500 | 0 | ohms |
| P_o | 190 | 100 | watts |

RK-35 RK-37

The RK-35 and RK-37 are tantalum plate tubes with the grid brought out the side and the plate out the top of the bulb. The use of tantalum plates results in a large factor of safety under temporary overloads and makes possible low interelectrode capacitances. These and other design features make these tubes suitable for operation at the ultra high frequencies.

The filaments of the RK-35 and the RK-37 are adequately large to meet the peak requirements demanded by high efficiency operation.

FilamentThoriated Tungsten
 Plate Tantalum
 Base Isolantite
 BulbHard Glass
 Plate Dissipation 50 watts
 RK-35 Amplification Factor 9

RK-37 Amplification Factor 30

**CLASS C—TELEGRAPHY
 SINGLE TUBE**

| | RK-35 | RK-37 | |
|--------------------|-------|-------|-------|
| E_r | 7.5 | 7.5 | volts |
| I_r | 4.0 | 4.0 | amp |
| E_p | 1500 | 1500 | volts |
| E_{c1} | -250 | -130 | volts |
| I_p | 115 | 115 | ma |
| I_{c1} | 15 | 30 | ma |
| R_{c1} (approx.) | 15000 | 5000 | ohms |
| P_o | 120 | 122 | watts |

PUSH-PULL—TWO TUBES

| | RK-35 | RK-37 | |
|--------------------|-------|-------|-------|
| E_p | 1500 | 1500 | volts |
| E_{c1} | -250 | -130 | volts |
| I_p | 230 | 230 | ma |
| I_{c1} | 30 | 60 | ma |
| R_{c1} (approx.) | 7500 | 2500 | ohms |
| P_o | 240 | 244 | watts |

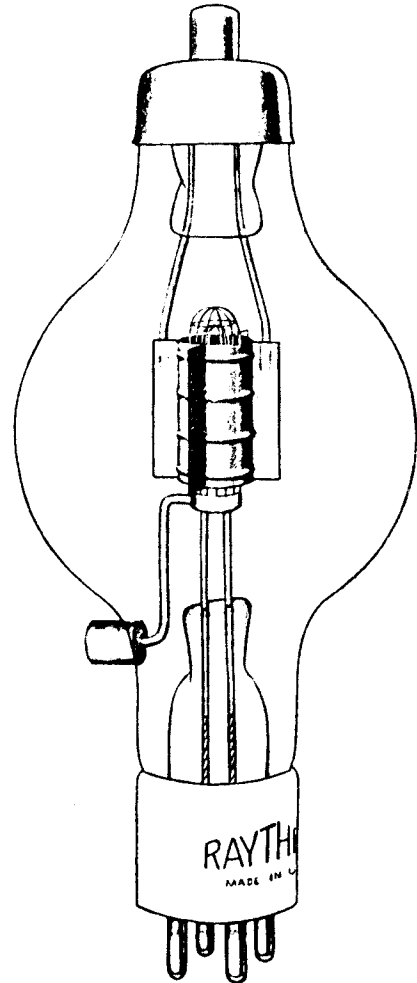
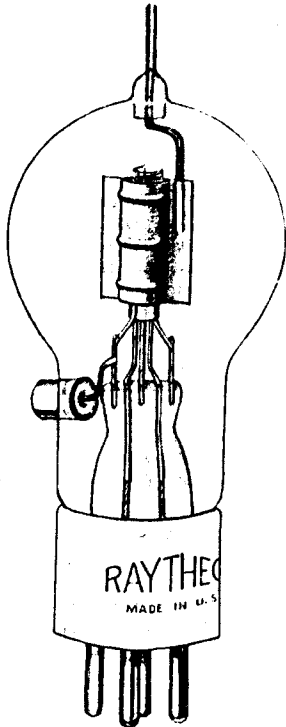

RK-36 RK-38

(See Next Column)

The RK-36 and RK-38 are larger editions of the RK-35 and RK-37 and have the same advantages already described for those tubes. The RK-38 is a higher μ tube than the RK-36 and its driving power requirements are somewhat smaller. Two of these tubes in push-pull, operating at the maximum ratings, offer the possibility of using the maximum lawful input of 1000 watts without recourse to excessively high plate voltages.

FilamentThoriated Tungsten
 Plate Tantalum
 Base Isolantite
 BulbHard Glass
 Plate Dissipation 100 watts
 RK-36 Amplification Factor 14
 RK-37 Amplification Factor 30

**CLASS C—TELEGRAPHY
 SINGLE TUBE**

| | RK-36 | RK-38 | |
|--------------------|-------|-------|-------|
| E_r | 5 | 5 | volts |
| I_r | 8 | 8 | amp |
| E_p | 2000 | 2000 | volts |
| E_{c1} | -360 | -200 | volts |
| I_p | 150 | 160 | ma |
| I_{c1} | 30 | 30 | ma |
| R_{c1} (approx.) | 12000 | 6650 | ohms |
| P_o | 200 | 225 | watts |

PUSH-PULL—TWO TUBES

| | RK-36 | RK-38 | |
|--------------------|-------|-------|-------|
| E_p | 2000 | 2000 | volts |
| E_{c1} | -360 | -200 | volts |
| I_p | 300 | 320 | ma |
| I_{c1} | 60 | 60 | ma |
| R_{c1} (approx.) | 6000 | 3325 | ohms |
| P_o | 400 | 450 | watts |
| E_p | 3000 | 3000 | volts |
| E_{c1} | -540 | -300 | volts |
| I_p | 330 | 330 | ma |
| I_{c1} | 60 | 75 | ma |
| R_{c1} | * | * | |
| P_o | 800 | 800 | watts |

*Full battery bias or battery bias to cutoff and remainder resistor bias.

R-F POWER AMPLIFIERS—CONTINUED

PENTODES Pentodes are used as crystal oscillators, buffer amplifiers, and in final amplifier stages. They are characterized by very high power gain and by low values of control grid to plate capacitance. The power gain of a pentode, when used as a Class C amplifier, for instance, is about 100 as compared to between 10 and 20 for a triode. These features make them particularly suitable for use in multiband transmitters where it is desired to use a small number of stages, a minimum of coil switching in the exciter and no neutralization.

Modulation of pentodes can take place by simultaneous modulation of the plate and screen or by modulation of the suppressor grid. Suppressor grid modulation is one of the simplest and most fool proof modulation methods that has been devised. The audio power required for suppressor modulation is very small and can be supplied from a very low power modulator. The RK-28, for example, which is the highest power pentode in the Raytheon Amateur line, requires less than 2 watts of modulating power for a carrier output of 60 watts.

Because of the very low driving power requirements, even high power pentodes can be successfully operated as crystal oscillators, either as straight oscillators or in circuits such as the Tri-tet.

Pentodes have a disadvantage in that considerable power is wasted in the screen and usually a separate power supply is required. However, in most instances this power supply can also be used to supply the exciter stages and, hence, does not particularly add to the original cost of a transmitter.

RK-23 RK-25 RK-25B

(See Next Column)

The RK-23, RK-25, and RK-25B are low power pentodes. The RK-23 has a 2.5 volt heater; the RK-25 and the RK-25B have 6.3 volt heaters. The RK-25B is identical with the RK-25 except for the base which is of bakelite and may be used in applications where an isolantite base is not considered necessary.

These tubes are particularly suitable for use as crystal oscillators, frequency doublers, or buffer amplifiers. The control grid to plate capacitance is so low that neutralization is unnecessary in any amplifier application. These tubes also offer the possibility of suppressor grid modulation either as final amplifiers or as drivers for Class B linear stages. The output of a single tube, suppressor grid modulated, is more than adequate to drive an RK-37 as a Class B linear amplifier with a carrier output of 50 watts. At the low frequencies (1.7 to 3.5 megacycles) one tube, suppressor modulated, can drive two RK-37's as Class B linear amplifiers with a carrier output of 100 watts.

RK-23 RK-25 RK-25B (Cont.)

Filament Heater Cathode
 Plate Carbonized Nickel
 Base—RK-23 and RK-25..... Isolantite
 Base—RK-25B..... Bakelite
 Bulb Soft Glass
 Plate Dissipation 10 watts

CLASS C—TELEGRAPHY
 SINGLE TUBE

| | RK-23 | RK-25 | RK-25B | |
|--------------------|-------|-------|--------|-------|
| E_r | 2.5 | 6.3 | | volts |
| I_r | 2.0 | 0.9 | | amp |
| E_p | 500 | | | volts |
| E_{c1} | -90 | | | volts |
| E_{c2} | 200 | | | volts |
| E_{c3} | 0 | | | volts |
| I_p | 50 | | | ma |
| I_{c2} | 40 | | | ma |
| I_{c1} | 4 | | | ma |
| R_{c1} (approx.) | 22000 | | | ohms |
| R_{c2} | 7500 | | | ohms |
| P_o | 18 | | | watts |

PUSH-PULL—TWO TUBES

| | | |
|--------------------|-------|-------|
| E_p | 500 | volts |
| E_{c1} | -90 | volts |
| E_{c2} | 200 | volts |
| E_{c3} | 0 | volts |
| I_p | 100 | ma |
| I_{c2} | 80 | ma |
| I_{c1} | 8 | ma |
| R_{c1} (approx.) | 11000 | ohms |
| R_{c2} | 3750 | ohms |
| P_o | 36 | watts |

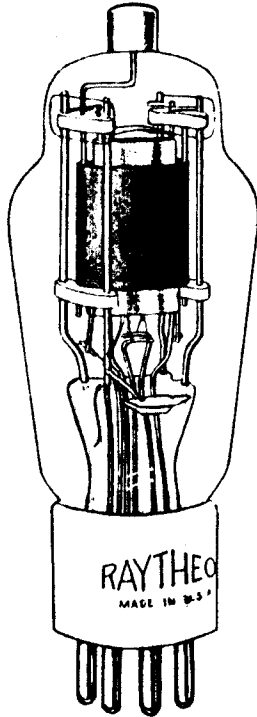

RK-20A

The RK-20A is a medium power pentode adaptable to many classes of service and is an improved form of the RK-20, the original amateur r-f power pentode. Its pentode features make it particularly applicable to multiband transmitters where the number of tubes and circuits must be kept to a minimum.

Suppressor grid modulation may be used and will give a carrier output of 21 watts with only 1 watt of audio input. The small amount of audio equipment required and the ease of adjustment make modulation in this manner particularly attractive.

The RK-20A may also be operated as a high-power crystal oscillator without overloading the crystal.

Filament Thoriated Tungsten
 Plate Molybdenum
 Base Isolantite
 Bulb Hard Glass
 Plate Dissipation 40 watts

CLASS C—TELEGRAPHY
 SINGLE TUBE

| | | |
|--------------------|-------|-------|
| E_r | 7.5 | volts |
| I_r | 3.25 | amp |
| E_p | 1250 | volts |
| E_{c1} | -100 | volts |
| E_{c2} | 300 | volts |
| E_{c3} | +45 | volts |
| I_p | 92 | ma |
| I_{c1} | 11.5 | ma |
| I_{c2} | 36 | ma |
| R_{c1} (approx.) | 10000 | ohms |
| P_o | 84 | watts |

PUSH-PULL—TWO TUBES

| | | |
|--------------------|------|-------|
| E_p | 1250 | volts |
| E_{c1} | -100 | volts |
| E_{c2} | 300 | volts |
| E_{c3} | +45 | volts |
| I_p | 184 | ma |
| I_{c1} | 23 | ma |
| I_{c2} | 72 | ma |
| R_{c1} (approx.) | 5000 | ohms |
| P_o | 168 | watts |

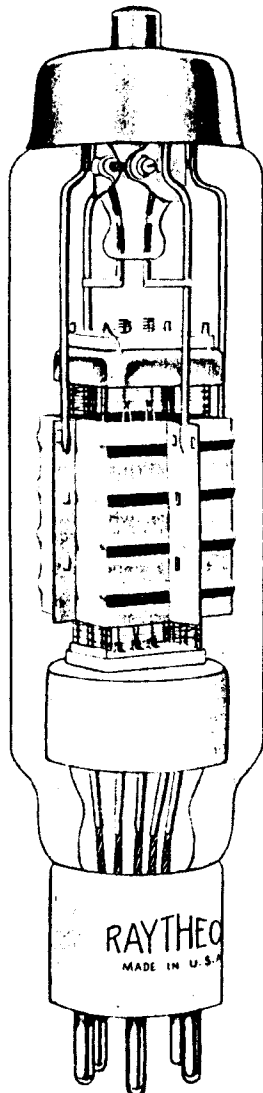

RK-28

The RK-28 is one of the largest pentodes available to the amateur and has all the advantages described for the RK-20A. The tube may be operated satisfactorily as a crystal oscillator although great care must be exercised to keep the input and output circuits well shielded from each other.

With suppressor grid modulation the carrier power output is 60 watts with 1.2 watts audio input. The power gain of this tube is higher than that of the RK-20A. This, of course, suggests operation in multiband transmitters. Neutralization is not required in any application.

Filament ... Thoriated Tungsten
 Plate Molybdenum
 Base Isolantite
 Bulb Hard Glass
 Plate Dissipation 100 watts

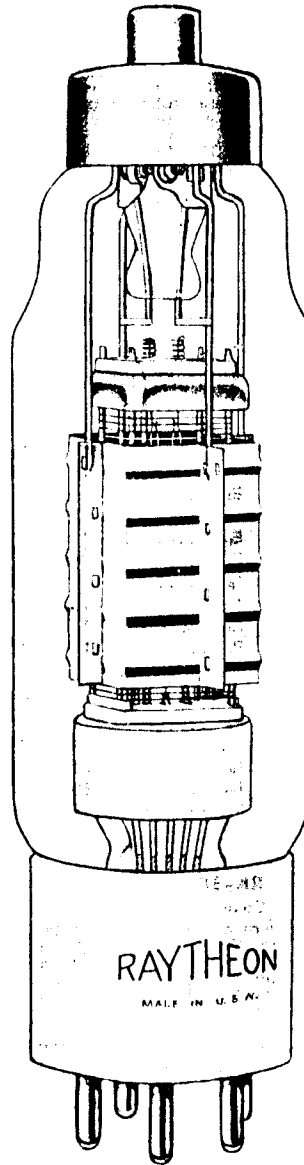

CLASS C—TELEGRAPHY
 SINGLE TUBE

| | | |
|--------------------|------|-------|
| E_r | 10 | volts |
| I_r | 5 | amp |
| E_p | 2000 | volts |
| E_{c1} | -100 | volts |
| E_{c2} | 400 | volts |
| E_{c3} | +45 | volts |
| I_p | 150 | ma |
| I_{c1} | 13 | ma |
| I_{c2} | 55 | ma |
| R_{c1} (approx.) | 8000 | ohms |
| P_o | 210 | watts |

PUSH-PULL—TWO TUBES

| | | |
|--------------------|------|-------|
| E_p | 2000 | volts |
| E_{c1} | -100 | volts |
| E_{c2} | 400 | volts |
| E_{c3} | +45 | volts |
| I_p | 300 | ma |
| I_{c1} | 26 | ma |
| I_{c2} | 110 | ma |
| R_{c1} (approx.) | 4000 | ohms |
| P_o | 420 | watts |

R-F POWER AMPLIFIERS—CONTINUED

ALIGNED GRID TETRODES—BEAM TUBES The aligned grid tetrodes make use of electron concentration to obtain effects similar to those produced by the suppressor grid in a pentode. The aligned grid feature results in a very high ratio of plate current to screen current permitting a larger portion of the space current to be available for the plate. In addition, reduced screen dissipation permits a slightly higher maximum plate dissipation than in an equivalent pentode type. As a result more power output and greater power gain are possible. Modulation by means of the plate alone is practical at plate voltages approaching the maximum rated value.

RK-49

(See Next Column)

The RK-49 is an aligned grid tetrode similar in characteristics to the 6L6G but with a six pin isolantite base. The grid to plate capacitance of the RK-49 is 1.4 micromicrofarads, which in most amplifier applications makes neutralization necessary. As a crystal oscillator, however, the grid to plate capacitance contributes to the proper performance of the circuit and makes it unnecessary to add external capacitance as often must be done with tubes having lower interelectrode capacitances. The tube, therefore, is particularly adaptable to crystal oscillator service, and to doubler circuits where neutralization is not required. It may be used as an amplifier where the neutralization requirement is not considered objectionable.

The tube may be modulated by means of the plate alone or by means of the screen grid.

RK-49 (Cont.)

| | | |
|-------------------|-------|-------------------|
| Filament | | Heater Cathode |
| Plate | | Carbonized Nickel |
| Base | | Isolantite |
| Bulb | | Soft Glass |
| Plate Dissipation | | 21 watts |

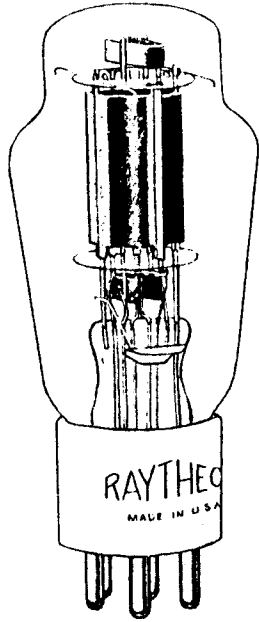

CLASS C—TELEGRAPHY
SINGLE TUBE

| | | | |
|--------------------|-------|-------|-------|
| E_f | | 6.3 | volts |
| I_f | | 0.9 | amp |
| E_p | | 400 | volts |
| E_{c1} | | -50 | volts |
| E_{c2} | | 250 | volts |
| I_p | | 95 | ma |
| I_{c1} | | 3 | ma |
| I_{c2} | | 8 | ma |
| R_{c1} (approx.) | ... | 15000 | ohms |
| R_{c2} (approx.) | ... | 20000 | ohms |
| P_o | | 25 | watts |

PUSH-PULL—TWO TUBES

| | | | |
|--------------------|-------|-------|-------|
| E_p | | 400 | volts |
| E_{c1} | | -50 | volts |
| E_{c2} | | 250 | volts |
| I_p | | 190 | ma |
| I_{c1} | | 6 | ma |
| I_{c2} | | 16 | ma |
| R_{c1} (approx.) | ... | 7500 | ohms |
| R_{c2} (approx.) | ... | 10000 | ohms |
| P_o | | 50 | watts |

RK-39 RK-41

The RK-39 and RK-41 are aligned grid tetrodes more suitable than the RK-49 for use as straight amplifiers. The plate lead is brought out the top of the bulb and certain refinements added to reduce the interelectrode capacitances to a minimum. A higher plate voltage is permissible because of improved plate insulation. Neutralization is unnecessary and the tube may be used as a straight amplifier without this complication.

For straight crystal oscillator service, it is usually necessary to add 1 or 2 micromicrofarads of external grid to plate capacitance. This may take the form of two pieces of insulated wire twisted together with about 2 twists, one piece connected to the plate and the other to the grid.

| | | |
|-------------------|-------|-------------------|
| Filament | | Heater Cathode |
| Plate | | Carbonized Nickel |
| Base | | Isolantite |
| Bulb | | Soft Glass |
| Plate Dissipation | | 25 watts |

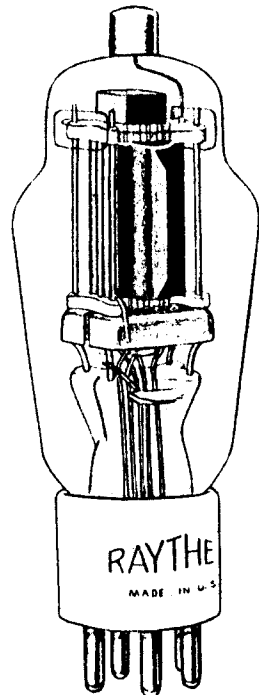

CLASS C—TELEGRAPHY
SINGLE TUBE

| | | | | |
|--------------------|-------|-------|-----|-------|
| RK-39 RK-41 | | | | |
| E_f | | 6.3 | 2.5 | volts |
| I_f | | 0.9 | 2.4 | amp |
| E_p | | 600 | | volts |
| E_{c1} | | -90 | | volts |
| E_{c2} | | 300 | | volts |
| I_p | | 93 | | ma |
| I_{c1} | | 3.0 | | ma |
| I_{c2} | | 10 | | ma |
| R_{c1} (approx.) | ... | 30000 | | ohms |
| R_{c2} (approx.) | ... | 30000 | | ohms |
| P_o | | 36 | | watts |

PUSH-PULL—TWO TUBES

| | | | |
|--------------------|-------|-------|-------|
| E_p | | 600 | volts |
| E_{c1} | | -90 | volts |
| E_{c2} | | 300 | volts |
| I_p | | 186 | ma |
| I_{c1} | | 6 | ma |
| I_{c2} | | 20 | ma |
| R_{c1} (approx.) | ... | 15000 | ohms |
| R_{c2} (approx.) | ... | 15000 | ohms |
| P_o | | 72 | watts |

RK-47

The RK-47 is an aligned grid or beam type edition of the RK-20A and will give more power output and has a better power gain. The tube cannot, of course, be suppressor grid modulated but on the other hand, modulation by means of the plate alone is permissible provided the excitation is adequate.

Because of the relatively high grid to plate capacitance of the RK-47 the operation of this tube as a crystal oscillator is not recommended.

| | | |
|-------------------|-------|--------------------|
| Filament | | Thoriated Tungsten |
| Plate | | Molybdenum |
| Base | | Isolantite |
| Bulb | | Hard Glass |
| Plate Dissipation | | 50 watts |

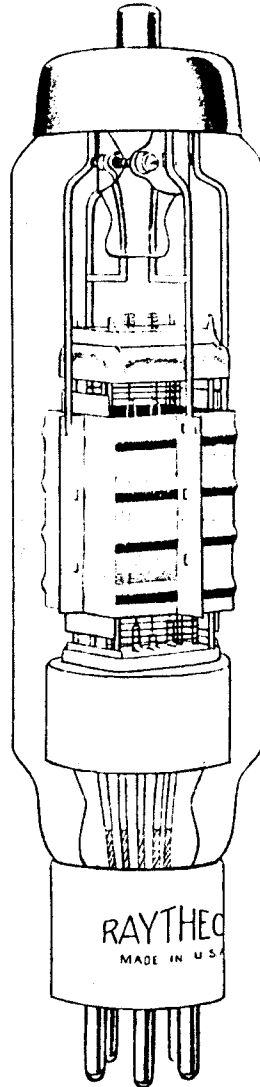

CLASS C—TELEGRAPHY
SINGLE TUBE

| | | | |
|--------------------|-------|-------|-------|
| E_f | | 10 | volts |
| I_f | | 3.25 | amp |
| E_p | | 1250 | volts |
| E_{c1} | | -70 | volts |
| E_{c2} | | 300 | volts |
| I_p | | 138 | ma |
| I_{c1} | | 7 | ma |
| I_{c2} | | 14 | ma |
| R_{c1} (approx.) | ... | 10000 | ohms |
| P_o | | 120 | watts |

PUSH-PULL—TWO TUBES

| | | | |
|--------------------|-------|------|-------|
| E_p | | 1250 | volts |
| E_{c1} | | -70 | volts |
| E_{c2} | | 300 | volts |
| I_p | | 276 | ma |
| I_{c1} | | 14 | ma |
| I_{c2} | | 28 | ma |
| R_{c1} (approx.) | ... | 5000 | ohms |
| P_o | | 240 | watts |

RK-48

The RK-48 is an aligned grid edition of the RK-28 and the power output and power gain are somewhat better.

Plate modulation of this tube is permissible under proper conditions. Its use is not recommended as a crystal oscillator. Two RK-48's in push-pull will give 500 watts output and the driving power may be supplied by a crystal oscillator using one RK-49. The plate voltage for the RK-49 may be obtained from the screen voltage supply for the RK-48's.

| | |
|-------------------|-------------------------|
| Filament |Thoriated Tungsten |
| Plate | Molybdenum |
| Base | Isolantite |
| Bulb |Hard Glass |
| Plate Dissipation |100 watts |

CLASS C—TELEGRAPHY

SINGLE TUBE

| | | |
|--------------------|-------------|-------|
| E_r | 10 | volts |
| I_r | 5 | amp |
| E_p | 2000 | volts |
| E_{c1} | -100 | volts |
| E_{c2} | 400 | volts |
| I_p | 180 | ma |
| I_{c1} | 8 | ma |
| I_{c2} | 27 | ma |
| R_{c1} (approx.) | 12500 | ohms |
| P_o | 250 | watts |

PUSH-PULL—TWO TUBES

| | | |
|--------------------|------------|-------|
| E_p | 2000 | volts |
| E_{c1} | -100 | volts |
| E_{c2} | 400 | volts |
| I_p | 360 | ma |
| I_{c1} | 16 | ma |
| I_{c2} | 54 | ma |
| R_{c1} (approx.) | 6250 | ohms |
| P_o | 500 | watts |

ULTRA HIGH FREQUENCY TUBES

Tubes for use at the ultra high frequencies are characterized by low inter-electrode capacitances and relatively short external paths between the grid and the plate connections to permit the shortest possible leads to the external circuit. The grid, plate and filament leads are widely separated to reduce the leakage paths and are designed to avoid excessive seal temperatures due to heavy lead charging currents.

RK-34

(See Next Column)

The RK-34 is a twin triode similar in characteristics to the type 6A6 but is adapted to push-pull ultra high frequency operation as it has an isolantite base and the plate connections are brought out to two separate terminals at the top of the bulb. This makes the tube particularly adaptable for use in tuned-grid, tuned-plate oscillators using long lines in the grid and plate circuits. The optimum load impedance of the RK-34 is low which results in improved tank circuit efficiency. The physical dimensions of the RK-34 are small enough to permit efficient push-pull operation at 240 megacycles. The high frequency limit is practically realized when the grid circuit is directly across the base pins and approaches 300 megacycles depending on the circuit.

RK-34 (Cont.)

| | | |
|--------------------------------|------------------------|---------|
| Filament |Heater | Cathode |
| Plate |Carbonized Nickel | |
| Base | Isolantite | |
| Bulb |Soft Glass | |
| Plate Dissipation (per triode) |5 | watts |
| Amplification Factor |13 | |

PUSH-PULL OSCILLATOR

| | | |
|----------|------------|-------|
| E_r | 6.3 | volts |
| I_r | 0.8 | amp |
| E_p | 300 | volts |
| E_{c1} | -36 | volts |
| I_p | 80 | ma |
| I_{c1} | 18 | ma |
| R_{c1} | 2000 | ohms |
| P_o | 14 | watts |

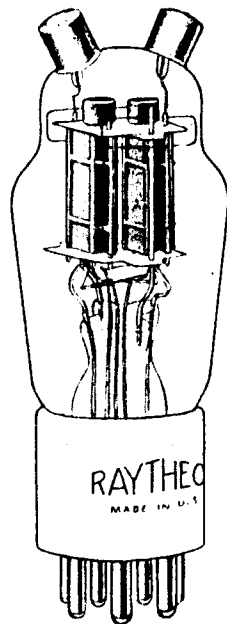
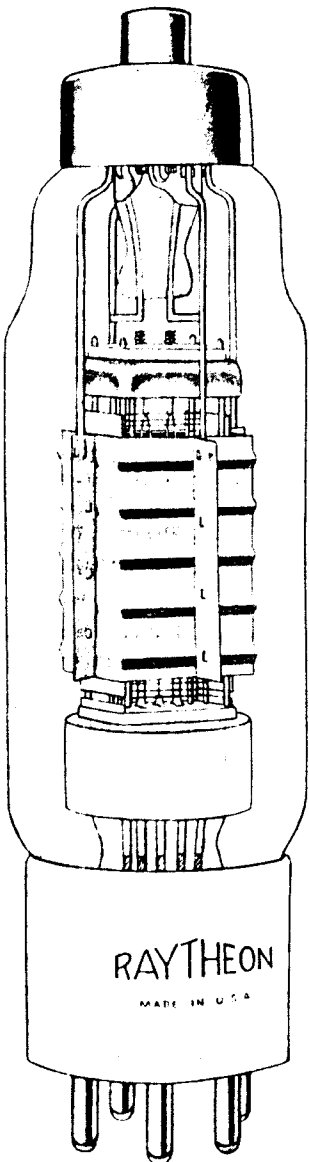

RK-30

The RK-30 is an excellent ultra high frequency triode due to its low interelectrode capacitances and the position of the grid and plate leads which are brought out through the top of the bulb. This feature permits the use of extremely short connecting leads to an external inductance and as a result the ultimate frequency of this tube with the shortest circuit possible between the grid and plate is in the vicinity of 300 megacycles.

The tube may be safely operated at full rating up to 60 megacycles, at 120 megacycles it may be operated at a plate voltage of 1000 volts; beyond 120 megacycles the plate voltage should not exceed 750 volts.

| | |
|----------------------|-----------------------|
| Filament | ...Thoriated Tungsten |
| Plate | Molybdenum |
| Base | Isolantite |
| Bulb |Soft Glass |
| Plate Dissipation |35 watts |
| Amplification Factor | ...15 |

CLASS C—TELEGRAPHY

SINGLE TUBE

| | | |
|--------------------|-------------|-------|
| E_r | 7.5 | volts |
| I_r | 3.25 | amp |
| E_p | 1250 | volts |
| E_{c1} | -180 | volts |
| I_p | 90 | ma |
| I_{c1} | 18 | ma |
| R_{c1} (approx.) | 10000 | ohms |
| P_o | 83 | watts |

PUSH-PULL—TWO TUBES

| | | |
|--------------------|------------|-------|
| E_p | 1250 | volts |
| E_{c1} | -180 | volts |
| I_p | 180 | ma |
| I_{c1} | 36 | ma |
| R_{c1} (approx.) | 5000 | ohms |
| P_o | 166 | watts |

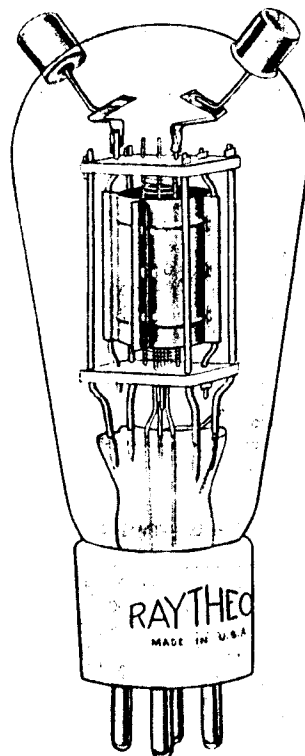

RK-32

The RK-32 is specially designed for ultra high frequency operation. Interelectrode capacitances have been cut to a minimum by use of a tantalum plate. The plate and grid leads are brought out together at the top of the bulb to permit short leads to external circuits. Full ratings may be used up to 100 megacycles. The plate voltage should be reduced proportionately with frequency to a plate voltage of 750 volts at 300 megacycles. The high frequency limit of this tube with the smallest possible external circuit is approximately 400 megacycles.

Filament ... Thoriated Tungsten
 Plate Tantalum
 Base Isolantite
 Bulb Hard Glass
 Plate Dissipation 50 watts
 Amplification Factor ... 11

CLASS C—TELEGRAPHY

SINGLE TUBE

| | | |
|--------------------------|-------|-------|
| E_r | 7.5 | volts |
| I_r | 3.25 | amp |
| E_p | 1250 | volts |
| E_{c1} | -225 | volts |
| I_p | 100 | ma |
| I_{c1} | 14 | ma |
| R_{c1} (approx.) | 16000 | ohms |
| P_u | 90 | watts |

PUSH-PULL—TWO TUBES

| | | |
|--------------------------|------|-------|
| E_p | 1250 | volts |
| E_{c1} | -225 | volts |
| I_p | 200 | ma |
| I_{c1} | 28 | ma |
| R_{c1} (approx.) | 8000 | ohms |
| P_u | 180 | watts |

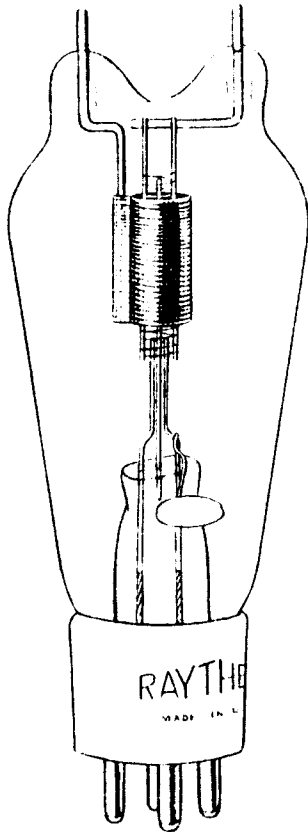

ULTRA HIGH FREQUENCY TUBES FOR PORTABLE EQUIPMENT

Tubes of this type are designed with especially efficient emitters to reduce filament batteries to a minimum. They must also be of rugged construction to withstand the shocks that are sure to be part of such service.

RK-42

The RK-42 is a triode which will find application where small, light-weight equipment is required. Its filament requirement is the lowest of any Raytheon tube and may be operated from a 1.5 volt flashlight cell. Although a bakelite base is used, the operating temperature of the base is so low that little loss from this source is encountered.

The tube is primarily designed for receiving purposes but it can be successfully used in very low power transmitters. Its frequency range extends to 120 megacycles.

FilamentOxide Coated
 Plate Nickel
 Base Bakelite
 Bulb Soft Glass
 Plate Dissipation 0.7 watt
 Amplification Factor 8

CLASS C—TELEGRAPHY

SINGLE TUBE

| | | |
|--------------------------|-------|-------|
| E_r | 1.5 | volts |
| I_r | 0.06 | amp |
| E_p | 135 | volts |
| E_{c1} | -30 | volts |
| I_p | 7 | ma |
| I_{c1} | 1.8 | ma |
| R_{c1} (approx.) | 14000 | ohms |
| P_u | 0.6 | watts |

PUSH-PULL—TWO TUBES

| | | |
|--------------------------|------|-------|
| E_p | 135 | volts |
| E_{c1} | -30 | volts |
| I_p | 14 | ma |
| I_{c1} | 3 | ma |
| R_{c1} (approx.) | 7000 | ohms |
| P_u | 1.2 | watts |

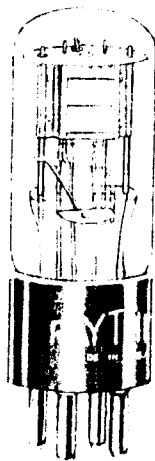

RK-43

The RK-43 is a twin triode which can be successfully used as an ultra high frequency push-pull oscillator in small, light-weight equipment. The filament voltage of this tube is 1.5 volts for operation from a single dry cell or flashlight battery. It can also be used as a combined super regenerative detector and a-f amplifier in small receivers. It has found particular favor as an oscillator for balloon weather equipment because of its light weight and low power requirements.

FilamentOxide Coated
 Plate Nickel
 Base Bakelite
 Bulb Soft Glass
 Plate Dissipation (per triode)..... 0.5 watt
 Amplification Factor 13

PUSH-PULL OSCILLATOR

| | | |
|--------------------------|------|-------|
| E_r | 1.5 | volts |
| I_r | 0.12 | amp |
| E_p | 135 | volts |
| E_{c1} | -20 | volts |
| I_p | 14 | ma |
| I_{c1} | 3 | ma |
| R_{c1} (approx.) | 7000 | ohms |
| P_u | 1.2 | watts |

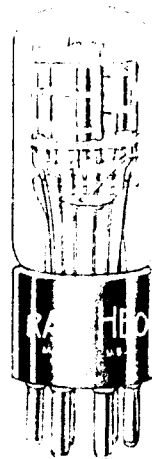

RK-24

The RK-24 is an improved type 30 for use in ultra high frequency transmitters and transceivers. It has an isolantite base to reduce high frequency losses and a larger filament to permit higher space currents and hence greater output than the type 30. It may be operated satisfactorily at the maximum ratings at 60 and 120 megacycles.

FilamentOxide Coated
 Plate Nickel
 Base Isolantite
 Bulb Soft Glass
 Plate Dissipation 1 watt
 Amplification Factor 8

CLASS C—TELEGRAPHY

SINGLE TUBE

| | | |
|--------------------------|------|-------|
| E_r | 2.0 | volts |
| I_r | 0.12 | amp |
| E_p | 180 | volts |
| E_{c1} | -45 | volts |
| I_p | 16.5 | ma |
| I_{c1} | 6.0 | ma |
| R_{c1} (approx.) | 7500 | ohms |
| P_u | 2 | watts |

PUSH-PULL—TWO TUBES

| | | |
|--------------------------|------|-------|
| E_p | 180 | volts |
| E_{c1} | -45 | volts |
| I_p | 33 | ma |
| I_{c1} | 12 | ma |
| R_{c1} (approx.) | 3750 | ohms |
| P_u | 4 | watts |

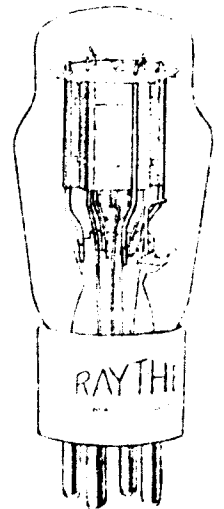

CLASS B AUDIO TUBES

Tubes for Class B audio service are usually very high-mu triodes to reduce the driving power requirement. If possible, they should operate at zero bias to eliminate the need for a bias supply. Usually, it is necessary to effect a compromise between high-current, low-voltage tubes for low load impedances and high-voltage, low-current tubes for good plate circuit efficiency.

RK-12

(See Illustration under R-F Power Amplifiers—Triode Section)

As Class B audio amplifiers two RK-12's are capable of modulating 200 watts of input to a Class C stage. The tubes operate at zero bias which eliminates the complications of a bias supply and minimizes driving power. The load resistance required is low which insures against low frequency attenuation in the output transformer. The use of RK-12's in Class B results in a very economical 100-watt amplifier.

| | | | | |
|--------------------------------------|--------------------|------------------------------------|------|-------|
| Filament | Thoriated Tungsten | A-F POWER AMPLIFIER—CLASS B | | |
| Plate | Carbonized Nickel | PUSH-PULL—TWO TUBES | | |
| Base | Isolantite | E_p | 750 | volts |
| Bulb | Soft Glass | E_{c1} | 0 | volts |
| Plate Dissipation | 25 watts | I_p | 200 | ma |
| Amplification Factor (approx.) | 80 | I_{c1} | 65 | ma |
| | | P_d | 3.4 | watts |
| | | R_L (P to P) | 9600 | ohms |
| | | P_u | 100 | watts |

RK-52

(See Illustration under R-F Power Amplifiers—Triode Section)

Two RK-52's are capable of modulating a Class C amplifier with 500 watts input. They operate at zero bias and have extremely low load resistance requirements. A modulator using two RK-52's is ideal for plate modulating two RK-48's in push-pull at the rated conditions.

| | | | |
|--------------------------------|--------------------|------------------------------------|------------|
| Filament | Thoriated Tungsten | A-F POWER AMPLIFIER—CLASS B | |
| Plate | Graphite | PUSH-PULL—TWO TUBES | |
| Base | Isolantite | E_p | 1250 volts |
| Bulb | Hard Glass | E_{c1} | 0 volts |
| Plate Dissipation | 60 watts | I_p | 300 ma |
| Amplification Factor (approx.) | 150 | I_{c1} | 180 ma |
| | | P_d | 7.5 watts |
| | | R_i (P to P) | 10000 ohms |
| | | P_o | 250 watts |

RK-31

(See Illustration under R-F Power Amplifiers—Triode Section)

The RK-31 is a double grid Class B tube capable of modulating 320 watts of input to a Class C amplifier. The double grid feature gives these tubes an unusually high power gain by reducing the driving power required.

| | | | |
|--------------------------------|--------------------|------------------------------------|------------------|
| Filament | Thoriated Tungsten | A-F POWER AMPLIFIER—CLASS B | |
| Plate | Molybdenum | PUSH-PULL—TWO TUBES | |
| Base | Isolantite | E_p | 1000 1250 volts |
| Bulb | Soft Glass | E_{c1} | 0 0 volts |
| Plate Dissipation | 40 watts | I_p | 220 230 ma |
| Amplification Factor (approx.) | 75 | I_{c1} | 76 65 ma |
| | | R_i (P to P) | 10000 18000 ohms |
| | | P_d | 3.7 4.4 watts |
| | | P_o | 160 190 watts |

RK-37 RK-38

(See Illustrations under R-F Power Amplifiers—Triode Section)

Although the RK-37 and RK-38 are primarily intended for radio frequency applications they may be successfully used as Class B modulators.

Two RK-37's will modulate 400 watts of input to a Class C amplifier while two RK-38's will modulate 660 watts and supply the highest Class B power output of any tubes in the Raytheon Amateur Line. The power gain of the RK-38 is unusually high for a tube of this general type.

RK-37

RK-38

| | | | |
|--------------------------------|--------------------|--------------------------------|--------------------|
| Filament | Thoriated Tungsten | Filament | Thoriated Tungsten |
| Plate | Tantalum | Plate | Tantalum |
| Base | Isolantite | Base | Isolantite |
| Bulb | Hard Glass | Bulb | Hard Glass |
| Plate Dissipation | 50 watts | Plate Dissipation | 100 watts |
| Amplification Factor | 30 | Amplification Factor | 30 |

| | | | | | |
|------------------------------------|-------|-------|------------------------------------|-------|-------|
| A-F POWER AMPLIFIER—CLASS B | | | A-F POWER AMPLIFIER—CLASS B | | |
| PUSH-PULL—TWO TUBES | | | PUSH-PULL—TWO TUBES | | |
| E_p | 1250 | volts | E_p | 2000 | volts |
| E_{c1} | -35 | volts | E_{c1} | -52 | volts |
| I_p | 235 | ma | I_p | 265 | ma |
| I_{c1} | 60 | ma | I_{c1} | 39 | ma |
| R_i (P to P) | 18000 | ohms | R_i (P to P) | 16000 | ohms |
| P_d | 7.2 | watts | P_d | 5.8 | watts |
| P_o | 200 | watts | P_o | 330 | watts |

MERCURY VAPOR RECTIFIERS

Rectifier tubes may be divided into two classes, those with a gas filling (usually mercury vapor) and high vacuum types. The mercury vapor tubes operate with a voltage drop of about 15 volts while that of the high vacuum types averages about 25 volts. The spacing between plate and cathode in the high vacuum types is smaller than in the mercury vapor types, hence they cannot be expected to withstand as high peak inverse voltages as the mercury vapor types. On the other hand, the high vacuum types operate without generating the radio frequency interference that the mercury vapor types sometimes produce. In addition, the high vacuum rectifiers are not affected by temperature variations.

866 866A 872A

(See Next Column)

The 866, 866A and 872A are half-wave mercury vapor rectifier tubes for use in d-c power supplies. The 866 will not stand the maximum peak inverse voltage of the 866A but will deliver the same d-c output current. The maximum peak inverse voltage of the 872A is the same as that of the 866A but the 872A will deliver considerably more d-c output current.

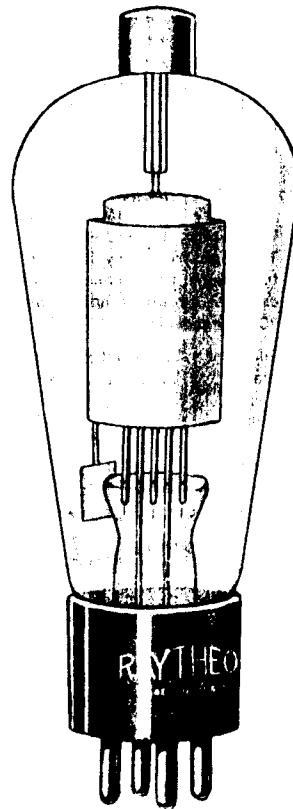

| | | |
|-----------------|-----|-------|
| E_r | 2.5 | volts |
| I_r | 5 | amp |

FULL-WAVE RECTIFIER—TWO TUBES

MAXIMUM RATING

| | | |
|--------------------------|--------------|------------------|
| | Choke | Condenser |
| | Input | Input |
| E_{ac} (RMS) | 3535 | 3535 volts |
| E_{dc} | 3180 | 3950 volts |
| I_{dc} | 500 | 250 ma |

866

| | | |
|-----------------|-----|-------|
| E_r | 2.5 | volts |
| I_r | 5 | amp |

FULL-WAVE RECTIFIER—TWO TUBES

MAXIMUM RATING

| | | |
|--------------------------|--------------|------------------|
| | Choke | Condenser |
| | Input | Input |
| E_{ac} (RMS) | 2650 | 2650 volts |
| E_{dc} | 2385 | 3000 volts |
| I_{dc} | 500 | 250 ma |

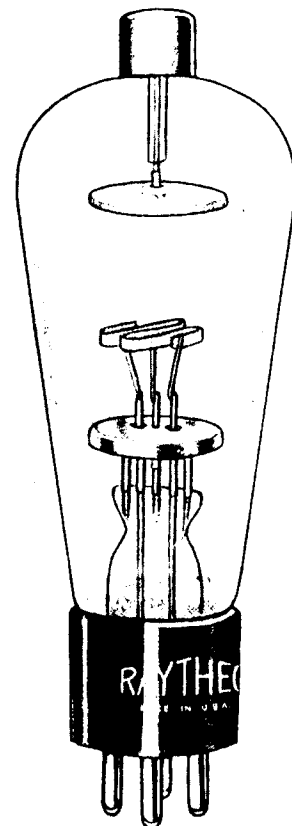

HIGH VACUUM RECTIFIERS

RK-19 RK-21 RK-22

The RK-19, RK-21 and RK-22 are high vacuum rectifier tubes for use in d-c power supplies delivering approximately 1000 volts d.c. Each of these tubes has a low internal voltage drop approaching that of mercury vapor type tubes and does not generate r-f noise.

The RK-19 and RK-22 are heater type full-wave rectifier tubes with 7.5 volt and 2.5 volt heaters respectively.

The RK-21 is a half-wave rectifier tube with a 2.5 volt heater and is equivalent to one diode of an RK-22.

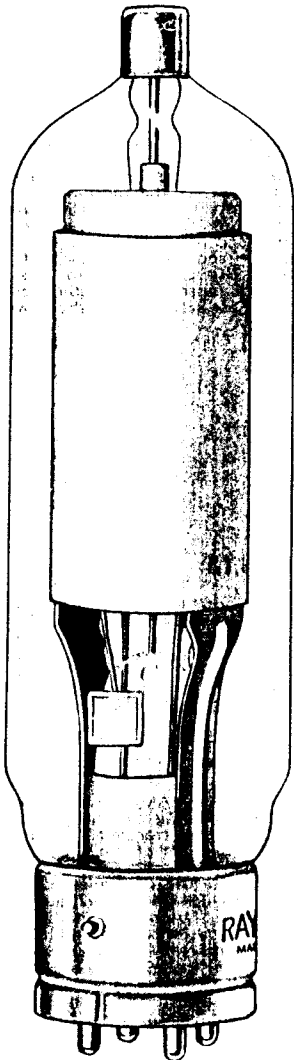

RK-19

E_r 7.5 volts
 I_r 2.5 amp

**FULL-WAVE RECTIFIER
 —ONE TUBE**

MAXIMUM RATING

| | | |
|----------------------------|--------------------|-------|
| | Condenser Input | |
| E_{ac} (RMS) (per plate) | 1250 | volts |
| I_{dc} | 150 | ma |

E_r 5 volts
 I_r 10 amp

**FULL-WAVE RECTIFIER
 —TWO TUBES**

MAXIMUM RATINGS

| | | | |
|--------------------|----------------|--------------------|-------|
| | Choke Input | Condenser Input | |
| E_{ac} (RMS) ... | 3535 | 3535 | volts |
| E_{dc} | 3180 | 3950 | volts |
| I_{dc} | 2.5 | 0.6 | amp |

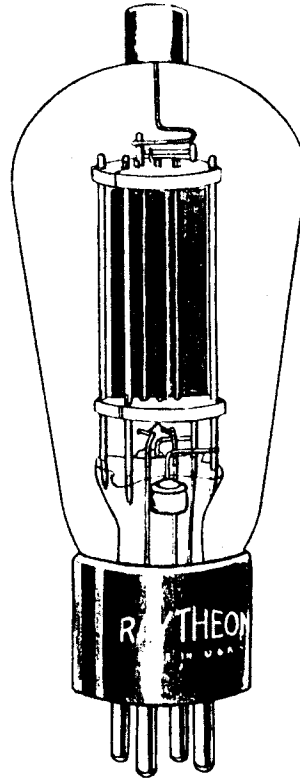

RK-21

E_r 2.5 volts
 I_r 4 amp

**HALF-WAVE RECTIFIER
 —ONE TUBE**

MAXIMUM RATING

| | | |
|----------------------|--------------------|-------|
| | Condenser Input | |
| E_{ac} (RMS) | 1250 | volts |
| I_{dc} | 150 | ma |

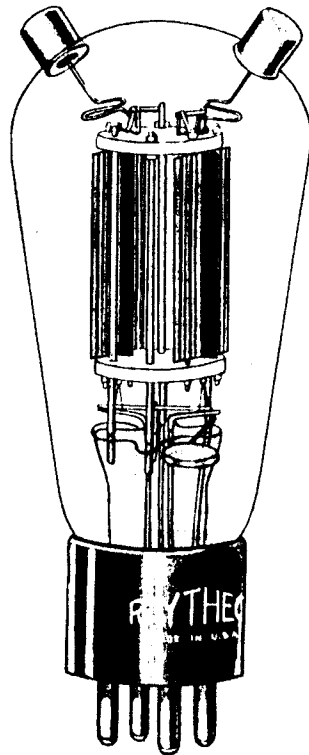

RK-22

E_r 2.5 volts
 I_r 8 amp

**FULL-WAVE RECTIFIER
 —ONE TUBE**

MAXIMUM RATING

| | | |
|---------------------------|--------------------|-------|
| | Condenser Input | |
| E_{ac} (RMS) per plate) | 1250 | volts |
| I_{dc} | 150 | ma |

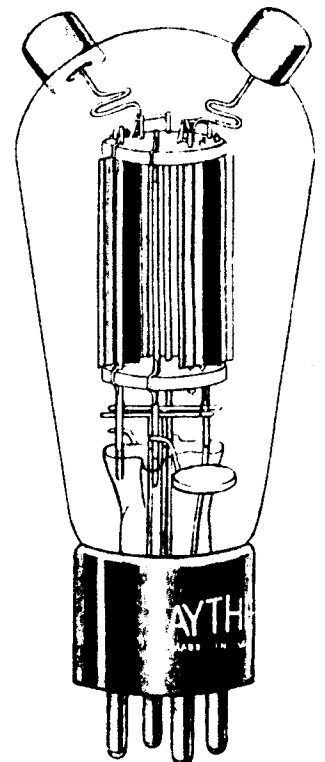

TUBE MANUFACTURE

Fundamentally there are three main steps in the manufacture of tubes, mechanical fabrication and assembly of the parts, preliminary cleaning and degassing of the parts, exhausting and other processing of the assembled tube.

PARTS PREPARATION The first assembled part of the radio tube is the glass stem upon which the tube elements are later to be supported. A short length of large diameter glass tubing first has one end flared out for subsequent sealing to the neck of the bulb. Then the straight end of this tube is placed over the metal supports and lead wires and over a smaller glass tube through which the gases will be later pumped out of the bulb.

Gas flames are applied to the straight end of the glass stem and when the glass becomes soft and molten, it is pressed tightly around the wires, making a vacuum tight seal. At the same time the exhaust tube is sealed in so that the gases in the bulb can be later pumped out through it.

Molybdenum, nickel, tantalum and tungsten are formed into the familiar tube parts, plates, shields, supporting wires, etc. as a second operation. The grids are made by winding molybdenum or tantalum wire around a form and then electrically welding each wire securely to the heavy grid support leads. After these parts have been completed they are inspected for size, shape, uniformity and appearance and are surface cleaned by dipping in a series of solvents and chemicals to remove the oils and surface films. Next the parts are furnace treated in a hydrogen atmosphere or in a vacuum. They are held at an incandescent temperature for sufficient time to drive off the gases which have been present in the metal since its manufacture and when removed from the furnace they are both spotless and gas free. The insulators such as mica, lava and magnesia are inspected for mechanical imperfections and then heat treated at the required temperature to remove a maximum of gas without altering the composition of the material.

ASSEMBLY The final assembly upon the glass stem of the grid, plate, filament, spacers and insulators is known as the "mount assembly". Trained operators spot-weld together the various tube elements by holding the parts between the jaws of a pressure type electric welder. Perfect alignment of each part is assured by the use of jigs and fixtures that hold the parts in the proper relation and keep them from moving while the weld is being made. The parts are never touched by the fingers during these operations and every effort is made to prevent moisture, oil or dust from contaminating the metal surfaces.

A last careful inspection of the mount is made, it is slid inside the glass envelope and placed on the sealing machine. Gas and oxygen flames are applied to the neck of the bulb while the bulb and mount are rotating together. The bulb neck becomes molten and shrinks into contact with the flared end of the glass stem of the mount assembly and as the two melt together the bulb neck is cut off and the seal worked to insure a good joint. After a slow annealing and cooling, the tube for the first time presents an almost finished appearance, all its internal parts are in place inside the glass bulb, the only remaining opening being the small bore of the exhaust tube.

EXHAUST The exhaust process is the series of treatments during which the tube is pumped free of air, the inner parts given a final heat treatment and degassing and the tube permanently sealed air tight. During the process every possible molecule of gas is driven from the metal parts, the insulators, the glass stem and the bulb by subjecting them for long periods to as high temperatures as the parts will stand. When the exhaust is complete the tube is gas free and will continue to be gas free even though overloads cause the plate and grids to reach relatively high temperatures.

A typical exhaust apparatus for amateur high vacuum tubes includes a motor driven, oil immersed, vacuum pump, a mercury vapor pump, liquid air impurity traps, a power supply capable of delivering filament, grid and plate potentials at any desired voltage and current and a large radio frequency generator or "bombarder". The tube to be exhausted has its exhaust tube heated and sealed onto the glass manifold connected to the mercury vapor pump. After a check to insure that all connections throughout the glass system are vacuum tight the pumps are started and the air is soon removed from the tube.

The filament is now carbonized and activated in order that it may be ready to supply an abundance of electrons for the exhaust process to follow. Initially the filament is made up of pure tungsten wire within which a small percentage of thorium oxide has been compounded. In order to give this wire the emitting properties of thoriated tungsten, the filament is flashed at a very high temperature (2500°C) for a short time, then lighted in an atmosphere of hydrocarbon gas such as acetylene, pyrofax or coal gas. Carbon from the hydrocarbon gas is absorbed by the tungsten wire and helps to reduce the thorium oxide to metallic thorium. This thorium diffuses between the tungsten crystals to the surface of the wire and becomes the active emitting area with an emissivity about 1000 times that of pure tungsten wire. The gas is pumped out and the filament is lighted at approximately 1700°C long enough for a state of equilibrium to be reached.

Next, the tube is enclosed in an oven and baked at just below the temperature at which the glass walls of the tube would soften and collapse. The vacuum pumps operate steadily during the bulb baking, removing the gases freed from the glass walls of the bulb. Now the oven is removed and the process of heat treating the metal parts begins. A coil made of copper tubing and approximately the size of a 40 meter tank inductance is next slid up around the center of the tube. This coil is part of the tank circuit of a 3 kilowatt oscillator and through it circulates an r-f current of the order of a hundred amperes. The metal parts in this intense r-f field heat red, yellow and then white hot. At first the tube is blue with the occluded gas driven from the metal by the high temperature and ionized by the strong r-f field. Soon, however, this gas is drawn off by the vacuum pumps and after sufficient treatment the gas pressure is reduced to a very low value. The r-f coil is then removed and the tube filament is lighted and the grids and plate are connected to high voltage power supplies. The operator, wearing black glasses to protect his eyes from the glare of the white hot tube and standing behind a safety glass screen, slowly raises the voltage on each element. A faint blue cloud of ionized gas may again be seen when the temperature exceeds that of the r-f heat treatment. This gas is pumped away and the temperature raised until finally at the highest temperatures no sign of gas is present. With the parts at this incandescent temperature the tube is cooked for some time with the pumps operating to withdraw the last traces of gas liberated from the innermost parts of the metal and from the bulb wall. Finally the process is completed and the voltages removed.

If the tube contains a getter pellet, the r-f coil is slid into position to heat the getter container. At a red heat the barium or other chemically active metal in the getter vaporizes and condenses on the bulb wall. A large proportion of the few remaining gas molecules in the tube combine with the getter and are held in inactive form. This getter deposit will remain active indefinitely and as gas molecules from the grid and plate metals or the glass or insulator surfaces free themselves slowly during tube operation, they will be caught by the remaining active getter. A small, sharp pointed flame is next applied to the small exhaust tube and as the glass at this point is melted the completed radio tube is pulled away from the manifold and sealed off vacuum tight.

The base and the metal caps for the tube are filled with a special cement and the lead wires threaded into the correct base prongs. The base and cap cement is hardened and baked into place in a small baking oven. The lead wires are next cut and soldered carefully to the base pins and the top cap.

SEASONING AND TESTING The tube is not yet completely ready for service. The filament has been lighted at overvoltage during the element heating process and in the presence of some gas. In order to assure full electron emission, every part of the filament must be clean and active and so, as the next treatment, the filament activation and stabilizing is performed. During the stabilizing or "aging" process the filament is operated first at an abnormally high temperature to clean the surface and to accelerate the diffusion of thorium to the surface and then for a considerable length of time at normal temperature until a state of equilibrium in the filament is achieved with the surface of the filament fully coated with active thorium.

Mechanical and electrical inspections are the last operations. Tubes are checked by skilled operators for length, appearance, loose particles, and mechanical imperfections. The filament is lighted and the alignment of the grids and other structure is checked. A tube which passes the mechanical test is next due for a complete electrical performance test. If the tube is intended for r-f service, it is set up at rated voltages in a Class C amplifier test set. The input, output, element currents, driving power and plate dissipation are noted. A check is made for gas, interelement leakage and emission. Each of these tests is made to a predetermined set of limits. Tubes that fail to pass these limits are set aside and scrapped. Unless a tube passes every requirement the bulb is broken up, the more valuable metal parts are salvaged and the remainder is junked.

TUBE ELEMENTS

A radio tube, or vacuum tube, is a vacuum device in which electric current flows as a stream of electrons through the evacuated space from one electrode to another. A HIGH VACUUM TUBE is one in which the degree of vacuum is so high that the characteristics of the tube are not affected by gas ionization. Most radio transmitting tubes are of this class. A GAS TUBE is one which has a gas filling, usually at relatively low pressure, and in which gas ionization is essential to the normal operation of the tube. Types 866 and 872A are examples of this class.

CATHODE The cathode is the electrode which supplies the electrons necessary for the operation of the tube. In general the cathode must be heated to obtain sufficient emission of electrons. A FILAMENTARY CATHODE is in the form of a wire or ribbon through which heating current flows and is sometimes called a "directly heated" cathode. In most transmitting tubes and particularly in high power tubes, the cathode is a filament of thoriated tungsten and is normally operated at a temperature of approximately 1700° Centigrade. The RK-20A and RK-36 are typical examples of the use of thoriated tungsten filament. A few transmitting tubes, such as the RK-24, RK-42 and RK-43 utilize what are known as oxide coated filaments. The cathode in these types consists of a ribbon or wire coated with the oxides of barium and strontium and is operated at relatively low temperatures, normally between 600° and 800° Centigrade. Tubes like the RK-23, RK-25 and RK-39 use a uni-potential or indirectly heated cathode consisting of a metal sleeve, usually nickel, which encloses an insulated filament or heater through which the heating current flows. The cathode sleeve is coated with oxides of barium and strontium and is operated at temperatures between 600° and 800° Centigrade.

PLATE The plate, or anode, is the electron collector element of a tube and is normally the one to which the main portion of the electron stream flows. It is usually in the form of a cylinder of thin metal and may be circular, oval or rectangular in cross-section. Several different plate materials are in general use in transmitting tubes and each has its own peculiar advantages. This subject of transmitting tube plates is more completely covered under "Tube Materials". Tubes like the RK-20A, RK-18, RK-31, etc. have sandblasted molybdenum plates. The RK-10, RK-11 and RK-39 have carbonized nickel plates. The RK-51 and 52 use carbon or graphite plates while the plates of tubes like the RK-32, RK-36, etc. are of tantalum.

GRID A grid is an auxiliary electrode placed between the cathode and the plate and is of such form that the electron stream can flow through it. It usually consists of a spiral of wire fastened at each turn to one or more, usually two, longitudinal support wires. In cross-section, the outline of a grid may be circular, oval or rectangular. Grids supported at only one end, such as are used in the larger tubes of the RK-36, RK-37 class, use a cage construction that greatly increases the strength of the grid and is effective in reducing grid vibration. The grids in a multi-grid tube are commonly referred to by numbers indicating their position radially with respect to the cathode, number 1 grid being adjacent to the cathode. A CONTROL GRID, or input grid, is one to which an input signal voltage is applied and which modulates the main electron stream in accordance with the input signal. A SCREEN GRID is an auxiliary grid placed between the control grid and the plate and operated at a positive d-c voltage with respect to the cathode. Besides accelerating the electrons toward the plate, a screen grid acts as an electrostatic shield and reduces the capacity between the plate and the control grid. A SUPPRESSOR GRID is a grid placed between the screen grid and the plate and connected to a point of low d-c potential to prevent the passage of low velocity secondary electrons originating either at the plate or at the screen grid. In some types it is connected internally to the cathode and in others it is connected to a separate base pin.

The term ALIGNED GRID refers to a pair of adjacent grids having the same number of turns per inch and placed so that each turn of one grid lies in the same horizontal plane with the corresponding turn of the adjacent grid. The grids usually aligned are the control grid and the screen grid in some tetrode and pentode power amplifier tubes. This arrangement causes the electrons to flow in flat beams between successive turns of the aligned grids. Since the screen grid wires are out of the direct path of the electrons, fewer electrons reach the screen grid and the screen grid current is lower than that of similar tubes without aligned grids. This permits more efficient utilization of the total space current since much of the current that was formerly collected by the screen grid is now available for the plate.

This improvement in characteristics results from the effect of the suppressor grid, #3 grid, which prevents the passage of secondary electrons between the plate and the screen grid. The plate current curves are flatter than those of corresponding types of tetrodes except beam power tubes, hence the plate resistance and amplification factor are correspondingly higher. Pentodes may be used for the same service as tetrodes and have the advantages of even lower grid to plate capacitance and of high amplification factor and plate resistance. In addition, since the plate current curves are smooth over a wide range of plate voltage, pentodes can be operated as power amplifiers at large amplitudes of a-c voltage and current.

In low frequency amplifiers the successive stages may be transformer coupled or resistance coupled. Transformer coupling is generally used with low- μ triodes and resistance coupling with high- μ triodes, tetrodes or pentodes. Fig. B3 shows a typical resistance coupled a-f amplifier stage using a triode and Fig. B4 shows a resistance coupled a-f pentode stage.

An amplifier stage may use one tube or two tubes connected in parallel or in push-pull. In a PUSH-PULL AMPLIFIER stage the two tubes are connected in

TUBE APPLICATION AND CIRCUITS

RECTIFIERS In the application of rectifier tubes care should be taken that the published maximum ratings are not exceeded. Rectifier tubes are rated for **MAXIMUM A-C PLATE VOLTAGE**, the maximum rms value of a-c voltage that should be applied to the plate of the tube and for **MAXIMUM D-C OUTPUT CURRENT**, the highest value of d-c plate current, averaged over one a-c cycle, at which the tube should be operated. They are also rated for **MAXIMUM PEAK PLATE CURRENT**, the maximum instantaneous peak value of plate current that should be permitted to flow through the tube and for **MAXIMUM INVERSE PEAK VOLTAGE** which is the maximum instantaneous peak value of plate voltage that should be applied to the tube during the half-cycle when the plate is negative and the tube is not conducting current. The **VOLTAGE DROP** is the d-c plate voltage corresponding to some specified value of d-c plate current, usually equal to the maximum d-c output current per plate.

A typical half-wave rectifier circuit is shown in Fig. B1 and a typical full-wave rectifier circuit in Fig. B2. A condenser input filter is shown in each circuit. If C_1 were omitted the filter would be a choke input filter. With condenser input the d-c output voltage will be higher and the regulation over the working range poorer than with choke input. Increasing the capacity of C_1 will increase the d-c output voltage but will also increase the peak plate current. Some filter circuits employ two chokes in series, as shown in Fig. B2 to further reduce the hum voltage.

TYPICAL HALF WAVE RECTIFIER CIRCUIT

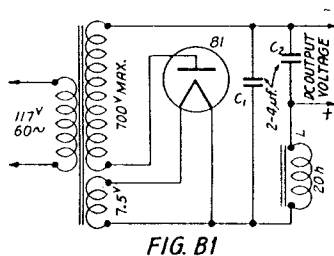

FIG. B1

TYPICAL FULL WAVE RECTIFIER CIRCUIT

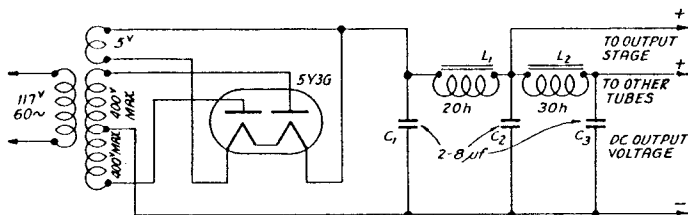

FIG. B2

AMPLIFIERS Vacuum tubes operate as amplifiers in several ways. Although the fundamental principle of the amplifier remains unchanged, the results obtained and their applications are quite different. In general, amplifiers may be divided into two groups. The first group consists of low frequency power or voltage amplifiers and high frequency voltage amplifiers. The second group consists of radio frequency power amplifiers. The operation of the first group is characterized by relatively low efficiencies and low distortion, while the second group operates at very high efficiencies and high distortion. Amplifiers of the low frequency, low distortion type will be first considered.

TYPICAL RESISTANCE COUPLED A-F AMPLIFIER CIRCUITS

TRIODE

PENTODE

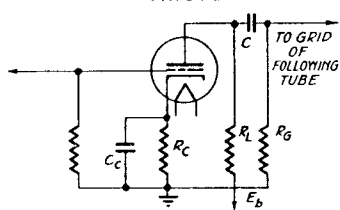

FIG. B3

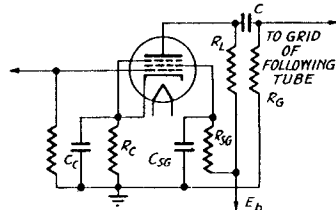

FIG. B4

TYPICAL PUSH-PULL POWER AMPLIFIER—CLASS AB₂

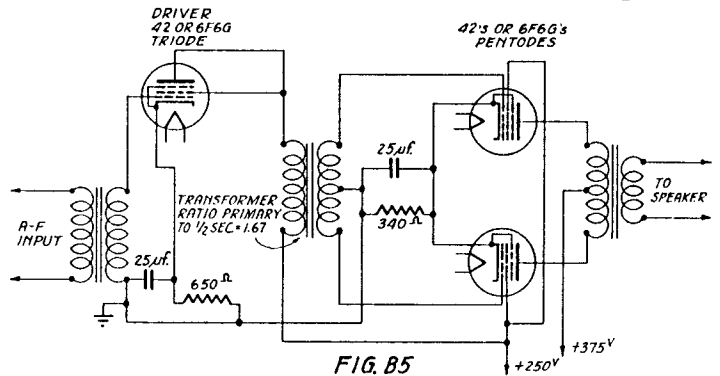

FIG. B5

such a way that the two grid circuits are effectively in series and the two plate circuits likewise. Equal signal voltages 180° out of phase are applied to the two grids by a center-tapped transformer or by a phase inverter circuit. The a-c plate currents and voltages are combined in the output circuit to give approximately twice the power output obtainable from a single tube operating under the same conditions and the second and other even order harmonics cancel out. Fig. B5 shows a typical push-pull power amplifier stage transformer coupled to a driver stage. Transformer coupling is used where power is supplied to the push-pull grids as in Class AB or Class B operation. Either transformer or phase inverter input may be used where the output stage requires no appreciable driving power.

A PHASE INVERTER circuit is shown in Fig. B6. The signal voltage for triode R is obtained from the tap, P, on the resistor, R_k , in the

TWIN TRIODE PHASE INVERTER

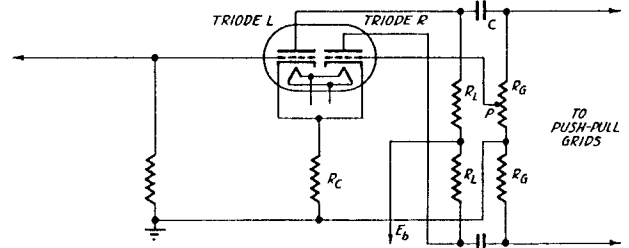

FIG. B6

output circuit of the other triode. This tap should be adjusted so that the signal voltage applied to triode R is equal to the input signal on the grid of triode L. For example, if the voltage gain of triode L is 25, the tap, P, should be adjusted to supply 1/25 of the voltage across R_k to the grid of triode R.

CLASS A AMPLIFIERS Amplifier stages are classified with respect to the tube operating conditions and the relation between the grid bias and the maximum normal value of a-c signal voltage, which determine the fraction of the a-c cycle during which the plate current flows. In a CLASS A amplifier stage, the plate current flows during the complete a-c cycle, the grid bias usually being fixed at approximately one-half of the cutoff bias, the grid bias necessary to reduce the plate current to practically zero. Ordinarily the maximum normal peak value of the a-c signal voltage is approximately equal to the grid bias and no grid current flows during any portion of the cycle, although this is not a necessary condition for CLASS A operation. The subscript 1, as in Class A₁, is sometimes used to indicate that no grid current flows during any part of the input cycle.

Fig. B7 shows the section of the plate current vs. plate voltage family of a triode operated as a CLASS A amplifier. THE LOAD LINE represents the relation between the instantaneous values of grid voltage, plate voltage and plate current during a cycle. Its slope is numerically equal to the reciprocal of the effective a-c impedance in the external plate circuit. Since this impedance is chiefly resistive, it is commonly referred to as the LOAD RESISTANCE, R_L . The operating point, O, indicates the static values of plate voltage, E_o , and current, I_o , with no signal. The load line terminates at plate current curves corresponding to the maximum and minimum instantaneous values of grid voltage at full rated signal, the swing in grid voltage being the same in either direction from the operating point, O. The difference between the plate voltage at the operating point and that at either end of the load line equals approximately the peak value of the a-c output voltage developed across the load resistance. The rms value of the a-c output voltage will be 0.707 times the peak voltage obtained from the curves. The power output may then be calculated approximately from the relation:

$$\text{Power Output} = \frac{(E_{RMS})^2}{R_L} = \frac{0.707 (E_{max} - E_u)^2}{R_L} = \frac{0.707 (E_o - E_{min})^2}{R_L} \quad (BII)$$

A more accurate formula which includes both halves of the cycle is:

$$\text{Power Output} = \frac{(E_{max} - E_{min}) (I_{max} - I_{min})}{8} \quad (BIII)$$

The values of E_{max} , E_{min} , I_{max} and I_{min} are read from the curves as shown in Fig. B7. If the values of E_{max} and E_{min} are expressed in volts, the values of I_{max} and I_{min} should be expressed in amperes to give the power output in watts.

The second harmonic distortion, expressed in percent, may be calculated from the formula:

$$\text{2nd Harmonic} = \frac{I_{max} + I_{min} - I_o}{I_{max} - I_{min}} \times 100 \quad (BIV)$$

I_o is the value of d-c plate current at the operating point and is read from the curves. All the values of current in equation (BIV) should be expressed in the same units, milliamperes or amperes. Fig. B8 shows typical variations of power output, plate current and harmonic distortion with signal input voltage for a triode operated as a Class A amplifier. The power output varies approximately as the square of the input voltage and the distortion is low and is chiefly second harmonic.

The PLATE EFFICIENCY is the percentage ratio of the power output to the product of the average d-c plate voltage and d-c plate current at full signal.

$$\text{Plate Eff. (\%)} = \frac{P_o}{E_p I_p} \times 100 \quad (BV)$$

In a Class A triode amplifier the plate efficiency is relatively low, 15% to 25%.

The POWER SENSITIVITY is the ratio of the power output to the square of the input signal voltage, E_g .

$$\text{Power Sensitivity} = \frac{P_o}{(E_g)^2} \quad (BVI)$$

The method of calculating the approximate power output and distortion for a pentode or a tetrode, operated as a Class A amplifier, is similar to that for triodes. Fig. B9 shows a family of plate characteristic curves for a typical pentode Class A amplifier. The power output may be calculated approximately from the formula:

$$\text{Power Output} = \frac{[I_{max} - I_{min} + 1.41 (I_x - I_y)]^2}{32} \frac{E_{max} - E_{min}}{I_{max} - I_{min}} \quad (BVII)$$

The values are read from the curves at the points indicated in Fig. B9. The values of I_x and I_y are determined by the intersections of the load line with plate current curves corresponding to grid biases of 0.293 E_{g0} and 1.707 E_{g0} respectively, where E_{g0} is the value of the grid bias at the operating point, 0.

The second harmonic distortion, expressed in percent, may be calculated from the formula:

$$\text{2nd Harmonic} = \frac{I_{max} + I_{min} - 2 I_o}{I_{max} - I_{min} + 1.41 (I_x - I_y)} \times 100 \quad (BVIII)$$

The third harmonic distortion, in percent, is given by the formula:

$$\text{3rd Harmonic} = \frac{I_{max} - I_{min} - 1.41 (I_x - I_y)}{I_{max} - I_{min} + 1.41 (I_x - I_y)} \times 100 \quad (BIX)$$

Fig. B10 shows the variation of power output, plate current, screen current and distortion with signal input voltage and Fig. B11 shows the variation of the same quantities with load resistance for a typical pentode Class A amplifier. A pentode is normally operated with a load resistance of approximately

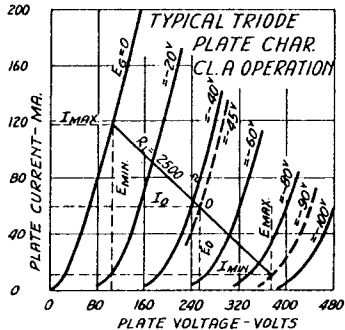

FIG. B7

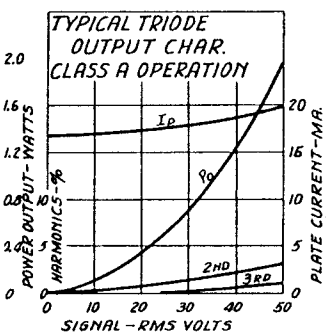

FIG. B8

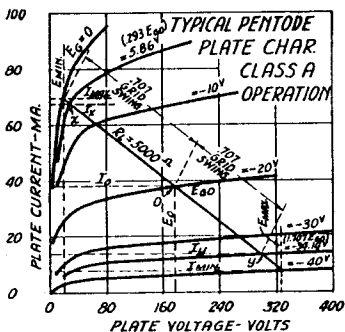

FIG. B9

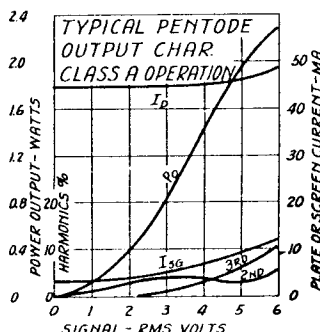

FIG. B10

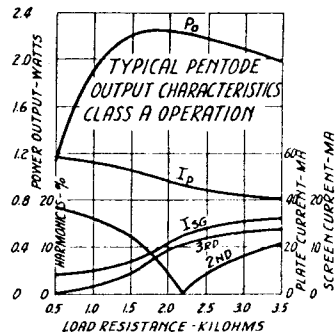

FIG. B11

the value at which the second harmonic is a minimum. In some cases, the load resistance is adjusted for a lower value of third harmonic and the second harmonic is balanced out by using two tubes in push-pull or by introducing a balancing amount of second harmonic in a preceding stage. Beam power tubes are frequently operated with lower values of load resistance than are pentodes to reduce the odd harmonic distortion. A Class A pentode amplifier generally has higher plate efficiency, 35% to 45%, and higher power sensitivity than a Class A Triode. The distortion is also generally higher and consists mostly of third and higher odd harmonics.

CLASS B AMPLIFIERS In a Class B a-f amplifier stage two tubes or the two sections of a twin tube are used in a push-pull circuit. The grid bias is fixed at approximately the cutoff value and plate current flows in each plate circuit on alternate half-cycles of signal voltage when the grid is positive. Since the grid of a Class B tube is swinging positive during a considerable portion of the cycle, grid current usually flows for part of the cycle. This grid voltage and current represent power which must be supplied by the preceding tube called the DRIVER TUBE. The power output of the driver tube is often the limiting factor in determining the power output of a Class B stage. Since the average plate current of a Class B stage varies considerably with signal voltage, the plate voltage supply should have good regulation to prevent excessive decrease in d-c plate voltage and limitation of output as the signal voltage is raised.

Fig. B12 shows the section of the plate current vs. plate voltage family of a triode used as a Class B amplifier. In Class B operation the plate current of one tube is practically cut off during each alternate half-cycle and contributes very little to the power output. The power output from the two tubes may be calculated approximately from the plate family of one tube and is equal to the sum of the power outputs represented by the extensions of the load line on either side of the operating point, 0.

$$\text{Power Output} = \frac{(E_o - E_{min}) (I_{max} - I_o)}{2} + \frac{(E_{max} - E_o) (I_o - I_{min})}{2} \quad (BX)$$

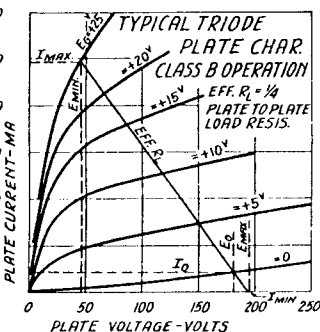

FIG. 12

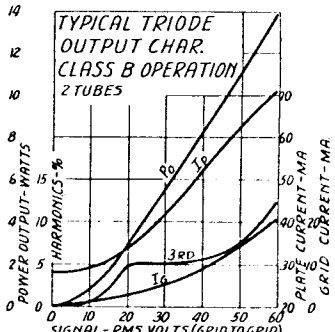

FIG. 13

Since the plate current of one tube is practically cut off during each alternate half-cycle, formula (BX) may be reduced to a further approximation.

$$\text{Power Output} = \frac{(E_o - E_{min}) I_{max}}{2} \quad (BXI)$$

The actual power output is somewhat higher than that shown by these relations because of the effects of the third and other odd harmonics. Fig. B13 shows typical variations of power output, plate current and distortion with signal input voltage for a Class B a-f amplifier. The distortion is chiefly third and other odd harmonics. The plate efficiency, 50% to 65%, and the power sensitivity at full power output are both relatively high.

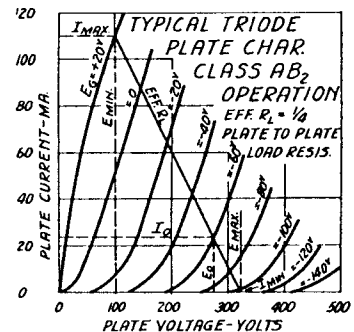

FIG. 14

CLASS AB AMPLIFIERS A Class AB amplifier stage is one which operates under conditions intermediate between Class A and Class B. The grid bias is fixed at a value between that for Class A operation and cutoff and plate current flows in each plate circuit for less than one complete cycle but for more than one half-cycle of the signal voltage. If the normal maximum peak value of the signal voltage does not exceed the grid bias and no grid current flows during any part of the input cycle, the amplifier may be designated as Class AB₁. If grid current flows during any portion of the input cycle the amplifier may be designated as Class AB₂. Fig. B14 shows the section of the plate current vs. plate voltage family of a triode used as a Class AB₂ amplifier. The power output from the two tubes may be computed approximately from the plate family of one tube in the same manner as for Class B operation. The characteristics of power output, plate current, plate efficiency and plate current fluctuations with signal and driving power are intermediate between those of Class A and Class B operation. Power output pentodes or tetrodes may be used as Class B or Class AB amplifiers, and the approximate power output may be computed from the plate current vs. plate voltage curves in the same way as in the case of triodes.

CLASS B R-F AMPLIFIERS Class B R-F Amplifiers are closely allied with Class B audio amplifiers. Class B R-F Amplifiers are used to amplify an already modulated wave. Since such a wave is modulated up to twice its carrier value and down to zero, Class B R-F Amplifiers must be capable of reproducing this wave in the plate circuit, which in turn requires that the grid of the Class B stage be biased at cutoff or slightly less than cutoff for the plate voltage used. For Class B R-F operation but one tube is required since the symmetry of the modulated wave is restored by the presence of the tuned tank load.

CLASS C AMPLIFIERS R-F power amplifiers are usually operated as Class C amplifiers. The designation, Class C, is intended to describe an amplifier which is operated in such a manner that plate current is completely cut off over a large part of the cycle. The grid bias must, therefore, be larger than the cutoff value for the plate voltage used. The presence of harmonics in the plate circuit is largely ironed out by the use of a tuned load or tank circuit. The phase relations are such that plate current flows only when the plate voltage is relatively low resulting in high plate efficiency. The calculation and operating practice with regard to Class C amplifiers is discussed more completely under "Grid Driving Power and the Exciter" and "Output Impedance and L/C Ratio".

TYPICAL SPEECH AMPLIFIER AND DRIVER FOR CLASS B MODULATORS

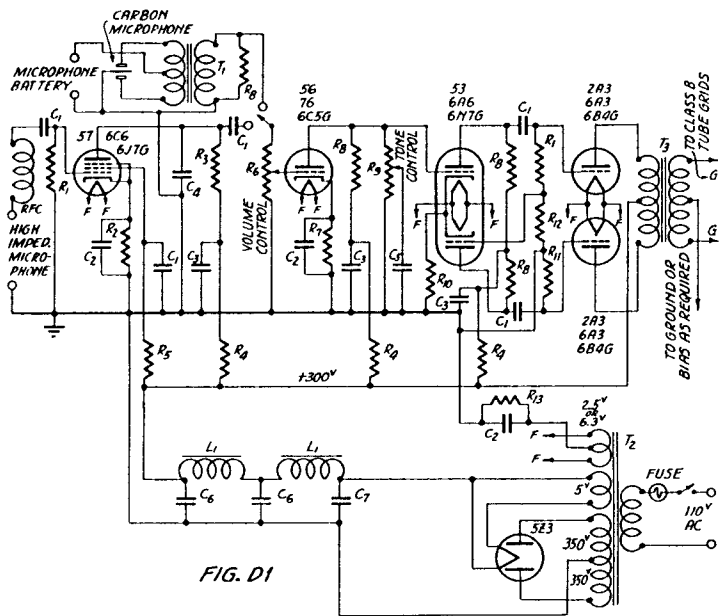

FIG. D1

- R₁ Depends on characteristics of microphone
 - R₂ 1200 ohms 1/3 watt
 - R₃ 0.5 megohm 1/3 watt
 - R₄ 20000 ohms 1/3 watt
 - R₅ 1 megohm 1/3 watt
 - R₆ 0.5 megohm variable
 - R₇ 6000 ohms 1/3 watt
 - R₈ 0.1 megohm 1/3 watt
 - R₉ 0.25 megohm variable
 - R₁₀ 3000 ohms 1/3 watt
 - R₁₁ 0.25 megohm 1/3 watt
 - R₁₂ 12000 ohms 1/3 watt
 - R₁₃ 780 ohms 10 watts
 - C₁ 0.05 microfarad paper
 - C₂ 25 mfd. 50 volt electrolytic
 - C₃ 8 mfd. 400 volt electrolytic
 - C₄ 0.00004 microfarad mica
 - C₅ 0.005 microfarad mica
 - C₆ 8 mfd. 600 volt electrolytic
 - C₇ 4 mfd. 600 volt electrolytic
 - L₁ 30 H 200 ohms 100 ma. choke
 - T₁ Microphone input transformer
 - T₂ Power Transformer
350 volts—0—350 volts—100 ma.
2.5 volts 8 amp. 5 volts 3 amp.
or
6.3 volts 4 amp.
 - T₃ Output Transformer
2A3 or 6A3 plates to Class B grids or to 500 ohm line
- | Modulator Tubes | Turns Ratio Pri. to Sec. |
|-----------------|--------------------------|
| RK-12 | 1.4:1 |
| RK-52 | 1.4:1 |
| RK-31 | 1.4:1 |
| RK-38 | 1:1.4 |
| RK-37 | 1:1 |

The amplifier circuit in Fig. D1 is an inexpensive and an effective one for use as a speech amplifier or as a driver for Class B modulator tubes. The power output of the amplifier is 10 watts which is more than ample to drive the grids of any of the Raytheon Class B modulator tubes. If the amplifier is intended for use with a double button carbon microphone the 57 stage may be eliminated and the carbon microphone fed directly through its coupling transformer to the 56 grid.

The output transformer may be the one indicated or one to match the 2A3 plates to a 500 ohm line or to a dynamic speaker if the amplifier is to be used for power amplifier work.

If 6.3 volt tubes are desired they may be used as indicated.

The full power output of the amplifier is considerably more than is necessary to drive two RK-12 grids. The amplifier in this case may either be run at very reduced gain or the 2A3's may be replaced with lower power triodes such as type 45's.

GRID DRIVING POWER AND THE EXCITER

The question of grid driving power has long been important to the active amateur. For example, suppose that an RK-30 output stage is to be replaced by one using an RK-37. The RK-30 has been operating at the typical operating conditions as given in the data sheet, that is, a plate voltage of 1250 volts, a plate current of 90 milliamperes and a power output of approximately 85 watts. The grid driving power required was 5 watts. The RK-37 may be used at a plate voltage of 1500 volts and from the Class C data, will deliver an output of 105 watts with the same driving power as the RK-30. On this basis, the original exciter used for the RK-30 might be considered adequate to drive the RK-37. Suppose, however, that the grid coupling device and the exciter circuit were just able to supply the necessary driving power to the RK-30. If an attempt is made to drive the RK-37 with the same coupling device and exciter, it may be found that the grid current of the RK-37 is low and the tube is delivering very little power output. Perhaps the grid of the RK-30 had been supplied originally from a heavily loaded crystal oscillator, which now refuses to oscillate at all. If the grid of the RK-37 is tapped down on the oscillator tank coil or the coupling system is changed, the RK-37 can be made to drive readily. It seems that there is another factor that should be considered when grid driving power and the exciter are discussed and this factor is the grid impedance. It is the magnitude of the grid impedance that determines, for a given power input, the r-f voltage that must be applied to the amplifier grid, which in turn determines the coupling to the exciter.

THEORY OF GRID DRIVING POWER In Fig. F1 some r-f voltage has been applied to the grid of a Class C amplifier tube. This voltage contains only a small harmonic content since it is being supplied from a tuned tank circuit that has almost completely ironed out the harmonics that were present in the plate current of the driver tube. The grid of the amplifier tube will draw current only when the instantaneous voltage of the grid is positive with respect to the cathode. Since the peak r-f voltage supplied is 125 volts and the bias is -100 volts the grid will draw current only as long as the r-f voltage is greater than 100 volts, but over a very large part of the cycle the grid current will be zero. Therefore, the grid current will flow in very short pulses near the positive peaks of the applied r-f voltage. Over each cycle of the exciting voltage these grid current pulses can be shown to consist of a d-c component, a fundamental component, and harmonic components, as shown in Fig. F2. If the shape of the grid current vs. grid voltage curve is known, the values of any of these components can be calculated. Furthermore, if the grid current is assumed to be operating over a known curve, the relative values of the grid current components are fixed and if one component can be measured the rest can be found by simple proportion. Fortunately, the d-c component is easily measured for it is the current that is read on a d-c milliammeter in the grid circuit. The value of the fundamental component with respect to the d-c component varies with the law over which the grid current operates and with the length of the current pulse. The length of the current pulse can be obtained from Fig. F3 or Fig. F4, knowing the peak r-f

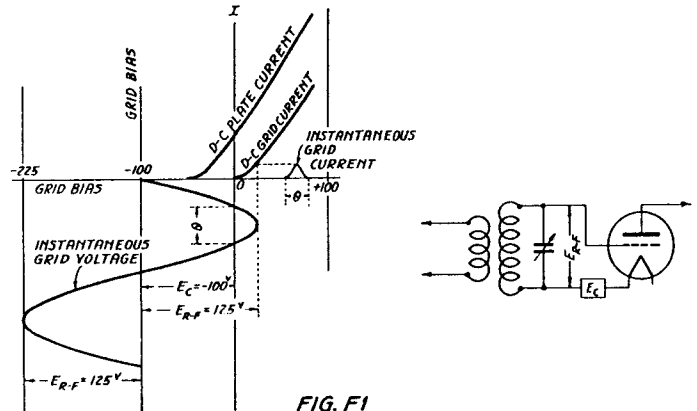

FIG. F1

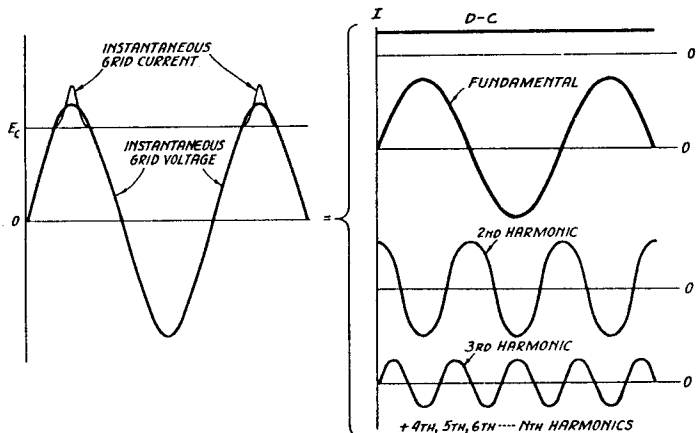

FIG. F2

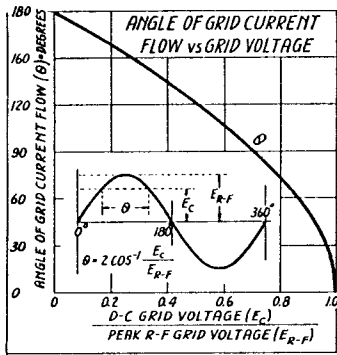

FIG. F3

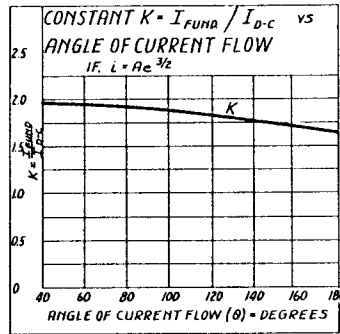

FIG. F4

grid voltage and the bias voltage. Then referring to Fig. F4 or Fig F5, the ratio of the fundamental component to the d-c component can be determined and the fundamental component calculated. Having the fundamental current, a simple electrical law can be used, which says that only current and voltage of the same frequency can produce any average power. The harmonics, therefore, may be neglected and the average driving power is:

$$\text{Av. Driving Power} = (\text{RMS Fund. R-F Grid Volt.}) (\text{RMS Fund. R-F Grid Current}^*) \quad (\text{FI})$$

*Resistive component, i.e., the component in phase with the r-f voltage.

In terms of the peak voltage and peak current, which are usually known, the power is:

$$\text{Av. Driving Power} = \frac{(\text{Peak Fund. R-F Grid Volt.}) (\text{Peak Fund. R-F Grid Current})}{2} \quad (\text{FII})$$

Since the peak fundamental grid current may be found in terms of the d-c grid current:

$$\text{Av. Driving Power} = \frac{(\text{Peak Fund. R-F Grid Voltage}) (\text{D-C Grid Current}) K}{2} \quad (\text{FIII})$$

where,

$$K = \frac{\text{Fundamental R-F Grid Current}}{\text{D-C Grid Current}}$$

It will be noticed from Fig. F5 that the constant, K, does not vary rapidly with the angle of flow and, for the usual angles of grid current flow in a transmitter, K is about 1.8, or K/2 is equal to 0.9. For all practical purposes then the grid driving power is:

$$\text{Av. Driving Power} = (\text{Peak R-F Grid Volt.}) (\text{D-C Grid Current}) 0.9 \quad (\text{FIV})$$

EFFECT OF GRID CURRENT CURVE

Furthermore, although the grid has been assumed to operate over a 3/2 power law, if the operation is actually over a linear or a square law curve, the results are not materially changed. The maximum error occurs for operating angles in the vicinity of 100°. At this point the driving power for the square law case is about 3% greater than that for the assumed 3/2 power case. For the linear case it is about 4% less.

BATTERY AS COMPARED TO RESISTOR BIAS

The grid driving power calculated on this basis is the total power input to the grid circuit of the tube. This power is divided between that actually lost in the grid of the tube and that used up in the bias device. It makes no difference whether the bias is supplied from a battery or an equivalent resistor. The power in one case is used in charging the bias battery and in the other case in the I²R loss of the resistor.

GRID CHARGING CURRENT In addition to the in-phase component of current that drives the grid, there is a charging current flowing through the grid to ground capacity of the tube. This component is 90° out of phase with the driving voltage and at frequencies lower than 14 megacycles it usually represents negligible r-f power. Above 14 megacycles, however, this current becomes very large and since the r-f resistance of the grid leads rises rapidly with frequency, the charging current flowing through the lead resistance results in a power loss that must also be supplied by the exciter. The magnitude of this power loss is not easily calculable as it is a function of factors that are not readily obtainable and that vary radically with different tube types. At 56 megacycles and higher frequencies this power may well be the determining factor in the driving power of a tube. This subject is discussed more fully under "Ultra High Frequency Operation".

| $\frac{E_c}{E_{r-f}}$ | θ DEGREES | $\frac{I_{fund}}{I_{d-c}} = K$ | $\frac{K}{2}$ |
|-----------------------|------------------|--------------------------------|---------------|
| 0 | 180 | 1.64 | 0.82 |
| 0.1 | 168 | 1.67 | 0.84 |
| 0.2 | 157 | 1.69 | 0.85 |
| 0.3 | 145 | 1.74 | 0.87 |
| 0.4 | 133 | 1.78 | 0.89 |
| 0.5 | 120 | 1.82 | 0.91 |
| 0.6 | 106 | 1.83 | 0.92 |
| 0.7 | 91 | 1.85 | 0.93 |
| 0.8 | 73 | 1.92 | 0.96 |
| 0.9 | 51 | 1.94 | 0.97 |
| 1.0 | 0 | 2.00 | 1.00 |

FIG. F5

MEASUREMENT OF PEAK R-F GRID VOLTAGE

The only factor not readily known is the peak r-f grid voltage. This can be found by the use of a simple diode voltmeter, the circuit of which is shown in Fig. F6. In operation the voltmeter is connected between the grid and filament of the transmitting tube and the d-c voltage adjusted by means of potentiometer, P, until the meter, M, just starts to read. The d-c voltmeter, V, then records the peak value of the r-f grid voltage. For extreme accuracy M should be a sensitive microammeter. Actually a 0-1 milliammeter or a 1000 ohms/volt, low range voltmeter is satisfactory. The values of E, P and V depend on the magnitude of the peak voltages to be measured.

PEAK VOLTMETER CIRCUIT

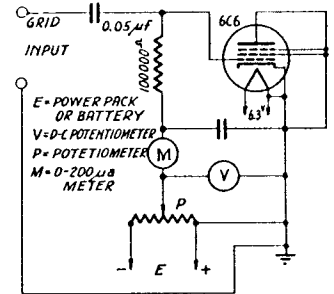

FIG. F6

CALCULATION OF DRIVING POWER The power input for the RK-30 and RK-37 will now be calculated as an example. From the data sheets or measurements:

| | RK-30 | RK-37 |
|---------------------------|--|-----------|
| Peak R-F Grid Voltage | 320 volts | 248 volts |
| D-C Grid Current | 18 ma | 22.4 ma |
| Av. Driving Power (RK-30) | $0.9 \times 320 \times 0.018 = 5.2$ watts | |
| Av. Driving Power (RK-37) | $0.9 \times 248 \times 0.0224 = 5.0$ watts | |

GRID IMPEDANCE The second factor that must be considered is the grid impedance. Over most of the cycle the grid impedance is infinite since the grid draws no current, but over the part of the cycle that current flows the impedance is relatively low. The grid impedance that will be expressed is an average impedance and represents the impedance the grid would have if its impedance were constant over the whole cycle and consumed the same average power as the varying impedance.

The average impedance can be calculated since the average input power and voltage are known.

$$\text{Av. Driving Power} = \frac{(\text{RMS Fund. Grid Voltage})^2}{\text{Average Grid Impedance}} \quad (\text{FV})$$

and the

$$\text{Av. Grid Impedance} = \frac{(\text{RMS Fund. Grid Voltage})^2}{\text{Av. Driving Power}} \quad (\text{FVI})$$

or, in terms of the peak r-f grid voltage:

$$\text{Av. Grid Impedance} = \frac{0.5 (\text{Peak R-F Grid Voltage})^2}{\text{Av. Driving Power}} \quad (\text{FVII})$$

Assuming the constant used to evaluate the input power is 0.9, an approximate expression for the grid impedance is:

$$\text{Grid Impedance} = \frac{0.56 (\text{Peak R-F Grid Voltage})}{\text{D-C Grid Current}} \quad (\text{FVIII})$$

The average grid impedance of the RK-30 and RK-37 is:

$$\text{RK-30: } \frac{0.56 \times 320}{0.018} = 10000 \text{ ohms}$$

$$\text{RK-37: } \frac{0.56 \times 248}{0.0224} = 6200 \text{ ohms}$$

RAYTHEON AMATEUR TUBES DRIVING POWER & APPROXIMATE GRID IMPEDANCE CLASS C—TELEGRAPHY

| Type | D-C Grid Milliamperes | Peak R-F Grid Volts | D-C Grid Volts | Driving Watts | Approx. Grid Imp.—Ohms |
|--------|-----------------------|---------------------|----------------|---------------|------------------------|
| RK-10 | 15 | 235 | -100 | 3.2 | 9000 |
| RK-11 | 21 | 170 | -120 | 3.2 | 4500 |
| RK-12 | 33 | 65 | 0 | 1.9 | 1000 |
| RK-18 | 12 | 255 | -160 | 2.8 | 12000 |
| RK-20A | 11.5 | 155 | -100 | 1.6 | 7500 |
| RK-23 | 4 | 135 | -90 | 0.5 | 19000 |
| RK-28 | 13 | 170 | -100 | 2.0 | 7500 |
| RK-30 | 18 | 320 | -180 | 5.2 | 10000 |
| RK-31 | 38 | 70 | 0 | 2.2 | 1000 |
| RK-32 | 14 | 380 | -225 | 4.8 | 15000 |
| RK-34 | 10 | 70 | -36 | 0.6 | 4000 |
| RK-35 | 15 | 375 | -250 | 5.0 | 14000 |
| RK-36 | 30 | 560 | -360 | 15 | 10000 |
| RK-37 | 30 | 260 | -130 | 7 | 5000 |
| RK-38 | 30 | 375 | -200 | 10 | 7000 |
| RK-39 | 3 | 117 | -90 | 0.3 | 22000 |
| RK-47 | 7 | 160 | -70 | 1.0 | 13000 |
| RK-48 | 6.5 | 170 | -100 | 1.0 | 15000 |
| RK-49 | 3 | 80 | -50 | 0.2 | 15000 |
| RK-51 | 31 | 365 | -250 | 10 | 6500 |
| RK-52 | 50 | 90 | 0 | 4 | 1000 |

FIG. F7

MATCHING THE AMPLIFIER GRID TO THE EXCITER PLATE

Returning to the RK-30 vs. RK-37 problem, as first stated, the exciter that was capable of supplying 5 watts to the 10,000 ohm load of the RK-30 could not supply 5 watts to the RK-37 grid which represented an average load of only 6200 ohms and the RK-37 was accordingly under excited. To drive the RK-37, it is necessary in this case to tap downward on the exciter tank. The point to tap the tank is the point where the load of the RK-37 grid will reflect into the plate circuit of the driver tube the optimum load for the driver. If the RK-37 grid is tapped directly onto the end of the tank coil of the driver, the driver plate load will be 6200 ohms, if the grid of the RK-37 is tapped halfway down on the tank coil and the coefficient of coupling between the coil sections above and below the tap is unity, the load reflected into the plate will be $4 \times 6200 = 24800$ ohms. The point of tapping can be calculated but it is much easier to obtain

it by experiment. The idea is to have the exciter always working into its optimum load; in other words, matching its output impedance to the input impedance of the amplifier.

LOW MU VS. HIGH MU TUBES In an accompanying table, Fig. F7, is listed the grid driving power and grid impedance of Raytheon Amateur tubes. It will be noticed that the higher mu tubes like the RK-37 and RK-38 have lower grid impedances than the low mu tubes. If the high mu tube is set at the minimum bias to give reasonable plate efficiency and the low mu tube is set at double cutoff, the driving power required by the high mu tube is considerably less than that required by the low mu tube. However, the bias on the low mu tube can usually be reduced to values that permit power gains as great as those realized with the high mu tube without serious reduction in plate efficiency. This applies to the tube itself. When the driver is also considered the grid impedance of the high mu tube more nearly matches the output impedance of the driver and the high mu tube appears to drive easier than the low mu tube.

Pentodes and tetrodes, of course, require little driving power and give greater power gain than other types. This is due to their low bias and grid current requirements.

HIGH EFFICIENCY—HIGH BIAS OPERATION It should be borne in mind that the table of grid impedances and grid driving powers applies only to tubes operating under the specified grid voltage and current conditions. For instance, if the grid bias voltage and grid excitation voltage are increased and the grid current kept constant as it is in high efficiency ("California Kilowatt") operation, the grid impedance and grid driving power both increase markedly. For example, an RK-38 operated in this manner shows the following values:

| D-C Grid Volts | D-C Grid Ma. | Peak R-F Volts | Av. Driving Power | Av. Grid Ohms |
|----------------|--------------|----------------|-------------------|---------------|
| -200 | 30 | 330 | 9 | 6000 |
| -400 | 30 | 530 | 15.1 | 10300 |
| -600 | 30 | 740 | 21.3 | 14500 |

The grid impedance of low mu tubes like the RK-35 and RK-36 which is already high at double cutoff, the usual operating point, will rise to extremely high values under high bias operation.

ZERO BIAS OPERATION Tubes designed for zero bias Class B operation, such as the RK-12, RK-52 and RK-31, can be successfully operated at somewhat reduced plate efficiency as r-f power amplifiers at zero bias for telegraphy. Since no bias device is required the driving power is only that necessary to supply the losses in the control grid. Since these are usually quite small, tubes operated in this fashion give excellent power gains. The grids of tubes operated at zero bias present a very low impedance load to the driver and, if the power gain of such tubes is to be taken advantage of, some method must be used to match the grid of these tubes to the driver, especially if the driver requires a high impedance load.

CAPACITY COUPLING If the data on output impedance in Fig. G7 is examined, it will be seen that in most cases it is impossible to get an exact impedance match between the input of the amplifier and the output of the driver by coupling the grid of the exciter and the plate of the driver directly together as is done with the usual capacity coupling. However, if the excitation is more than adequate and considerable power can be lost due to impedance mismatch, capacity coupling, Fig. F8A can be used. It is cheap, easily put together, requires little space, and will actually deliver more power to the output grid if the impedance match is almost right than other forms using an impedance matching network. If the impedance of the grid is lower than the driver impedance the grid can be tapped down on the amplifier coil. Quite often, however, this method results in the generation of parasitics.

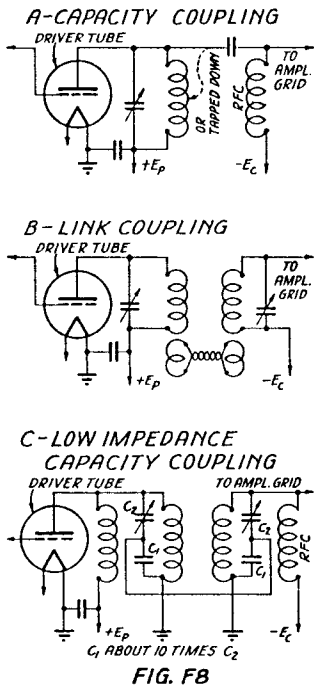

LINK COUPLING Link coupling, Fig. F8B, on the other hand has the ability, due to high leakage reactances to more nearly match input and output impedances. Power is lost in the second tuned circuit and link coupling can never be as efficient as capacity coupling if the grid impedance of the amplifier is equal to the output impedance of the driver. However, if the output impedance of the driver is radically different from the grid impedance of the amplifier, link coupling should be used and will effect a larger power transfer than capacity coupling, even though there are losses in the coupling circuits. It is most essential when the grid driving power is large and the grid impedance is high such as encountered in the before mentioned high bias operation. Link coupling, of course, possesses the advantage that the driver and the exciter can be at a considerable distance from each other without materially affecting the results. The impedance match can be improved by varying the relative number of turns on the end of the link or by changing the L/C ratio of the tuned circuit in the grid. If the driver tube is to work into a high impedance fewer turns should be used on the grid end of the link than on the plate end, conversely if the driver is to work into a low impedance more turns should be used on the grid end of the link. If matching is into a high impedance grid, a low C grid tank can be used but if the matching is into a low impedance grid, a high C tank is required. Besides the usual magnetic coupling, low impedance capacity coupling, Fig. 8C can be used.

PARALLELED AND PUSH-PULL OUTPUT STAGES In a paralleled output stage the driving voltage is the same and the grid current is double that of a single tube so that the grid impedance is one-half that for a single tube and the driving power is doubled. For push-pull tubes the grid to grid voltage required is doubled and the power is doubled so that the grid to grid impedance also doubles.

OUTPUT IMPEDANCE AND L/C RATIO

The output tank circuit of a transmitter may be considered as a circuit that is maintained in oscillation by pulses of energy supplied to it at its own natural frequency by the d-c power supply. The energy pulses are supplied through the medium of the output tube which acts as a sort of timing relay. Energy taken from the power supply must first be stored in the tank circuit before it can be delivered to the antenna in the form of useful power. The performance of a given transmitter, therefore, is tied irrevocably to the performance of the tank and a well designed tank circuit will play an important part in obtaining maximum effectiveness from the power that is available.

CIRCUIT COMPONENTS A tank circuit is made up of capacitance, inductance and resistance. The resonant frequency of this combination is given by:

$$f = \frac{1}{2\pi\sqrt{LC}} \quad (GI)$$

f = frequency—cycles per sec.
L = inductance—henries
C = capacitance—farads

Thus, for any value of inductance there is a value of capacitance that theoretically will tune the circuit to resonance. The resistance that is present in such a circuit arises from two sources. First, the resistance of the circuit and the associated wiring and second, the resistance transferred into the circuit by antenna loading. The inherent resistance of the circuit is desired as small as possible, since the power lost in heating the tank circuit is not available for radiation. The transferred resistance constitutes the useful loading of the tank.

EFFECT OF L/C RATIO ON TANK IMPEDANCE An unloaded tank circuit, shown in Fig. G1A will be considered in an effort to deduce methods by which the effective resistance of the tank can be reduced. It would seem first of all that it should be desirable to make the resistance as small as possible. This would be true for a fixed L/C ratio. However, the L/C ratio can be varied to advantage. The impedance of a resonant circuit with a certain series resistance, R_s, can be shown to be equivalent to a perfect resonant circuit with zero resistance, paralleled by an impedance, as shown in Fig. G1B, which is resistive and is equal to:

$$Z = \frac{(2\pi fL)^2}{R_s} \quad (GII)$$

This impedance is the tube load presented by the unloaded tank circuit and for minimum tank loss should be made as high as possible. By inspection it may be seen that Z increases directly as the inductance squared and inversely as the series resistance of the tuned circuit. If it is assumed that most of the circuit resistance is contained in the coil, the impedance of the tuned circuit will be improved by increasing the inductance since in almost every case the inductance squared will increase faster than the series resistance. The condenser used with the original coil must, of course, be reduced in value to restore the combination to resonance at the original frequency. On this basis the L/C ratio should be made as large as possible.

VARIATION OF TANK IMPEDANCE WITH FREQUENCY

The minimum plate current of a Class C stage is an excellent indication of the unloaded impedance of the output circuit. The minimum plate current increases with frequency and one is often led to believe that the tube is operating less efficiently at the higher frequencies. The fault lies almost invariably in the design of the tank circuit, usually because too small an inductance is being used and because of increasing resistance losses in the tank circuit. At 1.75 megacycles, for instance, the parallel impedance of an unloaded tank may be as high as 100,000 ohms but the impedance drops rapidly with frequency, until at 56 megacycles, the unloaded tank impedance is often almost the entire load on the tube. Practically all the power is consumed in the tank circuit and little power is available for the antenna and the minimum plate current is high. If an impedance of 100,000 ohms were available at this frequency, the minimum plate current would be the same as the minimum at 1.75 megacycles, assuming no other losses such as might be introduced by electron transit time in the tube. Tuned circuits of the "Derby Hat" variety will give high impedances and correspondingly low minimum plate currents at the ultra-high frequencies.

UNLOADED TANK CIRCUIT AND EQUIVALENT CIRCUIT

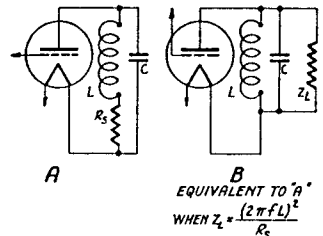

FIG. G1

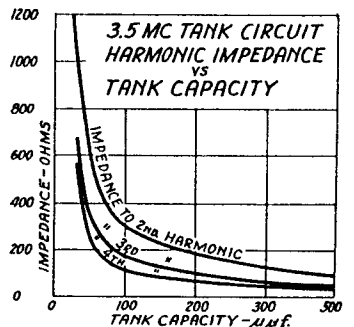

FIG. G2

HARMONIC RADIATION On the basis of the foregoing, it would seem that the desirable tank circuit is one in which the tuning the absolute minimum. However, too low a tank capacitance will result in circuit instability and increased harmonic radiation. Fig. G2 shows the impedance presented by a 3.5 megacycle tank circuit to harmonics as the capacitance is changed. A high capacitance is obviously desirable for low harmonic impedance so that a compromise must be effected between this and the low capacitance needed for a high efficiency tank.

QUALITY FACTOR OR Q OF TANK CIRCUIT The ratio of the harmonic voltage to the fundamental voltage across a tank can be shown to be a function of the Q of the tank circuit if the ratio of the fundamental component of plate current to the harmonic component is fixed. Q is a measure of the quality of an inductive, capacitive, or tuned circuit and is expressed as the ratio of the inductive or capacitive reactance to the resistance. For an inductance:

$$Q = \frac{2\pi fL}{R_L} \quad (GIII)$$

For a capacitance:

$$Q = \frac{1}{2\pi fC R_C} \quad (GIV)$$

For a tuned circuit:

$$Q = \frac{2\pi fL}{R_L + R_c} = \frac{1}{2\pi fC(R_L + R_c)} \quad (GV)$$

In a tuned circuit for frequencies lower than 7 megacycles the r-f resistance of the condenser is usually quite small as compared to the resistance of the coil so that the Q is practically determined by the resistance of the coil.

$$Q = \frac{2\pi fL}{R_L} = \frac{1}{2\pi fC R_L} \quad (GVI)$$

However, for higher frequencies the r-f resistance of the condenser may become the determining factor.

Q OF A LOADED TANK The Q of the tank circuit is highest when unloaded. Loading the tank by transferring a resistance from the antenna lowers the Q. For instance, the Q of a 3.5 megacycle tank circuit may be 80 when unloaded but will fall to 10 or 15 when loaded. A value of Q for the loaded tank circuit that is a compromise between circuit efficiency and harmonic output is about 12. This value is the Q of the tank circuit itself. If the tube circuit as a whole is considered the output impedance of the tube shunts the tank circuit and, if it is further assumed that the load impedance matches the tube plate impedance, the Q of the entire circuit, for a tank circuit Q of 12, is only 6. The Q of the tank circuit itself determines the efficiency of the tank. The Q of the tank circuit shunted by the output impedance of the tube determines the harmonic radiation.

CALCULATION OF CAPACITANCE FOR GIVEN TANK CIRCUIT Q The capacitance necessary to give a tank circuit Q of 12 can be easily calculated.

$$Z_L = \frac{(2\pi fL)^2}{R} = 2\pi fL Q \quad (GVII)$$

Since at resonance:

$$Z_L = \frac{1}{2\pi fC} \quad (GVIII)$$

- Z_L = Equivalent Load Resistance—ohms
- R = Circuit Resistance—ohms
- f = Frequency—cycles/sec
- L = Inductance—henries
- C = Capacitance—farads

$$Z_L = \frac{1}{2\pi fC} \quad (GIX)$$

and

$$C = \frac{Q}{2\pi f Z_L} \quad (GX)$$

If Q is assumed to be 12 and the frequency of operation is known and if Z_L can be found, the minimum permissible capacitance can be calculated. The power developed across Z_L is the power output of the tube.

where:
 e_p = Peak a-c voltage across Z_L, volts $P_o = \frac{e_p i_p}{2}$ (GXII)

i_p = Peak a-c current through Z_L, amperes $P_i = E_p I_p$ (GXIII)

The power input is:
 where:
 E_p = D-C plate voltage—volts
 I_p = D-C plate current—amperes

The plate efficiency is: $n = \frac{P_o}{P_i} = \frac{0.5 e_p i_p}{E_p I_p}$ (GXIV)

The peak a-c plate voltage is: $e_p = \frac{2n E_p I_p}{i_p} = 2n E_p \frac{1}{K}$ (GXV)

where: $K = \frac{i_p}{I_p}$

Since the efficiency of the usual output stage is about 70% and the ratio of the d-c plate current to the fundamental component for various angles of plate current flow can be found from the curve in Fig. F4 the voltage e_p can be calculated.

The power output is: $P_o = I_p E_p n$ (GXVI)

This power is developed across Z_L: $P_o = \frac{(0.707 e_p)^2}{Z_L}$ (GXVII)

$P_o = \frac{(e_p)^2}{2 Z_L}$ (GXVIII)

and $Z_L = \frac{(e_p)^2}{2 P_o}$ (GXIX)

$Z_L = \frac{(e_p)^2}{2 I_p E_p n}$ (GXX)

Substituting (GXIV) in (GXIX) and the result in (GX):
 $C = \frac{Q(K^2)}{4\pi f n} \frac{I_p}{E_p} = \frac{Q(K^2)}{4\pi f n R_B}$ (GXXI)

where $R_B = \text{apparent d-c resistance of the output stage as presented to the power supply}$ $= \frac{E_p}{I_p}$ and $\frac{1}{R_B} = \frac{I_p}{E_p}$

For an average operating angle of 120°: K = 1.82

For:
 $Q = 12$
 $K = 1.82$
 $n = 70\%$
 $f = \text{frequency in megacycles}$
 $C = \frac{4520000}{f R_B}$ (GXXII)

EFFECT OF OUTPUT CIRCUIT ON TANK CAPACITANCE Using formula (GXXI) a chart of tank capacitances for the various frequency bands for varying input resistances is given in Fig. G3. These capacitance values have been developed on the basis of a single ended amplifier where the entire output tank is included between the plate and cathode of the output tube. For amplifiers where this condition does not exist the value of capacitance must be modified. For a fixed Q, the capacitance will vary inversely as the load impedance. Thus, referring to Fig. G3 and assuming that the tube is loaded to the same d-c plate current at the same d-c plate voltage in each single ended circuit and that two similar tubes are used in the push-pull circuit and that the two tubes are loaded to twice the current of the single ended circuit, the capacitance value in each case can be determined with reference to the single ended case where the entire tank circuit is included between the plate and cathode. For a grid neutralized amplifier and for a plate neutralized amplifier with an untapped tank, the capacitance required is the same as for the reference circuit.

TANK CAPACITANCE—μf

| R _B = $\frac{E_p}{I_p}$ OHMS | TANK CIRCUIT Q=12 | | | | | | | | | EFFICIENCY=70% | | | | | | | | |
|--|-------------------|-----|-----|--------------|-----|-----|--------------|-----|----|----------------|----|----|-------------|----|----|-------------|----|----|
| | 1.75 MC. BAND | | | 3.5 MC. BAND | | | 7.0 MC. BAND | | | 14 MC. BAND | | | 28 MC. BAND | | | 56 MC. BAND | | |
| | A | B | C | A | B | C | A | B | C | A | B | C | A | B | C | A | B | C |
| 2000 | 1291 | 646 | 323 | 646 | 323 | 162 | 323 | 162 | 81 | 162 | 81 | 41 | 81 | 41 | 21 | 41 | 21 | 11 |
| 4000 | 646 | 323 | 162 | 323 | 162 | 81 | 162 | 81 | 41 | 81 | 41 | 21 | 41 | 21 | 11 | 21 | 11 | 6 |
| 6000 | 431 | 216 | 108 | 216 | 108 | 54 | 108 | 54 | 27 | 54 | 27 | 14 | 27 | 14 | 7 | 14 | 7 | 4 |
| 8000 | 323 | 162 | 81 | 162 | 81 | 41 | 81 | 41 | 21 | 41 | 21 | 11 | 21 | 11 | 6 | 11 | 6 | 3 |
| 10000 | 268 | 134 | 67 | 134 | 67 | 34 | 67 | 34 | 17 | 34 | 17 | 9 | 17 | 9 | 5 | 9 | 5 | 3 |
| 12000 | 216 | 108 | 54 | 108 | 54 | 27 | 54 | 27 | 14 | 27 | 14 | 7 | 14 | 7 | 4 | 7 | 4 | 2 |
| 14000 | 185 | 93 | 47 | 93 | 47 | 24 | 47 | 24 | 12 | 24 | 12 | 6 | 12 | 6 | 3 | 6 | 3 | 2 |
| 16000 | 162 | 81 | 41 | 81 | 41 | 21 | 41 | 21 | 11 | 21 | 11 | 6 | 11 | 6 | 3 | 6 | 3 | 2 |
| 18000 | 143 | 72 | 36 | 72 | 36 | 18 | 36 | 18 | 9 | 18 | 9 | 5 | 9 | 5 | 3 | 5 | 3 | 2 |

- USE COLUMN "A" FOR:
- SINGLE TUBE—NOT NEUTRALIZED—CIRCUIT 1
 - SINGLE TUBE—GRID NEUTRALIZED—CIRCUIT 2
 - SINGLE TUBE—PLATE NEUTRALIZED—CIRCUIT 3
- USE COLUMN "B" FOR:
- SINGLE TUBE—PLATE NEUTRALIZED, TAP 1/3 FROM LOW END—CIRCUIT 5
 - SINGLE TUBE—PLATE NEUTRALIZED—SPLIT STATOR CONDENSER, PER SECTION—CIRCUIT 4
 - PUSH-PULL—SPLIT STATOR CONDENSER, PER SECTION—CIRCUIT 6
- USE COLUMN "C" FOR:
- PUSH-PULL—CONDENSER NOT SPLIT
 - SINGLE TUBE—PLATE NEUTRALIZED—CENTER-TAPPED TANK COIL—CIRCUIT 5

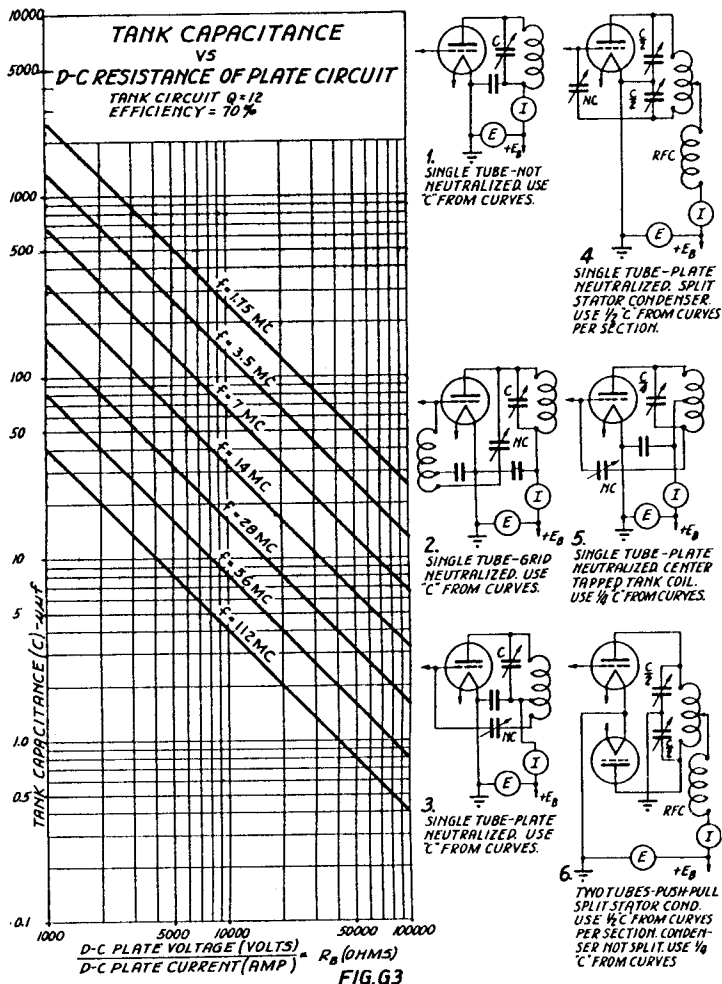

FIG. G3
 For push-pull output, whether the tank is split or not, the load impedance is two times as great so that the total capacitance must be reduced to 1/2 the reference value. The capacitance per section is therefore the same as the total capacitance for a single ended grid neutralized stage of the same input power. However, the push-pull stage will have twice the power input and half the R_B of the single ended stage and if the capacitance is calculated using the R_B of the push-pull stage, the result must be again divided by 2.
 For a single-ended plate neutralized amplifier, with a center-tapped tank coil, the load is quadrupled, therefore the total capacitance is 1/4 and the capacitance per section is 1/2 the total capacitance for the reference case. If

INSULATED COPPER WIRE TABLE

| Size B&S Gage | ENAMEL WIRE | | | SINGLE—SILK COVERED | | | DOUBLE—SILK COVERED | | |
|---------------------|--------------------------|----------------------------|---------------------------|--------------------------|----------------------------|---------------------------|--------------------------|----------------------------|---------------------------|
| | Outside Dia. mils. | Turns per linear in. | Pounds per 1000 ft. | Outside Dia. mils. | Turns per linear in. | Pounds per 1000 ft. | Outside Dia. mils. | Turns per linear in. | Pounds per 1000 ft. |
| 8 | 130.6 | 7.7 | 50.6 | | | | | | |
| 9 | 116.5 | 8.6 | 40.2 | | | | | | |
| 10 | 104.0 | 9.6 | 31.8 | | | | | | |
| 11 | 92.7 | 10.8 | 25.3 | | | | | | |
| 12 | 82.8 | 12.1 | 20.1 | | | | | | |
| 13 | 74.0 | 13.5 | 15.90 | | | | | | |
| 14 | 66.1 | 15.1 | 12.60 | | | | | | |
| 15 | 59.1 | 16.9 | 10.00 | | | | | | |
| 16 | 52.8 | 18.9 | 7.930 | 52.8 | 18.9 | 7.89 | 54.6 | 18.3 | 8.00 |
| 17 | 47.0 | 21.3 | 6.275 | 47.3 | 21.1 | 6.26 | 49.1 | 20.4 | 6.32 |
| 18 | 42.1 | 23.8 | 4.980 | 42.4 | 23.6 | 4.97 | 44.1 | 22.7 | 5.02 |
| 19 | 37.7 | 26.5 | 3.955 | 37.9 | 26.4 | 3.94 | 39.7 | 25.2 | 3.99 |
| 20 | 33.7 | 29.7 | 3.135 | 34.0 | 29.4 | 3.13 | 35.8 | 28.0 | 3.17 |
| 22 | 26.9 | 37.2 | 1.970 | 27.3 | 36.6 | 1.98 | 29.1 | 34.4 | 2.01 |
| 24 | 21.5 | 46.5 | 1.245 | 22.1 | 45.3 | 1.25 | 23.9 | 41.8 | 1.27 |
| 26 | 17.1 | 58.5 | 0.785 | 17.9 | 55.9 | 0.791 | 19.7 | 50.8 | 0.810 |
| 28 | 13.6 | 73.5 | 0.494 | 14.6 | 68.5 | 0.498 | 16.4 | 61.0 | 0.514 |
| 30 | 10.9 | 91.7 | 0.311 | 12.0 | 83.3 | 0.316 | 13.8 | 72.5 | 0.333 |
| 32 | 8.7 | 115 | 0.196 | 9.9 | 101 | 0.210 | 11.8 | 84.8 | 0.217 |
| 34 | 6.9 | 145 | 0.123 | 8.3 | 121 | 0.129 | 10.1 | 99.0 | 0.141 |
| 36 | 5.5 | 180 | 0.078 | 7.0 | 143 | 0.082 | 8.8 | 114 | 0.092 |
| 38 | 4.4 | 227 | 0.049 | 6.0 | 167 | 0.053 | 7.8 | 128 | 0.062 |
| 40 | 3.5 | 286 | 0.031 | 5.1 | 196 | 0.035 | 6.9 | 145 | 0.043 |

FIG. G6

VALUE OF K IN FORMULA (GXXII)

| Diameter to Length | K | Diameter to Length | K | Diameter to Length | K |
|--------------------------|--------|--------------------------|--------|--------------------------|--------|
| 0.00 | 1.0000 | 2.00 | 0.5255 | 7.00 | 0.2584 |
| .05 | .9791 | 2.10 | .5137 | 7.20 | .2637 |
| .10 | .9588 | 2.20 | .5025 | 7.40 | .2491 |
| .15 | .9391 | 2.30 | .4918 | 7.60 | .2448 |
| .20 | .9201 | 2.40 | .4816 | 7.80 | .2406 |
| 0.25 | 0.9016 | 2.50 | 0.4719 | 8.00 | 0.2366 |
| .30 | .8838 | 2.60 | .4626 | 8.50 | .2272 |
| .35 | .8665 | 2.70 | .4537 | 9.00 | .2185 |
| .40 | .8499 | 2.80 | .4452 | 9.50 | .2106 |
| .45 | .8337 | 2.90 | .4370 | 10.00 | .2033 |
| 0.50 | 0.8181 | 3.00 | 0.4292 | 10.0 | 0.2033 |
| .55 | .8031 | 3.10 | .4217 | 11.0 | .1903 |
| .60 | .7885 | 3.20 | .4145 | 12.0 | .1790 |
| .65 | .7745 | 3.30 | .4075 | 13.0 | .1692 |
| .70 | .7609 | 3.40 | .4008 | 14.0 | .1605 |
| 0.75 | 0.7478 | 3.50 | 0.3944 | 15.0 | 0.1527 |
| .80 | .7351 | 3.60 | .3882 | 16.0 | .1457 |
| .85 | .7228 | 3.70 | .3822 | 17.0 | .1394 |
| .90 | .7110 | 3.80 | .3764 | 18.0 | .1336 |
| .95 | .6995 | 3.90 | .3708 | 19.0 | .1284 |
| 1.00 | 0.6884 | 4.00 | 0.3654 | 20.0 | 0.1236 |
| 1.05 | .6777 | 4.10 | .3602 | 22.0 | .1151 |
| 1.10 | .6673 | 4.20 | .3551 | 24.0 | .1078 |
| 1.15 | .6573 | 4.30 | .3502 | 26.0 | .1015 |
| 1.20 | .6475 | 4.40 | .3455 | 28.0 | .0959 |
| 1.25 | 0.6381 | 4.50 | 0.3409 | 30.0 | 0.0910 |
| 1.30 | .6290 | 4.60 | .3364 | 35.0 | .0808 |
| 1.35 | .6201 | 4.70 | .3321 | 40.0 | .0728 |
| 1.40 | .6115 | 4.80 | .3279 | 45.0 | .0664 |
| 1.45 | .6031 | 4.90 | .3238 | 50.0 | .0611 |
| 1.50 | 0.5950 | 5.00 | 0.3198 | 60.0 | 0.0528 |
| 1.55 | .5871 | 5.20 | .3122 | 70.0 | .0467 |
| 1.60 | .5795 | 5.40 | .3050 | 80.0 | .0419 |
| 1.65 | .5721 | 5.60 | .2981 | 90.0 | .0381 |
| 1.70 | .5649 | 5.80 | .2916 | 100.0 | .0350 |
| 1.75 | 0.5579 | 6.00 | 0.2854 | | |
| 1.80 | .5511 | 6.20 | .2795 | | |
| 1.85 | .5444 | 6.40 | .2739 | | |
| 1.90 | .5379 | 6.60 | .2685 | | |
| 1.95 | .5316 | 6.80 | .2633 | | |

FIG. G5

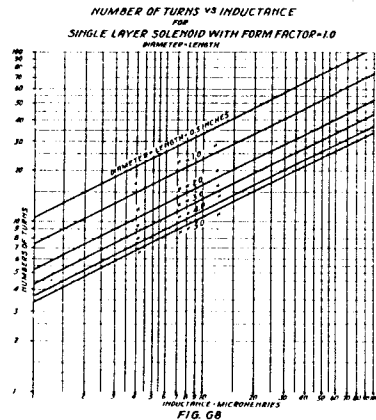

LOAD IMPEDANCE OF RAYTHEON AMATEUR TUBES
CLASS C—TELEGRAPHY

| Type | D-C Plate Volts = E _p | One Tube D-C Plate Ma. = I _p | R _B = E _p I _p | One Tube Load Imp. Ohms— P to K | Push-Pull Load Imp. Ohms— P to P |
|--------|-------------------------------------|---|--|--|---|
| RK-10 | 450 | 65 | 6930 | 2770 | 5540 |
| RK-11 | 750 | 105 | 7140 | 2850 | 5700 |
| RK-12 | 750 | 105 | 7140 | 2850 | 5700 |
| RK-18 | 1250 | 100 | 12500 | 5000 | 10000 |
| RK-20A | 1250 | 92 | 13600 | 5440 | 10900 |
| RK-23 | 500 | 50 | 10000 | 4000 | 8000 |
| RK-28 | 2000 | 150 | 13300 | 5300 | 10600 |
| RK-30 | 1250 | 90 | 13900 | 5550 | 11100 |
| RK-31 | 1250 | 100 | 12500 | 5000 | 10000 |
| RK-32 | 1250 | 100 | 12500 | 5000 | 10000 |
| RK-34 | 300 | 40 | 7500 | 3000 | 6000 |
| RK-35 | 1500 | 115 | 13000 | 5200 | 10400 |
| RK-36 | 2000 | 150 | 13300 | 5300 | 10600 |
| RK-37 | 1500 | 115 | 13000 | 5200 | 10400 |
| RK-38 | 2000 | 160 | 12500 | 5000 | 10000 |
| RK-39 | 600 | 93 | 6450 | 2580 | 5160 |
| RK-47 | 1250 | 138 | 9060 | 3620 | 7240 |
| RK-48 | 2000 | 180 | 11100 | 4440 | 8880 |
| RK-49 | 400 | 95 | 4200 | 1680 | 3360 |
| RK-51 | 1500 | 150 | 10000 | 4000 | 8000 |
| RK-52 | 1500 | 150 | 10000 | 4000 | 8000 |

FIG. G7

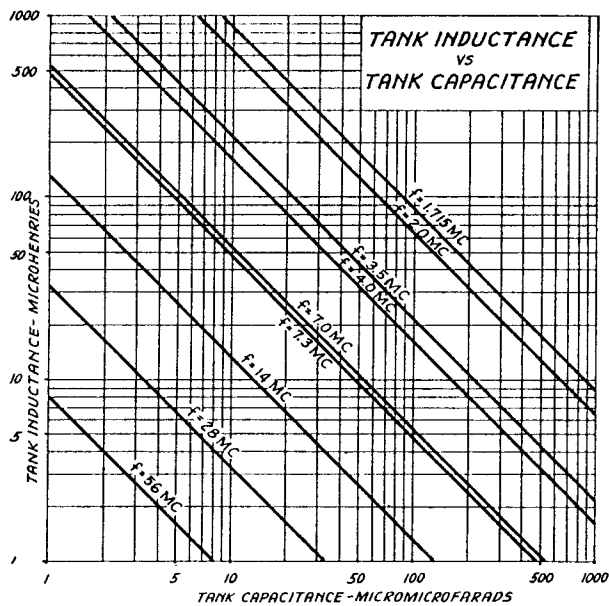

FIG. G4

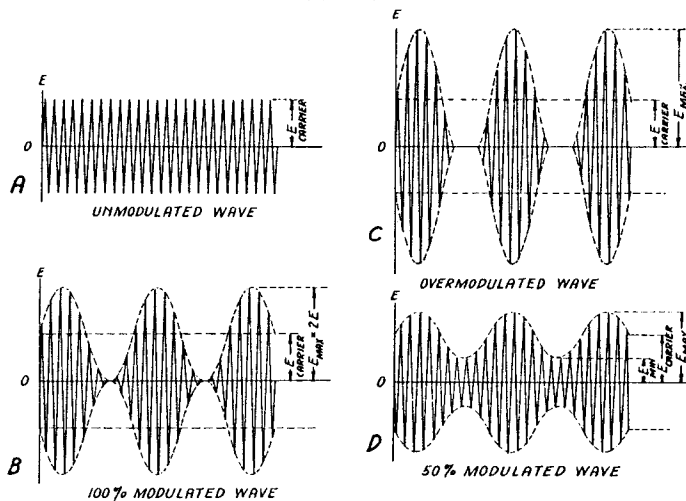

FIG. H1

a single tube is plate neutralized by splitting the tank coil, the load splits as the square of the turns ratio, assuming perfect coupling between the turns of the coil. A coil split in the center is equivalent to the split condenser case and the capacitance required is 1/4 that used for the reference circuit. A coil tapped up 1/3 from the low potential end and this is the usual tapping point, will require a total capacity of 4/9 the reference value.

Tubes in parallel act exactly as though they were a single tube drawing twice the plate current of one tube at the same plate voltage. The capacitance required is double that for a single tube. The capacitances tabulated are the absolute minimum that can be used. Somewhat larger values will reduce the tank circuit efficiency only slightly but will further reduce the harmonic radiation. For phone operation a somewhat larger capacity should be used. A self-excited oscillator requires the use of about three times as much capacitance as the reference circuit.

INDUCTANCE Having obtained the value of capacitance, the required value of inductance may be found from formula, G1, or from the curves in Fig. G4.

A design formula for single layer coils, which includes spacing effects is:

a = radius of coil—inches
 b = length of coil—inches
 n = number of turns

$$L = \frac{0.1003 a^2 n^2 K}{b} \quad (GXXII)$$

L = inductance—microhenries
 K = a constant depending on the ratio of diameter to length, 2a/b, see Fig. G5.

$$n = \frac{1}{a} \sqrt{\frac{bL}{0.1003 K}} \quad (GXXIII)$$

The Wire Table in Fig. G6 will be found useful in determining the proper wire size.

It has been found that a coil whose diameter equals its length gives least coil loss in the high frequency bands. The curves in Fig. G8 show the number of turns vs. the inductance in microhenries for single layer coils having the diameter equal to the length, and will be found useful in designing high frequency coils.

The coils should be wound of wire large enough to carry the r-f current without appreciable heating. Self-supporting coils are best although ceramic forms and certain composition forms operate very well. Some idea of the loss that is introduced by the form used may be obtained by comparing the minimum plate current of a Class C amplifier using coils of the same inductance but with different forms. Often, the loss present in the dielectric is such a small percentage of the loss in the coil itself that it is not economical to use a special ceramic form when an ordinary composition form might serve the purpose just as well.

LOAD IMPEDANCE A factor which is decidedly useful in the design of a transmitter is the load impedance of the tube. This value in general gives some idea of the matching network necessary to use between a driver stage, for instance, and the output tube. From equation (GXIX):

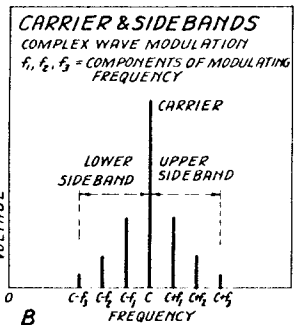
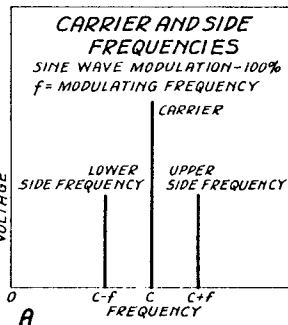

FIG. H2

$$Z_L = \frac{(e_p)^2}{2 I_p E_p n}$$

and from equation (GXIV):

$$e_p = \frac{1}{2n E_p} K$$

$$Z_L = \frac{2n}{K^2} \times \frac{E}{I_p} = \frac{2n}{K^2} \times R_B \quad (GXXIV)$$

For an efficiency of 70% and an operating angle of 120° as before:

$$Z_L = \frac{2 \times 0.7}{1.82} \times R_B = 0.42 R_B \quad (GXXV)$$

The load impedance is, therefore, a function of the d-c plate current and voltage assuming constant efficiency and operating angle.

The table in Fig. G7 shows the approximate load resistance for Raytheon Amateur tubes under Class C operating conditions. The load resistance may not be the optimum but it is approximately so. It will be noticed that the pentode types do not use a high load resistance. A popular notion seems to be that the plate load resistance of a pentode is very high. This is not true, although the optimum load resistance of a pentode is higher than that of a triode, the optimum load resistance is the same as for a triode drawing the same d-c plate current at the same d-c plate voltage.

MODULATION

MECHANICS To transmit intelligence by means of a radio frequency wave, the wave must first be modulated. Modulation usually consists of varying the amplitude of the wave so that the variations can be interpreted by the receiver. For CW transmission the amplitude of the wave is varied by stopping and starting the oscillations in an accepted manner (International Morse Code). For the transmission of voice the wave must be varied in accordance with the audible sounds to be transmitted.

Fig. H1A represents an unmodulated radio frequency wave of a peak value, E. The maximum possible reduction in the amplitude of this wave in a negative direction is to 0, therefore, the peak negative reduction in this wave is equal to E. If this value were exceeded the wave would be over-modulated and completely cutoff, as shown in Fig. H1C. In a positive direction the amplitude of the wave can be increased indefinitely. Since any complex wave can be resolved into an infinite number of pure sine wave components, it is customary to base modulation calculations on such waves. For this case the maximum

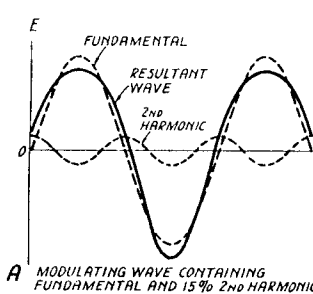

| MODULATING WAVE | FUNDAMENTAL POWER IN SIDE BANDS | ANTENNA CUR. INCREASE 100% MOD. |
|-----------------|--|---------------------------------|
| SINE WAVE | 50% OF CARRIER | 22.5% |
| AS SHOWN IN "B" | 36% OF CARRIER 76% OF SINE WAVE MODULATION | 16.8% |
| AS SHOWN IN "C" | 66% OF CARRIER 132% OF SINE WAVE MODULATION | 29.0% |

A MODULATING WAVE CONTAINING FUNDAMENTAL AND 15% 2ND HARMONIC

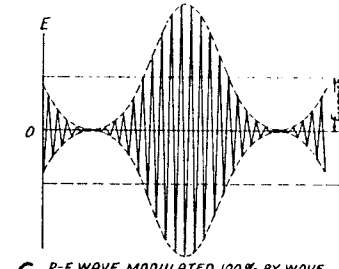
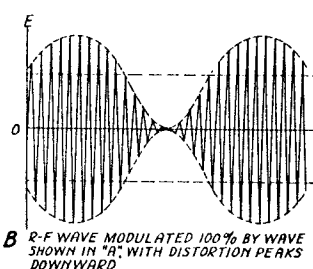

B R-F WAVE MODULATED 100% BY WAVE SHOWN IN "A", WITH DISTORTION PEAKS DOWNWARD

C R-F WAVE MODULATED 100% BY WAVE SHOWN IN "A", WITH DISTORTION PEAKS UPWARD

FIG. H-3

modulation occurs when the wave is modulated down to zero and up to a peak value of 2E, as shown in Fig. H1B. This is considered complete modulation and is termed 100% modulation or operation with a modulation factor of 1.0. Fig. H1D shows a wave that is not completely modulated.

The upward modulation is:

$$M_1 = \frac{E_{max} - E_{carrier}}{E_{carrier}} \quad (HI)$$

The downward modulation is:

$$M_2 = \frac{E_{carrier} - E_{min}}{E_{carrier}} \quad (HII)$$

If the wave is sinusoidal or symmetrical about the carrier value the upward and downward modulation factors are equal and in terms of the negative and positive modulation peaks the modulation factor is:

$$M = \frac{E_{max} - E_{min}}{E_{max} + E_{min}} \quad (HIII)$$

Since power is proportional to the square of the voltage, the peak power of a modulated wave is:

$$P_p = K(E_c)^2 (M^2 + 1) \quad (HIV)$$

E_c = Peak Carrier Voltage
 K = A Constant
 M = Modulation Factor

For a modulation factor of 1.0, the peak power is four times the carrier value.

The average power of a modulated wave is equal to:

$$Avg. Power = K(E_c)^2 \left(\frac{M^2}{2} + 1 \right) \quad (HV)$$

For a modulation factor of 1.0 the average power is 50% greater than the carrier power. Since the average output power is increased by 50%, the increase in output current or voltage at full modulation is equal to:

$$\sqrt{1.5} \times I_{carrier} = 1.225 \times I_{carrier} \quad (HVI)$$

$$\sqrt{1.5} \times E_{carrier} = 1.225 \times E_{carrier} \quad (HVII)$$

SIDE BANDS If the modulating wave is a pure sine wave, the modulation process can be shown to produce two additional frequencies spaced above and below the carrier frequency by amounts that are equal to the modulation frequency as shown in Fig. H2A. At 100% modulation, each of these frequencies possesses an average power that is equal to 25% of the carrier power. The magnitude of the average voltage in the side frequencies at 100% modulation is equal to 50% of the carrier voltage. If the modulating wave is a complex audio wave of many frequencies, such as is produced by speech or music, the side frequencies above and below the carrier frequency extend out to the highest audio frequency being transmitted, as shown in Fig. H2B and are known as side bands.

EFFECT OF PHASE OF 2ND HARMONIC ON MODULATION If the modulating voltage is distorted the results for antenna current increase and side band power calculated for a pure sine wave are not valid. A sharply peaked modulating wave form of proper phase, such as is produced by a strong second harmonic component, will reach a condition of 100% modulation before the maximum theoretical sideband power with a pure sine wave is reached. If such a wave is

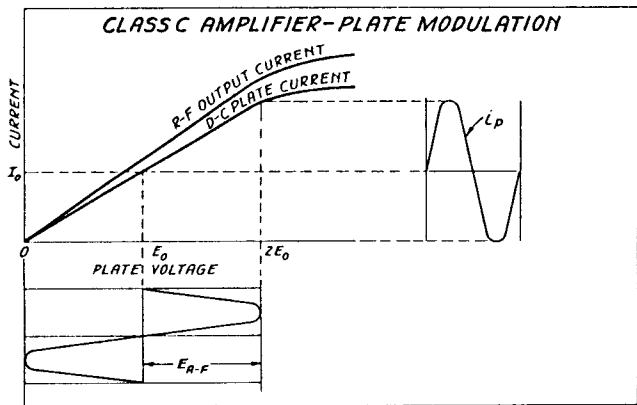

FIG. H4

reversed in phase, more power can be put into the side bands at 100% modulation than is possible with a sine wave. For the first case, the antenna current at 100% modulation will be less than $1.225 \times$ the carrier value; for the second case it will be greater.

Fig. H3A shows a modulating wave consisting of a fundamental and 15% second harmonic. In Fig. H3B this wave is shown modulating an r-f carrier, with the distortion peaks downward. In this case, when the downward modulation is 100% the upward modulation is less than 100% due to the unsymmetrical shape of the modulating wave. The fundamental power in the sidebands, at 100% modulation, is 36% of the carrier power as compared to 50% for a modulating wave of pure sine wave form and the fundamental sideband power is 76% of that with sine wave modulation. If the phase of the modulating wave is changed by 180° (modulation transformer reversed) the wave appears as shown in Fig. H3C. At 100% modulation the fundamental sideband power is 66% of the carrier power or 132% of that with sine wave modulation. The antenna current increase with 100% modulation for the condition, shown in Fig. H3B, is 16.8% and for the condition shown in Fig. H3C is 29% as compared to 22.5% for sine wave modulation.

For the transmission of a speech modulated wave, it is possible to show that the average side band power in a fully modulated wave is only about 50% of that with a pure tone because of the complex nature of speech. The antenna current increase therefore will be only about 12% and with the sluggishness of antenna ammeters, it is usual to expect only about a 5% increase in antenna current meter reading while modulating 100%.

MODULATION AT LESS THAN 100% The side bands carry the intelligence that is to be converted into audible frequencies by the receiver and the greater the power put into the side bands the greater the magnitude of the received signals. As the percentage modulation is reduced the power in the side bands is reduced. At 80% modulation, however, it is only down about 2 db from the 100% value. Although this decrease in signal strength is hardly noticeable, the saving in modulation power is considerable, the reduction being 36%. 100% modulation is a desirable

modulation percentage to maintain because it represents the maximum modulation capability of a transmitter. However, the reduced distortion and the freedom from the possibility of overmodulation at the lower modulation percentages sometimes outweigh the gain in signal strength that is obtained by the use of 100% modulation.

Equal side band power will produce the same audio output from a linear detector regardless of the carrier strength. For instance, a completely modulated 250 watt carrier is exactly equivalent to a 1000 watt carrier modulated only 50%. For a detector operating in the square law region, however, the one kilowatt signal would give a rectified audio voltage twice that for the 250 watt signal, which would represent a gain of about six db in the received signal. This to a certain extent justifies the use of a higher powered carrier modulated with the available audio power since many high frequency receivers use detectors that are operating, for weak signals at least, in the square law region. The interference created by the stronger carrier is greater and for this reason it is desirable to operate with a weaker carrier completely modulated.

HEISING MODULATION

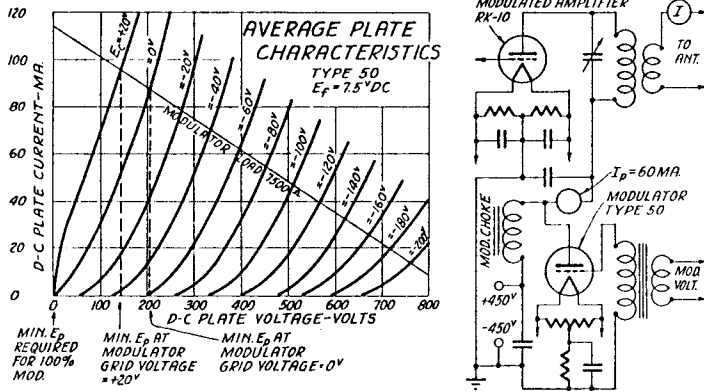

FIG. H5

Operation is, of course, not particularly economical with a strong carrier, i.e., the increase in power supplied to the transmitter is not justified by the increase in signalling effectiveness.

MODULATION METHODS To obtain modulation of the transmitted wave in the manner just described several systems are in general use. Modulation can be accomplished by any system which will vary the amplitude of the transmitted wave at an audio rate. Thus, if the plate voltage of a Class C amplifier is varied, it will be found that the output current will vary linearly over a wide range of plate voltage. Similarly, if the d-c grid voltage is varied, it will also be found that, under certain conditions of excitation and bias, linear variations in output are possible. In a pentode, variation of the screen or suppressor voltages will vary the output. Any of these schemes or combinations of them can be successfully used to obtain modulation. Each system, however, presents its own individual problems.

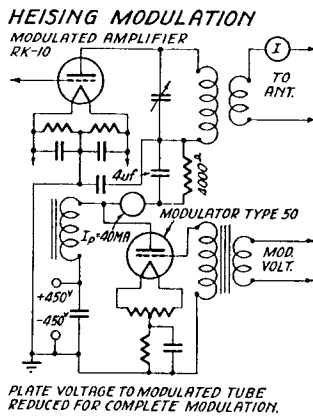

FIG. H6

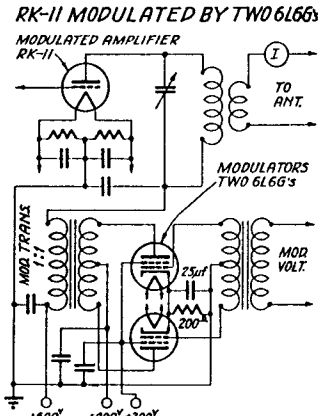

FIG. H7

PLATE MODULATION Plate modulation is probably the most linear of all the systems of modulation. While it requires considerably larger modulation equipment than other systems, it is usually quite simple to adjust. The modulated tube runs at good efficiency and there is little wasted power. The usual difficulty encountered with plate modulation is inability to hit the positive modulation peaks. This can usually be overcome either by increasing the excitation or decreasing the load impedance. If it is not possible to increase the positive peaks by these methods the carrier plate voltage must be reduced.

With practical tubes it is impossible to get perfectly linear modulation up to 100% when fixed bias is used. Automatic bias tends to overcorrect this effect so that a combination of fixed and automatic bias is best. Since the bias must change with modulation high initial biases (twice cut off or greater) should be used since the required bias change is most easily obtained when it is a small fraction of the total bias voltage.

If the plate voltage of a Class C amplifier is increased from zero it will be found that the output current will increase linearly with plate voltage up to a

certain point where it will begin to flatten off. This point represents the maximum voltage that can be applied to the plate and still maintain linearity of operation. The point of flattening can be materially raised or lowered by raising or lowering the grid excitation or by the adjustment of the load impedance.

In Fig. H4 the output is linear up to $2E_c$ and since the modulating voltage must vary the r-f output current to 0 and up to twice the carrier value for 100% modulation, the plate voltage should be set at E_c and modulated up to $2E_c$ and down to 0. The peak plate voltage is, therefore, twice the carrier d-c plate voltage. The plate current will also vary linearly with plate voltage and the peak instantaneous plate current will be twice the carrier d-c plate current. With a sine wave modulating voltage applied, the plate current variations will be symmetrical around the carrier value and a d-c plate current meter will read the steady carrier value.

The apparent resistance of the tube to the variation in plate voltage is, therefore,

$$R = \frac{E_p}{I_p} \quad \text{(HVIII)}$$

E_p = D-C Plate Voltage
 I_p = D-C Plate Current

This is the resistance load of the modulator.

The plate input power under carrier conditions is:

$$P_c = E_p I_p \quad \text{(HIX)}$$

The peak plate input power at 100% modulation is:

$$P = 2E_p \times 2I_p = 4P_c \quad \text{(HX)}$$

which is four times the carrier input power.

The average audio power input at 100% modulation is:

$$P_{af} = 0.707E_{ar} \times 0.707I_{ar} = 0.5E_{ar}I_{ar} = 0.5E_pI_p \quad \text{(HXI)}$$

E_{ar} = Peak Modulating Voltage
 I_{ar} = Peak Modulating Current

This is 1/2 the carrier input power. Therefore, the a-f power required for complete modulation is equal to 50% of the carrier input power. If it is assumed that the tube efficiency is to remain constant over the audio cycle, the plate dissipation of the tube is increased by 50% under steady 100% modulation conditions. For incomplete modulation, that is, for modulation with a factor of M,

R = Modulator Load
 P_c = Power Input (Carrier)
 M = Modulation Factor

$$R = \frac{E_p}{I_p} \quad \text{(HVIII)}$$

$$P_c = E_p I_p \quad \text{(HIX)}$$

$$\text{Peak Plate Voltage} = E_p(1+M) \quad \text{(HXII)}$$

$$\text{Peak Plate Current} = I_p(1+M) \quad \text{(HXIII)}$$

$$\text{Peak Power Output} = E_p I_p (1+M)^2 \quad \text{(HXIV)}$$

$$\text{Avg. Mod. Power} = 0.5 E_p I_p M^2 \quad \text{(HXV)}$$

HEISING MODULATION SYSTEM The modulating power may be coupled into the plate circuit of the modulated tube in two different ways. The first and original system is the Heising or so called constant current system. Operation is accomplished by feeding the d.c. to the modulator and Class C amplifier plates through an audio choke, as shown in Fig. H5. If the grid of the modulator is excited, the plate current will vary at an audio rate which will develop an audio voltage across the choke which adds and subtracts from the d-c voltage applied to the plate of the Class C amplifier tube. However, even though the modulator tube is capable of supplying adequate power for modulating the Class C stage, it is impossible to completely modulate the carrier by this system since both the modulator plate and the Class C plate operate from the same d-c source and the a-c swing of the modulator plate can never be large enough to drive the plate voltage of the modulated tube to zero. For a pentode modulator, symmetrical modulation up to about 80% is possible and with a triode modulator, modulation up to about 65% can take place with Heising modulation.

PLATE AND SCREEN MODULATED RK-20A -A-

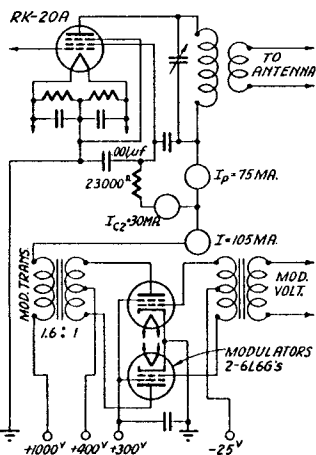

FIG. H9

PLATE & SCREEN MODULATION OF RK-20A BY MEANS OF THREE WINDING MODULATION TRANS. -B-

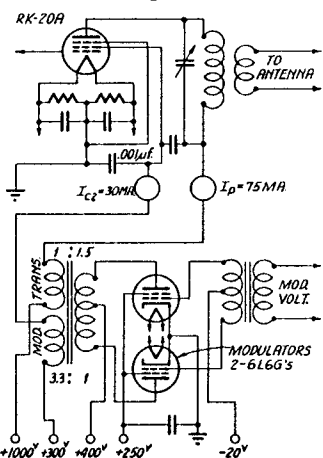

FIG. H9

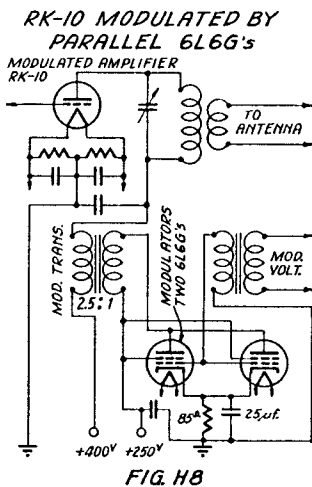

FIG. H8

In order to reach 100% modulation it is customary to lower the d-c plate voltage of the modulated tube. Assuming that the modulator can supply the modulating power required, the oscillator plate voltage should be dropped to about 65% of the modulator plate voltage for a triode modulator and to about 80% for a pentode modulator, as shown in Fig. H6.

Since the impedance match in this system is 1:1 the load of the Class C stage must be the optimum load for the modulator if full output is to be secured. The load of the modulator is usually too high for optimum output. The d-c resistance of a Class C stage varies from 5000 ohms upwards while the optimum modulator loads usually vary from about 7000 ohms downward. In very few instances it is possible, therefore, to get a good impedance match, power is wasted and more modulator capacity has to be installed to handle complete modulation. Of course, it is always possible to load the Class C stage until the d-c plate resistance exactly equals the load resistance of the modulator but this usually results in an inefficient Class C stage.

TRANSFORMER COUPLING TO MODULATOR

To match the impedances correctly and at the same time to take care of cases where push-pull or Class B modulators are used, a transformer must be employed as shown in Fig. H7. The turns ratio of the transformer will vary as the square root of the impedances to be matched. If push-pull or Class B modulators are used the load of the modulator should be taken plate to plate and then the whole primary matched to the whole secondary on this basis. The transformer must be capable of carrying the d-c plate current of the modulated stage as well as the a-c voltages and currents developed in the windings.

PUSH-PULL MODULATOR For a typical calculation let us assume that an RK-11 is to be plate modulated and it is required to find a suitable modulator and a coupling transformer. The recommended input for Class C phone operation is:

$$E_p = 600 \text{ volts and } I_p = 85 \text{ ma.}$$

The power input is: $E_p I_p = 600 \times 0.085 = 51 \text{ watts.}$

The modulator must furnish: $\frac{51}{2} = 25.5 \text{ watts.}$

The load resistance to which the modulator load must be matched is: $\frac{600}{0.085} = 7060 \text{ ohms.}$

Now considering a suitable modulator, two 6L6G's operating self-biased, Class AB₁ will deliver 32 watts to a load of 6600 ohms plate to plate. If a small loss is allowed in the transformer, this modulator should be just about adequate. The turns ratio of the transformer should be:

$$\frac{n_p}{n_s} = \sqrt{\frac{6600}{7060}} = 0.97$$

This is the ratio of the whole primary to the whole secondary. The primary is of course center tapped and the transformer must be capable of delivering 38.0 watts with 85 milliamperes d.c. flowing through the secondary.

A transformer ratio of whole primary to whole secondary of 1:1 would probably be satisfactory.

RK-42 OSCILLATOR AND RK-42 MODULATOR

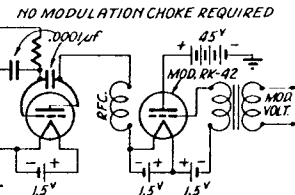

FIG. H10

SINGLE ENDED MODULATOR

For a single ended case, suppose an RK-10 is to be modulated. The RK-10 is being operated Class C at a plate voltage of 400 volts and a plate current of 50 milliamperes under carrier conditions.

The carrier power input is $400 \times 0.05 = 20 \text{ watts.}$

The load resistance is $\frac{400}{0.05} = 8000 \text{ ohms.}$

The modulator power required is $\frac{20}{2} = 10 \text{ watts.}$

Two 6L6G's operating in parallel, Class A can supply 13 watts to a load of 1250 ohms with 250 Volts plate and screen and with self-bias.

The ratio of primary to secondary turns is:

$$\frac{n_p}{n_s} = \sqrt{\frac{1250}{8000}} = 0.39$$

The transformer, therefore, should have a turns ratio of primary to secondary of approximately 0.4 and be capable of delivering 13 watts of audio with a d-c primary current of 160 milliamperes and a d-c secondary current of 50 milliamperes. The circuit is shown in Fig. H8.

PLATE MODULATION OF PENTODES

To plate modulate tubes like the RK-23, RK-20A and RK-28, it is necessary to modulate the screen at the same time, if modulation is to take place at plate voltages that are at all comparable with the maximum permissible plate voltages for the tubes. This is usually accomplished either by the use of a three winding modulation transformer, as shown in Fig. H9B, or by supplying the screen from a dropping resistor connected to the modulated plate supply, as shown in Fig. H9A. The second method is usually the simplest and cheapest to set up but a good deal of power is wasted in the dropping resistor to the screen, which is not true of the first method. Calculations for systems using the dropping resistor are carried out exactly as for plate modulation but with the screen current added to the plate current to obtain the modulating power, and the load resistance for the modulator stage.

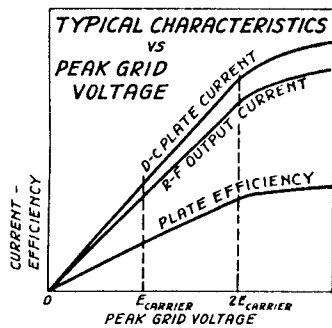

FIG. H11

GRID BIAS MODULATION

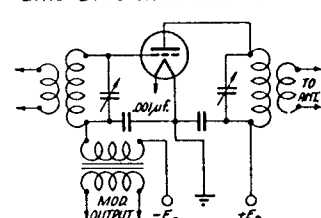

FIG. H12

PLATE AND SCREEN MODULATION OF RK-20A For an RK-20A to be plate and screen modulated the currents and voltages under carrier conditions are:

$$I_p = 62 \text{ ma.} \quad E_p = 900 \text{ volts}$$

$$I_{c2} = 50 \text{ ma.} \quad E_{c2} = 300 \text{ volts}$$

The screen voltage is to be dropped from 900 volts (plate supply) to 300 volts, and the screen resistor is $900-300/0.05 = 12,200$ ohms.

The total current to be modulated is $62 + 50 = 112$ ma.

The power input to be modulated is $0.112 \times 900 = 100.8$ watts.

The modulating power to be supplied is $100.8/2 = 50.4$ watts.

The load resistance is $900/0.112 = 8000$ ohms (approx.).

The versatile 6L6G can be again called upon to supply the necessary power for modulation, for two 6L6G's operating Class AB₂ at 400 volts plate and 300 volts screen can supply 60 watts to a 3800 ohm load.

The matching transformer, therefore, should have a turns ratio from plate to plate of the primary to the secondary of:

$$\frac{n_p}{n_s} = \sqrt{\frac{3800}{8000}} = 0.69 = 0.7 \text{ (approx.)}$$

When an RK-20A is operating in this fashion almost 50% of the modulator power is being wasted in the screen resistor.

PLATE MODULATION OF ALIGNED GRID TETRODES Now, if sufficient excitation could be applied to the conventional pentode, modulation by means of the plate alone would be possible. However, the screen will be overloaded before sufficient excitation is applied. The aligned grid tubes, because of reduced screen current, can have considerably more excitation applied before the screen overloads and can be plate modulated at reasonable plate voltages. Plate modulation of these types can be carried out exactly as with triodes, if excitation is such that the screen is loaded to its maximum rated current. Linearity of operation is improved by using a screen dropping resistor from the unmodulated plate supply and by-passed for r.f. only.

SERIES MODULATION For small transmitters where more than adequate voltage is available, modulation is possible by the series modulation scheme shown in the diagram in Fig. H10. The plate voltage must be about twice that desired on the modulated tube and complete modulation

to handle a 100% modulated r-f signal at the grid, the bias must be set at exactly plate current cutoff or less. Since the maximum possible efficiency of this system is 78.5% , the maximum possible carrier efficiency is $78.5/2$ or 39.25% . Usually Class B efficiencies run about 33% . For grid bias systems of modulation one is not restricted to cutoff operation and the maximum efficiency of this system is $1/2$ the maximum possible with a Class C amplifier or $100/2 = 50\%$. However, in order to conserve driving power, operation usually takes place at about 1.5 times cutoff where the carrier efficiency is about 35% .

Grid bias modulation and Class B linear amplifiers are known as efficiency modulation systems, since the average output power increases under modulation although the plate input power remains constant. This can only take place by a change in efficiency, the mechanism of which has been described. In either system the plate current should remain constant at the carrier value under modulation. It should be noted that a Class B linear amplifier is used to amplify an already modulated wave while with grid bias modulation the modulation takes place in the grid modulated stage itself.

MODULATION BY OTHER GRIDS If the voltage on the screen or suppressor grid is varied, efficiency modulation can also take place. The maximum theoretical carrier efficiency of either of these systems is $1/2$ the theoretical Class C efficiency or 50% . The usual efficiency is of the order of 35% . The effect of shifting the screen or the suppressor grid voltage is to change the plate current vs. grid voltage characteristic in such a manner as to increase the minimum plate voltage for a fixed load. Reduced efficiency is the result. All systems of efficiency modulation require little modulating power and for this reason are particularly attractive. However, there is some question whether they are as economical as a smaller tube operating with the same carrier output at high efficiency and modulated by means of the plate. Circuits for screen and suppressor grid modulation are shown in Fig. H13 and Fig. H14.

CLASS B R-F AMPLIFIER ADJUSTMENT At first it may be stated that the adjustment of a Class B R-F stage is difficult to carry out perfectly without an oscillograph or other means of measurement where the effect of circuit and voltage changes can be noted. In the absence of an oscillograph, the simplest method is to set the bias of the Class B stage to cutoff or slightly less and vary the coupling to the driver, without modulation, until maximum output is obtained and then to reduce the excitation until the output current is $1/2$ of its previous value. Modulation can then take place around this point.

DRIVERS FOR CLASS B LINEAR AMPLIFIERS In setting up a Class B stage the design of the driver is of great importance. The driver is usually a modulated Class C stage, although another Class B tube may be used as a driver. For a given Class B output tube, the driver should be capable of supplying at the modulation peaks an r-f voltage that is equal to the peak of the r-f voltage required by the output tube. If it is insufficient, the full capabilities of the Class B stage are not being utilized. If it is too great, distortion results. For a tube like the RK-38, operating at a bias of -100 volts, the peak grid swing should be 300 volts at the crest of the r-f cycle. At this point the r-f power required is about $0.9 \times 300 \times 0.025 = 6.8$ watts, so that the driver must be capable of supplying at least 6.8 watts, if it is to supply sufficient power at the audio peaks.

The average r-f impedance of the grid at this point is $300^2/6.8 = 13200$ ohms.

Under the carrier conditions, the peak grid voltage is 150 volts, the grid current is about 3 milliamperes and the power input is $150 \times 0.0025 \times 0.9 = 0.34$ watts, and the average grid impedance is $150^2/0.34 = 66000$ ohms.

On the downward modulation swing the grid impedance increases and when the positive modulation peaks are less than the bias, the grid impedance is infinite. The grid of the Class B stage, therefore, presents a varying load to its driver. If the driver is to be maintained linear, its load should be constant. To bring this about, it is customary to shunt the Class B grid with an additional load resistor. The impedance of this resistor will be linear over the cycle and tend to make the average load impedance linear also. The greater the power absorbed by this resistor, as compared to the power taken by the Class B grid, the more linear will be the load on the driver stage. Usual practice is to use up about 50% of the carrier power of the driver stage in the shunting resistor. This probably represents the very minimum that should be used. Fig. H15 shows the effect of various shunting resistances on the linearity of the load presented to the driver tube.

Other driver considerations are the peak power output and the peak voltage. Thus, for the RK-38 a peak voltage of 300 volts is required at the modulation peaks. The carrier voltage supplied from the driver should be $1/2$ of this or 150 volts. The peak power required is 6.8 watts which means that the driver carrier power should be at least $1/4$ of this or 1.7 watts, if it is to be capable of supplying the peaks of the r-f cycle. Since about 50% of the power is to be used up in a loading resistor, a driver carrier of about 3.5 watts is necessary. It would be best to select a carrier value that is about twice this and tap down on the driver coil for optimum excitation. It is essential to use some system by means of which the excitation can be varied for adjustment purposes. Unless this is done, adjustment for optimum conditions can never be realized except by chance.

BIAS SOURCE FOR CLASS B LINEAR STAGES The bias source plays an important part in the overall linearity of a Class B stage. A tendency for the output to be too high at the modulation peaks can be corrected by adding some variable bias in the control grid circuit. A cathode resistor will have a similar effect. Both of these should be by-passed for r.f. only.

It has always been more or less accepted by amateurs that a Class B stage should be set at exactly cutoff. This is not true and with this condition it is impossible to obtain linear modulation. If the bias is reduced so that some plate current flows with no excitation, the performance of the Class B stage will be very greatly improved. Initial plate currents with no excitation up to $2/3$ rated plate dissipation are permissible. Bias values greater than cutoff are of course out of the question because the negative modulation peaks will be completely cutoff.

GRID BIAS MODULATION ADJUSTMENT Closely allied with Class B operation is the operation of the grid bias modulated stage. In general, the bias should be set at a value that is about the cutoff value for the plate voltage used and the load and excitation adjusted for maximum output. The grid bias is then increased maintaining the excitation approximately constant until the antenna current reaches $1/2$ of its initial value. In the absence of an antenna meter the plate milliammeter can be used as an indication of the reduction in output. Modulation can then take place at this point. Initial bias values greater than cutoff can be used and

SCREEN MODULATION

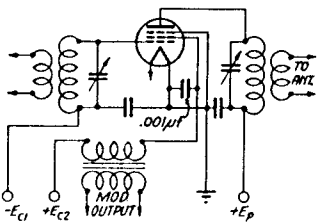

FIG. H13

SUPPRESSOR GRID MODULATION

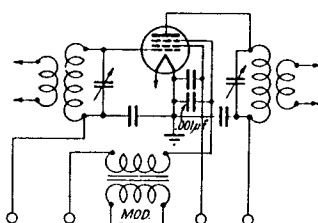

FIG. H14

is generally not possible without extreme distortion. Perfect impedance matching cannot of course be realized. Unless cathode type tubes are used, separate filament supplies are required. Such a system, because it eliminates the usual modulation choke or transformer, can be used to modulate over an extremely wide frequency range with negligible frequency attenuation.

NEUTRALIZATION OF MODULATED AMPLIFIERS Tubes that are neutralized for the carrier but are just on the edge of oscillation, will often break into oscillation on the modulation peaks. This is, of course, to be avoided. The only remedy is to improve the neutralization.

GRID MODULATION For a given grid bias, if the excitation is increased, the power output will increase linearly with excitation for a time until a point is reached where it will flatten off, as shown in Fig. H11. If measurements were made at this point of the instantaneous plate and grid voltages, it would be found that the maximum grid voltage was approximately equal to the minimum plate voltage. For given d-c grid and plate voltages this point represents the maximum possible plate voltage swing, which in turn permits the maximum plate efficiency. Below this point the plate efficiency decreases almost linearly with grid excitation. Now the peak grid voltage which determines the minimum plate voltage is composed of the d-c bias voltage plus the r-f excitation voltage. To vary the peak grid voltage, therefore, either of these components can be varied. If the grid bias voltage is varied, a type of modulation is possible which is known as grid bias modulation. A circuit for grid bias modulation is shown in Fig. H12. If the r-f excitation voltage is varied the system is known as a Class B r-f amplifier or as a linear amplifier.

CARRIER EFFICIENCY OF GRID MODULATED AND CLASS B R-F AMPLIFIERS

Since the modulated output is varied up and down from a carrier value, the carrier must be set at a value that gives half of the peak voltage output. The excitation is, therefore, reduced and the efficiency under carrier conditions is approximately $1/2$ of the peak efficiency. For Class B linear operation, in order

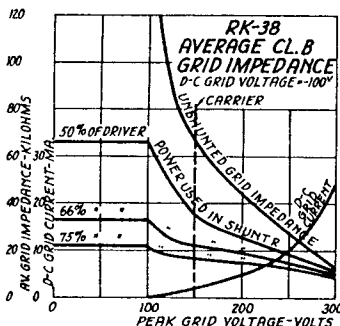

FIG. H15

will increase the carrier efficiency but inasmuch as the maximum theoretical carrier efficiency is only 50%, it is doubtful if efficiencies of more than 40% are possible. A carrier bias value of between double and 1.5 times cutoff is reasonable. Larger bias values increase the efficiency but the adjustment of the amplifier becomes critical and the r-f driving power is appreciably increased.

AUDIO POWER FOR GRID MODULATION If the peak r-f driving voltage and the d-c grid current at the peak of the modulated cycle and the modulating voltage are known, it is possible to calculate the peak audio power required for modulation. At the peak of the cycle the driving power can be calculated exactly by methods that have been described under "Driving Power and the Exciter" and is approximately:

$$P_d (\text{Peak}) = 0.9 \times E_{rr} I_{dc}$$

$$E_{rr} = \text{Peak R-F Grid Voltage}$$

$$I_{dc} = \text{Grid Current at Peak of Audio Cycle}$$

The average impedance of the grid at this point is:

$$Z_g = \frac{P_d}{0.5 (E_{rr})^2} = \frac{0.9 I_{dc}}{0.5 (E_{rr})^2} \quad (\text{HXVI})$$

Since the audio voltage is applied across this average impedance.

$$E_{ar} = \text{Peak Audio Voltage} \quad P_{ar} (\text{peak}) = \frac{0.9 (E_{ar})^2 \times I_{dc}}{E_{rr}} \quad (\text{HXVII})$$

$$P_{ar} = \text{Peak Audio Power} \quad P_{ar} (\text{peak}) = \frac{0.9 (E_{ar})^2 \times I_{dc}}{E_{rr}} \quad (\text{HXVIII})$$

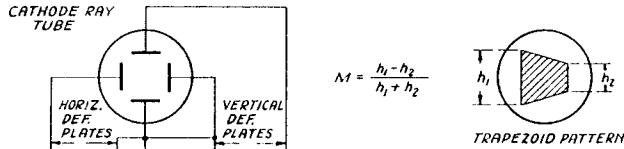

FIG. H16

The peak audio power required is also equal to:

$$P_{ar} (\text{peak}) = \frac{P_d \times (E_{ar})^2}{(E_{rr})^2} \quad (\text{HXIX})$$

GRID IMPEDANCE OF GRID BIAS MODULATED STAGE The grid impedance of a grid bias modulated stage varies widely over the audio cycle in much the same manner as in a Class B R-F stage. The grid impedance over the negative excursion of the

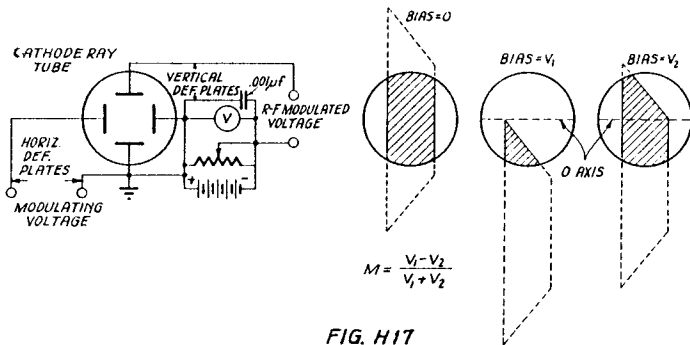

FIG. H17

a-f cycle is infinite, while it drops to very low values during the positive swing. In order that the load of the modulator tube be more nearly constant, it is usual to use up a good deal of power in a shunting load resistor. In general, the power required for grid bias modulation is quite low as compared to the audio power that can be made available and the cost of the additional power that must be expended in the shunting resistor is small compared to the improvement in fidelity that is realized. Since the r-f grid impedance of a grid bias modulated stage varies in much the same manner as the grid impedance of a Class B linear stage, similar precautions should be taken in the design of the driver if optimum results are to be obtained.

SUPPRESSOR GRID MODULATION Modulation by means of the suppressor grid is about the simplest modulation scheme that has yet been devised. The power required is negligible and the adjustments are minor. A further advantage is that, due to the trailing off of the suppressor grid characteristic in the negative direction, it is almost impossible to over-modulate. Suppressor grid modulation does however possess two disadvantages. First, beyond about 80% modulation the distortion increases rapidly (this to a certain extent is advantageous because it prevents over-modulation) and second, suppressor modulation is limited to a carrier efficiency on the order of 35%. The mechanism of suppressor modulation is to vary the minimum plate voltage for a given excitation and inasmuch as the signal must vary up and down from the carrier value, the carrier must be set at a relatively high minimum plate voltage with resultant poor efficiency.

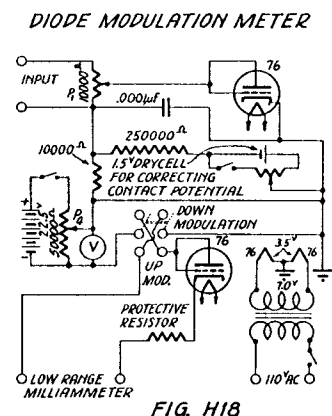

FIG. H18

ADJUSTMENTS FOR SUPPRESSOR GRID MODULATION The general procedure in setting up a suppressor grid modulated amplifier is to adjust the load and the excitation to give optimum output at maximum suppressor voltage and then to reduce the current output to one-half the peak value by increasing the suppressor voltage in a negative direction. At this point modulation can take place. An oscillograph may be utilized for the purpose of determining the quality of the modulation. If difficulty is encountered in reaching the positive peaks the excitation should be increased or the loading reduced. It will be found that the point of optimum suppressor bias may vary with frequency, possibly due to some transit time effect or to voltages built up across impedances in the suppressor grid circuit. For instance, at 80 meters, -45 volts is usually the optimum value, at 20 meters, between -60 and -90 volts is usually necessary and at 10 meters still higher voltages are required. It is usually best to obtain the maximum output at -45 volts on the suppressor and then reduce the plate current to one-half or better still, the antenna current to one-half the maximum value by increasing the suppressor bias negatively.

CALCULATION OF SUPPRESSOR MODULATING POWER Over the modulation cycle the suppressor is substantially negative and the power required for modulation can be calculated in a manner quite similar to the methods employed for the calculation of grid driving power.

The power required is approximately:

$$E_{ar} = \text{Peak audio voltage supplied to the suppressor}$$

$$I_{cs} = \text{D-C suppressor grid current under steady modulation}$$

$$P_{ar} = \text{A-F modulating power}$$

$$P_{ar} = 0.9 E_{ar} I_{cs} \quad (\text{HXX})$$

In Fig. H14 is shown a typical suppressor modulated amplifier. Again, to keep the amplifier load as linear as possible, a load resistor is used.

MODULATION MEASUREMENTS—CATHODE RAY OSCILLOGRAPH The easiest and quickest method of determining modulation percentage and distortion is by the use of a cathode ray oscillograph. If some of the modulating voltage is applied to the horizontal plates at the same time that some of the modulated r-f voltage is applied to the vertical plates, as shown in Fig. H16, trapezoidal figures result. The modulation percentage can be determined by measurement of the actual heights of the sides of the trapezoid and the modulation percentage is given by:

$$m = \frac{h_1 - h_2}{h_1 + h_2} \quad (\text{HXXI})$$

More accuracy is possible by the use of a larger pattern but usually the figure becomes quite distorted. A more accurate method that allows the use of a larger pattern and one where the relative widths of the trapezoid are quickly measured, is to bias the vertical plates by means of a potentiometer and battery, as shown in Fig. H17. If the center line of the oscillograph is noted, the bias necessary to bring each peak to the center line is a measure of the relative heights of the peaks and the percentage modulation can be calculated. This method eliminates the effect of any possible distortion in the oscillograph plates or screen, in fact, in a vertical direction the figure can be much larger than the screen itself.

DIODE MODULATION METER A common method of measuring modulation is by the use of two diodes, as shown in Fig. H18. The 10000 ohm potentiometer adjusts the r-f voltage applied to the diode to about 10 volts. The carrier value can be measured without modulation and the upward and downward modulation peaks measured by setting the switch to the modulation desired and adjusting the indicator to zero by means of the 50000 ohm potentiometer.

The upward modulation is then:

$$E_r = \text{Carrier value}$$

$$E_1 = \text{Positive peak value}$$

$$m_1 = \frac{E_1 - E_r}{E_r} \quad (\text{HXXII})$$

and the downward modulation is:

$$E_r = \text{Carrier value}$$

$$E_2 = \text{Negative peak value}$$

$$m_2 = \frac{E_r - E_2}{E_r} \quad (\text{HXXIII})$$

or the average modulation:

$$m = \frac{E_1 - E_2}{E_1 + E_2} \quad (\text{HXXIV})$$

This method has disadvantages. It is not accurate above 3000 cycles because of the effects of diode loading. Contact potential effects in the diodes mask the accuracy of the instrument in the vicinity of 80%—100% modulation, although in the instrument described contact potential can be to a certain extent cancelled by means of the 1.5 volt bucking battery. With no signal applied and the potentiometer, P_1 , set to zero, the potentiometer, P_2 , should be adjusted so that no current flows in the indicating device.

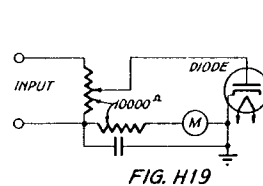

FIG. H19

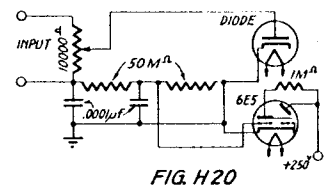

FIG. H20

OVER-MODULATION INDICATORS A meter that is useful in showing up over-modulation or carrier shift is shown in Fig. H19. It is a simple diode rectifier plus a potentiometer to vary the voltage applied to the diode. Overmodulation will show up as a shifting meter-reading as the transmitter is being modulated. Another device that is cheaper is a 6E5 type indicator, as shown in Fig. H20. In operation, the coupling to the transmitter is adjusted until the magic eye deflection is reduced about one-half. As the modulation is varied there should be no changes in the deflection of the magic eye.

RAYTHEON AMATEUR TUBES

TABLE I
MODULATING POWER FOR PLATE MODULATION (100%)

| TYPE | CARRIER CONDITIONS | | | | Modulating Watts | Matching Impedance Ohms | Modulation Trans. Turns Ratio Total Primary to Total Secondary | Modulator Tubes See Table II |
|------------|--------------------|---------------|-------------|--------------|------------------|-------------------------|--|------------------------------|
| | D-C Plate Volts | D-C Plate Ma. | Input Watts | Output Watts | | | | |
| RK-10 (1) | 350 | 50 | 17.5 | 12 | 9 | 7000 | 1:1.32 | A |
| RK-10 (2) | 350 | 100 | 35 | 24 | 18 | 3500 | 1.56:1 | C |
| RK-11 (1) | 600 | 85 | 51 | 38 | 26 | 7060 | 1:1 | D |
| RK-11 (2) | 600 | 170 | 102 | 76 | 51 | 3530 | 1:1 | F |
| RK-12 (1) | 600 | 85 | 51 | 35 | 26 | 7060 | 1:1 | D |
| RK-12 (2) | 600 | 170 | 102 | 70 | 51 | 3530 | 1:1 | F |
| RK-18 (1) | 1000 | 80 | 80 | 64 | 40 | 12500 | 1:1.82 | F |
| RK-18 (2) | 1000 | 160 | 160 | 128 | 80 | 6250 | 1.24:1 | H |
| RK-20A*(1) | 1000 | 105† | 105 | 52 | 53 | 9530 | 1:1.58 | F |
| RK-20A*(2) | 1000 | 210† | 210 | 104 | 105 | 4765 | 1.42:1 | H |
| RK-23 *(1) | 400 | 73 † | 29 | 13.5 | 15 | 5500 | 1.35:1 | B |
| RK-23 *(2) | 400 | 146† | 58 | 27 | 29 | 2750 | 1.48:1 | E |
| RK-25 *(1) | 400 | 73 † | 29 | 13.5 | 15 | 5500 | 1.35:1 | B |
| RK-25 *(2) | 400 | 146† | 58 | 27 | 29 | 2750 | 1.48:1 | E |
| RK-28 *(1) | 1500 | 187† | 280 | 155 | 140 | 8000 | 1.5 :1 | K |
| RK-28 *(2) | 1500 | 374† | 560 | 310 | 280 | 4000 | 2:1 | M |
| RK-30 (1) | 1000 | 80 | 80 | 60 | 40 | 12500 | 1:1.82 | F |
| RK-30 (2) | 1000 | 160 | 160 | 120 | 80 | 6250 | 1.24:1 | H |
| RK-31 (1) | 1000 | 100 | 100 | 70 | 50 | 10000 | 1:1.62 | F |
| RK-31 (2) | 1000 | 200 | 200 | 140 | 100 | 5000 | 1.39:1 | H |
| RK-32 (1) | 1000 | 100 | 100 | 70 | 50 | 10000 | 1:1.62 | F |
| RK-32 (2) | 1000 | 200 | 200 | 140 | 100 | 5000 | 1.39:1 | H |
| RK-34 (1) | 300 | 80 | 24 | 16 | 12 | 3750 | 1.63:1 | B |
| RK-35 (1) | 1250 | 100 | 125 | 93 | 63 | 12500 | 1:1.18 | G |
| RK-35 (2) | 1250 | 200 | 250 | 186 | 125 | 6250 | 1.33:1 | J |
| RK-36 (1) | 2000 | 150 | 300 | 200 | 150 | 13300 | 1.16:1 | K |
| RK-36 (2) | 2000 | 300 | 600 | 400 | 300 | 6650 | 1.55:1 | M |
| RK-37 (1) | 1250 | 100 | 125 | 90 | 63 | 12500 | 1:1.18 | G |
| RK-37 (2) | 1250 | 200 | 250 | 180 | 125 | 6250 | 1.33:1 | J |
| RK-38 (1) | 2000 | 160 | 320 | 225 | 160 | 12500 | 1.2 :1 | K |
| RK-38 (2) | 2000 | 320 | 640 | 450 | 320 | 6250 | 1.6 :1 | M |
| RK-39 (1) | 400 | 60 | 24 | 17 | 12 | 6670 | 1.23:1 | B |
| RK-39 (2) | 400 | 120 | 48 | 34 | 24 | 3335 | 1.34:1 | E |
| RK-41 (1) | 400 | 60 | 24 | 17 | 12 | 6670 | 1.23:1 | B |
| RK-41 (2) | 400 | 120 | 48 | 34 | 24 | 3335 | 1.34:1 | E |
| RK-47 (1) | 900 | 80 | 72 | 50 | 36 | 11250 | 1:1.72 | F |
| RK-47 (2) | 900 | 160 | 144 | 100 | 72 | 5625 | 1.27:1 | G |
| RK-48 (1) | 1500 | 148 | 222 | 165 | 111 | 10100 | 1:1 | J |
| RK-48 (2) | 1500 | 296 | 444 | 330 | 222 | 5050 | 1:1.12 | L |
| RK-49 (1) | 300 | 60 | 18 | 12 | 9 | 5000 | 1.41:1 | A |
| RK-49 (2) | 300 | 120 | 36 | 24 | 18 | 2500 | 1.85:1 | C |
| RK-51 (1) | 1250 | 105 | 131 | 96 | 66 | 11900 | 1:1.15 | G |
| RK-51 (2) | 1250 | 210 | 262 | 192 | 131 | 5950 | 1.36:1 | J |
| RK-52 (1) | 1250 | 115 | 144 | 105 | 72 | 10900 | 1:1.1 | G |
| RK-52 (2) | 1250 | 230 | 288 | 210 | 144 | 5450 | 1.42:1 | J |

(1) Single Tube

(2) Two Tubes—Push Pull or Parallel

* Plate and Screen Modulation with Series Screen Resistor

† Sum of D-C Plate Current and D-C Screen Current

TABLE II
RECOMMENDED MODULATOR TUBES

| TYPE | Class | OPERATING CONDITIONS | | | | | | See Table I |
|---------|-----------------|----------------------|------------------|----------------|--------------------|--------------|---------------------|-------------|
| | | D-C Plate Volts | D-C Screen Volts | D-C Grid Volts | Bias Resistor Ohms | Output Watts | Load Impedance Ohms | |
| 1-6L6G | A | 375 | 250 | -17.5 | Fixed-Bias | 11.5 | 4000 | A |
| 2-6F6G | AB ₂ | 375 | 250 | Self-Bias | 340 | 19 | 10000 | B |
| 2-6L6G | AB ₁ | 400 | 250 | Self-Bias | 190 | 24 | 8500 | C |
| 2-6L6G | AB ₁ | 400 | 300 | Self-Bias | 200 | 32 | 6600 | D |
| 2-6L6G | AB ₂ | 400 | 250 | -20 | Fixed-Bias | 40 | 6000 | E |
| 2-6L6G | AB ₂ | 400 | 300 | -25 | Fixed-Bias | 60 | 3800 | F |
| 2-RK-12 | B | 700 | — | 0 | — | 80 | 9000 | G |
| 2-RK-12 | B | 750 | — | 0 | — | 100 | 9600 | H |
| 2-RK-31 | B | 1000 | — | 0 | — | 160 | 11000 | J |
| 2-RK-31 | B | 1250 | — | 0 | — | 190 | 18000 | K |
| 2-RK-52 | B | 1250 | — | 0 | — | 250 | 10000 | L |
| 2-RK-38 | B | 2000 | — | -52 | Fixed-Bias | 330 | 16000 | M |

FIG. H21

Fig. H21 is a tabulation of the requirements for plate modulation of Raytheon Amateur Tubes and recommended modulator tubes, and will be found useful in designing modulation equipment.

DETECTOR PERFORMANCE

The introduction of separate diodes which may be used for diode rectification and AVC has resulted in several types of detector tubes. Not much information as to the relative performance of the various types of tubes has been available so that the amateur has not had the information to enable him to choose the best type of detector tube for his particular purpose. This section summarizes the results of an experimental study of the performance of the various types of detector tubes now available.

The performance of the various types of tubes are shown on the accompanying chart in Fig. R1. It would have been impossible of course to have plotted curves for all the conditions under which the various types of tubes might be used. Resistance coupling was used in all cases, and it is believed that the values of resistances chosen represent close to the optimum values considering both sensitivity and distortion. The results given for the lower impedance tubes such as the 27, 55 and 85 types may, of course, be easily changed to transformer coupling by well known methods of circuit analysis. The values of resistors, voltages, etc. are indicated in the tabulation.

Four types of circuits were used in this study and are shown in Fig. R1. Circuit A shows the circuit used in the case of the diode. The output using a diode, as shown plotted in the figure, is linear because the input given is 5 volts or more. With smaller input voltages there would have been more curvature. Circuit B was used for the conventional tubes such as the 24A, 27, 57, 6C6 and 6J7G types. The operation of these types is obvious and of course requires no further comments except that G refers to grid circuit detection and P to plate circuit detection.

Circuit C, in Fig. R1, shows the connections for the 55 and 85 duplex diode-triode tubes. This connection is not the most favorable one as regards overload conditions because the bias is proportional to the carrier and consequently the tube is overbiased as the modulation voltage must be equal to or less than the carrier voltage. Enough output may be obtained generally with this connection but in AVC systems it is possible to obtain enough r-f voltage to overbias the triode section thus cutting off the plate current. A connection using a fixed bias, such as shown in circuit D of Fig. R1 may be used, in which case the output voltage will be raised considerably before overloading occurs since the triode bias is then independent of the carrier amplitude.

Circuit D was used for the types 75 and 6B6G. The 6Q7G will give approximately the same performance as the 6B6G. These tubes have a high-mu triode section in which the operating bias on the control grid must be close to the point where current starts so that the grid may draw current over part of the cycle at least. The resistance of one megohm in the grid circuit keeps the grid-cathode resistance high, thus preventing shorting of the diode leak resistor. This circuit has been investigated quite thoroughly experimentally and has been found to be satisfactory.

The 2B7, 6B7 and 6B8G tubes are duplex diode pentode tubes which have been introduced for two services. One is to use the pentode as a high frequency amplifier with the diodes used for rectification, AVC, etc. The other application is to use the diodes as rectifiers and the pentode section as an audio amplifier. It is the latter service which is of interest in this study. Two conditions for the 2B7, 6B7 and 6B8G are given. The curve labeled "X" is for 100 volts on the screen grid and represents conditions under which it is not desirable to reduce the screen voltage to values lower than that used for the other tubes. Condition "Y" is believed to represent the optimum conditions but requires a screen voltage of 45 volts and hence an extra voltage divider in the usual small receiver.

The experimental curves show one result that is rather startling on first thought. This is that it is possible to obtain with a high-mu triode with auxiliary diodes about as good sensitivity as with pentode tubes. Thus, in a small receiver the 75, 6B6G or 6Q7G tube will give practically as good sensitivity as the 24A, 57, 6C6 or 6J7G type detector tube and in addition allows AVC to be used. A duplex diode-pentode may be used also in this combination but will cost more for equal or even less sensitivity as the "X" curve for the 2B7, 6B7, 6B8G shows less sensitivity than the curve for the 75 and 6B6G. The duo-diode pentode types are necessarily more expensive than the duo-diode triode types and hence will cost more to incorporate in a receiver.

In general, a study of the diagram shows that duo-diode triode or pentode tubes will give improved circuit performance and flexibility. These tubes give about the same sensitivity as the 24A, 57, 6C6 tubes and in addition the diodes may be used for AVC, etc. The duplex diode triode types, such as the 55 and 85, give considerably better results than the type 27 or the newer triodes such as the 6J5C as regards sensitivity and overload and in addition they may be used for other circuit functions also, such as AVC, etc.

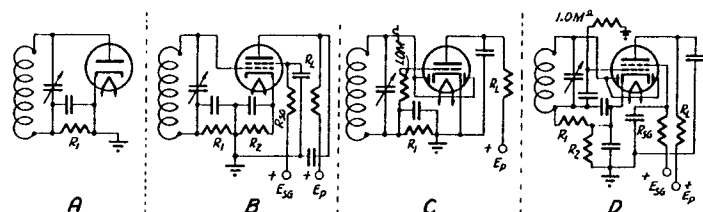
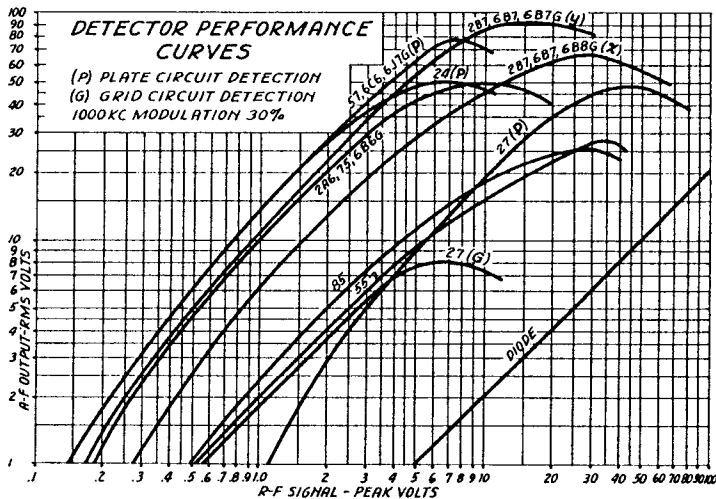

| TUBE | CIRCUIT | MEGOHMS | | | | VOLTS | | TUBE | CIRCUIT | MEGOHMS | | | | VOLTS | |
|---------|---------|----------------|----------------|-----------------|----------------|-----------------|----------------|---------|---------|----------------|----------------|-----------------|----------------|-----------------|----------------|
| | | R ₁ | R ₂ | R _{3g} | R _L | E _{sg} | E _p | | | R ₁ | R ₂ | R _{3g} | R _L | E _{sg} | E _p |
| DIODE | A | .5 | - | - | - | - | - | 75 | D | .5 | .004 | - | .25 | - | 250 |
| 27 (G) | B | .5 | - | - | .02 | - | 250 | 24A | D | .5 | .001 | 0 | .027 | 100 | 250 |
| 27 (P) | B | - | .035 | - | .25 | - | 250 | 2B7 | D | .5 | .001 | 0 | .027 | 100 | 250 |
| 24 (P) | B | - | .025 | .5 | .5 | 100 | 250 | 6B7 (X) | D | .5 | .001 | 0 | .027 | 100 | 250 |
| 57 | B | - | .025 | 0 | .5 | 90 | 250 | 6B8G | D | .5 | .0025 | 0 | .5 | 45 | 250 |
| 6C6 (P) | B | - | .025 | 0 | .5 | 90 | 250 | 2B7 | D | .5 | .0025 | 0 | .5 | 45 | 250 |
| 6J7G | B | - | .025 | 0 | .5 | 90 | 250 | 6B7 (Y) | D | .5 | .0025 | 0 | .5 | 45 | 250 |
| 85 | C | .5 | - | - | .03 | - | 250 | 6B8G | D | .5 | .0025 | 0 | .5 | 45 | 250 |
| 55 | C | .5 | - | - | .02 | - | 250 | | | | | | | | |

FIG. R1

ULTRA HIGH FREQUENCY OPERATION

Fundamentally, tube operation at the very high frequencies (above 14 megacycles) is the same as at lower frequencies except for the relative importance of such factors as interelectrode capacitance, lead inductance and resistance, and transit time losses. Practically, however, tube operation is quite different and due consideration must be given to tube and circuit conditions that are ordinarily so unimportant at the lower frequencies that they are completely neglected.

REDUCED RATINGS It is usually necessary to reduce the ratings of a transmitting tube when it is operated at the ultra high frequencies. All Raytheon Amateur Tubes may be operated at the maximum ratings up to 14 megacycles and a very large majority of them may be operated up to 30 megacycles at the maximum ratings. Beyond this frequency, however, most tubes, except those specially designed for high frequency operation, should be operated at reduced plate voltage and excitation. Several factors are responsible for the necessity of reducing the ratings. The first is lead heating due to the flow of heavy charging currents to the tube elements. Second, the tube effi-

efficiency is reduced due to transit time and impedance losses, and third, the circuits used with the tube are never particularly efficient and usually by themselves constitute a very heavy load for the tube. Due to the presence of these three factors, the overall efficiency of a tube and its associated circuit falls off rapidly with frequency, as shown by the curve in Fig. J4. How much the low frequency ratings should be reduced for high frequency operation depends entirely upon the extent to which these factors are present. Each factor will be discussed in detail so that by a careful consideration of all that is involved, the amateur may be able to fully appreciate some of the difficulties under which the tubes are expected to operate and by such appreciation be able to obtain from his tubes not only increased output but also more stable operation and longer life.

CHARGING CURRENTS

The passage of a heavy charging current through a tube lead causes a heating of that lead since the high frequency resistance of the lead is appreciable. The high frequency resistance of a lead varies directly as the square root of the frequency and some idea of how much the high frequency resistance of the lead differs from the d-c resistance may be gleaned from the fact that, at 56 megacycles, the r-f resistance of #14 copper wire is approximately forty times its d-c resistance. The lead, in turn, heats the glass seal. If the heating occurs in a stem lead close to another stem lead at a different a-c or d-c potential, the glass stem may be heated sufficiently to conduct and electrolysis of the glass may occur. Even though electrolysis does not occur, the heating of the glass may introduce a serious dielectric loss. If the lead is brought out of the side or the top of the bulb remote from other leads, the danger of electrolysis or dielectric loss is not very great but the heating still continues and the temperature of the glass may rise to a point where softening occurs and the glass collapses.

The magnitude of the charging currents depends upon the magnitude of the tube capacitances, the r-f voltages applied to the elements and the type of circuit in which the tube is being operated.

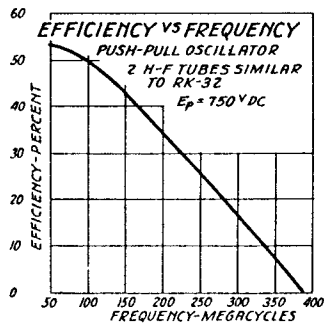

FIG. J4

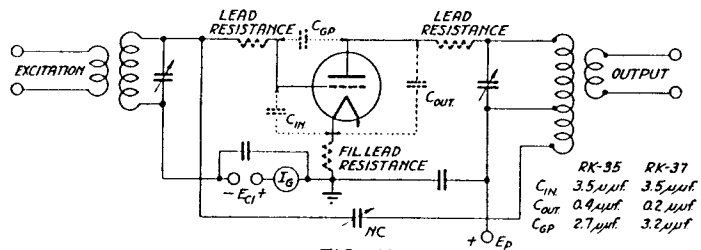

FIG. J1

AMPLIFIER OPERATION

For example, consider an RK-35 used as a 56 megacycle amplifier as in Fig. J1. First, the neutralizing condenser will be disconnected and only the grid voltages will be applied. If the excitation is increased until the d-c grid current has reached its rated value of 15 milliamperes, the peak r-f grid voltage is approximately 375 volts. This voltage is applied across the input capacitance of the tube paralleled by a network consisting of the grid to plate capacitance in series with the tuned plate circuit. Because of the resonant plate circuit, the impedance of this parallel network is very high as compared to that of the input capacitance and in this instance its effect may be neglected. The r-f grid charging current, therefore, flows through the grid to filament capacitance of the tube and, at 56 megacycles with no plate potential applied, the peak r-f grid charging current is $2\pi f C_{gm} = 6.28 \times 56 \times 10^6 \times 3.5 \times 10^{-12} \times 375 = 0.461$ ampere. At this frequency, the resistance of the grid lead can be neglected in solving for the r-f grid charging current since its resistance is very small compared to the capacitive reactance of the grid. It, of course, is used in evaluating the power being dissipated in the lead.

If an RK-37, which is a higher mu tube than the RK-35 and hence requires less driving voltage is used, the r-f grid charging current is somewhat smaller and is $6.28 \times 56 \times 10^6 \times 10^6 \times 3.5 \times 10^{-12} \times 260 = 0.32$ ampere.

If the plate voltage is applied and the amplifier perfectly neutralized, there can be no effect of the plate circuit on the control grid circuit and the r-f grid charging current is still determined by the conditions in the control grid circuit and will be the same as in the illustration. It is apparent that the r-f grid charging current in neutralized amplifier operation will be greatest for low mu tubes requiring a large driving voltage across a high input capacitance.

In pentodes, variations in the plate circuit are effectively screened from the control grid by the screen grid. However, the input capacitance of the average pentode is almost three times as great as that of the lowest capacitance triode. For this reason, even though the grid driving voltage is not particularly high, the r-f grid charging current may be serious. For the RK-20A at 56 megacycles with normal excitation, the grid charging current is $6.28 \times 56 \times 10^6 \times 11 \times 10^{-12} \times 180 = 0.696$ ampere.

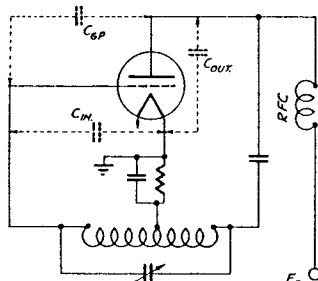

FIG. J2

Although the r-f plate voltage is considerably higher than the r-f grid voltage, the peak r-f plate charging current in triodes is not quite as serious as the r-f grid charging current because of the triode's low output capacitance. Thus, the peak r-f plate voltage of the RK-35 at approximately 70% efficiency can be shown to be roughly 0.8 times the d-c plate voltage, or 1200 volts. The peak r-f plate charging current is, therefore, $6.28 \times 56 \times 10^6 \times 0.4 \times 10^{-12} \times 1200 = 0.17$ ampere.

The output capacitance of the RK-37 is only 0.2 micromicrofarad and the peak r-f plate charging current in this case is only 0.085 ampere.

The output capacitance of pentodes, on the other hand, is very high and the r-f plate charging currents can reach correspondingly high values. Thus, the output capacitance of an RK-20A is 10 μ mf., and if the RK-20A were used at full ratings at 56 megacycles, the peak r-f plate charging current would be $6.28 \times 56 \times 10^6 \times 10 \times 10^{-12} \times 1000 = 3.5$ amperes.

The peak r-f plate charging current with an unloaded tank is larger than the loaded value and can be evaluated by assuming the peak r-f plate voltage to be equal to the d-c plate voltage.

OSCILLATORS When tubes are used as oscillators, the charging currents are considerably different from those encountered in neutralized amplifier applications. The r-f plate voltage is transferred into the grid circuit in such a manner as to give a dynamic input capacitance that can be many times larger than the static input capacitance of the tube. If the neutralizing condenser in Fig. J1 is omitted, the circuit becomes that of a tuned grid, tuned plate oscillator. While operating, the input capacitance can be shown to become:

$$C_{IN} \text{ (dynamic)} = C_{IN} \text{ (static)} + C_{gp} (1 + X)$$

$$X = (\text{approx.}) \frac{\text{r-f plate volt}}{\text{r-f grid volt}} \quad (J1)$$

In other words, the input capacitance now consists of the static capacitance plus an additional capacitance transferred from the plate circuit, which is a function of the grid to plate capacitance of the tube and the ratio of the r-f plate and grid voltages.

If the RK-35 is considered as a tuned grid, tuned plate oscillator running under the same conditions as it was as a straight amplifier, the peak r-f plate voltage is approximately $0.8 \times E_{dc} = 0.8 \times 0.8 \times 1500 = 1200$ volts. $X = 1200/375 = 3.2$.

The dynamic input capacitance is, therefore, $3.5 + 2.7 \times (1 + 3.2) = 14.8 \mu$ mf.

The r-f grid charging current is now $6.28 \times 56 \times 10^6 \times 14.8 \times 375 = 1.95$ amperes

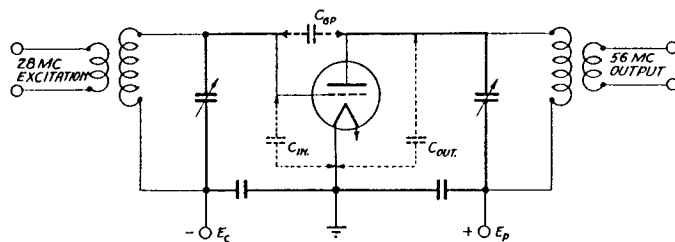

FIG. J3

The RK-37 will have a higher dynamic input capacitance because the voltage gain and hence the transferred capacitance is higher. At the same plate voltage for the RK-37, $X = 1200/260 = 4.62$ and the dynamic input capacitance is $3.5 + 3.2 (1 + 4.62) = 21.5 \mu$ mf., and the peak r-f grid charging current is $6.28 \times 56 \times 10^6 \times 21.5 \times 10^{-12} \times 260 = 1.96$ amp.

The peak r-f grid charging current is, therefore, about the same in this particular case for either the high or the low mu tube. Although the dynamic input capacitance of the high mu tube is higher, the grid driving voltage is low enough to compensate.

By lowering the bias it is possible to operate with a high power and voltage gain. This will increase the dynamic grid capacitance but on the other hand, the lowered grid voltage approximately compensates for the increased capacitance. The existence of this transferred capacitance can be very easily demonstrated. For instance, it is known that in a perfectly neutralized amplifier the plate circuit has no effect on the grid tuning but that in an oscillator the detuning effect of the plate circuit is very prominent, particularly if the tube capacitances are comparable in value to the tuning capacitances.

MODULATED OSCILLATORS If an oscillator is modulated, the r-f plate voltage rises to very high values with large transients. The RK-35 is rated for use as a plate modulated amplifier at a d-c plate voltage of 1250 volts. The peak r-f plate voltage at 100% modulation is $1250 \times 2 \times 0.8 = 2000$ volts. At the peak of the audio cycle the dynamic input capacitance is $3.5 + 2.7 (1 + 2000/365) = 21 \mu$ mf., and the peak r-f grid charging current is $21/14.8 \times 1.95 = 2.77$ amperes.

HARTLEY OSCILLATOR If the oscillator is of the form shown in Fig. J2, the same conditions hold, since during operation the voltage values and phase are the same as in the tuned grid, tuned plate oscillator that has just been discussed.

DOUBLER SERVICE When a tube is operated as a doubler still different conditions are in effect. It might be thought that the r-f charging currents in the grid circuit would not be serious since the grid is operated at one-half the plate circuit frequency. However, this is not the case since the grid circuit, being at doubler frequency, offers negligible impedance to the flow of second harmonic current with the result that the plate voltage drives r-f current through the grid to plate capacitance and then out through the grid lead to ground, as shown in Fig. J3. Thus, if the RK-35 we have been discussing is operated as a doubler from 28 megacycles to 56 megacycles, the peak r-f plate voltage will be on the order of 1200 volts and the r-f (56 megacycle) grid charging current, limited only by the grid to plate capacitance, will be $6.28 \times 56 \times 10^6 \times 2.7 \times 10^{-12} \times 1200 = 1.14$ amperes

The heating effect of this current added to the heating effect of the charging current that is the result of the 28 megacycle excitation will give the total grid lead heating. To keep the r-f grid charging current at low values, it is necessary that the doubler tube have a low grid to plate capacitance. Pentodes, because of their perfect shielding are ideal from this standpoint.

GENERAL It should be remembered that the RK-35 and RK-37, which have been considered in the foregoing discussion, are special tubes with very low interelectrode capacitances. The magnitude of the r-f currents in certain cases has been shown to be several amperes, even for these special tubes. For tubes of the same power rating, but with large interelectrode capacitances, the magnitude of the charging currents may be many times greater than those of the RK-35. If long life is to be expected from such tubes, the ratings must be drastically reduced at the ultra high frequencies. The presence of seal heating necessarily entails an expenditure of power. In an oscillator this shows up

as reduced circuit efficiency, while in an amplifier it shows up as increased driving power and reduced plate circuit efficiency.

At a given frequency, the grid lead loss is independent of the L/C ratio of the grid circuit, provided the peak grid voltage is held constant.

TRANSIT TIME EFFECTS At the low frequencies, the grid driving power has been shown to be entirely a function of the grid voltage and the electrons collected by the control grid. At the high frequencies, the grid driving power is increased by losses in the grid leads due to heavy charging currents. However, at frequencies where the time of flight of the electrons is comparable to the frequency of operation, still another factor adds to the active grid loss. This is generally termed the transit time effect.

For example, suppose a single electron is uniformly accelerated between two points one centimeter apart and at a potential with respect to each other of 100 volts. It will be noted that this voltage and distance is of the same order as is encountered in electron tubes. The time of flight of the electron between the two points will be approximately 3.5 billionths of a second (3.5×10^{-10} sec.). Small as this time may seem, it is the same time required for the completion of one cycle of a 286 megacycle wave and represents almost 0.2 of the time required for a complete cycle of a 56 megacycle wave. In practical tubes, the time of flight is even longer because of space charge effects. Since the time of flight is proportional to the distance and inversely proportional to the voltage, it is obvious that transit time effects can be reduced by the use of close interelectrode spacing and high operating voltages.

Transit time effects have still not been completely analyzed except possibly for the case of negative grid tubes where the element following the grid is at ground potential for r.f. While this can be satisfactorily used to explain the factors involved in the operation of screen grid tubes, it fails to explain the operation of triodes as amplifiers or oscillators where the potential of the plate, i.e., the element following the control grid, is also varying at a radio frequency rate. However, a few effects of transit time can be, qualitatively at least, demonstrated for this type of operation.

One of the effects produced by transit time in tubes is to shift the phase of the r-f grid voltage and current so as to lower the grid impedance. The electron current that flows into the control grid may be thought of as consisting of three components. The first is the usual component which consists of the electrons collected by the control grid. This is the current that has been used to calculate the grid driving power at the lower frequencies. The other two components are due to currents induced in the control grid circuit by electron motion in the vicinity of the grid. One component is the result of current being induced in the grid by the electrons approaching the grid while the other component is the result of electrons receding from the grid toward the plate. At low frequencies the density of the electrons in the grid-cathode space is, over almost the entire cycle of the exciting voltage, the same as the density of the electrons in the grid-plate space and the grid current components due to electron motion practically cancel, since they are almost exactly equal and of opposite phase. However, when the velocity of the electrons becomes comparable to the operating frequency, the electron densities on either side of the grid are different over a proportionately larger part of the cycle, the displacement current components no longer cancel, and a current flows into the control grid which is of such phase as to require additional driving power. This grid loss must be supplied by the driver tube or by the tube itself depending on whether the tube is being used as an amplifier or as an oscillator.

Another effect of transit time is to change the relative phase of the grid voltage and plate current because of the time required for the electrons to travel from the grid to the plate. As a result, the grid and plate voltages are no longer 180° out of phase as they ordinarily are in low frequency operation. Since a complete reversal of phase is necessary for proper feedback in an oscillator, the efficiency of the oscillator is reduced and a frequency is eventually reached where operation becomes impossible. In an amplifier, complete neutralization by conventional methods becomes increasingly difficult because such methods depend also on a 180° phase relationship between the grid and plate voltages.

TANK IMPEDANCE A third factor which often must be considered in reducing the ratings but which can be minimized by proper circuit design is the tank impedance. The parallel, unloaded impedance of an ultra high frequency tuned circuit is usually very low, even after the L/C ratio has been reduced to as small a value as is permitted by the output capacitance of the tube. A typical circuit might, for instance, have a parallel impedance of 5000 ohms. Suppose the optimum load impedance for the tube happened to be 5000 ohms, then the tank circuit itself, without any antenna loading, would be an ideal load for the tube. If power is to be removed from such a tank circuit the transferred resistance will lower the tube load impedance to values less than 5000 ohms and the tube will have to operate into a lower than optimum load impedance with resulting poor efficiency. In addition to the inefficient tube operation, much power is wasted in the tank because the tank impedance is of the same order as the load impedance. Practically, this means that a tube that is rated at approximately 40 milliamperes at 500 volts and is loaded with a 5000 ohm tank will draw very nearly the rated current without any additional load and if the circuit is loaded further by means of an antenna, the plate current will be higher than 40 milliamperes and the plate dissipation will become excessive.

IMPROVING TUBE AND TANK PERFORMANCE There are two ways in which the tube and circuit performance can be improved. One way is to design an improved tuned circuit. This can be done, assuming that the L/C ratio is optimum, by using the best air tuning condenser and insulation that is available and by using an inductance of optimum wire size and form factor.

The performance can also be improved if a tube can be selected that will operate into a lower load impedance. For instance, if a tube is available that will work satisfactorily into a 2500 ohm load, the tank can be loaded to this value with better tank efficiency and better tube efficiency.

LOW LOAD IMPEDANCE TUBES VS. OUTPUT CAPACITANCE This brings up the practical questions as to how the load impedance of a tube can be lowered or what tubes have inherently low load impedance. For instance, if two tubes are used in parallel, the load impedance required is one-half that for a single tube but the output capacitance is doubled so there is little to be gained since the increased circuit capacitance lowers the unloaded impedance of the tuned circuit.

The load impedance of a tube has been shown to be proportional to the d-c resistance of the plate circuit and is equal to approximately 0.4 times the operating plate voltage, divided by the operating plate current. Therefore, a desirable tube is one where the plate current is high compared to the plate voltage or in other words, one that has a low d-c plate resistance as a Class C amplifier, but at the same time has a low output capacitance. A good factor for determining the effectiveness of a tube as regards tube and circuit efficiency at the high frequencies is the product of the output capacitance and the d-c plate resistance under Class C conditions. The smaller this value, the better in general is the tube performance. For example, for the RK-10 as an amplifier, this factor is $C_{out} \times 0.4 E_p / I_p = 4 \times 0.4 \times 450 / 65 = 11.1$ but for a special high frequency tube like the RK-32, the factor is $0.7 \times 0.4 \times 1250 / 100 = 3.5$.

When the tuned circuit is included as a split coil between the grid and the plate, as in many high frequency oscillators, the capacitance in question is the grid to plate capacitance of the tube.

ULTIMATE FREQUENCY VS. ULTIMATE FREQUENCY FOR EFFICIENT OPERATION

The ultimate frequency of operation should be carefully differentiated from the ultimate frequency for efficient operation. The ultimate frequency of operation is the resonant frequency of the tube elements and is limited usually by the shunting capacitance of the tube and the physical dimensions of the smallest external circuit without regard to loading or efficiency of operation.

The ultimate frequency for efficient operation is a function of both the shunting capacitance and loading and is generally very much lower than the ultimate operating frequency.

PUSH-PULL CIRCUITS Push-pull circuits, for instance, divide the shunting capacitance of one tube by a factor of two. With the same external circuit as used with one tube, the ultimate frequency is, therefore, increased 1.4 times the single tube value. However, the ultimate frequency for efficient operation is not increased because the load impedance for push-pull tubes is double that for a single tube and this completely cancels the advantage of reduced output capacitance. Push-pull circuits, however, are usually ideal for other reasons. Their symmetry tends to keep r-f currents where they belong without recourse to heavy bypassing. Also, in a perfectly balanced push-pull circuit there is no fundamental r-f current flowing in either the grid or the plate return leads. This prevents any regeneration or degeneration in these leads and permits them to be somewhat longer than those permissible in a single ended circuit.

In transmitters where seal heating may be serious, the heating in push-pull stages is confined to the plate and grid leads and the filament leads are relatively cool. Since the grid and plate leads of tubes like the RK-32, RK-30 and RK-35-RK-38 series are generally out in the open, they are not only less susceptible to heating but can also be cooled by external radiators much more easily than the filament leads in the stem.

BYPASSING AND GROUNDS Adequate bypassing is often difficult to achieve at the ultra high frequencies because the inductance of the shortest possible lead is often so large that potentials are built up which seriously affect the performance of the tube or circuit. In a screen grid tube, it is especially difficult to satisfactorily bypass the screen grid which often accounts for the poor performance of screen grid tubes at the very high frequencies. If the screen lead is too long there will be appreciable inductive reactance between the screen and its bypass condenser, allowing the screen to vary at an r-f potential with resulting instability. For this reason, the screen by-pass condenser should be tied back to the cathode with the shortest leads possible. In some cases it may be necessary to debase the tube and so gain an inch or so on the screen lead within the tube base.

The bypass condensers themselves can cause much trouble, since many that are used were never intended for operation at the frequencies in question. Very little capacitance is needed for bypassing but it must be all capacitance. Only a very small amount of inductance in a condenser is tolerable.

Bypass condensers with a mica dielectric, one plate of which is tied to the point to be bypassed, the other plate being the chassis itself, are very effective. The plate can be about 1" square and the mica between 0.002 inch thick to 0.004 inch thick. These dimensions will make a condenser of approximately 600 $\mu\mu\text{f}$. and 600 working volts for the 0.002 inch thickness, if the mica is clamped tightly between the plates. For the 0.004 inch thickness, the corresponding values are 300 $\mu\mu\text{f}$. and 1200 working volts.

The bypassing of the cathode, control grid circuit and plate circuit is similarly critical and the same precautions should be taken as for the screen grid circuit.

All bypasses to ground should be returned by the shortest paths to the element of the tube that is at ground potential. This is usually the cathode but in some cases it is the screen grid.

Equipment is best built on a metal chassis or on metal screens attached to a wooden base so as to insure a solid ground. With such construction, grounds can quite often be made directly to the chassis or screen at points comparatively distant from the element of the tube that is at ground potential and still give effective bypassing, even though there may be heavy r-f currents in parts of the chassis or screen. Filaments should be thoroughly bypassed and for frequencies above 56 megacycles, it is most essential that chokes or resonant lines be used in the filament leads so as to feed in the filament current at ground potential.

TUBE MATERIALS

The materials used in a radio tube constitute only one of the several factors that determine the quality and performance of the finished tube. However, this factor is one of the most important. The following paragraphs list the materials available for the major structural parts of the tube and discuss the characteristics that determine the choice of particular materials for each tube design.

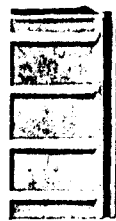

25 Watt Carbonized Nickel Plate RK-11 RK-12

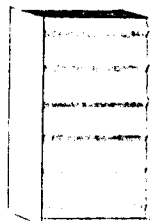

40 Watt Molybdenum Plate RK-18 RK-31

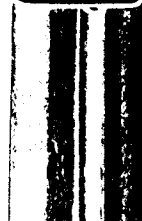

60 Watt Graphite Plate RK-51 RK-52

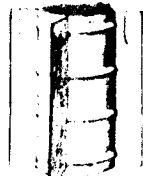

100 Watt Tantalum Plate RK-36 RK-38

PLATES The factors that are important in a plate material are ease of fabrication, mechanical strength, freedom from distortion at high temperatures, heat radiating ability, ease of degassing and freedom from excessive evaporation at temperatures reached during manufacture or operation. The need for good mechanical properties is obvious. It is also obvious that it must be possible to degas the plate during the manufacturing processes to such a degree that no appreciable amount of gas will be given off after the tube has been completed, either on standing or during operation.

The plate must dissipate as heat all the energy developed in it by electron bombardment, and the bulk of this heat must be radiated, for usually only a small fraction is conducted away by the plate supports. The total rate at which heat is radiated depends on the surface area, the characteristic thermal emissivity of the surface and the temperature. In other words, for a given total plate dissipation, the plate assumes a temperature that depends on its surface area and on the heat radiating properties of the plate material. Of course, the location of the supports and the radiating fins affect the uniformity of heat distribution over the plate surface and help to determine the maximum temperature. A relatively large plate running at low temperature will minimize grid emission due to grid wire temperature and electrolysis due to high stem temperature, as well as lessen the evaporation of metal which may deposit where it can cause leakage. On the other hand, a small plate will result in low interelectrode capacitances which are always desirable. In practice the plate size and material has to be chosen so as to give a suitable compromise between these two general requirements and also the cost.

MOLYBDENUM Molybdenum has a long and honorable record as a plate material in transmitting tubes. It has good mechanical properties. It has a very high melting point, 2620°C, and appreciable evaporation begins only at relatively high temperatures, although evaporation in the form of oxide may occur at lower temperatures. Its surface can be cleaned and fairly completely degassed by high temperature treatment. Like most metals, molybdenum is not a good heat radiator when its surface is left bright and smooth, hence molybdenum plates usually have their outer surfaces roughened by sandblasting to increase the heat radiating ability.

Tubes with molybdenum plates are usually rated to operate with the plates showing not more than a dull cherry to light red color, 700° to 850°C, at the hottest spot. Considerably higher temperatures for short periods will not damage the plate itself but, of course, should be avoided because of the danger of overheating other parts of the tube and permanently damaging the tube by the evolution of gas or otherwise. The plate color gives a convenient indication of the plate temperature and may be used to advantage in determining roughly if the tube is operating properly and within its rating for plate dissipation.

TANTALUM In some respects tantalum is almost the ideal plate material. It has good mechanical qualities and a higher melting point, 2850°C, and a higher evaporation point than molybdenum. It can be more completely degassed by high temperature treatment than molybdenum. Another property that is of value is its ability to absorb some gases at a relatively high temperature and thus act as a "getter" for traces of gas given off from other parts of the tube during operation. All of these factors make tantalum particularly suitable for use in ultra high frequency tubes where small plate dimensions are necessary and where it is not desirable to have "getter" deposits on the bulb. Tantalum is by far the most expensive of the plate materials.

Tantalum plates are commonly operated at a yellowish-red or even orange temperature, 900° to 1000°C at the hottest part. The plate itself is not damaged by momentary operation at nearly white heat but such operation should be avoided because it means overheating of the other tube parts. The plate color can be used as an indicator of overload as with molybdenum. High plate temperatures usually mean relatively high grid temperatures and so the grids in tantalum plate tubes must be designed and processed to operate at relatively high temperatures. Likewise, the plate supports run very hot and must be widely spaced from other leads in the glass to avoid conduction and electrolysis in the hot glass.

GRAPHITIZED CARBON In recent years molybdenum has been replaced to some extent by graphite or graphitized carbon as a plate material. Plates of this material are machined out of solid rods. Because of the method of manufacture and greater inherent fragility, as compared to metal, the walls of graphite plates are always much thicker than those of metal plates. There are accompanying advantages such as freedom from warping and good distribution of heat without local hot spots.

Graphitized carbon has a very great absorptive power for gases, which are driven off again when the temperature of the carbon is raised and it is impossible to completely degass it, as additional gas will be given off as the temperature is increased. Long treatment at high temperature is necessary in order to remove the gas sufficiently for use as a power tube plate. Severe overheating of the plate may even then release a damaging quantity of gas. Unless the plate has been properly pretreated there is also danger of loose carbon particles escaping from the plate and damaging the filament. Carbon does not melt or actually evaporate at any temperature that can be reached in a radio tube plate, although it is occasionally deposited on other parts of the tube by the action of gas in the tube during processing.

Carbon has the outstanding advantage of being an almost perfect heat radiator and at a given temperature will radiate several times as much heat per unit area as a bright metal. It is usually operated at about the same watts of heat dissipation per square inch as molybdenum but this corresponds in the graphite plate to a relatively low temperature, 500° to 600°C, at which no color or only a very deep brown-red is visible. For this reason the plate color cannot readily be used as a good indicator of normal plate dissipation. This low operating temperature results in a somewhat lower temperature in the grid which is always desirable and in less heat flow along the plate supports which is also of importance, particularly in tubes where the plate is supported from the stem.

CARBONIZED NICKEL In this material a heavy layer of carbon has been deposited in and on the surface of the nickel base. Carbonized nickel can be shaped into plates in the same way as molybdenum. It has the same heat radiating ability as graphitized carbon and much the same characteristics as regards difficulty of being completely degassed and possibility of loose carbon particles. The melting point of nickel, 1500°C, is the lowest of any of the usual plate materials. This limits the temperature to which it can be raised during processing and the degree to which it can be freed of gas.

Carbonized nickel plates are usually operated at about the same temperature as graphitized carbon plates and have similar operating characteristics except that they do not usually have as good heat distribution and will not stand as much temperature overload without danger of giving off excessive gas.

GLASS BULB AND STEM The heat generated in the tube by the filament and by electron bombardment of the plate and grid is removed from each part by conduction through the stem leads to the stem and by radiation to the bulb. The bulb is very nearly opaque to heat radiation so that energy reaching the bulb from the inner parts is dissipated by re-radiation and by convection and conduction in the surrounding air. The temperature of the bulb rises until it is hot enough to dissipate heat as fast as it is received from the internal parts. The physical size of the bulb is determined largely by the total wattage that is to be developed in the tube. Excessive bulb or stem temperature is avoided because it may cause the evolution of gas from the sur-

face of the glass, which may impair the tube performance or life, or it may result in electrolysis of the glass around the leads and eventual loss of vacuum. In low power tubes the bulb is of the same type of soft glass used in receiving tubes, that is, lime or soda glass. In these tubes the bulb size is relatively large in proportion to the tube wattage.

Higher power tubes are usually made with hard glass, or borate glass, in both stems and bulbs. This is superior to soft glass in that it will stand higher temperatures during the exhaust process without giving off gas, softening or becoming conducting. It is stronger and less liable to strain cracks. Hard glass also causes less dielectric loss when it is subjected to high frequency electric fields, as around the leads.

With hard glass the lead-in wires that are sealed in the stem and bulb are usually of expensive tungsten or molybdenum while with soft glass the same copper-sleeved, nickel steel, lead wires are used as in receiving tubes or in lamps.

GRIDS The grid materials are chosen for good mechanical characteristics, ease of cleaning and degassing, and ability to withstand high temperatures. In low power tubes, the grid side rods are usually of nickel and the mesh wires are generally of molybdenum. The grid wire must be strong and yet soft enough to take the proper shape during the grid winding and stretching operations. It must stand high temperatures during exhaust and operation without distorting or sagging.

In larger power tubes, where the grids may be subjected to higher temperature than nickel will stand, the side rods are also made of molybdenum and tantalum mesh wire is used in some tubes. This is chiefly in ultra high frequency tubes where all the parts are kept small and may run very hot. Tantalum has the same advantages here as it has as a plate material. In addition it has the favorable characteristic of less tendency to emit primary or secondary electrons than molybdenum when used as grid wire.

BASES Outside of mechanical factors, the choice of base material is important principally from the standpoints of leakage, dielectric loss and high voltage insulation. Bakelite is the cheapest material used in amateur tube bases and is satisfactory in low power tubes where the voltage between pins is not more than about 600 volts and where the frequency is not very high or the high frequency leads are not brought through the base.

In other cases and in larger tubes, bases of isolantite or other ceramic is generally used as this type of material will withstand much higher voltages and the dielectric loss is only a fraction of that of ordinary bakelite. It also retains its good insulating and dielectric characteristics at much higher temperatures than ordinary bakelite. Leads to which very high voltages or very high frequencies are applied are usually brought out through the bulb to a separate cap or connector so as to permit much wider separation and consequently better insulation than if brought through the base.

PLATE COLORS OF RAYTHEON AMATEUR TUBES AT RATED DISSIPATION

| Type | Watts Plate Dissipation | Color |
|--------|---|--------------|
| RK-10 | 15 | No Color |
| RK-11 | 25 | No Color |
| RK-12 | 25 | No Color |
| RK-18 | 40 | Light Cherry |
| RK-19 | — | No Color |
| RK-20A | 40 | No Color |
| RK-21 | — | No Color |
| RK-22 | — | No Color |
| RK-23 | 10 | No Color |
| RK-24 | 1.5 | No Color |
| RK-25 | 10 | No Color |
| RK-25B | 10 | No Color |
| RK-28 | 100 | Light Cherry |
| RK-30 | 35 | Dull Cherry |
| RK-31 | 40 | Light Cherry |
| RK-32 | 50 | Orange |
| RK-33 | 2.5 (one plate) | No Color |
| RK-34 | 10 (both plates) | No Color |
| RK-35 | 50 | Lt. Yel. Red |
| RK-36 | 100 | Lt. Yel. Red |
| RK-37 | 100 | Lt. Yel. Red |
| RK-38 | 50 | Lt. Yel. Red |
| RK-39 | 25 | No Color |
| RK-41 | 25 | No Color |
| RK-42 | — | No Color |
| RK-43 | — | No Color |
| RK-44 | 12 | No Color |
| RK-45 | 10 | No Color |
| RK-46 | 40 | No Color |
| RK-47 | 50 | Dull Cherry |
| | at center of plate if viewed in the dark. | |
| RK-48 | 100 | Light Red |
| RK-49 | 21 | No Color |
| RK-51 | 60 | No Color |
| RK-52 | 60 | No Color |
| RK-100 | 15 | No Color |
| 841 | 12 | No Color |
| 842 | 12 | No Color |
| 864 | — | No Color |
| 866 | — | No Color |
| 866A | — | No Color |
| 872A | — | No Color |

For colors and temperature, see color chart next to last page.

RATINGS OF AMATEUR TUBES

At the present time among the manufacturers of amateur tubes there is no standard practice for rating these tubes on a comparative basis and for this reason tubes of approximately the same characteristics are given widely different operating ratings depending on the manufacturer. The following is the rating method used by Raytheon and while it may not be perfect, it is at least consistent and the results obtained are dependable.

A complete group of transmitting tube ratings may be divided into three general parts. The first consists of the fundamental tube characteristics such as the transconductance, amplification factor, plate resistance, and the interelectrode capacitances. The second group consists of the maximum operating ratings and includes such factors as the maximum plate dissipation, maximum space current, maximum plate voltage and maximum r-f grid current. The third group is made up of typical operating conditions.

FUNDAMENTAL AND MAXIMUM OPERATING RATINGS

The fundamental tube characteristics are determined by the physical dimensions and location of the grids, plate and filament and are taken into consideration by the designer in the original design of the tube. The maximum operating ratings are also taken into consideration by the designer in much the following manner.

Let it be supposed that the tube under consideration is to be a 2000 volt, 100 watt plate dissipation triode intended chiefly for use as a Class C amplifier. It is known that most Class C amplifiers operate at approximately 70% efficiency. The permissible power input at this efficiency will be 100/0.3 or 333 watts. At 2000 volts, the plate current will be, therefore, 333/2000 or 167 milliamperes. The current to the control grid will be equal to roughly 25% of this or 42 milliamperes and the total d-c space current will be 167 + 42 or 209 milliamperes. At the assumed efficiency, the ratio of the maximum peak plate current to the d-c plate current is such that, for thoriated tungsten filaments, a figure of 5 milliamperes of d-c space current per watt of heating power may be used to determine the filament power. This is a figure based on expected deterioration of the filament during life and the peak currents to be encountered and is subject to considerable variation. For instance, it will be found that many of the recent tubes, particularly those that are forced to compete with similar types in the amateur market are running nearer to a figure of 7.5 milliamperes per watt of heating power. Heater type cathodes are more efficient emitters and the usual value is about 20 milliamperes/watt. A thoriated tungsten filament will be used in this tube and the filament power required will be, therefore, 209²/5 or approximately 40 watts.

The total internal tube dissipation is the sum of the plate, grid and filament dissipations and assuming that the grid loss is very small compared to the plate loss, the total tube dissipation is 140 watts. The designer can now devise a bulb shape taking into account the bulb material, the total power to be dissipated by the bulb and the temperature distribution within the bulb.

The plate temperature and the plate size have been already determined by the plate dissipation and material. The d-c plate voltage is to be 2000 volts so that the plate will have to be sufficiently well insulated from ground, the grids, and the filament to insure against voltage breakdown, keeping in mind that the plate voltage rises instantaneously to values that approach twice the d-c plate voltage of the tube. If the foregoing factors have been properly taken into account by the designer, the maximum ratings may be used as a basis for obtaining tentative operating ratings for the tube.

MEASUREMENT OF CHARACTERISTICS

The transconductance and amplification factor are usually obtained first. The transconductance varies widely with plate current so that as a standard value, the transconductance in the vicinity of the maximum Class C d-c plate current is obtained under static conditions by shifting the grid bias a small amount and measuring the change in plate current. The transconductance is then the change in plate current divided by the change in grid voltage. The amplification factor is not subject to as much variation as the transconductance and is obtained at the same point by changing the grid voltage a small amount and determining the change in plate voltage necessary to restore the plate current to its original value. The change in plate voltage divided by the change in grid voltage is the amplification factor.

The interelectrode capacitances are measured by bridge methods. They are static capacitances and may be different from the dynamic capacitances in tube operation. The input electrode capacitance is measured between the grid and all other elements; the output electrode capacitance is measured between the plate and all other elements; while the grid to plate capacitance is measured between the grid and the plate with all other elements at ground.

TENTATIVE OPERATING CONDITIONS

Without recourse to measurement or calculation from the characteristic curves, it is usually possible to determine approximately many of the expected operating characteristics. A tentative Class C rating has been used, for instance, to determine the approximate space current in the initial design and, on the basis of 70% efficiency, the power output is 233 watts at a d-c plate current of 167 milliamperes and a d-c plate voltage of 2000 volts.

A Class B r-f rating can be developed assuming operation at 33% carrier efficiency. The Class B carrier input is thus 100/0.67 or 150 watts and the expected power output is 50 watts. The d-c plate current for the carrier condition is 75 milliamperes for a d-c plate voltage of 2000 volts. Grid bias modulation values can be developed in the same manner and should give the same results as Class B R-F as to power output and d-c plate current.

For two tubes a Class B audio rating can be applied assuming 66% efficiency, the power input will be 2 x 100/0.33 or 600 watts, the d-c plate current will be 300 milliamperes (two tubes) and the power output will be 400 watts.

Although many advertised tube ratings are on a theoretical basis, they cannot be relied upon to tell the whole story. For instance, at the assumed d-c plate voltage and current, it may be impossible to swing the plate voltage as low as that required by the assumed efficiency. Driving power can only be assumed and little can be determined as to the magnitude of the distortion that is present in any telephony application. For this reason it is necessary either to calculate the other factors from the characteristic curves or measure them in typical setups. At Raytheon we have chosen the latter method, inasmuch as measurements can be quickly made and the effect of adjustments noted. A large number of tubes can be checked to determine the effect of variations in tube characteristics. Easily variable element voltages permit measurements to be made under widely varying voltage conditions. The procedure used with this system is approximately as follows:—

TYPICAL OPERATING CONDITIONS

CLASS C TELEGRAPHY—PLATE EFFICIENCY

Depending on the plate efficiency, almost any Class C operating conditions are theoretically possible. For example, many tubes can stand plate voltages much in excess of the value indicated by the plate current and plate dissipation at average efficiencies. It is, therefore, possible to have high efficiency Class C operating conditions without exceeding the maximum tube ratings. For instance, for the tube in question, the power output at 70% efficiency is 233 watts, see Fig. E1, but if the efficiency is raised to 75% the possible power input is 100/0.25 or 400 watts and the power output is 300 watts. Thus, by a 5% increase in efficiency, the power output has been increased by 63 watts or about 27%. At an efficiency of 80%, the power input is 500 watts and the power output is 400 watts or an increase of 163 watts over the original 70% efficiency figure. However, if the rated d-c plate current is not to be exceeded at 75% efficiency, the d-c plate voltage required is 400/0.167 or 2400 volts and at 80% efficiency the d-c plate voltage is 500/0.167 or 3000 volts.

Since operation takes place with a high plate voltage and relatively low plate current, the load impedance is high which in turn requires a very good tank circuit, if the ratio of the power lost in the tank circuit to that dissipated in the load is to be maintained small. The grid bias must be increased, which results in increased driving power, as shown for an RK-38 in Fig. E2. Since the ratio of the peak current to the d-c current increases, the emitter also must be able to supply the peak space current demands. An important fact to remember is that Class C plate efficiency is not entirely tied up with the tube. It is more a function of the circuit voltages and currents.

We have selected efficiencies in the order of 70% as a compromise between power output, power gain and tank circuit efficiency. That this is a reasonable figure is borne out by the fact that most amateur transmitters operate at approximately 70% Class C efficiency. If a tube has adequate emission and is capable of withstanding the increased plate voltage, well and good, the tube legitimately can be advertised as such but it should be remembered that the improvement in efficiency required to obtain a high ratio of power output to plate dissipation is sometimes difficult to obtain and a less expensive tube that cannot be expected to stand the increased plate voltage may be more satisfactory in the long run when all other factors have been duly considered.

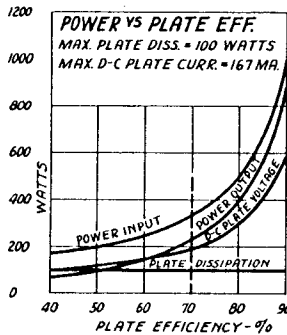

FIG. E1

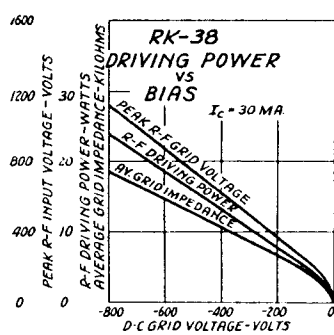

FIG. E2

CLASS C TELEGRAPHY—DRIVING POWER

Another factor that is subject to considerable variation in operating a tube is the grid driving power. For linear plate modulation it has long been customary to bias the tube to double the cutoff value. Such values of bias result in relatively high values of driving power. The tube will usually operate at much lower bias values without a very great loss in efficiency, although the linearity of the plate voltage vs. output current relationship will suffer as a consequence. This is unimportant for CW operation so that operation may be obtained at low bias values with excitation requirements that are very much less than those for telephony.

Most Class C telegraphy ratings have been tinged by phone operation and are usually at double cutoff and through custom have been set at this value although smaller biases will often work satisfactorily, particularly with low μ tubes and with less driving power. Dropping the bias for telegraphy, therefore, greatly improves the power gain without seriously affecting the output power and before two tubes of comparable amplification factors are to be compared for driving power they should be compared at some standard value of bias and the one most commonly used is the double cutoff value.

To rate a tube for Class C telegraphy the bias is, therefore, set at double the cutoff value and the excitation and loading adjusted until the tube is operating at approximately 70% efficiency and as nearly as possible at rated plate current and dissipation. If the tube has been properly designed as to plate voltage and space current, at 70% efficiency, the plate current will be very close to the permissible maximum. Grid driving power and the peak r-f grid voltage are measured by methods that have been described under "Grid Driving Power and the Exciter".

CLASS C TELEPHONY

To rate a tube for Class C telephony, it is necessary to reduce the d-c plate voltage since at the positive modulation peaks the instantaneous plate voltage is twice the carrier value. Rigorously, the carrier plate voltage for telephony should be but 50% of the telegraphy plate voltage; actually the usual reduction is about 25%. The maximum carrier plate dissipation for telephony is 2/3 of the telegraphy rating since under modulation the plate dissipation rises by 50%. Although it is impossible to obtain exactly linear modulation with a fixed grid bias, actually, at biases of double cutoff or greater the modulation is quite linear. The bias is, therefore, fixed at two and one-half times cutoff where the loading and excitation are adjusted not only to give rated telephony plate dissipation at approximately 70% efficiency but also to insure linearity of modulation. To check this linearity, either the plate voltage is increased step by step and plotted against power output over the range from zero to twice the carrier value or a sinusoidal modulating voltage is applied to the plate and the modulated output viewed on a cathode ray oscillograph. A maximum total distortion of 5% is considered permissible.

CLASS C TELEPHONY—GRID BIAS MODULATION AND CLASS B R-F

Grid bias modulation and Class B R-F operating conditions are somewhat more difficult to decide upon because of the number of variables that are involved. The procedure that we have adopted is to tolerate a maximum permissible distortion of 10% and then from a series of curves determine the maximum power output without exceeding the permissible plate dissipation or distortion. For grid bias modulation the grid bias is set at a value somewhat greater than cutoff and the circuit adjusted for maximum output. The grid bias is then increased in steps and the output plotted. This is done for several values of the initial bias point and the optimum curve finally selected. Class B linear amplifiers are rated in the same manner but in this case the excitation is varied while the grid bias remains constant at several values at or less than cutoff. Driving power and modulating power are calculated by methods described under "Driving Power and the Exciter" and "Modulation". Class B audio ratings are made in a similar manner to the Class B R-F ratings except, of course, that two tubes are used.

OPERATION UNDER OTHER CONDITIONS

The typical operating conditions that are obtained by the foregoing methods are not the only conditions under which tube operation can take place. They simply represent one set of conditions under which it is known that the tube will operate satisfactorily. Variations in these conditions are permissible provided no one maximum rating is exceeded.

LIFE TESTS

Although all of the required ratings can be tentatively developed by these methods, the job of rating the tube cannot be considered complete until exhaustive life tests have been made under the expected operating conditions. Only when a number of tubes have successfully passed such life tests can the tube rating be called complete.

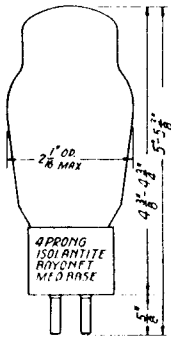

**TRIODE
POWER AMPLIFIER
OSCILLATOR**

The RK-10 is a triode type power amplifier tube having a thoriated tungsten filament and an isolantite base. It is designed for use as an amplifier, oscillator or frequency multiplier.

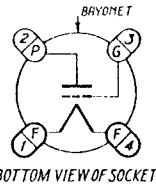

FILAMENT RATING

| | | |
|------------------|------|-------|
| Filament Voltage | 7.5 | volts |
| Filament Current | 1.25 | amp |

DIRECT INTERELECTRODE CAPACITANCES

| | | |
|---------------|---|---------------|
| Grid to Plate | 8 | μf |
| Input | 3 | μf |
| Output | 4 | μf |

A-F POWER AMPLIFIER—CLASS A

MAXIMUM RATINGS

| | | |
|-------------------|-----|-------|
| D-C Plate Voltage | 425 | volts |
| Plate Dissipation | 12 | watts |

TYPICAL OPERATION

| | | | | |
|----------------------|--------|-------|-------|------------------|
| D-C Plate Voltage | 250 | 350 | 425 | volts |
| D-C Grid Voltage | -23.5† | -32 † | -40 † | volts |
| D-C Plate Current | 10 | 16 | 18 | ma |
| Amplification Factor | 8 | 8 | 8 | |
| Plate Resistance | 6000 | 5150 | 5000 | ohms |
| Transconductance | 1330 | 1550 | 1600 | μmhos |
| Load Resistance | 13000 | 11000 | 10200 | ohms |
| Power Output | 0.4 | 0.9 | 1.6 | watts |

R-F POWER AMPLIFIER OR OSCILLATOR—CLASS C

MAXIMUM RATINGS

| | | |
|------------------------------|-----|-------|
| D-C Plate Voltage—Telegraphy | 450 | volts |
| D-C Plate Voltage—Telephony | 450 | volts |
| With Grid Modulation | 350 | volts |
| With Plate Modulation | 350 | volts |
| D-C Plate Current | 65 | ma |
| D-C Grid Current | 15 | ma |
| R-F Grid Current | 5 | amp |
| Plate Dissipation | 15 | watts |

†Grid Voltage measured from mid-point of a-c operated filament.

TYPICAL OPERATION

| | Telephony Grid Modulation | Telephony Plate Modulation | Telegraphy | |
|------------------------|---------------------------|----------------------------|------------|-------|
| D-C Plate Voltage | 450 | 350 | 450 | volts |
| D-C Grid Voltage | -170 | -100 | -100 | volts |
| D-C Plate Current | 40 | 50 | 65 | ma |
| D-C Grid Current | 1 | 12 | 15 | ma |
| Peak R-F Input Voltage | 240 | 200 | 235 | volts |
| R-F Driving Power | 2.4* | 2.2 | 3.2 | watts |
| Carrier Power Output | 6 | 12 | 19 | watts |
| Peak A-F Voltage—Plate | — | 350* | — | volts |
| Peak A-F Voltage—Grid | 70 * | — | — | volts |
| A-F Modulating Power | 0.7* | 9 | — | watts |
| Peak Power Output | 24 * | 48 * | — | watts |

R-F POWER AMPLIFIER—CLASS B—TELEPHONY

MAXIMUM RATINGS

| | | |
|-----------------------------|-----|-------|
| D-C Plate Voltage | 450 | volts |
| D-C Plate Current (Carrier) | 40 | ma |
| Plate Dissipation (Carrier) | 12 | watts |

TYPICAL OPERATION

| | | |
|------------------------|-------|-------|
| D-C Plate Voltage | 450 | volts |
| D-C Grid Voltage | -60 | volts |
| D-C Plate Current | 40 | ma |
| D-C Grid Current | 1.5 | ma |
| Peak R-F Input Voltage | 200* | volts |
| R-F Driving Power | 4.1 * | watts |
| Carrier Power Output | 6 | watts |
| Peak Power Output | 24 * | watts |

*At the peak of the a-f cycle with 100% modulation.

OPERATING NOTES

FREQUENCY RANGE

The RK-10 may be operated at the maximum ratings at frequencies up to 60 megacycles. Above 60 megacycles the reduced efficiency realized requires that the plate voltage be lowered to prevent the plate dissipation from exceeding the maximum rated value.

BIAS

At least 40 volts of fixed bias should be used with 450 volts on the plate to protect the tube in case of failure of the bias or excitation. Additional bias may be obtained by the use of a grid or cathode resistor.

PLATE TEMPERATURE

The plate of the RK-10 will not show color when operated at the maximum rated plate dissipation. Dissipations above the rated value should be avoided.

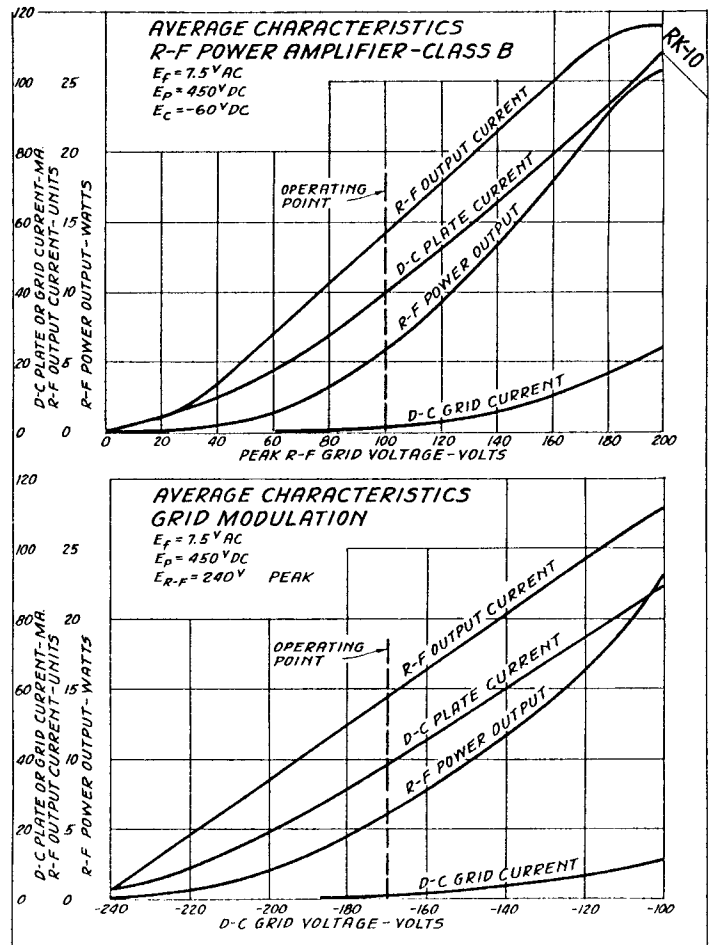
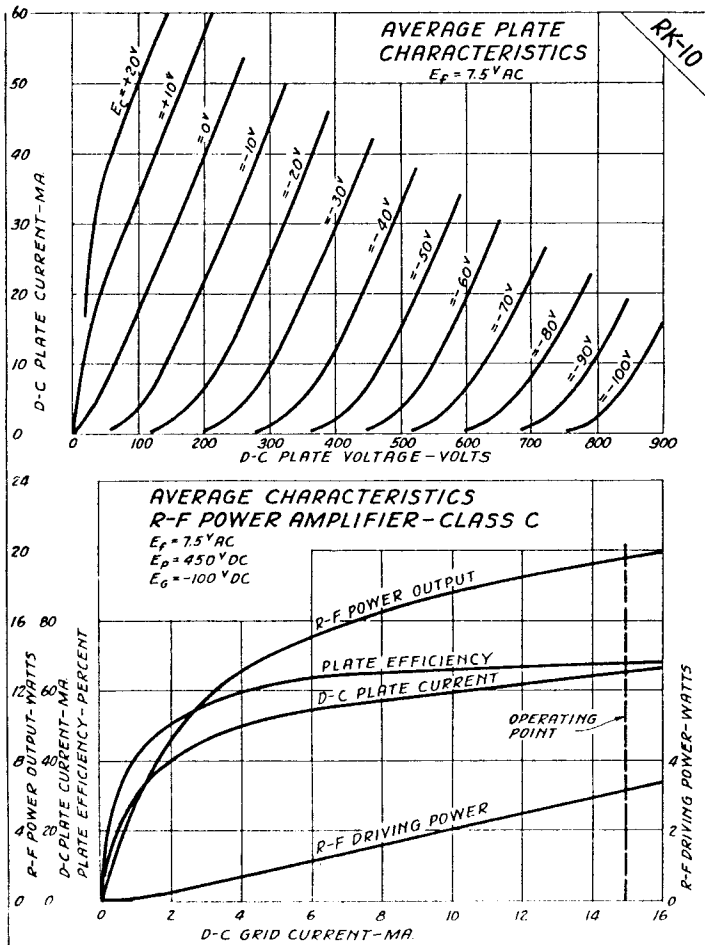

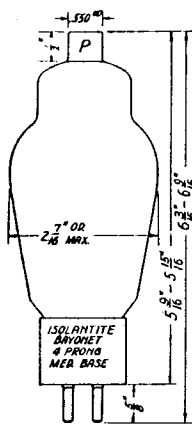

**TRIODE
POWER AMPLIFIER
OSCILLATOR**

The RK-11 is a triode type power amplifier tube having a thoriated tungsten filament, and an isolantite base. It is designed for use as a power amplifier, oscillator or frequency multiplier.

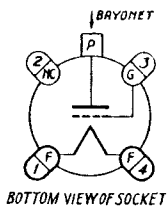

BOTTOM VIEW OF SOCKET

**AMPLIFICATION FACTOR 20
FILAMENT RATING**

Filament Voltage 6.3 volts
Filament Current 3.0 amp

DIRECT INTERELECTRODE CAPACITANCES

Grid to Plate 7 $\mu\mu\text{f}$
Input 7 $\mu\mu\text{f}$
Output 0.9 $\mu\mu\text{f}$

**R-F POWER AMPLIFIER OR OSCILLATOR—
CLASS C—TELEGRAPHY**

MAXIMUM RATINGS
D-C Plate Voltage 750 volts
D-C Plate Current 105 ma
D-C Grid Current 35 ma
Plate Dissipation 25 watts

TYPICAL OPERATION

D-C Plate Voltage 500 750 volts
D-C Grid Voltage -100 -120 volts
D-C Plate Current 100 105 ma
D-C Grid Current 21 21 ma
Peak R-F Input Voltage 165 170 volts
R-F Driving Power 3.1 3.2 watts
Power Output 35 55 watts

R-F POWER AMPLIFIER—CLASS B—TELEPHONY

MAXIMUM RATINGS

D-C Plate Voltage 750 volts
D-C Plate Current (Carrier) 50 ma
Plate Dissipation (Carrier) 25 watts

TYPICAL OPERATION

D-C Plate Voltage 750 volts
D-C Grid Voltage -40 volts
D-C Plate Current 44 ma
D-C Grid Current 1 ma
Peak R-F Input Voltage 110* volts
R-F Driving Power 2 * watts
Carrier Power Output 12 watts
Peak Power Output 48 * watts
*At the peak of the a-f cycle with 100% modulation.

R-F POWER AMPLIFIER—CLASS C—TELEPHONY

MAXIMUM RATINGS

| | Plate Modulation | Grid Modulation | |
|-----------------------------|------------------|-----------------|-------|
| D-C Plate Voltage | 600 | 750 | volts |
| D-C Plate Current (Carrier) | 83 | 50 | ma |
| D-C Grid Current (Carrier) | 35 | 5 | ma |
| Plate Dissipation (Carrier) | 17 | 25 | watts |

TYPICAL OPERATION

| | Plate Modulation | Grid Modulation | |
|-----------------------------|------------------|-----------------|-------|
| D-C Plate Voltage | 500 600 | 750 | volts |
| D-C Grid Voltage | -100 -120 | -130 | volts |
| D-C Plate Current | 83 85 | 38 | ma |
| D-C Grid Current | 26 24 | 1.2 | ma |
| Peak R-F Input Voltage | 160 170 | 150 | volts |
| R-F Driving Power | 3.7 3.7 | 2.7* | watts |
| Carrier Power Output | 28 38 | 12 | watts |
| Peak A-F Modulating Voltage | 500* 600* | 30* | volts |
| A-F Modulating Power | 21 26 | 0.5* | watts |
| Peak Power Output | 112* 152* | 48* | watts |

*At the peak of the a-f cycle with 100% modulation.

OPERATING NOTES

FREQUENCY RANGE

The construction of the RK-11 allows operation at the maximum ratings at frequencies up to 60 megacycles. Above 60 megacycles the reduced efficiency realized requires that the plate voltage be lowered to prevent the plate dissipation from exceeding the maximum rated value.

BIAS

A fixed bias voltage of at least 30 volts should be used with a plate voltage of 750 volts in order to protect the tube in case of failure of bias or excitation. The fixed bias may be reduced with lower plate voltage.

PLATE TEMPERATURE

The plate of the RK-11 will not show color when operated at the maximum rated plate dissipation. Dissipations above the rated value should be avoided.

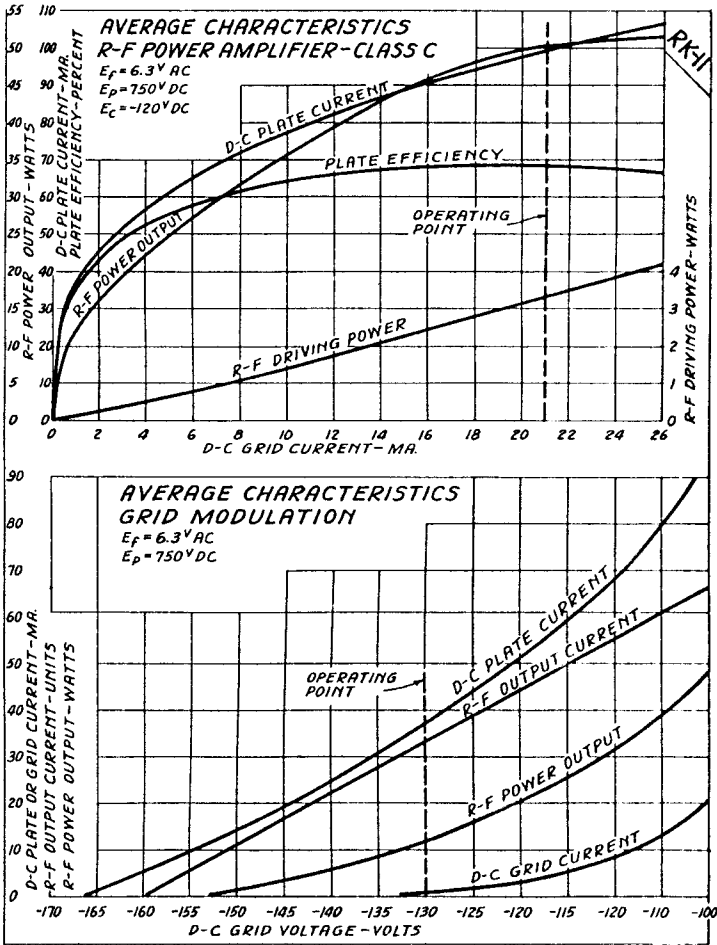
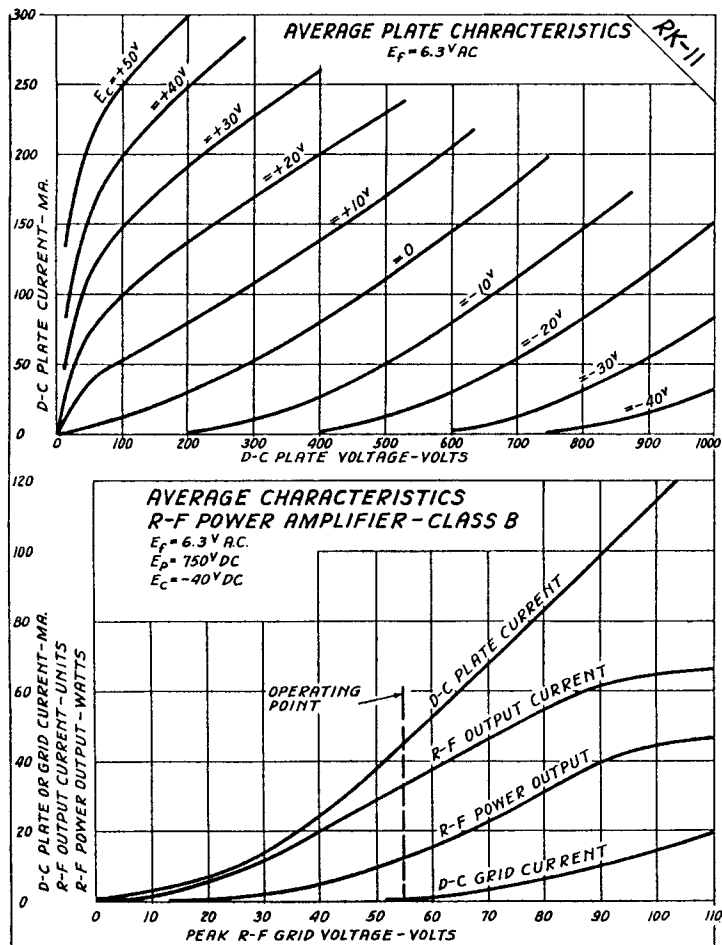

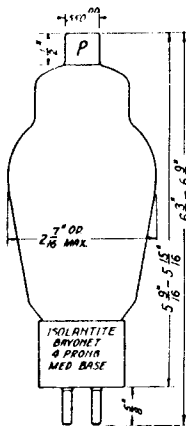

TRIODE POWER AMPLIFIER OSCILLATOR

The RK-12 is a high-mu triode type power amplifier tube having a thoriated tungsten filament and an isolantite base. It is designed for use as a power amplifier, oscillator or frequency multiplier.

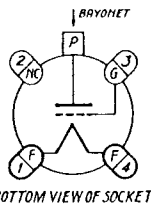

BOTTOM VIEW OF SOCKET

FILAMENT RATING

| | | |
|------------------|-----|-------|
| Filament Voltage | 6.3 | volts |
| Filament Current | 3.0 | amp |

DIRECT INTERELECTRODE CAPACITANCES

| | | |
|---------------|-----|---------------|
| Grid to Plate | 7 | μf |
| Input | 7 | μf |
| Output | 0.9 | μf |

A-F POWER AMPLIFIER—CLASS B—TWO TUBES

MAXIMUM RATINGS

| | | |
|------------------------------|-----|-------|
| D-C Plate Voltage | 750 | volts |
| D-C Plate Current (per tube) | 105 | ma |
| Plate Dissipation (per tube) | 25 | watts |

(Averaged over 1 cycle)

TYPICAL OPERATION

| | | |
|--------------------------------------|------|-------|
| D-C Plate Voltage | 750 | volts |
| D-C Grid Voltage | 0 | volts |
| D-C Plate Current (no signal) | 50 | ma |
| D-C Plate Current (max. signal) | 200 | ma |
| D-C Grid Current (max. signal) | 65 | ma |
| Peak A-F Grid Voltage (grid to grid) | 129 | volts |
| A-F Driving Power | 3.4 | watts |
| Load Resistance (plate to plate) | 9600 | ohms |
| Power Output | 100 | watts |

R-F POWER AMPLIFIER—CLASS C—TELEGRAPHY

MAXIMUM RATINGS

| | | |
|-------------------|-----|-------|
| D-C Plate Voltage | 750 | volts |
| D-C Plate Current | 105 | ma |
| D-C Grid Current | 40 | ma |
| Plate Dissipation | 25 | watts |

TYPICAL OPERATION

| | | | |
|------------------------|------|------|-------|
| D-C Plate Voltage | 500 | 750 | volts |
| D-C Grid Voltage | -100 | -100 | volts |
| D-C Plate Current | 100 | 105 | ma |
| D-C Grid Current | 32 | 35 | ma |
| Peak R-F Input Voltage | 160 | 165 | volts |
| R-F Driving Power | 4.6 | 5.2 | watts |
| Power Output | 35 | 55 | watts |

R-F POWER AMPLIFIER—CLASS C—TELEPHONY

PLATE MODULATION

MAXIMUM RATINGS

| | | |
|-------------------|-----|-------|
| D-C Plate Voltage | 600 | volts |
| D-C Plate Current | 85 | ma |
| D-C Grid Current | 40 | ma |
| Plate Dissipation | 17 | watts |

TYPICAL OPERATION

| | | | |
|------------------------|------|------|-------|
| D-C Plate Voltage | 500 | 600 | volts |
| D-C Grid Voltage | -100 | -100 | volts |
| D-C Plate Current | 85 | 85 | ma |
| D-C Grid Current | 27 | 27 | ma |
| Peak R-F Input Voltage | 148 | 155 | volts |
| R-F Driving Power | 3.6 | 3.8 | watts |
| Carrier Power Output | 30 | 38 | watts |
| A-F Modulating Power | 21 | 26 | watts |
| Peak Power Output | 120 | 152 | watts |

OPERATING NOTES

FREQUENCY RANGE

The construction of the RK-12 allows operation at the maximum ratings at frequencies up to 60 megacycles. Above 60 megacycles reduced efficiency requires that the plate voltage be lowered to prevent the plate dissipation from exceeding the maximum rated value.

PLATE TEMPERATURE

The plate of the RK-12 will not show color when operated at the rated plate dissipation. Dissipations above the rated value should be avoided.

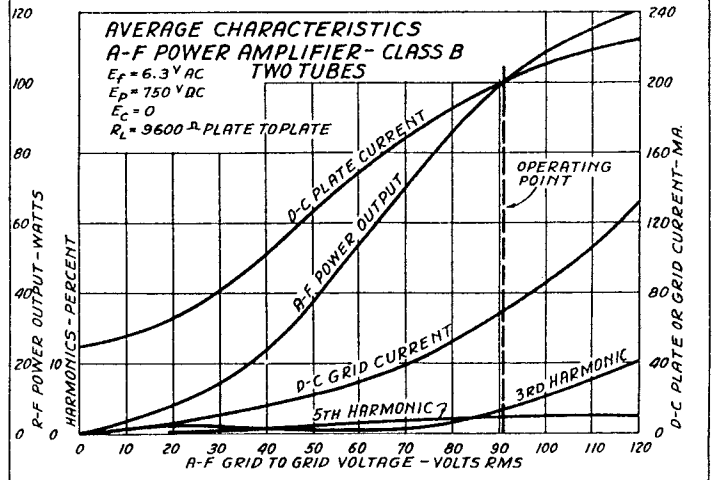
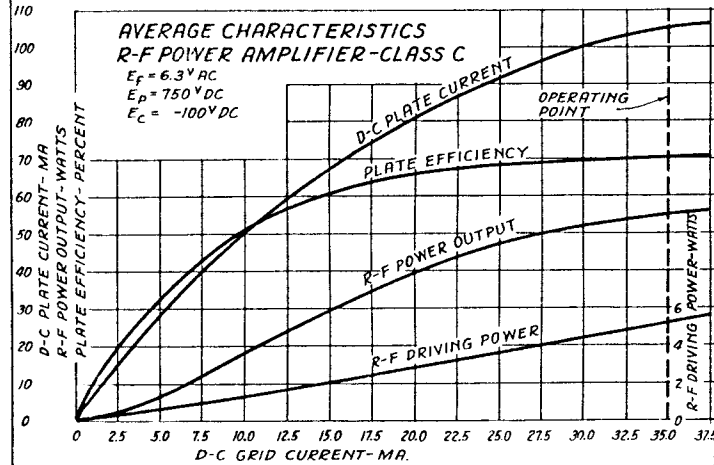
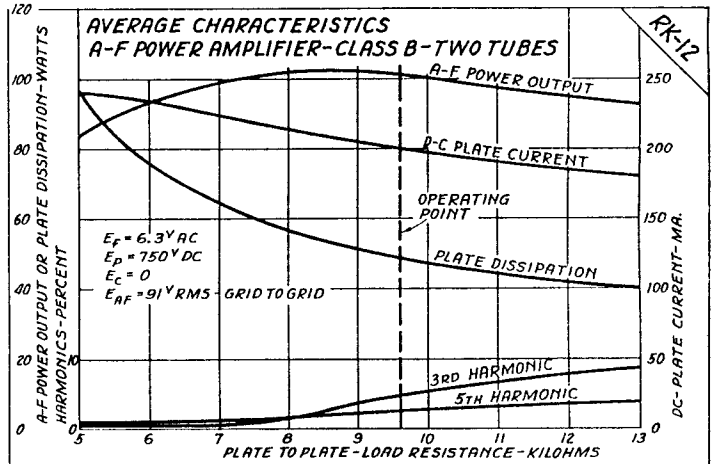
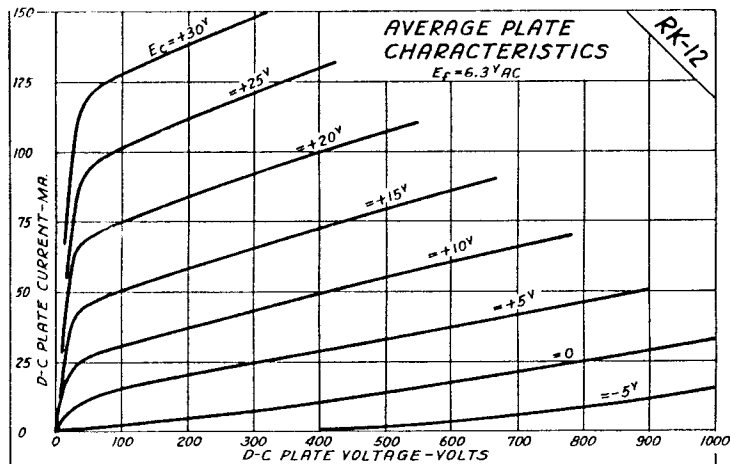

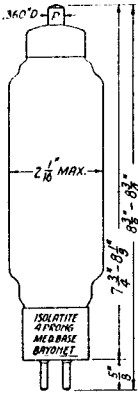

TRIODE POWER AMPLIFIER OSCILLATOR

The RK-18 is a triode type power amplifier tube having a thoriated tungsten filament, a molybdenum plate and an isolantite base. It is designed for use as a power amplifier, oscillator or frequency multiplier.

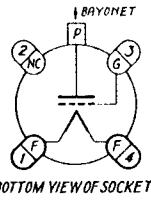

BOTTOM VIEW OF SOCKET

FILAMENT RATING

| | | |
|------------------|-----|-------|
| Filament Voltage | 7.5 | volts |
| Filament Current | 3 | amp |

DIRECT INTERELECTRODE CAPACITANCES

| | | |
|---------------|-----|---------------|
| Grid to Plate | 4.8 | μf |
| Input | 6 | μf |
| Output | 1.8 | μf |

R-F POWER AMPLIFIER OR OSCILLATOR—CLASS C

MAXIMUM RATINGS

| | | |
|------------------------------|------|-------|
| D-C Plate Voltage—Telegraphy | 1250 | volts |
| D-C Plate Voltage—Telephony | 1250 | volts |
| With Grid Modulation | 1000 | volts |
| With Plate Modulation | 100 | ma |
| D-C Plate Current | 40 | ma |
| D-C Grid Current | 5 | amp |
| R-F Grid Current | 40 | watts |
| Plate Dissipation | | |

TYPICAL OPERATION

| | Telephony Grid Modulation | Telephony Plate Modulation | Telegraphy | |
|------------------------|---------------------------|----------------------------|------------|-------|
| D-C Plate Voltage | 1250 | 1000 | 1250 | volts |
| D-C Grid Voltage | -140 | -160 | -160 | volts |
| D-C Plate Current | 38 | 80 | 100 | ma |
| D-C Grid Current | 0.5 | 13 | 12 | ma |
| Peak R-F Input Voltage | 150 | 265 | 255 | volts |
| R-F Driving Power | 3.8* | 3.1 | 2.8 | watts |
| Carrier Power Output | 18 | 64 | 95 | watts |
| Peak A-F Voltage—Plate | — | 1000* | — | volts |
| Peak A-F Voltage—Grid | 60* | — | — | volts |
| A-F Modulating Power | 1.5* | 40 | — | watts |
| Peak Power Output | 72* | 256* | — | watts |

*At the peak of the a-f cycle with 100% modulation.

R-F POWER AMPLIFIER—CLASS B—TELEPHONY

MAXIMUM RATINGS

| | | |
|-----------------------------|------|-------|
| D-C Plate Voltage | 1250 | volts |
| D-C Plate Current (Carrier) | 50 | ma |
| Plate Dissipation (Carrier) | 40 | watts |

TYPICAL OPERATION

| | | |
|------------------------|------|-------|
| D-C Plate Voltage | 1250 | volts |
| D-C Grid Voltage | -70 | volts |
| D-C Plate Current | 40 | ma |
| Peak R-F Input Voltage | 160* | volts |
| R-F Driving Power | 2.1* | watts |
| Carrier Power Output | 18 | watts |
| Peak Power Output | 72* | watts |

A-F POWER AMPLIFIER—CLASS B—TWO TUBES

MAXIMUM RATINGS

| | | |
|------------------------------|------|-------|
| D-C Plate Voltage | 1250 | volts |
| D-C Plate Current (per tube) | 115 | ma |
| Plate Dissipation (per tube) | 40 | watts |

TYPICAL OPERATION

| | | | |
|---------------------------------------|-------|-------|-------|
| D-C Plate Voltage | 1000 | 1250 | volts |
| D-C Grid Voltage | -45 | -60 | volts |
| D-C Plate Current (no signal) | 35 | 35 | ma |
| D-C Plate Current (max. signal) | 230 | 220 | ma |
| D-C Grid Current (max. signal) | 38 | 60 | ma |
| Peak A-F Input Voltage (grid to grid) | 268 | 352 | volts |
| A-F Driving Power | 4.3 | 9 | watts |
| Load Resistance (plate to plate) | 12000 | 18000 | ohms |
| Power Output | 150 | 190 | watts |

*At the peak of the a-f cycle with 100% modulation.

OPERATING NOTES

FREQUENCY RANGE

The RK-18 may be operated at the maximum ratings at frequencies up to 60 megacycles. Above 60 megacycles, the reduced efficiency realized requires that the plate voltage be lowered to prevent the plate dissipation from exceeding the maximum rated value.

BIAS

At least 60 volts of fixed bias should be used with 1250 volts on the plate to protect the tube in case of failure of the bias or excitation.

PLATE TEMPERATURE

The RK-18 will show a light cherry color (See Plate Temperature Color Scale) when operated at the maximum rated plate dissipation. Dissipations above the rated value should be avoided.

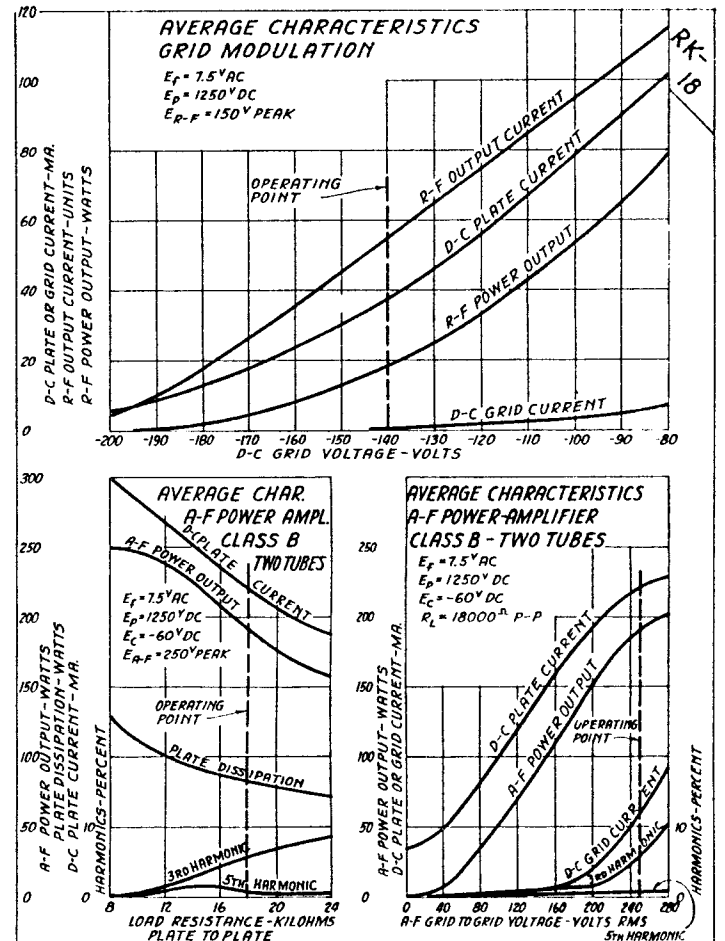
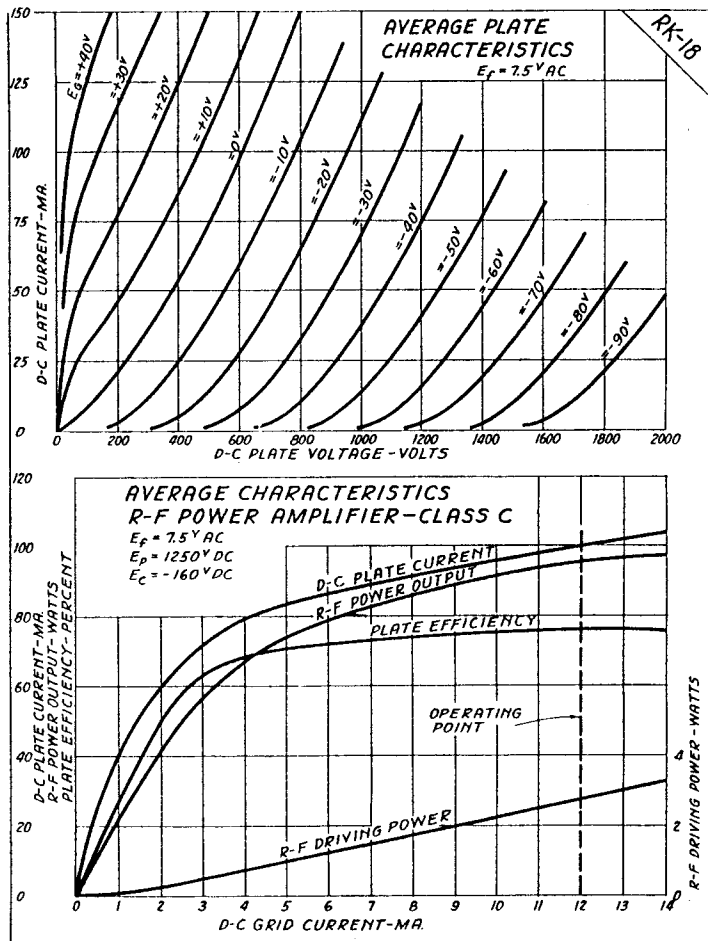

**TWIN DIODE
FULL-WAVE HIGH VACUUM RECTIFIER**

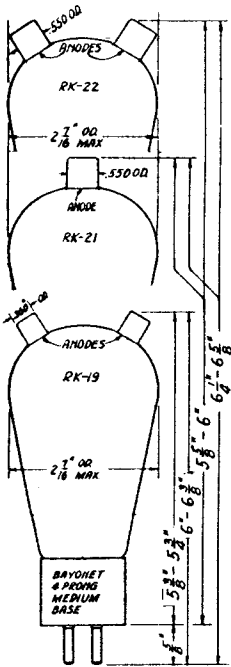

The RK-19 is a heater type full-wave high vacuum rectifier tube designed for use in d-c power supplies delivering approximately 1000 volts d.c. The RK-19 has a low internal voltage drop approaching that of mercury vapor type tubes and operates without generating the r-f noise common to mercury vapor tubes.

HEATER RATING

| | | |
|----------------------|-----|-------|
| Heater Voltage | 7.5 | volts |
| Heater Current | 2.5 | amp |

MAXIMUM RATINGS

| | | |
|------------------------------------|------|-------|
| A-C Voltage per Plate | 1250 | volts |
| Peak Inverse Voltage | 3500 | volts |
| Peak Plate Current per Plate | 0.6 | amp |
| D-C Output Current | 0.2 | amp |
| (Condenser input filter) | | |

OPERATING NOTES

CAUTION

The cathode should always be allowed to reach operating temperature before the plate voltage is applied. For average conditions this delay should be at least 30 seconds.

The plate leads from the power transformer should be of flexible wire to prevent strain on the top caps. Connection to the top caps should be made with a clip or spring clamp. The lead wires must not be soldered to the top caps.

**TWIN DIODE
FULL-WAVE HIGH VACUUM RECTIFIER**

The RK-22 is a heater type full-wave high vacuum rectifier tube designed for use in d-c power supplies delivering approximately 1000 volts d.c. The RK-22 has a low internal voltage drop approaching that of mercury vapor type tubes and operates without generating the r-f noise common to mercury vapor tubes.

HEATER RATING

| | | |
|----------------------|-----|-------|
| Heater Voltage | 2.5 | volts |
| Heater Current | 8 | amp |

MAXIMUM RATINGS

| | | |
|------------------------------------|------|-------|
| A-C Voltage per Plate | 1250 | volts |
| Peak Inverse Voltage | 3500 | volts |
| Peak Plate Current per Plate | 0.6 | amp |
| D-C Output Current | 0.2 | amp |
| (Condenser input filter) | | |

OPERATING NOTES

CAUTION

The cathode should always be allowed to reach operating temperature before the plate voltage is applied. For average conditions this delay should be at least 30 seconds.

The plate leads from the power transformer should be of flexible wire to prevent strain on the top caps. Connection to the top caps should be made with a clip or spring clamp. The lead wires must not be soldered to the top caps.

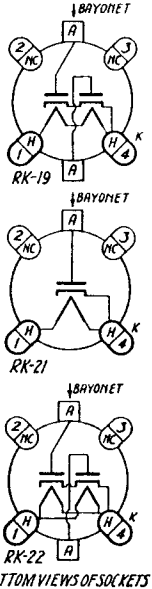

BOTTOM VIEWS OF SOCKETS

**RK-21
DIODE
HALF-WAVE HIGH VACUUM RECTIFIER**

The RK-21 is a heater type half-wave high vacuum rectifier tube designed for use in d-c power supplies delivering approximately 1000 volts d.c. The RK-21 has a low internal voltage drop approaching that of mercury vapor tubes and operates without generating the r-f noise common to mercury vapor tubes.

HEATER RATING

| | | |
|----------------------|-----|-------|
| Heater Voltage | 2.5 | volts |
| Heater Current | 4 | amp |

MAXIMUM RATINGS

| | | |
|---|------|-------|
| A-C Voltage per Plate | 1250 | volts |
| Peak Inverse Voltage | 3500 | volts |
| Peak Plate Current | 0.6 | amp |
| D-C Output Current (condenser input filter) | 0.2 | amp |

OPERATING NOTES

CAUTION

The cathode should always be allowed to reach operating temperature before the plate voltage is applied. For average conditions this delay should be at least 30 seconds.

The plate lead from the power transformer should be of flexible wire to prevent strain on the top cap. Connection to the top cap should be made with a clip or spring clamp. The lead wire must not be soldered to the top cap.

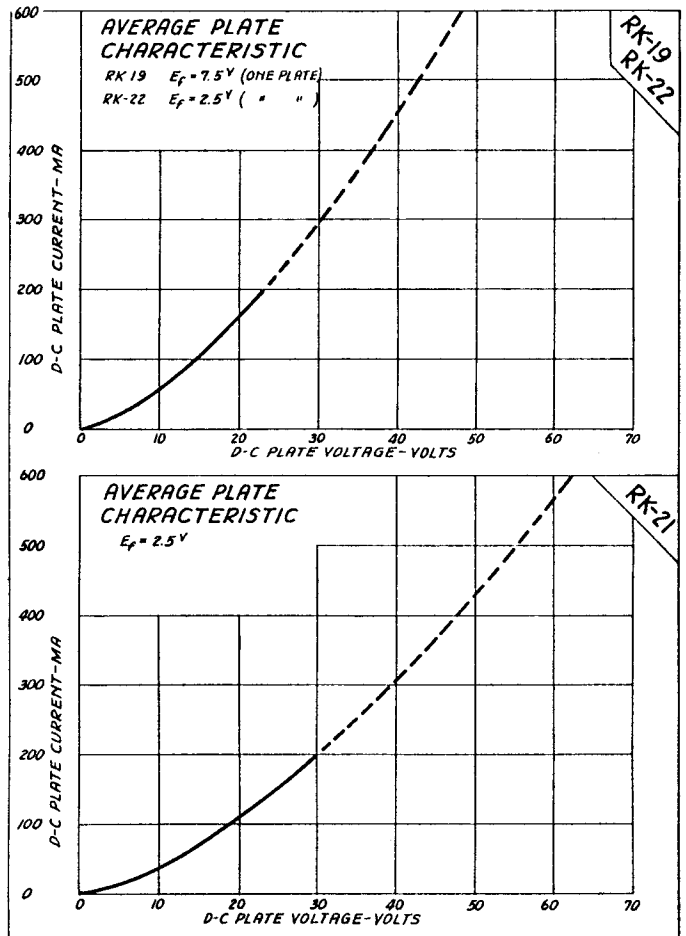

**PENTODE
POWER AMPLIFIER
OSCILLATOR**

The RK-20A is a pentode type power amplifier tube having a thoriated tungsten filament, a molybdenum plate, a hard glass bulb and an isolantite base. It is designed for use as a power amplifier, oscillator or frequency multiplier. The RK-20A may also be used in circuits employing suppressor or control grid modulation.

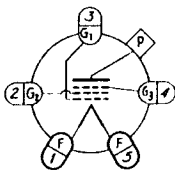

BOTTOM VIEW OF SOCKET

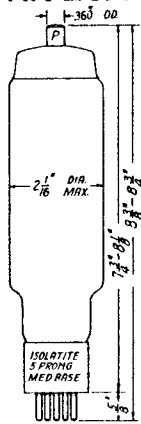

FILAMENT RATING

| | | |
|------------------|------|-------|
| Filament Voltage | 7.5 | volts |
| Filament Current | 3.25 | amp |

DIRECT INTERELECTRODE CAPACITANCES

| | | |
|---------------|------|------------------|
| Grid to Plate | 0.01 | $\mu\mu\text{f}$ |
| Input | 14 | $\mu\mu\text{f}$ |
| Output | 12 | $\mu\mu\text{f}$ |

R-F POWER AMP. OR OSC.—CLASS C

| | | |
|-----------------------------|------|-------|
| MAXIMUM RATINGS | | |
| D-C Plate Voltage—Telephony | 1250 | volts |

| | | |
|--------------------------------------|------|-------|
| D-C Plate Voltage—Telephony | 1250 | volts |
| With Control or Sup. Grid Modulation | 1000 | volts |
| With Plate & Screen Modulation | 300 | volts |
| D-C Screen Voltage | 300 | volts |
| D-C Plate Current | 92 | ma |
| D-C Control Grid Current | 15 | ma |
| R-F Control Grid Current | 5 | amp |
| Plate Dissipation | 40 | watts |
| Screen Dissipation | 15 | watts |

TYPICAL OPERATION

| | Telephony Control Grid Modulation | Telephony Suppressor Grid Modulation | Telephony Plate & Screen Modulation | Telephony | Telephony | Volts | |
|-----------------------|-----------------------------------|--------------------------------------|-------------------------------------|-----------|-----------|-------|-------|
| D-C Plate Voltage | 1250 | 1250 | 1000 | 1250 | 1250 | volts | |
| D-C Screen Voltage | 300 | 300 | 300 | 300 | 300 | volts | |
| D-C Sup. Grid Volt. | 0 +45 | -45 | 0 | 0 | +45 | volts | |
| D-C Con. Grid Volt. | -142 -142 | -100 | -100 | -100 | -100 | volts | |
| D-C Plate Current | 40 | 40 | 48 | 75 | 80 | ma | |
| D-C Screen Current | 7 | 7 | 44 | 30 | 43 | ma | |
| D-C Con. Grid Current | 1.8 | 1.8 | 11.5 | 10 | 11.5 | ma | |
| Screen Resistor | — | — | 23000 Ω | — | — | ohms | |
| Peak R-F Input Volt. | 160 | 160 | 140 | 145 | 155 | volts | |
| R-F Driving Power | 1.5* | 1.5* | 1.3 | 1.6 | 1.6 | watts | |
| Carrier Power Output | 17 | 20 | 21 | 52 | 64 | 84 | watts |
| Peak A-F Volt.—Plate | — | — | — | 1000* | — | volts | |
| Peak A-F Volt.—Grid | 30* | 30* | 75* | 300* | — | volts | |
| A-F Modulating Power | 0.3* | 0.3* | 0.36* | 52 | — | watts | |
| Peak Power Output | 68* | 80* | 84* | 208* | — | watts | |

*At the peak of the a-f cycle with 100% modulation.
 Ω Connected to plate end of modulation trans. and by-passed for r.f. only.

R-F POWER AMPLIFIER—CLASS B—TELEPHONY

MAXIMUM RATINGS

| | | |
|------------------------------|------|-------|
| D-C Plate Voltage | 1250 | volts |
| D-C Screen Voltage | 300 | volts |
| D-C Plate Current (Carrier) | 70 | ma |
| Plate Dissipation (Carrier) | 40 | watts |
| Screen Dissipation (Carrier) | 15 | watts |

TYPICAL OPERATION

| | | |
|-----------------------------|------|-------|
| D-C Plate Voltage | 1250 | volts |
| D-C Screen Voltage | 300 | volts |
| D-C Suppressor Grid Voltage | 0 | volts |
| D-C Grid Voltage | -30 | volts |
| D-C Plate Current | 43 | ma |
| D-C Screen Current | 15 | ma |
| Peak R-F Input Voltage | 70* | volts |
| R-F Driving Power | 0.5* | volts |
| Carrier Power Output | 16 | watts |
| Peak Power Output | 64* | watts |

*At the peak of the a-f cycle with 100% modulation.

OPERATING NOTES

FREQUENCY RANGE

The RK-20A may be operated at the maximum ratings at frequencies up to 30 megacycles. At frequencies between 30 megacycles and 60 megacycles the maximum d-c plate voltage should not exceed 900 volts. The operation of the tube at frequencies higher than 60 megacycles is not recommended.

EXCITATION

The Class C amplifier characteristic curves show the power output, plate current and screen current plotted vs. excitation as denoted by the control grid current in milliamperes. The power output flattens off around 11 or 12 ma. of grid current with very little gained beyond these values. The screen dissipation increases with excitation and for this reason the excitation should be kept at a reasonable value.

SCREEN VOLTAGE

The screen voltage may be obtained either from a separate source or through a dropping resistor from the plate supply. The screen should always be by-passed to the filament midpoint for r.f.

SHIELDING

Shielding of the grid input tuning system from the plate tuning apparatus is desirable and will provide improved stability. If a shield is applied to the RK-20A it should enclose the base and extend to the lower internal shield and should clear the glass bulb by at least 1/16".

BIAS

Battery bias, or at least partial battery bias on the control grid is recommended. Additional bias may be obtained by placing a resistor in series with the battery.

CRYSTAL OSCILLATOR

Using crystal control, 50 watts of r-f power output may be obtained without overheating the crystal.

PLATE TEMPERATURE

The plate of the RK-20A will not show color when operated at its rated plate dissipation. Dissipations above the rated value should be avoided.

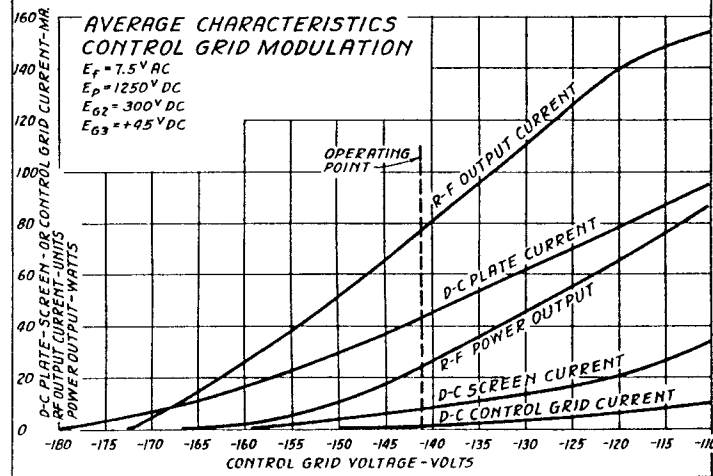
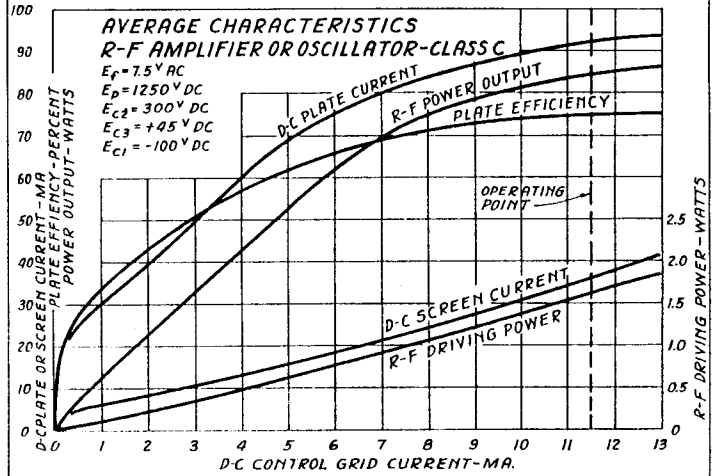
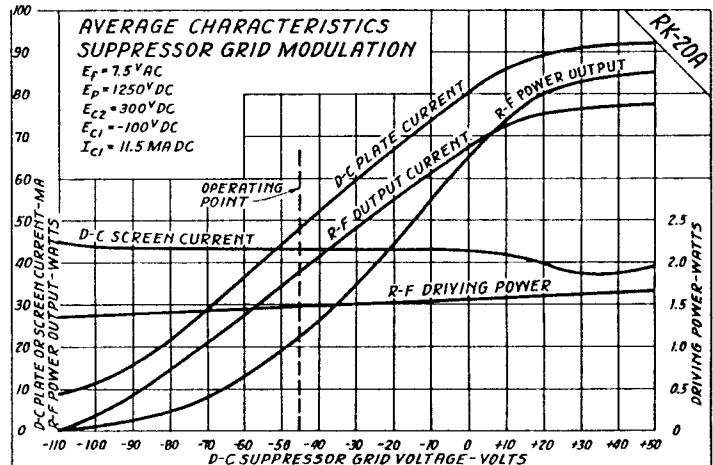
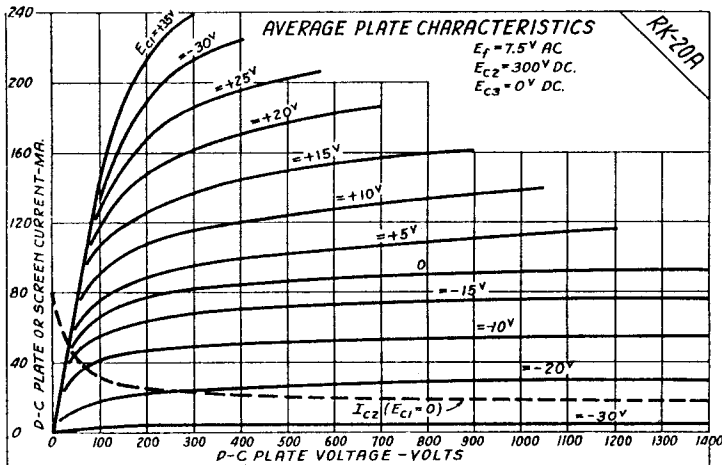

**PENTODE
POWER AMPLIFIER
OSCILLATOR**

The RK-23 and the RK-25 are heater type pentode power amplifier tubes having isolantite bases. The RK-25B is similar to the RK-25 except that the base is of bakelite. These tubes are designed for use as power amplifiers, oscillators or frequency multipliers. They may also be used in circuits employing suppressor or control grid modulation.

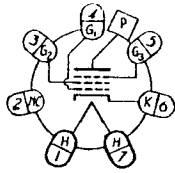

BOTTOM VIEW OF SOCKET

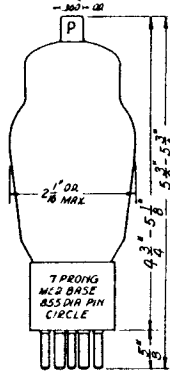

HEATER RATING

| | | | |
|----------------|-----------|-----------|-------|
| Heater Voltage | RK-23 2.5 | RK-25 6.3 | volts |
| Heater Current | 2 | 0.9 | amp |

DIRECT INTERELECTRODE CAPACITANCES

| | | |
|---------------|-----|-----|
| Grid to Plate | 0.2 | μuf |
| Input | 10 | μuf |
| Output | 10 | μuf |

R-F POWER AMP. OR OSC.—CLASS C

| | | | |
|-----------------------------|-----|-------|--|
| MAXIMUM RATINGS | | | |
| D-C Plate Voltage—Telephony | 500 | volts | |

| | | |
|-----------------------------------|-----|-------|
| D-C Plate Voltage—Telephony | 500 | volts |
| With Con. or Sup. Grid Modulation | 400 | volts |
| With Plate & Screen Modulation | 250 | volts |
| D-C Screen Voltage | 60 | ma |
| D-C Plate Current | 10 | ma |
| D-C Control Grid Current | 10 | watts |
| Plate Dissipation | 10 | watts |
| Screen Dissipation | 8 | watts |

TYPICAL OPERATION

| | Telephony Control Grid Modulation | Telephony Suppressor Grid Modulation | Telephony Plate & Screen Modulation | Telephony | |
|-----------------------|-----------------------------------|--------------------------------------|-------------------------------------|-----------|-------|
| D-C Plate Voltage | 500 | 500 | 400 | 500 | volts |
| D-C Screen Voltage | 200 | 200 | 150 | 200 | volts |
| D-C Sup. Grid Voltage | 0 +45 | -45 | 0 | 0 +45 | volts |
| D-C Con. Grid Volt. | -125 -125 | -90 | -90 | -90 -90 | volts |
| D-C Plate Current | 32 34 | 31 | 43 | 50 55 | ma |
| D-C Screen Current | 20 20 | 39 | 30 | 40 38 | ma |
| D-C Con. Grid Current | 1.5 1.5 | 4 | 6 | 4 4 | ma |
| Screen Resistor | — | — | 8300† | — | ohms |
| Peak R-F Input Volt. | 150 150 | 135 | 145 | 135 135 | volts |
| R-F Driving Power | 1.2* 1.3* | 0.5 | 0.8 | 0.5 0.5 | watts |
| Carrier Power Output | 5.5 6.5 | 6 | 13.5 | 18 22 | watts |
| Peak A-F Volt.—Plate | — | — | 400* | — | volts |
| Peak A-F Volt.—Grid | 45* 45* | 75* | 150* | — | volts |
| A-F Modulating Power | 0.5* 0.55* | 0.3* | 14.5 | — | watts |
| Peak Power Output | 22* 26* | 24* | 54* | — | watts |

*At the peak of the a-f cycle with 100% modulation.
†Connected to plate end of modulation trans. and by-passed for r.f. only.

R-F POWER AMPLIFIER—CLASS B—TELEPHONY

MAXIMUM RATINGS

| | | |
|------------------------------|-----|-------|
| D-C Plate Voltage | 500 | volts |
| D-C Screen Voltage | 250 | volts |
| D-C Plate Current (Carrier) | 35 | ma |
| Plate Dissipation (Carrier) | 10 | watts |
| Screen Dissipation (Carrier) | 8 | watts |

TYPICAL OPERATION

| | | |
|-----------------------------|-------|-------|
| D-C Plate Voltage | 500 | volts |
| D-C Screen Voltage | 200 | volts |
| D-C Suppressor Grid Voltage | 0 | volts |
| D-C Control Grid Voltage | -38 | volts |
| D-C Plate Current | 30 | ma |
| D-C Screen Current | 12 | ma |
| Peak R-F Input Voltage | 80 * | volts |
| R-F Driving Power | 0.24* | watts |
| Carrier Power Output | 5 | watts |
| Peak Power Output | 20 * | watts |

*At the peak of the a-f cycle with 100% modulation.

OPERATING NOTES

FREQUENCY RANGE

The RK-23, RK-25 and RK-25B may be operated at the maximum ratings at frequencies up to 30 megacycles. Above 30 megacycles the reduced efficiency realized requires that the plate voltage be lowered to prevent the plate dissipation from exceeding the maximum rated value.

EXCITATION

The Class C amplifier characteristic curves show the power output, plate current and screen current plotted vs. excitation as denoted by the d-c control grid current in milliamperes. The power output flattens off around 4 or 5 ma. of grid current with very little gained beyond these values. The screen dissipation increases with excitation and for this reason the excitation should be kept at a reasonable value.

SCREEN VOLTAGE

The screen voltage may be obtained either from a separate source or through a dropping resistor from the plate supply. The screen should always be by-passed to the cathode for r.f.

SHIELDING

Shielding of the grid input tuning system from the plate tuning apparatus is desirable and will provide improved stability. If a shield is applied to the RK-23, RK-25 or RK-25B, it should enclose the base and extend to the lower internal shield and should clear the glass bulb by at least 1/16".

BIAS

At least 25 volts of fixed bias should be used with 500 volts on the plate to protect the tube in case of failure of the bias or excitation. Additional bias may be obtained by the use of a grid or cathode resistor.

CRYSTAL OSCILLATOR

Using crystal control, 20 watts of r-f power output may be obtained without overheating the crystal.

PLATE TEMPERATURE

The plate of the RK-23, RK-25 or RK-25B will not show color when operated at the rated plate dissipation. Dissipations above the rated value should be avoided.

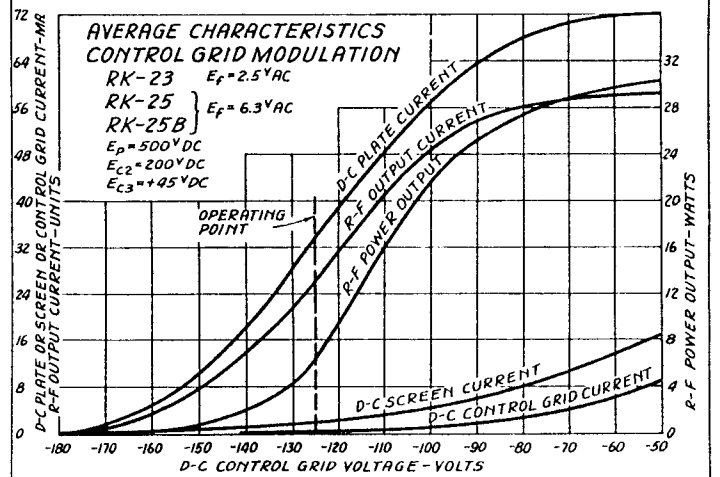
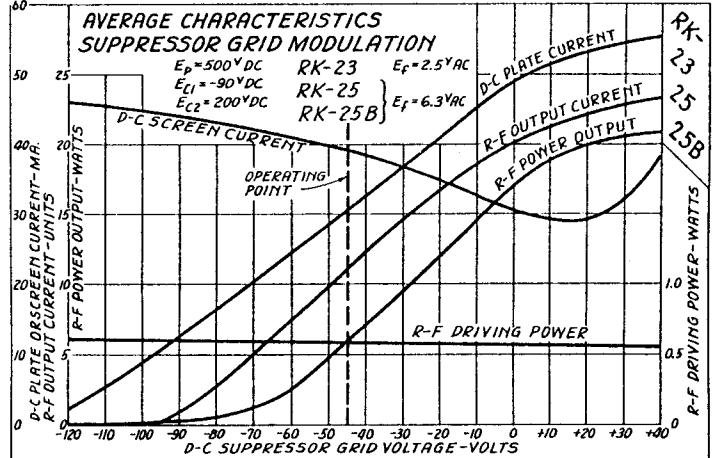
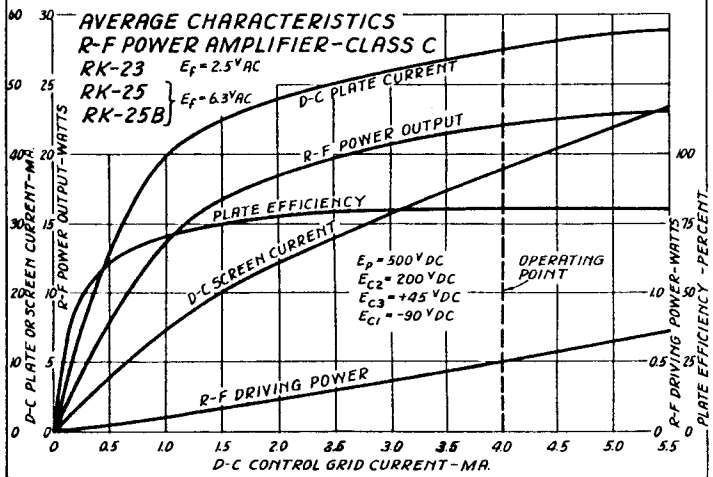
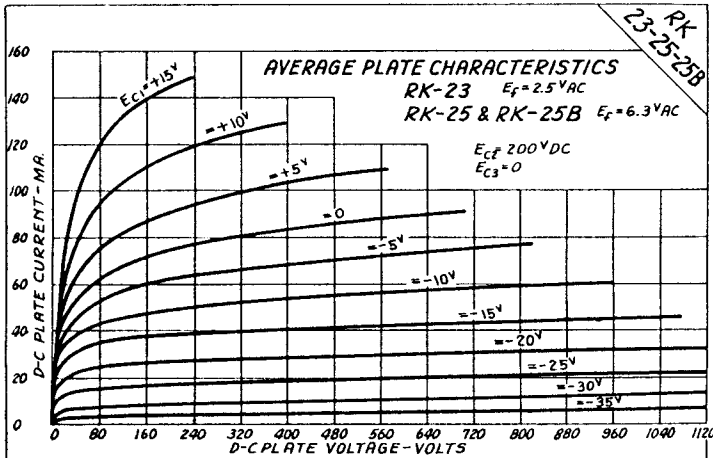

TRIODE AMPLIFIER OSCILLATOR

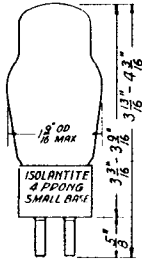

The RK-24 is a triode type amplifier tube having a coated filament and an isolantite base. It is designed for use as an amplifier or oscillator in transceivers and portable equipment at ultra-high frequencies. It will supply more power output and give better life than the type 30 in these applications.

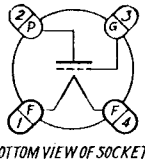

BOTTOM VIEW OF SOCKET

FILAMENT RATING

| | | |
|------------------|---------|-------|
| Filament Voltage | 2.0 d-c | volts |
| Filament Current | 0.12 | amp |

DIRECT INTERELECTRODE CAPACITANCES

| | | |
|---------------|-----|---------------|
| Grid to Plate | 5.5 | μf |
| Input | 3.5 | μf |
| Output | 3.0 | μf |

A-F AMPLIFIER—CLASS A

MAXIMUM RATINGS

| | | |
|-------------------|-----|-------|
| D-C Plate Voltage | 180 | volts |
| Plate Dissipation | 1.5 | watts |

TYPICAL OPERATION

| | | | | |
|----------------------|------|------|-------|-----------------|
| D-C Plate Voltage | 90 | 135 | 180 | volts |
| D-C Grid Voltage | -4.5 | -9 | -13.5 | volts |
| D-C Plate Current | 4.5 | 6 | 8 | ma |
| Amplification Factor | 8 | 8 | 8 | |
| Plate Resistance | 5500 | 5300 | 5000 | ohms |
| Transconductance | 1450 | 1500 | 1600 | μhos |
| Load Resistance | 5000 | 9000 | 12000 | ohms |
| Power Output | 25 | 110 | 250 | mw |

R-F AMPLIFIER OR OSCILLATOR—CLASS C

MAXIMUM RATINGS

| | | |
|-------------------|-----|-------|
| D-C Plate Voltage | 180 | volts |
| D-C Plate Current | 20 | ma |
| D-C Grid Current | 6 | ma |
| Plate Dissipation | 1.5 | watts |

TYPICAL OPERATION

| | | |
|------------------------|------|-------|
| D-C Plate Voltage | 180 | volts |
| D-C Grid Voltage | -45 | volts |
| D-C Plate Current | 16.5 | ma |
| D-C Grid Current | 6 | ma |
| Peak R-F Input Voltage | 92 | volts |
| R-F Driving Power | 0.5 | watts |
| Power Output | 2 | watts |

OPERATING NOTES

FREQUENCY RANGE

The RK-24 is particularly adapted for use in circuits operating at frequencies from 60 to 112 megacycles.

FILAMENT VOLTAGE

The filament voltage at the socket of the RK-24 should be maintained at 2 volts in order to insure long life.

PLATE TEMPERATURE

The plate of the RK-24 will not show color when operated at the maximum rated dissipation. Dissipations above the rated value should be avoided.

TRANSCEIVER

The circuit below is the "Minute Man" receiver converted for use as a transceiver as shown in A.R.R.L.'s QST-magazine for September 1936.

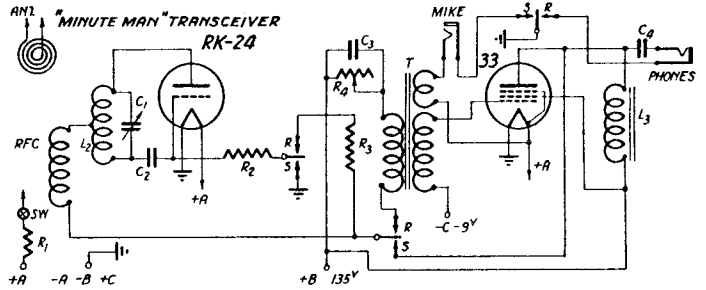

- C₁ — Two-plate midget variable, low loss
- C₂ — 100 μf d.
- C₃ — 0.25 μf d.
- L₁ — 0.1 μf d.
- L₂ — 10 turns No. 14, 1/2 inch inside diameter, spaced diameter of wire.
- L₃ — Transceiver Transformer.
- RFC — 45 turns No. 25 cotton-covered wire, inside diameter 1/4 inch, close wound and self-supporting.
- R₁ — 3 ohms
- R₂ — 10,000 ohms
- R₃ — 5 megohms.
- R₄ — 50,000 ohms variable
- L₁ — Four turns in flat spiral

AVERAGE PLATE CHARACTERISTICS

$E_f = 2.0V$ DC

RK-24

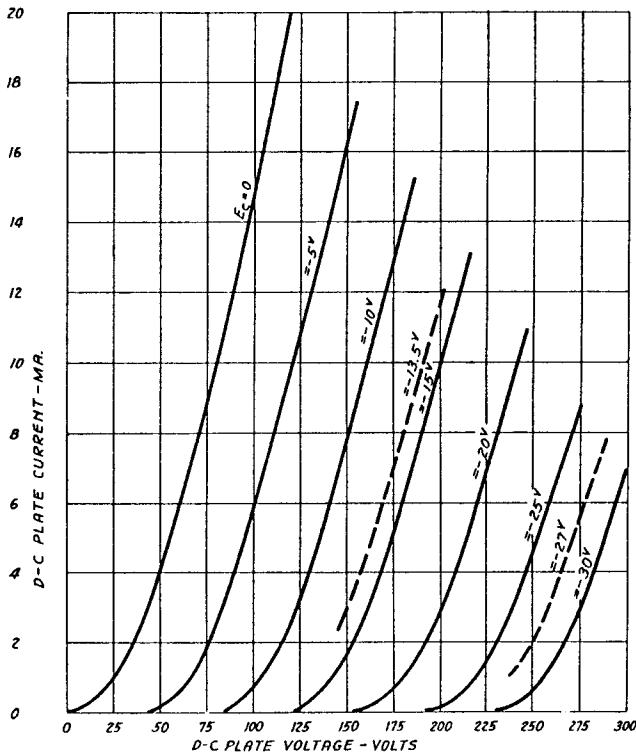

AVERAGE CHARACTERISTICS

R-F POWER AMPLIFIER—CLASS C

$E_f = 2.0V$ DC
 $E_p = 180V$ DC
 $E_g = -45V$ DC

RK-24

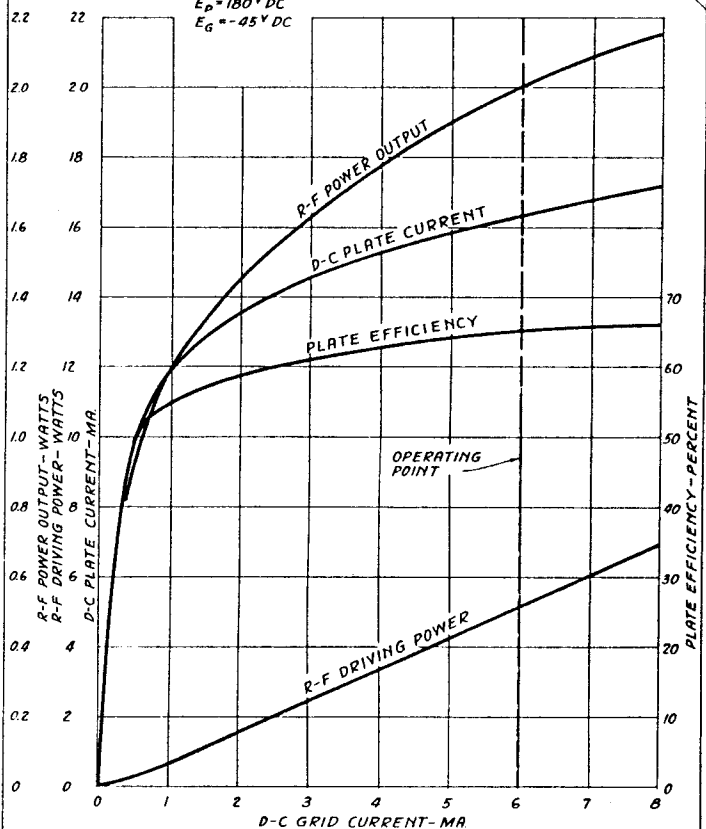

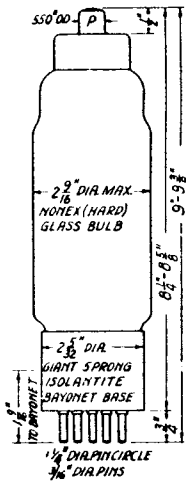

PENTODE POWER AMPLIFIER OSCILLATOR

The RK-28 is a pentode type power amplifier tube having a thoriated tungsten filament, a molybdenum plate, a hard glass bulb and an isolantite base. It is designed for use as a power amplifier, oscillator or frequency multiplier. The RK-28 may also be used in circuits employing suppressor or control grid modulation.

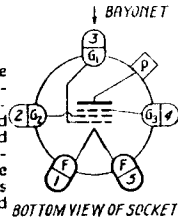

FILAMENT RATING

| | | |
|------------------|----|-------|
| Filament Voltage | 10 | volts |
| Filament Current | 5 | amp |

DIRECT INTERELECTRODE CAPACITANCES

| | | |
|---------------|------|-----|
| Grid to Plate | 0.02 | μmf |
| Input | 15 | μmf |
| Output | 15 | μmf |

R-F POWER AMP. OR OSC.—CLASS C

| MAXIMUM RATINGS | | |
|--|------|-------|
| D-C Plate Voltage—Telegraphy | 2000 | volts |
| D-C Plate Voltage—Telephony | 2000 | volts |
| With Con. Grid or Sup. Grid Modulation | 1500 | volts |
| D-C Screen Voltage | 400 | volts |
| D-C Plate Current | 150 | ma |
| D-C Control Grid Current | 25 | ma |
| R-F Control Grid Current | 8 | amp |
| Plate Dissipation | 100 | watts |
| Screen Dissipation | 35 | watts |

TYPICAL OPERATION

| | Telephony Control Grid Modulation | Telephony Suppressor Grid Modulation | Telephony Plate & Screen Modulation | Telegraphy |
|-----------------------|-----------------------------------|--------------------------------------|-------------------------------------|------------|
| D-C Plate Voltage | 2000 | 2000 | 2000 | 1500 |
| D-C Screen Voltage | 400 | 400 | 400 | 400 |
| D-C Sup. Grid. Volt. | 0 +45 | -45 | 0 | +45 |
| D-C Con. Grid Volt. | -140 | -140 | -100 | -100 |
| D-C Plate Current | 85 | 80 | 85 | 135 |
| D-C Screen Current | 20 | 20 | 65 | 64 |
| D-C Con. Grid Current | 4 | 4 | 13 | 13 |
| Screen Resistor | — | — | 17000‡ | 21000‡ |
| Peak R-F Input Volt. | 170 | 170 | 150 | 170 |
| R-F Driving Power | 3.5 * | 3.5 * | 1.8 | 2.0 |
| Carrier Power Output | 70 | 75 | 60 | 135 |
| Peak A-F Volt.—Plate | — | — | — | 1500* |
| Peak A-F Volt.—Grid | 50 * | 50 * | 90 * | 400 * |
| A-F Modulating Power | 1.0 * | 1.0 * | 1.2 * | 150 |
| Peak Power Output | 280* | 300* | 240* | 540 * |

*At the peak of the a-f cycle with 100% modulation.
‡Connected to plate end of modulation trans. and by-passed for r.f. only.

R-F POWER AMPLIFIER—CLASS B—TELEPHONY

MAXIMUM RATINGS

| | | |
|------------------------------|------|-------|
| D-C Plate Voltage | 2000 | volts |
| D-C Screen Voltage | 400 | volts |
| D-C Plate Current | 80 | ma |
| Plate Dissipation (Carrier) | 100 | watts |
| Screen Dissipation (Carrier) | 35 | watts |

TYPICAL OPERATION

| | | |
|-----------------------------|-------|-------|
| D-C Plate Voltage | 2000 | volts |
| D-C Screen Voltage | 400 | volts |
| D-C Suppressor Grid Voltage | 0 | volts |
| D-C Control Grid Voltage | -38 | volts |
| D-C Plate Current | 75 | ma |
| D-C Screen Current | 30 | ma |
| Peak R-F Input Voltage | 90 * | volts |
| R-F Driving Power | 0.9 * | watts |
| Carrier Power Output | 50 | watts |
| Peak Power Output | 200* | watts |

*At the peak of the a-f cycle with 100% modulation.

OPERATING NOTES

FREQUENCY RANGE

The RK-28 may be operated at the maximum ratings at frequencies up to 30 megacycles. Above 30 megacycles the reduced efficiency realized requires that the plate voltage be lowered to a maximum of 1500 volts to prevent the plate dissipation from exceeding the maximum rated value. The operation of the tube at frequencies higher than 60 megacycles is not recommended.

EXCITATION

The Class C amplifier characteristic curves show the power output, plate current and screen current plotted vs. excitation as denoted by the d-c control grid current in milliamperes. The power output flattens off around 12 or 13 ma. of grid current with very little gained above these values. The screen dissipation increases with excitation and for this reason the excitation should be kept at a reasonable value.

SHIELDING

Shielding of the grid input tuning system from the plate tuning apparatus is desirable and will provide improved stability. If a shield is applied to the RK-28 it should enclose the base and extend to the lower internal shield and should clear the glass bulb by at least 1/16".

BIAS

At least 20 volts of fixed bias should be used with 2000 volts on the plate to protect the tube in case of failure of the bias or excitation. Additional bias may be obtained by the use of a grid or cathode resistor.

CRYSTAL OSCILLATOR

Using crystal control, 150 watts of r-f power output may be obtained without overheating the crystal.

PLATE TEMPERATURE

The plate of the RK-28 will show a light red color (See Plate Temperature Color Scale) when operated at the maximum rated plate dissipation. Dissipations above the rated value should be avoided.

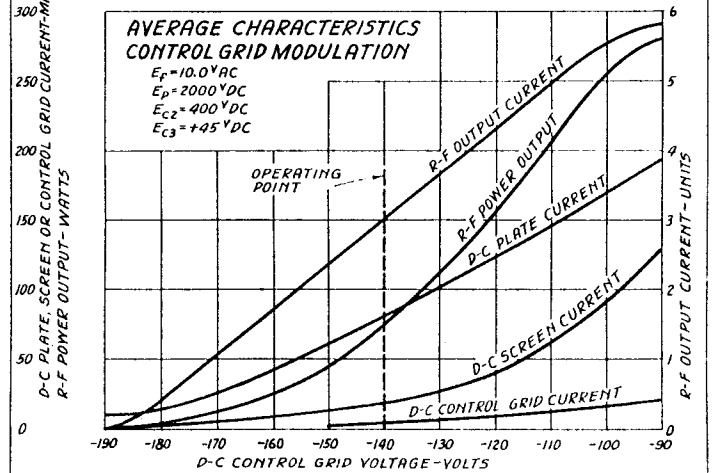
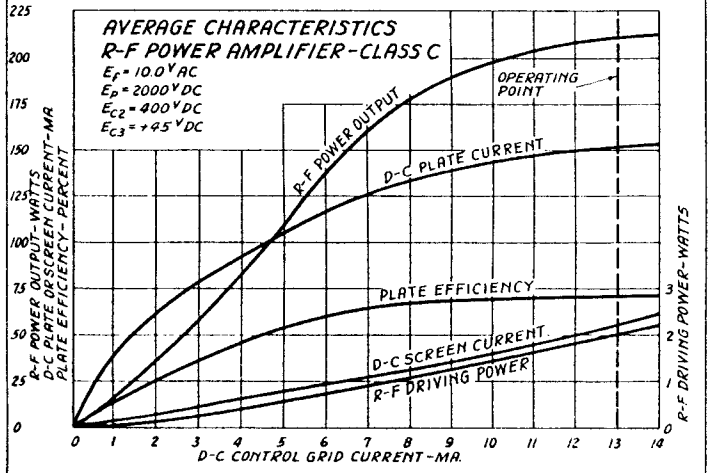
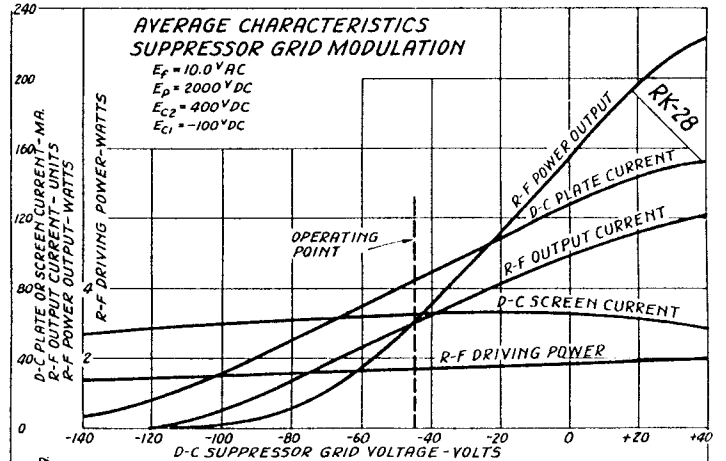
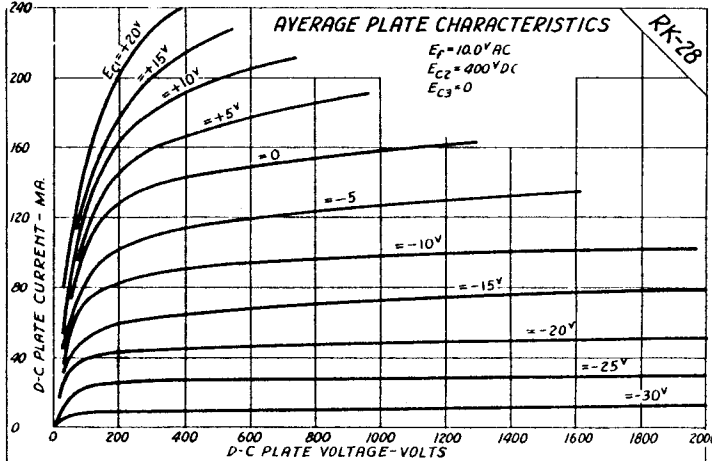

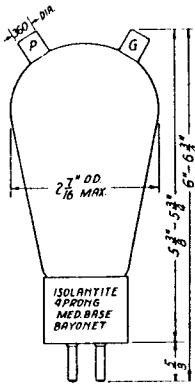

TRIODE POWER AMPLIFIER OSCILLATOR

The RK-30 is a triode type power amplifier tube having a thoriated tungsten filament, a molybdenum plate and an isolantite base. It is designed for use as a power amplifier, oscillator or frequency multiplier.

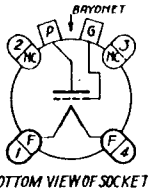

BOTTOM VIEW OF SOCKET

AMPLIFICATION FACTOR 15

FILAMENT RATING

| | | |
|------------------|------|-------|
| Filament Voltage | 7.5 | volts |
| Filament Current | 3.25 | amp |

DIRECT INTERELECTRODE CAPACITANCES

| | | |
|---------------|------|----------------|
| Grid to Plate | 2.5 | μmf |
| Input | 2.75 | μmf |
| Output | 2.75 | μmf |

R-F POWER AMPLIFIER OR OSCILLATOR—CLASS C MAXIMUM RATINGS

| | | |
|---------------------------------|------|-------|
| D-C Plate Voltage—Telegraphy | 1250 | volts |
| D-C Plate Voltage—Telephony | 1000 | volts |
| With Grid Modulation | 1250 | volts |
| With Plate Modulation | 1000 | volts |
| D-C Plate Current | 80 | ma |
| D-C Grid Current | 25 | ma |
| Plate Dissipation—Telegraphy | 35 | watts |
| Plate Dissipation—Telephony | 35 | watts |
| With Grid Modulation (Carrier) | 35 | watts |
| With Plate Modulation (Carrier) | 23 | watts |

TYPICAL OPERATION

| | Telephony Grid Modulation | Telephony Plate Modulation | Telegraphy | |
|-----------------------------|---------------------------------|----------------------------------|------------|-------|
| D-C Plate Voltage | 1250 | 1000 | 1250 | volts |
| D-C Grid Voltage | -140 | -200 | -180 | volts |
| D-C Plate Current | 40 | 90 | 80 | ma |
| D-C Grid Current | 1.5 | 15 | 18 | ma |
| Peak R-F Input Voltage | 170 | 320 | 320 | volts |
| R-F Driving Power | 1.5* | 4.5 | 5.2 | watts |
| Carrier Power Output | 18 | 60 | 85 | watts |
| Peak A-F Modulating Voltage | 60* | 1000* | — | volts |
| A-F Modulating Power | 0.5* | 40 | — | watts |
| Peak Power Output | 72* | 240* | — | watts |

*At the peak of the a-f cycle with 100% modulation.

R-F POWER AMPLIFIER—CLASS B—TELEPHONY

MAXIMUM RATINGS

| | | |
|-----------------------------|------|-------|
| D-C Plate Voltage | 1250 | volts |
| D-C Plate Current (Carrier) | 55 | ma |
| Plate Dissipation (Carrier) | 35 | watts |

TYPICAL OPERATION

| | | |
|------------------------|------|-------|
| D-C Plate Voltage | 1250 | volts |
| D-C Grid Voltage | -70 | volts |
| D-C Plate Current | 40 | ma |
| D-C Grid Current | 1.3 | ma |
| Peak R-F Input Voltage | 200* | volts |
| R-F Driving Power | 2.5* | watts |
| Carrier Power Output | 18 | watts |
| Peak Power Output | 72* | watts |

A-F POWER AMPLIFIER—CLASS B—TWO TUBES

MAXIMUM RATINGS

| | | |
|------------------------------|------|-------|
| D-C Plate Voltage | 1250 | volts |
| D-C Plate Current (per tube) | 80 | ma |
| Plate Dissipation (per tube) | 35 | atts |
| (Averaged over 1 cycle) | | |

TYPICAL OPERATION

| | | |
|---------------------------------------|-------|-------|
| D-C Plate Voltage | 1250 | volts |
| D-C Grid Voltage | -70 | volts |
| D-C Plate Current (no signal) | 30 | ma |
| D-C Plate Current (max. signal) | 130 | ma |
| D-C Grid Current (max. signal) | 26 | ma |
| Peak A-F Input Voltage (grid to grid) | 300 | volts |
| A-F Driving Power | 3.4 | watts |
| Load Resistance (plate to plate) | 21000 | ohms |
| Power Output | 106 | watts |

*At the peak of the a-f cycle with 100% modulation.

OPERATING NOTES

FREQUENCY RANGE

The RK-30 may be operated at the maximum ratings at frequencies up to 60 megacycles. At frequencies between 60 megacycles and 120 megacycles the maximum d-c plate voltage should not exceed 1000 volts. Above 120 megacycles the maximum d-c plate voltage should not exceed 750 volts.

BIAS

At least 55 volts of fixed bias should be used with 1250 volts on the plate to protect the tube in case of failure of the bias or excitation. The fixed bias may be reduced with lower plate voltages.

PLATE TEMPERATURE

The plate of the RK-30 will show a dull, cherry red color (See Plate Temperature Color Scale) when operated at the maximum rated plate dissipation. Dissipations above the rated value should be avoided.

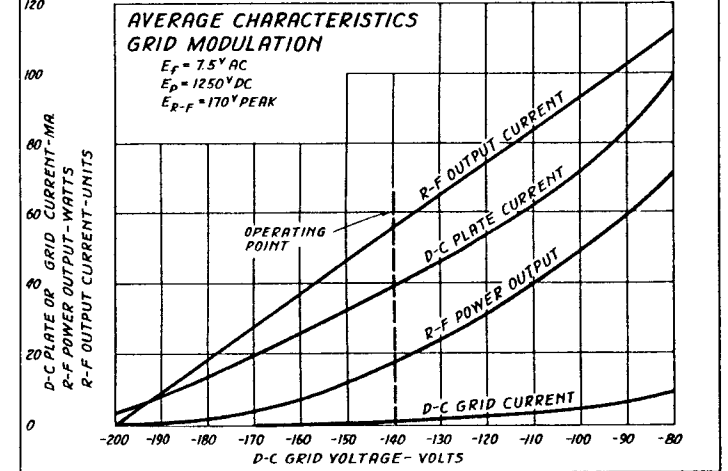
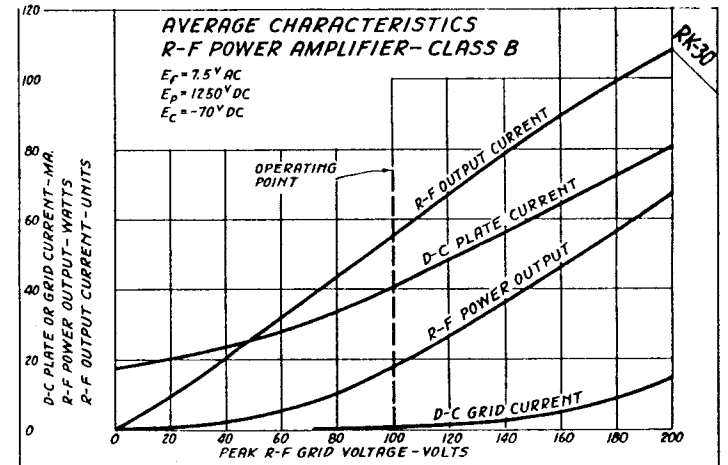
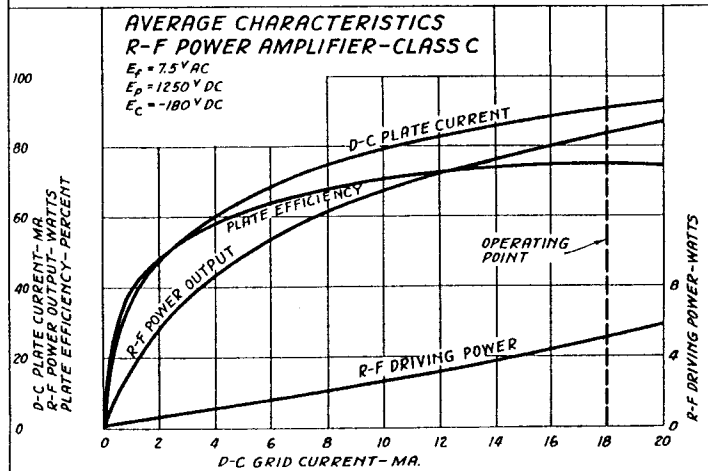
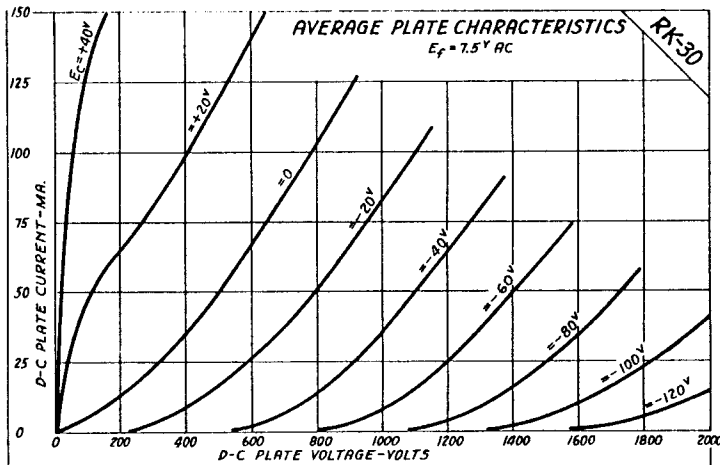

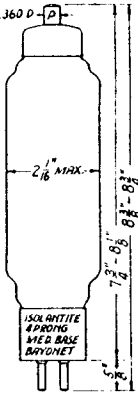

**TRIODE
POWER AMPLIFIER
OSCILLATOR**

The RK-31 is a high-mu triode power amplifier tube having a thoriated tungsten filament, a molybdenum plate and an isolantite base. It is designed for use as a power amplifier, oscillator or frequency multiplier.

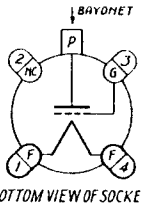

BOTTOM VIEW OF SOCKET

FILAMENT RATING

| | | |
|------------------|-----|-------|
| Filament Voltage | 7.5 | volts |
| Filament Current | 3.0 | amp |

DIRECT INTERELECTRODE CAPACITANCES

| | | |
|---------------|----|---------|
| Grid to Plate | 10 | μ f |
| Input | 7 | μ f |
| Output | 2 | μ f |

A-F POWER AMPLIFIER—CLASS B—TWO TUBES

MAXIMUM RATINGS

| | | |
|---|------|-------|
| D-C Plate Voltage | 1250 | volts |
| D-C Plate Current (per tube) | 115 | ma |
| Plate Dissipation (per tube) (Averaged over 1 cycle) | 40 | watts |

TYPICAL OPERATION

| | | | |
|---------------------------------------|-------|-------|-------|
| D-C Plate Voltage | 1000 | 1250 | volts |
| D-C Grid Voltage | 0 | 0 | volts |
| D-C Plate Current (no signal) | 25 | 35 | ma |
| D-C Plate Current (max. signal) | 230 | 220 | ma |
| D-C Grid Current (max. signal) | 65 | 76 | ma |
| Peak A-F Input Voltage (grid to grid) | 141 | 141 | volts |
| A-F Driving Power | 3.7 | 4.4 | watts |
| Load Resistance (plate to plate) | 11000 | 18000 | ohms |
| Power Output | 160 | 190 | watts |

**R-F POWER AMPLIFIER—CLASS C—TELEGRAPHY
MAXIMUM RATINGS**

| | | |
|-------------------|------|-------|
| D-C Plate Voltage | 1250 | volts |
| D-C Plate Current | 100 | ma |
| D-C Grid Current | 35 | ma |
| R-F Grid Current | 5 | amp |
| Plate Dissipation | 40 | watts |

TYPICAL OPERATION

| | | |
|------------------------|------|-------|
| D-C Plate Voltage | 1250 | volts |
| D-C Grid Voltage | -80 | volts |
| D-C Plate Current | 100 | ma |
| D-C Grid Current | 30 | ma |
| Peak R-F Input Voltage | 145 | volts |
| R-F Driving Power | 3.9 | watts |
| Power Output | 90 | watts |

**R-F POWER AMPLIFIER—CLASS C—PLATE MODULATION
MAXIMUM RATINGS**

| | | |
|-------------------|------|-------|
| D-C Plate Voltage | 1000 | volts |
| D-C Plate Current | 100 | ma |
| D-C Grid Current | 35 | ma |
| Plate Dissipation | 30 | watts |

TYPICAL OPERATION

| | | |
|------------------------|------|-------|
| D-C Plate Voltage | 1000 | volts |
| D-C Grid Voltage | -80 | volts |
| D-C Plate Current | 100 | ma |
| D-C Grid Current | 28 | ma |
| Peak R-F Input Voltage | 140 | volts |
| R-F Driving Power | 3.5 | watts |
| Carrier Power Output | 70 | watts |
| A-F Modulating Power | 50 | watts |
| Peak Power Output | 280 | watts |

OPERATING NOTES

FREQUENCY RANGE

The RK-31 may be operated at the maximum ratings at frequencies up to 30 megacycles. Above 30 megacycles the reduced efficiency realized requires that the plate voltage be lowered to prevent the plate dissipation from exceeding the maximum rated value.

PLATE TEMPERATURE

The plate of the RK-31 will show a light cherry red color (See Plate Temperature Color Scale) when operated at the maximum rated plate dissipation. Dissipations above the rated value should be avoided.

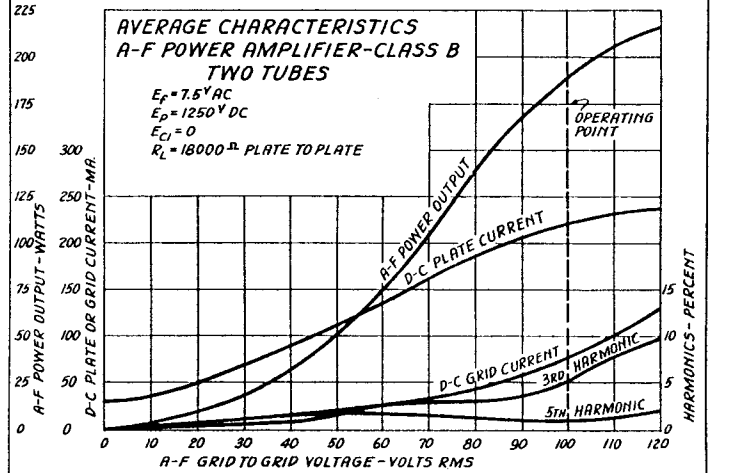
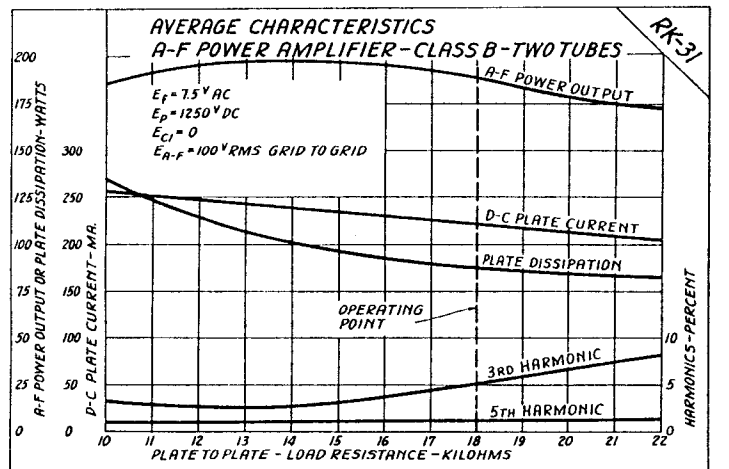
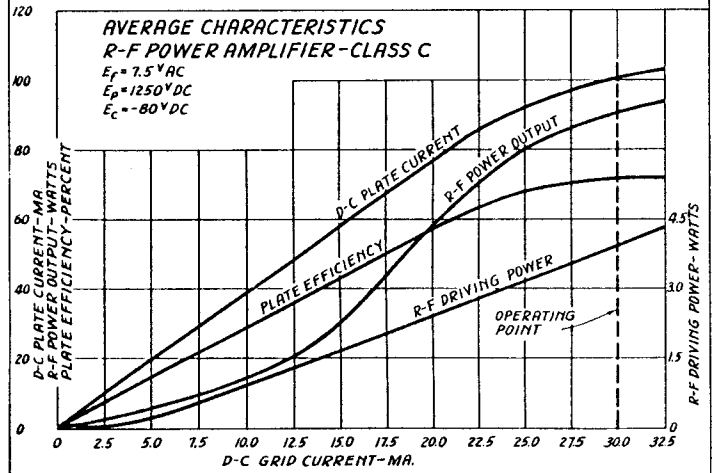
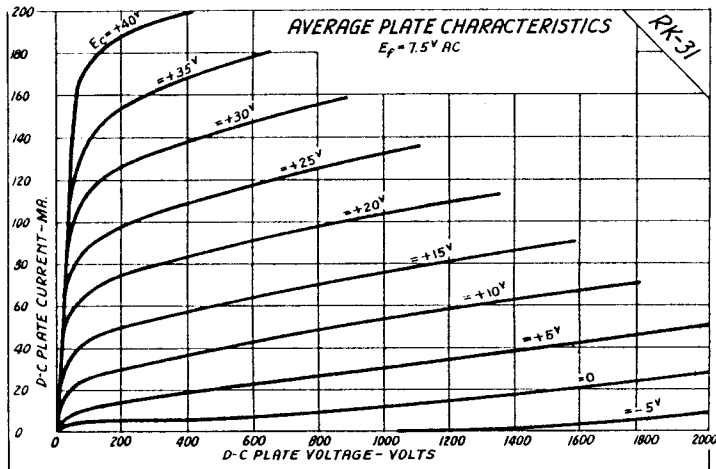

**TRIODE
POWER AMPLIFIER
OSCILLATOR**

The RK-32 is a triode type power amplifier tube having a thoriated tungsten filament, a tantalum plate and grid, a hard glass bulb and an isolantite base. It is designed for use as a power amplifier, oscillator or frequency multiplier.

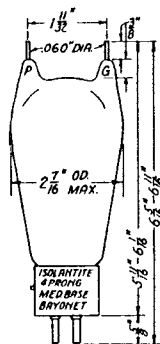
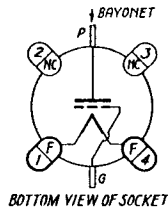

**AMPLIFICATION FACTOR 11
FILAMENT RATING**

| | | |
|------------------|------|-------|
| Filament Voltage | 7.5 | volts |
| Filament Current | 3.25 | amp |

DIRECT INTERELECTRODE CAPACITANCES

| | | |
|---------------|-----|----------------|
| Grid to Plate | 3.4 | μmf |
| Input | 2.5 | μmf |
| Output | 0.7 | μmf |

**R-F POWER AMPLIFIER—CLASS C—TELEGRAPHY
MAXIMUM RATINGS**

| | | |
|-------------------|------|-------|
| D-C Plate Voltage | 1250 | volts |
| D-C Plate Current | 100 | ma |
| D-C Grid Current | 25 | ma |
| Plate Dissipation | 50 | watts |

TYPICAL OPERATION

| | | |
|------------------------|------|-------|
| D-C Plate Voltage | 1250 | volts |
| D-C Grid Voltage | -225 | volts |
| D-C Plate Current | 100 | ma |
| D-C Grid Current | 14 | ma |
| Peak R-F Input Voltage | 380 | volts |
| R-F Driving Power | 4.8 | watts |
| Power Output | 90 | watts |

**R-F POWER AMPLIFIER—CLASS B—TELEPHONY
MAXIMUM RATINGS**

| | | |
|-------------------|------|-------|
| D-C Plate Voltage | 1250 | volts |
| D-C Plate Current | 66 | ma |
| Plate Dissipation | 50 | watts |

TYPICAL OPERATION

| | | |
|------------------------|------|-------|
| D-C Plate Voltage | 1250 | volts |
| D-C Grid Voltage | -120 | volts |
| D-C Plate Current | 50 | ma |
| Peak R-F Input Voltage | 200* | volts |
| R-F Driving Power | 2.5* | watts |
| Carrier Power Output | 21 | watts |
| Peak Power Output | 84 | watts |

*At the peak of the a-f cycle with 100% modulation.

R-F POWER AMPLIFIER—CLASS C—TELEPHONY

MAXIMUM RATINGS

| | Grid Modulation | Plate Modulation | |
|-----------------------------|-----------------|------------------|-------|
| D-C Plate Voltage | 1250 | 1000 | volts |
| D-C Plate Current (Carrier) | 100 | 100 | ma |
| D-C Grid Current (Carrier) | 25 | 25 | ma |
| Plate Dissipation (Carrier) | 50 | 32 | watts |

TYPICAL OPERATION

| | | | |
|-----------------------------|------|-------|-------|
| D-C Plate Voltage | 1250 | 1000 | volts |
| D-C Grid Voltage | -200 | -310 | volts |
| D-C Plate Current | 60 | 100 | ma |
| D-C Grid Current | 1.2 | 21 | ma |
| Peak R-F Input Voltage | 235 | 415 | volts |
| R-F Driving Power | 5* | 8.7 | watts |
| Carrier Power Output | 25 | 70 | watts |
| Peak A-F Modulating Voltage | 100* | 1000* | volts |
| A-F Modulating Power | 2.1* | 50 | watts |
| Peak Power Output | 100* | 280* | watts |

*At the peak of the a-f cycle with 100% modulation.

OPERATING NOTES

FREQUENCY RANGE

The RK-32 may be operated at the maximum ratings at frequencies up to 150 megacycles. Above 150 megacycles the reduced efficiency realized requires that the plate voltage be reduced to prevent the plate dissipation from exceeding the maximum rated value. The operation of the tube at frequencies higher than 300 megacycles is not recommended.

BIAS

At least 90 volts of fixed bias should be used with 1250 volts on the plate to protect the tube in case of failure of the bias or excitation. Additional bias may be obtained by the use of a grid or cathode resistor.

PLATE TEMPERATURE

The plate of the RK-32 will show an orange color (See Plate Temperature Color Scale) when operated at the maximum rated plate dissipation. Dissipations above the rated value should be avoided.

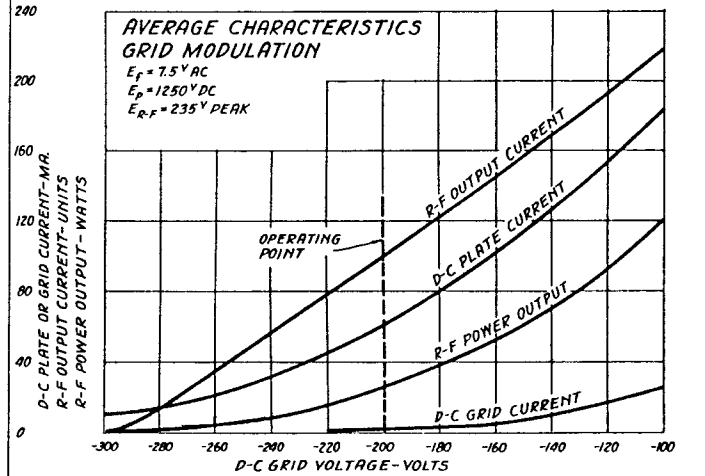
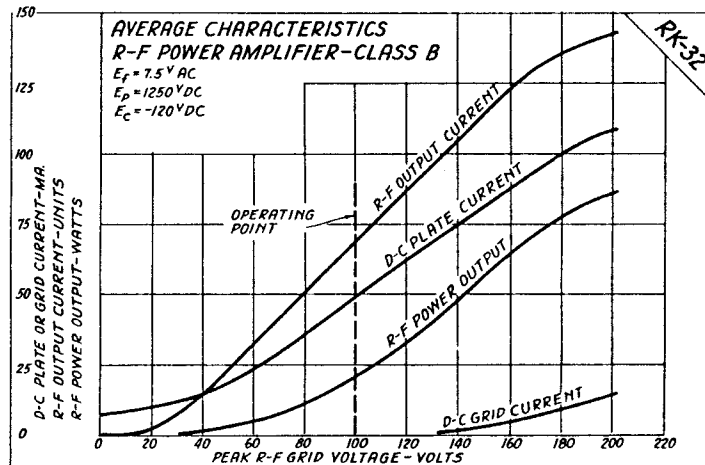
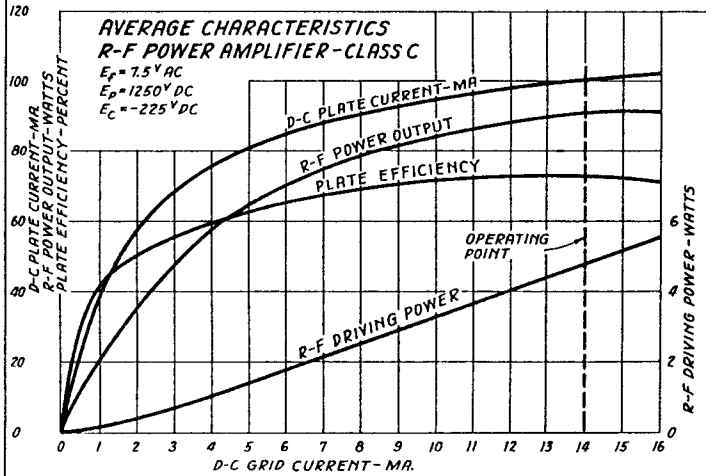
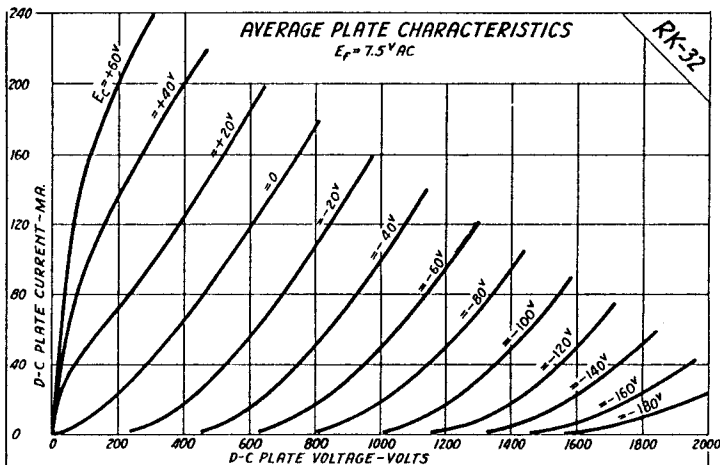

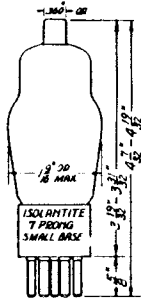

TWIN TRIODE AMPLIFIER OSCILLATOR

The RK-33 is a heater type twin triode amplifier tube having an isolantite base. It is designed for use in circuits where but one triode is operated at the maximum ratings. One triode may be operated at the maximum ratings as a Class C amplifier or oscillator while the other triode is operated as a low power oscillator, resistance coupled amplifier or detector.

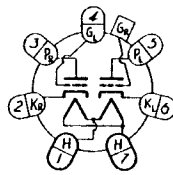

BOTTOM VIEW OF SOCKET

HEATER RATING

| | | |
|----------------------|-----|-------|
| Heater Voltage | 6.3 | volts |
| Heater Current | 0.6 | amp |

DIRECT INTERELECTRODE CAPACITANCES

| | Left Triode | Right Triode | |
|---------------------|-------------|--------------|---------------|
| Grid to Plate | 3 | 2 | μf |
| Input | 3 | 2 | μf |
| Output | 2.5 | 2.5 | μf |

A-F AMPLIFIER—CLASS A—ONE TRIODE

MAXIMUM RATINGS

| | | |
|-------------------------|-----|-------|
| D-C Plate Voltage | 250 | volts |
| Plate Dissipation | 2.5 | watts |

TYPICAL OPERATION

| | | |
|----------------------------|-------|------------------|
| D-C Plate Voltage | 250 | volts |
| D-C Grid Voltage | -16.5 | volts |
| D-C Plate Current | 8 | ma |
| Amplification Factor | 10.5 | |
| Plate Resistance | 8750 | ohms |
| Transconductance | 1200 | μmhos |
| Load Resistance | 20000 | ohms |

R-F POWER AMPLIFIER—CLASS C—TELEGRAPHY—ONE TRIODE

MAXIMUM RATINGS

| | | |
|-------------------------|-----|-------|
| D-C Plate Voltage | 250 | volts |
| D-C Plate Current | 20 | ma |
| D-C Grid Current | 6 | ma |
| Plate Dissipation | 2.5 | watts |

TYPICAL OPERATION

| | | |
|------------------------------|------|-------|
| D-C Plate Voltage | 250 | volts |
| D-C Grid Voltage | -60 | volts |
| D-C Plate Current | 20 | ma |
| D-C Grid Current | 6 | ma |
| Peak R-F Input Voltage | 100 | volts |
| R-F Driving Power | 0.54 | watts |
| Power Output | 3.5 | watts |

OPERATING NOTES

FREQUENCY RANGE

One triode of the RK-33 may be operated at the maximum ratings at frequencies up to 60 megacycles. Above 60 megacycles the reduced efficiency realized requires that the plate voltage be reduced to prevent the plate dissipation from exceeding the maximum rated value.

BIAS

At least 15 volts of fixed bias should be used with 250 volts on the plate to protect the tube in case of failure of the bias or excitation.

PLATE TEMPERATURE

The plate of the RK-33 will not show color when operated at the maximum rated plate dissipation. Dissipations above the rated value should be avoided.

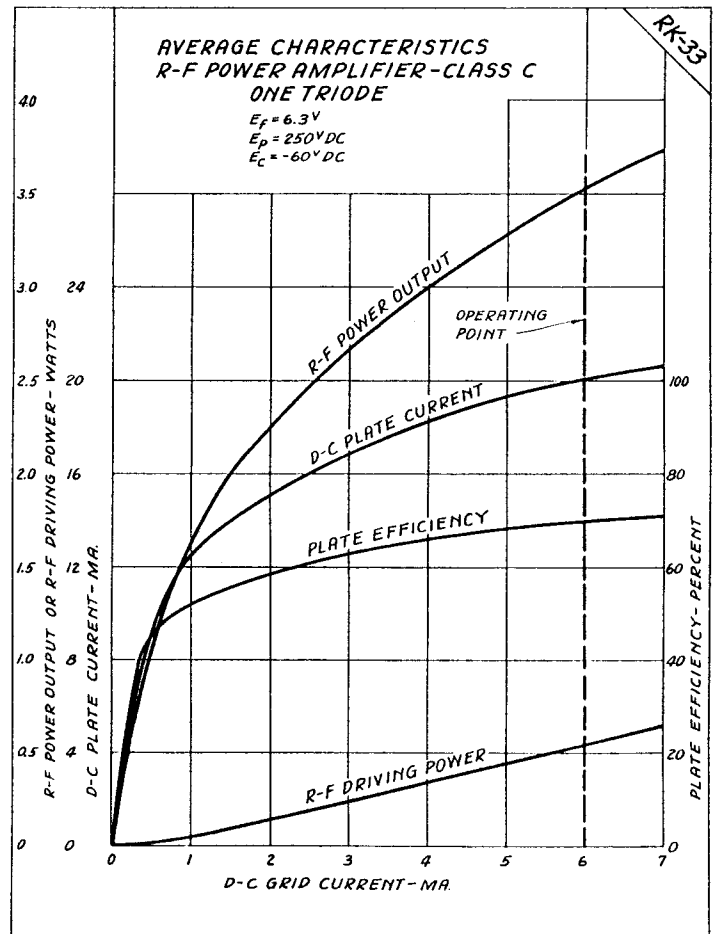
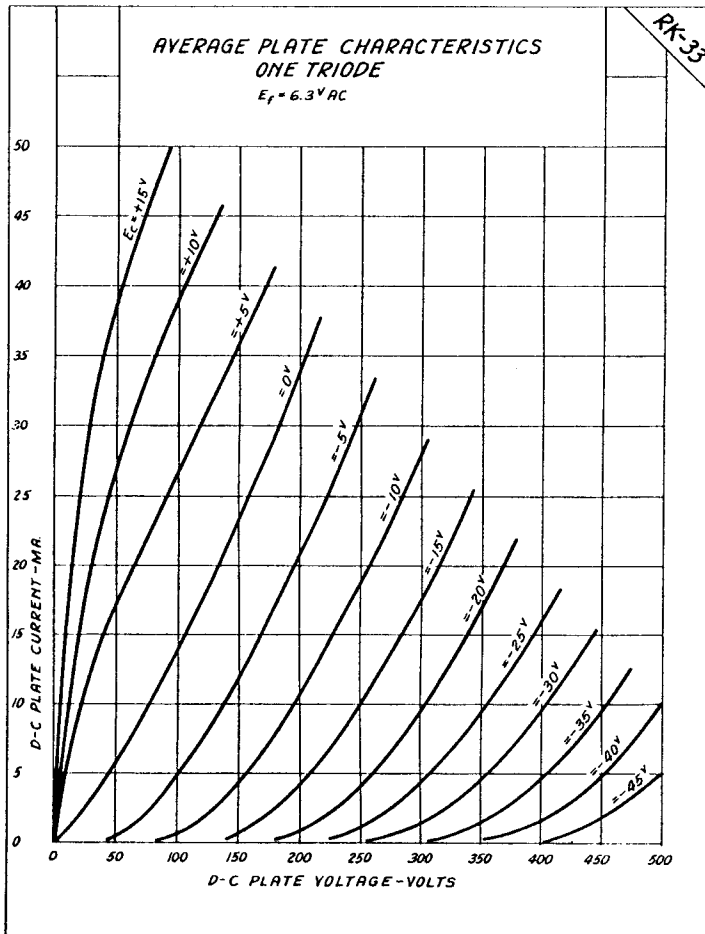

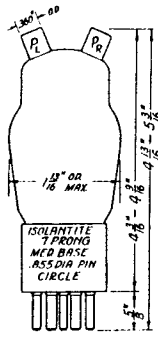

TWIN TRIODE POWER AMPLIFIER OSCILLATOR

The RK-34 is a heater type twin triode power amplifier tube having an isolantite base. It is designed for use as a power amplifier, oscillator or frequency multiplier.

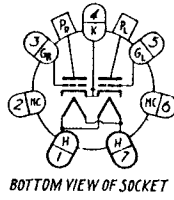

BOTTOM VIEW OF SOCKET

HEATER RATING

| | | |
|----------------|-----|-------|
| Heater Voltage | 6.3 | volts |
| Heater Current | 0.8 | amp |

DIRECT INTERELECTRODE CAPACITANCES—EACH TRIODE

| | | |
|---------------|-----|----------------|
| Grid to Plate | 2.7 | μmf |
| Input | 4.2 | μmf |
| Output | 0.8 | μmf |

R-F POWER AMPLIFIER OR OSCILLATOR—PUSH-PULL—CLASS C

MAXIMUM RATINGS

| | | |
|----------------------------------|-----|-------|
| D-C Plate Voltage | 300 | volts |
| D-C Plate Current (both triodes) | 80 | ma |
| Plate Dissipation (both triodes) | 10 | watts |
| (Averaged over 1 cycle) | | |

TYPICAL OPERATION

| | | |
|---------------------------------------|-----|-------|
| D-C Plate Voltage | 300 | volts |
| D-C Grid Voltage | -36 | volts |
| D-C Plate Current | 80 | ma |
| D-C Grid Current | 20 | ma |
| Peak R-F Input Voltage (grid to grid) | 196 | volts |
| R-F Driving Power | 1.8 | watts |
| Power Output | 16 | watts |

A-F POWER AMPLIFIER—CLASS B
MAXIMUM RATINGS

| | | |
|-----------------------------------|-----|-------|
| D-C Plate Voltage | 300 | volts |
| Peak Plate Current (both triodes) | 125 | ma |
| Plate Dissipation (both triodes) | 10 | watts |
| (Averaged over 1 cycle) | | |

TYPICAL OPERATION

| | | | |
|---------------------------------------|------|-------|-------|
| D-C Plate Voltage | 180 | 300 | volts |
| D-C Grid Voltage | -6 | -15 | volts |
| D-C Plate Current (no signal) | 30 | 30 | ma |
| D-C Plate Current (max. signal) | 70 | 70 | ma |
| D-C Grid Current (max. signal) | 16 | 12 | ma |
| Peak A-F Input Voltage (grid to grid) | 100 | 100 | volts |
| A-F Driving Power | 0.7 | 0.5 | watts |
| Load Resistance (plate to plate) | 6000 | 10000 | ohms |
| Power Output | 7.8 | 13 | watts |

A-F POWER AMPLIFIER—CLASS A
(Two Triodes Connected in Parallel)
MAXIMUM RATINGS

| | | |
|-------------------|-----|-------|
| D-C Plate Voltage | 300 | volts |
| Plate Dissipation | 10 | watts |

TYPICAL OPERATION

| | | |
|----------------------|------|------------------|
| D-C Plate Voltage | 300 | volts |
| D-C Grid Voltage | -16 | volts |
| D-C Plate Current | 25 | ma |
| Amplification Factor | 13 | |
| Plate Resistance | 2950 | ohms |
| Transconductance | 4400 | μmhos |
| Load Resistance | 5000 | ohms |
| Power Output | 0.8 | watts |

OPERATING NOTES

FREQUENCY RANGE

The RK-34 may be operated at the maximum ratings at frequencies up to 240 megacycles. Above 240 megacycles the reduced efficiency realized requires that the plate voltage be lowered to prevent the plate dissipation from exceeding the maximum rated value.

BIAS

At least 15 volts of fixed bias should be used with 300 volts on the plate to protect the tube in case of failure of the bias or excitation.

PLATE TEMPERATURE

The plates of the RK-34 will not show color when operated at the maximum rated plate dissipation. Dissipations above the rated value should be avoided.

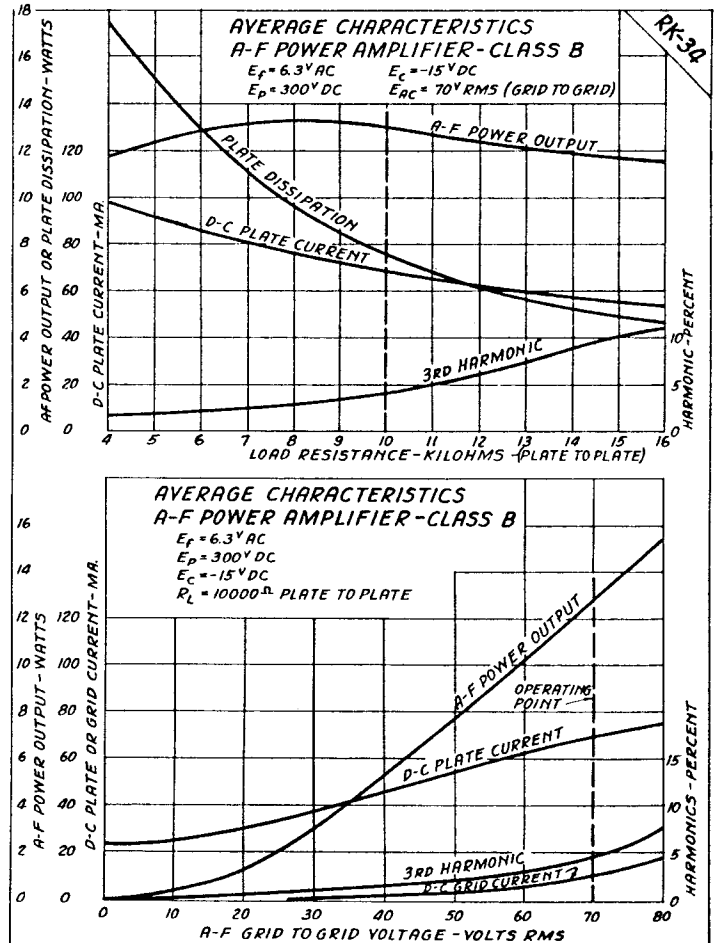
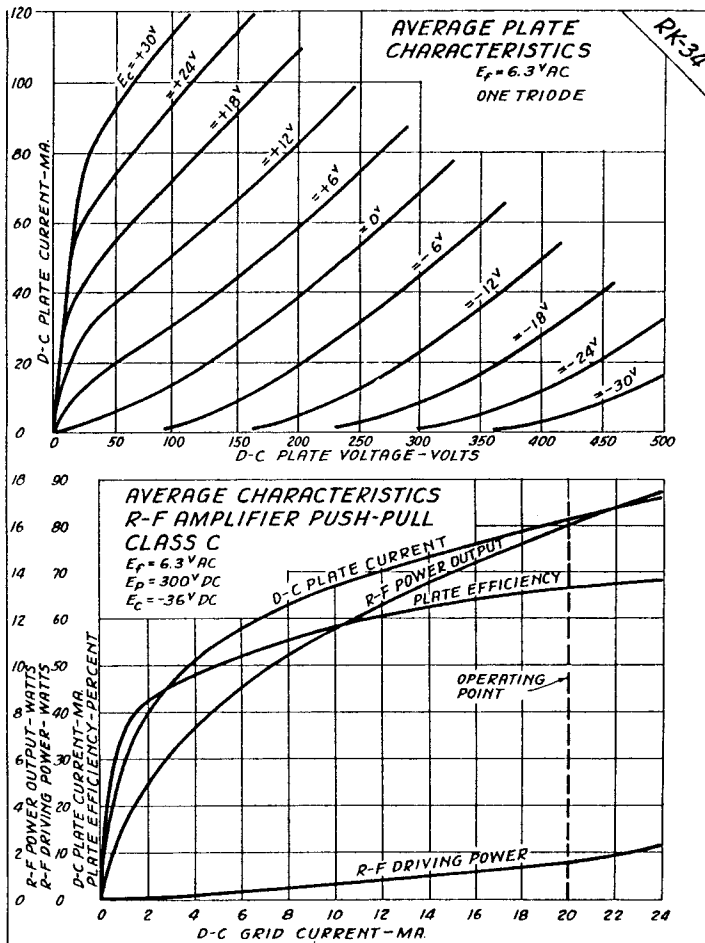

TRIODE POWER AMPLIFIER OSCILLATOR

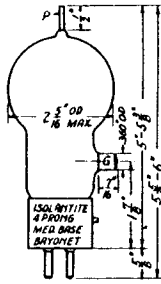

The RK-35 is a triode type power amplifier tube having a tantalum plate and grid and an isolantite base. It is designed for use as a power amplifier, oscillator or frequency multiplier.

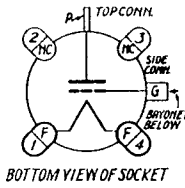

AMPLIFICATION FACTOR 9

FILAMENT RATING

| | | |
|------------------|-----|-------|
| Filament Voltage | 7.5 | volts |
| Filament Current | 4 | amp |

DIRECT INTERELECTRODE CAPACITANCES

| | | |
|---------------|-----|---------|
| Grid to Plate | 2.7 | μ f |
| Input | 3.5 | μ f |
| Output | 0.4 | μ f |

R-F POWER AMPLIFIER OR OSCILLATOR—CLASS C— TELEGRAPHY

MAXIMUM RATINGS

| | | |
|-------------------|------|-------|
| D-C Plate Voltage | 1500 | volts |
| D-C Plate Current | 125 | ma |
| D-C Grid Current | 20 | ma |
| Plate Dissipation | 50 | watts |

TYPICAL OPERATION

| | | |
|------------------------|------|-------|
| D-C Plate Voltage | 1500 | volts |
| D-C Grid Voltage | -250 | volts |
| D-C Plate Current | 115 | ma |
| D-C Grid Current | 15 | ma |
| Peak R-F Input Voltage | 375 | volts |
| R-F Driving Power | 5 | watts |
| Power Output | 120 | watts |

R-F POWER AMPLIFIER—CLASS B—TELEPHONY

MAXIMUM RATINGS

| | | |
|-----------------------------|------|-------|
| D-C Plate Voltage | 1500 | volts |
| D-C Plate Current (Carrier) | 50 | ma |
| Plate Dissipation (Carrier) | 50 | watts |

TYPICAL OPERATION

| | | |
|------------------------|------|-------|
| D-C Plate Voltage | 1500 | volts |
| D-C Grid Voltage | -180 | volts |
| D-C Plate Current | 37 | ma |
| D-C Grid Current | 0 | ma |
| Peak R-F Input Voltage | 280* | volts |
| R-F Driving Power | 2 | watts |
| Carrier Power Output | 25 | watts |
| Peak Power Output | 100* | watts |

R-F POWER AMPLIFIER—CLASS C—TELEPHONY

MAXIMUM RATINGS

| | Grid Modulation | Plate Modulation | |
|-----------------------------|-----------------|------------------|-------|
| D-C Plate Voltage | 1500 | 1250 | volts |
| D-C Plate Current (Carrier) | 50 | 125 | ma |
| Plate Dissipation (Carrier) | 50 | 66 | watts |

TYPICAL OPERATION

| | Grid Modulation | Plate Modulation | |
|-----------------------------|-----------------|------------------|-------|
| D-C Plate Voltage | 1500 | 1250 | volts |
| D-C Grid Voltage | -250 | -250 | volts |
| D-C Plate Current | 50 | 100 | ma |
| D-C Grid Current | 0 | 14 | ma |
| Peak R-F Input Voltage | 230 | 365 | volts |
| R-F Driving Power | 1.7* | 4.6 | watts |
| Carrier Power Output | 25 | 93 | watts |
| Peak A-F Modulating Voltage | 100* | 1250* | volts |
| A-F Modulating Power | 0.3* | 63 | watts |
| Peak Power Output | 100* | 372* | watts |

*At the peak of the a-f cycle with 100% modulation.

OPERATING NOTES

FREQUENCY RANGE

The RK-35 may be operated at the maximum ratings at frequencies up to 60 megacycles. At frequencies between 60 megacycles and 120 megacycles, the maximum d-c plate voltage should not exceed 1000 volts. Above 120 megacycles the maximum d-c plate voltage should not exceed 750 volts.

BIAS

At least 170 volts of fixed bias should be used with 1500 volts on the plate to protect the tube in case of failure of the bias or excitation. The fixed bias may be reduced at lower plate voltages.

PLATE TEMPERATURE

The plate of the RK-35 will show a light yellowish red color (See Plate Temperature Color Scale) when operated at the maximum rated plate dissipation. Dissipations above the rated value should be avoided.

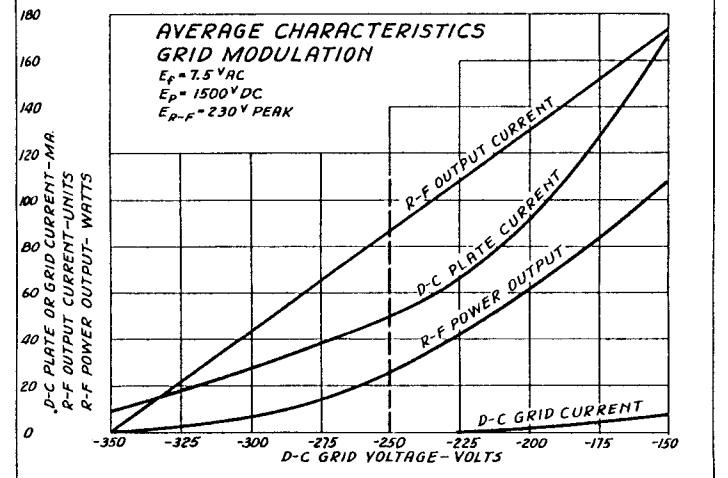
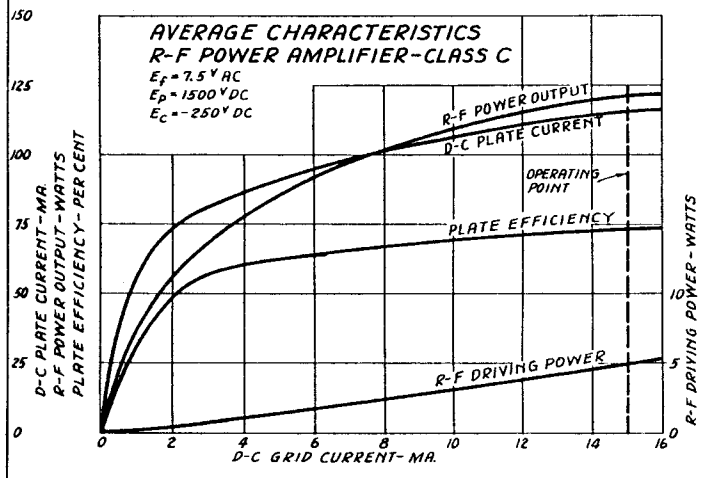
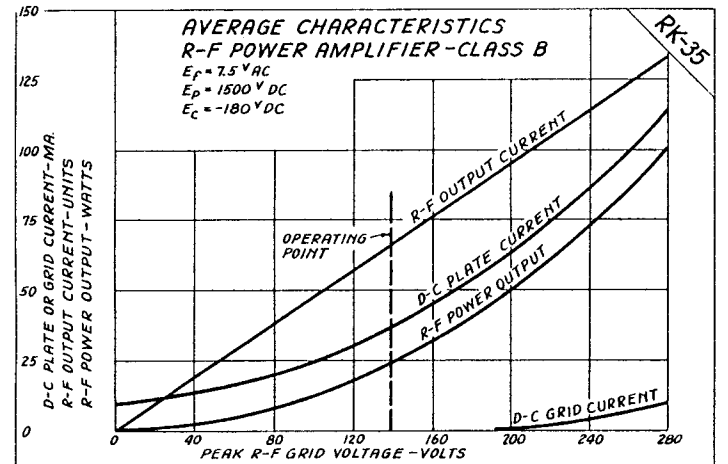
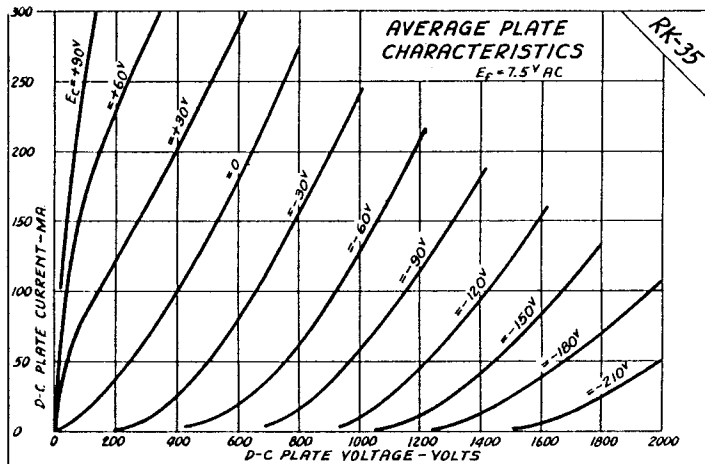

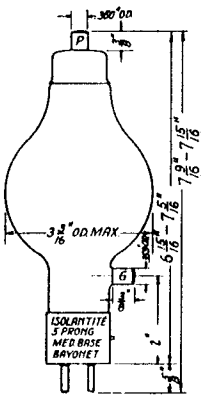

TRIODE POWER AMPLIFIER OSCILLATOR

The RK-36 is a triode type power amplifier tube having a thoriated tungsten filament, a tantalum plate and grid, a hard glass bulb and an isolantite base. It is designed for use as a power amplifier, oscillator or frequency multiplier.

FILAMENT RATING

| | | |
|------------------|-----|-------|
| Filament Voltage | 5.0 | volts |
| Filament Current | 8.0 | amp |

DIRECT INTERELECTRODE CAPACITANCES

| | | |
|---------------|-----|---------------|
| Grid to Plate | 5 | μf |
| Input | 4.5 | μf |
| Output | 1.0 | μf |

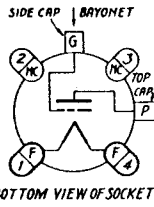

BOTTOM VIEW OF SOCKET

R-F POWER AMPLIFIER OR OSCILLATOR—CLASS C—TELEGRAPHY

MAXIMUM RATINGS

| | | |
|-------------------|------|-------|
| D-C Plate Voltage | 3000 | volts |
| D-C Plate Current | 165 | ma |
| D-C Grid Current | 35 | ma |
| Plate Dissipation | 100 | watts |

TYPICAL OPERATION

| | | |
|------------------------|------|-------|
| D-C Plate Voltage | 2000 | volts |
| D-C Grid Voltage | -360 | volts |
| D-C Plate Current | 150 | ma |
| D-C Grid Current | 30 | ma |
| Peak R-F Input Voltage | 560 | volts |
| R-F Driving Power | 15 | watts |
| Power Output | 200 | watts |

R-F POWER AMPLIFIER—CLASS B—TELEPHONY

MAXIMUM RATINGS

| | | |
|-----------------------------|------|-------|
| D-C Plate Voltage | 3000 | volts |
| D-C Plate Current (Carrier) | 100 | ma |
| Plate Dissipation (Carrier) | 100 | watts |

TYPICAL OPERATION

| | | |
|------------------------|------|-------|
| D-C Plate Voltage | 2000 | volts |
| D-C Grid Voltage | -180 | volts |
| D-C Plate Current | 75 | ma |
| D-C Grid Current | 3 | ma |
| Peak R-F Input Voltage | 420* | volts |
| R-F Driving Power | 10 * | watts |
| Carrier Power Output | 50 | watts |
| Peak Power Output | 200* | watts |

*At the peak of the a-f cycle with 100% modulation.

R-F POWER AMPLIFIER—CLASS C—TELEPHONY

MAXIMUM RATINGS

| | | | |
|-----------------------------|------|------|-------|
| D-C Plate Voltage | 3000 | 2000 | volts |
| D-C Plate Current (Carrier) | 100 | 165 | ma |
| D-C Grid Current (Carrier) | 5 | 35 | ma |
| Plate Dissipation (Carrier) | 100 | 100 | watts |

TYPICAL OPERATION

| | | | |
|-----------------------------|-------|-------|-------|
| D-C Plate Voltage | 2000 | 2000 | volts |
| D-C Grid Voltage | -270 | -360 | volts |
| D-C Plate Current | 72 | 150 | ma |
| D-C Grid Current | 1 | 30 | ma |
| Peak R-F Input Voltage | 315 | 560 | volts |
| R-F Driving Power | 3.5 * | 15 | watts |
| Carrier Power Output | 42 | 200 | watts |
| Peak A-F Modulating Voltage | 110* | 2000* | volts |
| A-F Modulating Power | 1 * | 150 | watts |
| Peak Power Output | 168* | 800 * | watts |

A-F POWER AMPLIFIER—CLASS A

MAXIMUM RATINGS

| | | |
|-------------------|------|-------|
| D-C Plate Voltage | 1500 | volts |
| D-C Plate Current | 165 | ma |
| Plate Dissipation | 100 | watts |

TYPICAL OPERATION

| | | |
|----------------------|-------|------------------|
| D-C Plate Voltage | 1500 | volts |
| D-C Grid Voltage | -77.5 | volts |
| D-C Plate Current | 67 | ma |
| Amplification Factor | 14 | |
| Plate Resistance | 5600 | ohms |
| Transconductance | 2500 | μmhos |
| Load Resistance | 10000 | ohms |
| Power Output | 21 | watts |

*At the peak of the a-f cycle with 100% modulation.

OPERATING NOTES

FREQUENCY RANGE

The construction of the RK-36 allows efficient operation at frequencies up to 60 megacycles. Above 60 megacycles reduced efficiency requires that the plate voltage be reduced to prevent the plate dissipation from exceeding the maximum rated value.

BIAS

At least 150 volts of fixed bias should be used with 2000 volts on the plate to protect the tube in case of failure of the bias or excitation.

PLATE TEMPERATURE

The plate of the RK-36 will show a light yellowish red color (See Plate Temperature Color Scale) when operated at the maximum rated plate dissipation. Dissipations above the rated value should be avoided.

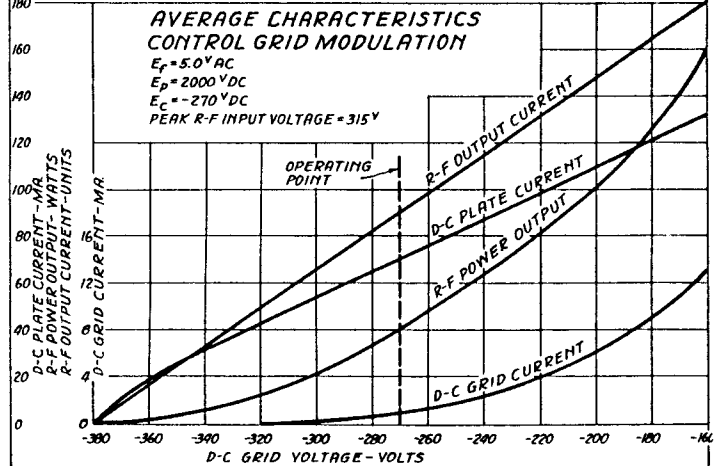
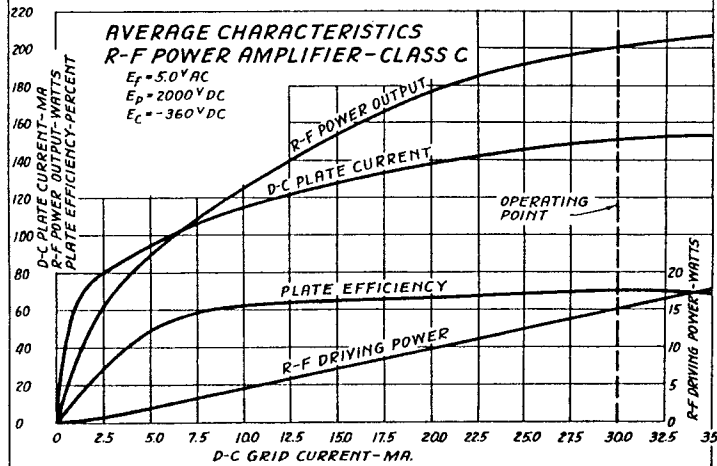
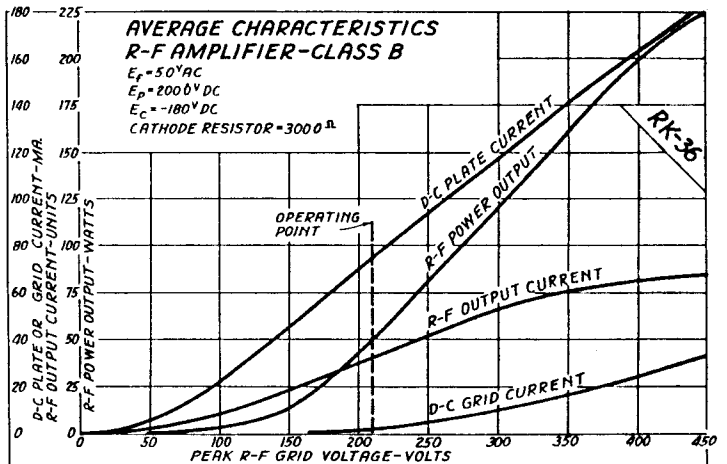
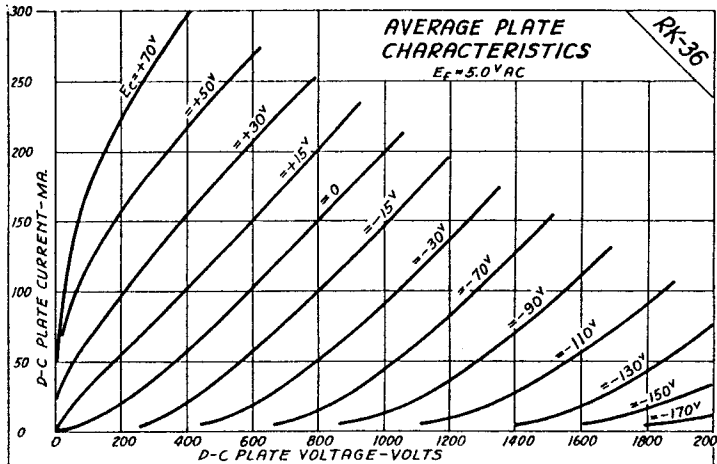

TRIODE POWER AMPLIFIER OSCILLATOR

The RK-37 is a high- μ triode type power amplifier tube having a thoriated tungsten filament, a tantalum plate and grid, a hard glass bulb and an isolantite base. It is designed for use as a power amplifier, oscillator or frequency multiplier.

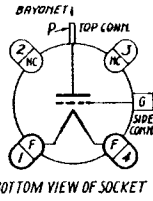

BOTTOM VIEW OF SOCKET

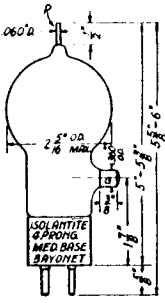

FILAMENT RATING

| | | |
|------------------|-----|-------|
| Filament Voltage | 7.5 | volts |
| Filament Current | 4 | amp |

DIRECT INTERELECTRODE CAPACITANCES

| | | |
|---------------|-----|---------|
| Grid to Plate | 3.2 | μ f |
| Input | 3.5 | μ f |
| Output | 0.2 | μ f |

R-F POWER AMPLIFIER OR OSCILLATOR—CLASS C

MAXIMUM RATINGS

| | | |
|------------------------------|------|-------|
| D-C Plate Voltage—Telegraphy | 1500 | volts |
| D-C Plate Voltage—Telephony | 1500 | volts |
| With Grid Modulation | 1250 | volts |
| With Plate Modulation | 1250 | volts |
| D-C Plate Current | 125 | ma |
| D-C Grid Current | 35 | ma |
| Plate Dissipation | 50 | watts |

TYPICAL OPERATION

| | Telephony Grid Modulation | Telephony Plate Modulation | Telegraphy | |
|------------------------|---------------------------------|----------------------------------|------------|-------|
| D-C Plate Voltage | 1500 | 1250 | 1500 | volts |
| D-C Grid Voltage | -200 | -150 | -130 | volts |
| D-C Plate Current | 44 | 100 | 115 | ma |
| D-C Grid Current | 5 | 23 | 30 | ma |
| Peak R-F Input Voltage | 260 | 270 | 260 | volts |
| R-F Driving Power | 6 * | 5.6 | 7 | watts |
| Carrier Power Output | 26 | 90 | 122 | watts |
| Peak A-F Volt.—Plate | — | 1250* | — | volts |
| Peak A-F Volt.—Grid | 60 * | — | — | volts |
| A-F Modulating Power | 1.4 * | 63 | — | watts |
| Peak Power Output | 104* | 360 * | — | watts |

*At the peak of the a-f cycle with 100% modulation.

R-F POWER AMPLIFIER—CLASS B—TELEPHONY

MAXIMUM RATINGS

| | | |
|-----------------------------|------|-------|
| D-C Plate Voltage | 1500 | volts |
| D-C Plate Current (Carrier) | 50 | ma |
| Plate Dissipation (Carrier) | 50 | watts |

TYPICAL OPERATION

| | | |
|------------------------|-------|-------|
| D-C Plate Voltage | 1500 | volts |
| D-C Grid Voltage | -50 | volts |
| D-C Plate Current | 50 | ma |
| Peak R-F Input Voltage | 120* | volts |
| R-F Driving Power | 2.4 * | watts |
| Carrier Power Output | 26 | watts |
| Peak Power Output | 104* | watts |

A-F POWER AMPLIFIER—CLASS B—TWO TUBES

MAXIMUM RATINGS

| | | |
|------------------------------|------|-------|
| D-C Plate Voltage | 1500 | volts |
| D-C Plate Current (per tube) | 125 | ma |
| Plate Dissipation (per tube) | 50 | watts |

TYPICAL OPERATION

| | | |
|---------------------------------------|-------|-------|
| D-C Plate Voltage | 1250 | volts |
| D-C Grid Voltage | -35 | volts |
| D-C Plate Current (no signal) | 25 | ma |
| D-C Plate Current (max. signal) | 235 | ma |
| D-C Grid Current (max. signal) | 60 | ma |
| Peak A-F Input Voltage (grid to grid) | 282 | volts |
| A-F Driving Power | 7.2 | watts |
| Load Resistance (plate to plate) | 18000 | ohms |
| Power Output | 200 | watts |

*At the peak of the a-f cycle with 100% modulation.

OPERATING NOTES

FREQUENCY RANGE

The RK-37 may be operated at the maximum ratings at frequencies up to 60 megacycles. At frequencies between 60 megacycles and 120 megacycles the maximum d-c plate voltage should not exceed 1000 volts. Above 120 megacycles, the maximum d-c plate voltage should not exceed 750 volts.

BIAS

At least 35 volts of fixed bias should be used with 1500 volts on the plate to protect the tube in case of failure of the bias or excitation. The fixed bias may be reduced at lower plate voltages.

PLATE TEMPERATURE

The plate of the RK-37 will show a light yellowish red color (See Plate Temperature Color Scale) when operated at the maximum rated plate dissipation. Dissipations above the rated value should be avoided.

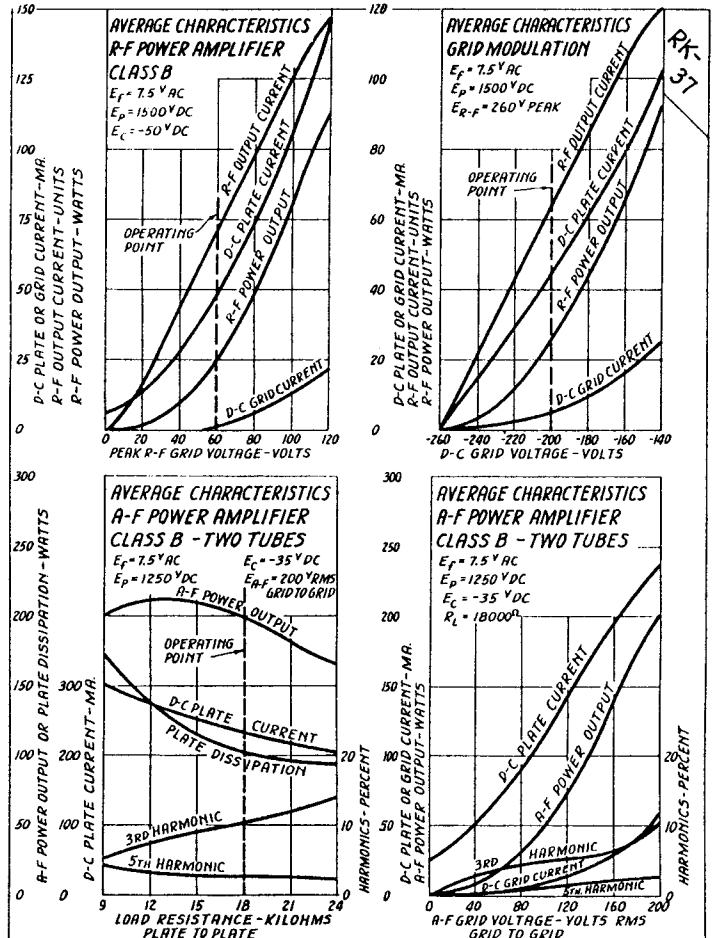
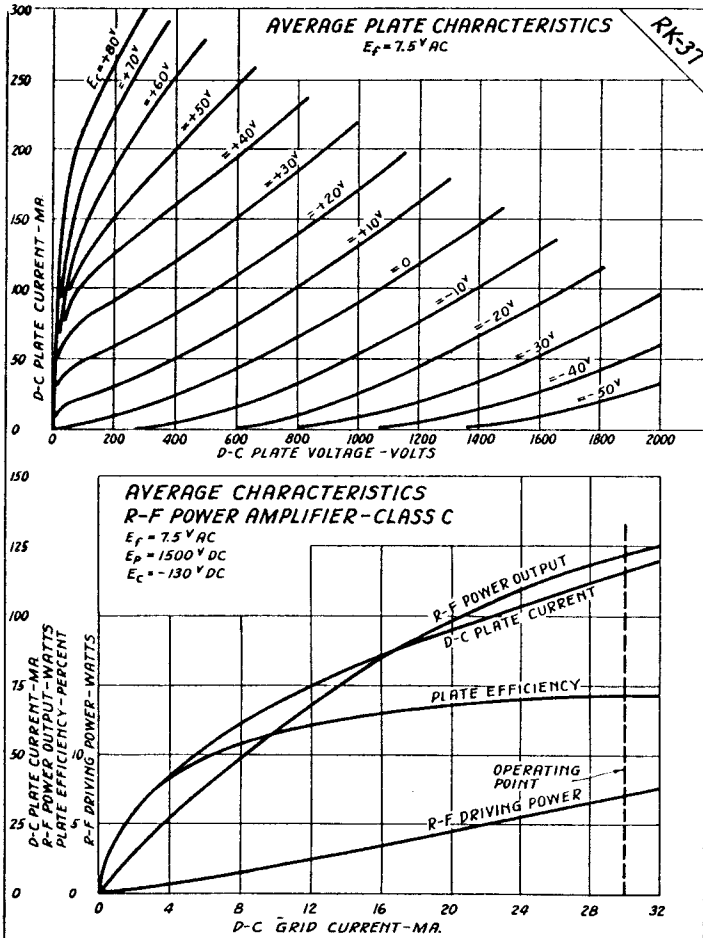

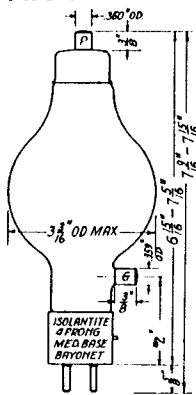

TRIODE POWER AMPLIFIER OSCILLATOR

The RK-38 is a high- μ triode type power amplifier tube having a thoriated tungsten filament, a tantalum plate and grid, a hard glass bulb and an isolantite base. It is designed for use as a power amplifier oscillator, or frequency multiplier.

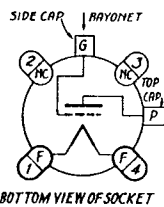

FILAMENT RATING

| | | |
|------------------|---|-------|
| Filament Voltage | 5 | volts |
| Filament Current | 8 | amp |

DIRECT INTERELECTRODE CAPACITANCES

| | | |
|---------------|-----|---------|
| Grid to Plate | 4.3 | μ f |
| Input | 4.6 | μ f |
| Output | 0.9 | μ f |

A-F POWER AMPLIFIER—CLASS B—TWO TUBES

MAXIMUM RATINGS

| | | |
|------------------------------|------|-------|
| D-C Plate Voltage | 3000 | volts |
| D-C Plate Current (per tube) | 165 | ma |
| Plate Dissipation (per tube) | 100 | watts |
| (Averaged over 1 cycle) | | |

TYPICAL OPERATION

| | | |
|--------------------------------------|-------|-------|
| D-C Plate Voltage | 2000 | volts |
| D-C Grid Voltage | -52 | volts |
| D-C Plate Current (no signal) | 36 | ma |
| D-C Plate Current (max. signal) | 265 | ma |
| D-C Grid Current (max. signal) | 39 | ma |
| Peak A-F Grid Voltage (grid to grid) | 357 | volts |
| A-F Driving Power | 5.8 | watts |
| Load Resistance (plate to plate) | 16000 | ohms |
| Power Output | 330 | watts |

R-F POWER AMPLIFIER—CLASS C—TELEGRAPHY

MAXIMUM RATINGS

| | | |
|-------------------|------|-------|
| D-C Plate Voltage | 3000 | volts |
| D-C Plate Current | 165 | ma |
| D-C Grid Current | 40 | ma |
| Plate Dissipation | 100 | watts |

TYPICAL OPERATION

| | | |
|------------------------|------|-------|
| D-C Plate Voltage | 2000 | volts |
| D-C Grid Voltage | -200 | volts |
| D-C Plate Current | 160 | ma |
| D-C Grid Current | 30 | ma |
| Peak R-F Input Voltage | 375 | volts |
| R-F Driving Power | 10 | watts |
| Power Output | 225 | watts |

R-F POWER AMPLIFIER—CLASS B—TELEPHONY

MAXIMUM RATINGS

| | | |
|-----------------------------|------|-------|
| D-C Plate Voltage | 3000 | volts |
| D-C Plate Current (Carrier) | 100 | ma |
| Plate Dissipation (Carrier) | 100 | watts |

TYPICAL OPERATION

| | | |
|------------------------|------|-------|
| D-C Plate Voltage | 2000 | volts |
| D-C Grid Voltage | -100 | volts |
| D-C Plate Current | 75 | ma |
| D-C Grid Current | 2 | ma |
| Peak R-F Input Voltage | 300* | volts |
| R-F Driving Power | 7 * | watts |
| Carrier Power Output | 55 | watts |
| Peak Power Output | 220* | watts |

R-F POWER AMPLIFIER—CLASS C—TELEPHONY

MAXIMUM RATINGS

| | | | |
|-----------------------------|------|------|-------|
| D-C Plate Voltage | 3000 | 2000 | volts |
| D-C Plate Current (Carrier) | 100 | 165 | ma |
| D-C Grid Current (Carrier) | 5 | 40 | ma |
| Plate Dissipation (Carrier) | 100 | 100 | watts |

TYPICAL OPERATION

| | | | |
|-----------------------------|-------|-------|-------|
| D-C Plate Voltage | 2000 | 2000 | volts |
| D-C Grid Voltage | -150 | -200 | volts |
| D-C Plate Current | 80 | 160 | ma |
| D-C Grid Current | 2 | 30 | ma |
| Peak R-F Input Voltage | 220 | 375 | volts |
| R-F Driving Power | 5.5 * | 10 | watts |
| Carrier Power Output | 60 | 225 | watts |
| Peak A-F Modulating Voltage | 100* | 2000* | volts |
| A-F Modulating Power | 1 * | 150 | watts |
| Peak Power Output | 240* | 900 * | watts |

*At the peak of the a-f cycle with 100% modulation.

OPERATING NOTES

FREQUENCY RANGE

The construction of the RK-38 allows efficient operation at frequencies up to 60 megacycles. Above 60 megacycles reduced efficiency requires that the plate voltage be reduced to prevent the plate dissipation from exceeding the maximum rated value.

BIAS

At least 60 volts of fixed bias should be used with 2000 volts on the plate to protect the tube in case of failure of the bias or excitation.

PLATE TEMPERATURE

The plate of the RK-38 will show a light yellowish red color (See Plate Temperature Color Scale) when operated at the maximum rated plate dissipation. Dissipations above the rated value should be avoided.

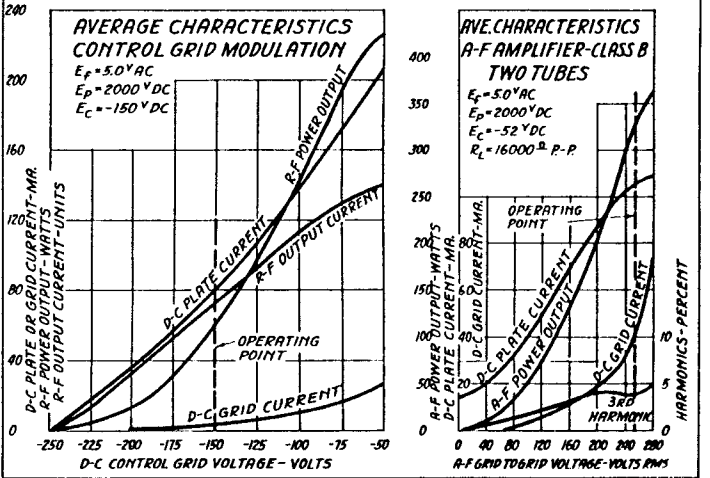
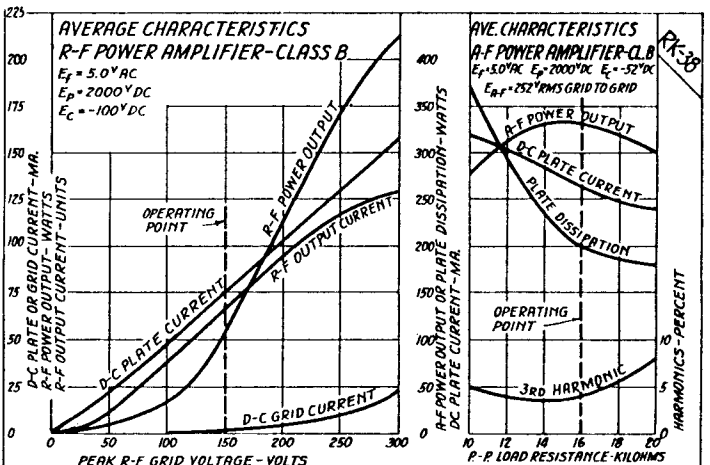
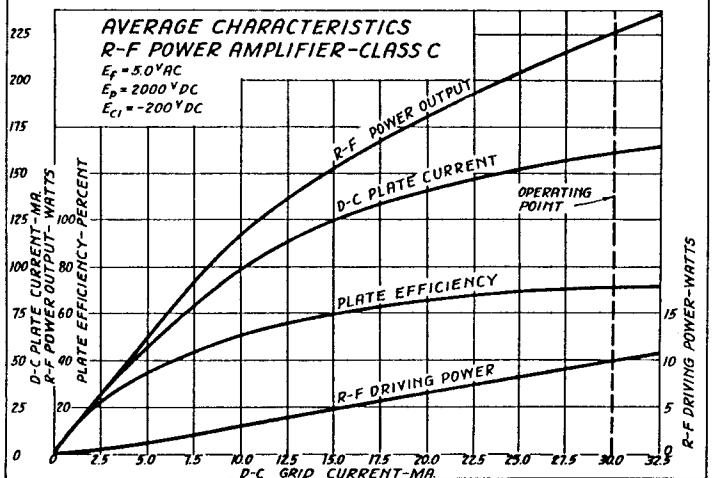
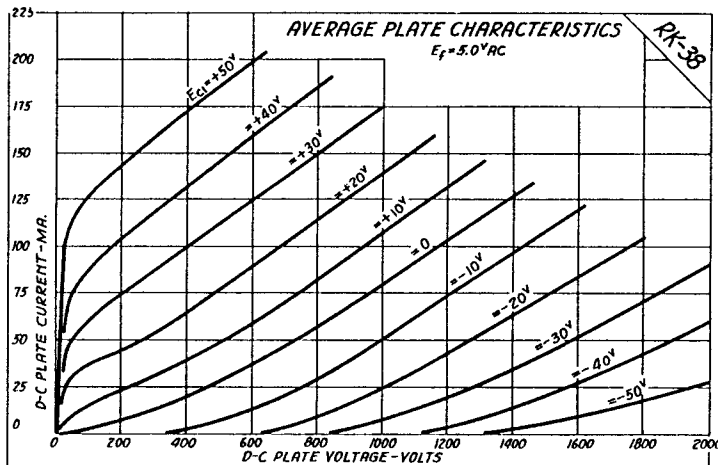

**TETRODE
POWER AMPLIFIER
OSCILLATOR**

The RK-39 and RK-41 are heater type aligned grid beam power amplifier tubes having isolantite bases. The use of aligned grids reduces the ratio of screen current to plate current and allows more efficient utilization of the total space current. The deflector plates in the RK-39 and RK-41 are connected internally to the cathode.

HEATER RATING

| | RK-39 | RK-41 | |
|--------------|-------|-------|-------|
| Heater Volt. | 6.3 | 2.5 | volts |
| Heater Cur. | 0.9 | 2.4 | amp |

DIRECT INTERELECTRODE CAPACITANCES

| | | |
|---------------|-----|----------------|
| Grid to Plate | 0.2 | μmf |
| Input | 13 | μmf |
| Output | 10 | μmf |

R-F POWER AMP. OR OSC.—CLASS C

MAXIMUM RATINGS

| | | |
|----------------------------|-----|-------|
| D-C Plate Volt.—Telegraphy | 600 | volts |
| D-C Plate Volt.—Telephony | 600 | volts |

| | | |
|---|-----|-------|
| With Control Grid Modulation | 600 | volts |
| With Plate or Plate & Screen Modulation | 475 | volts |
| D-C Screen Voltage | 300 | volts |
| D-C Plate Current | 100 | ma |
| D-C Control Grid Current | 5 | ma |
| Plate Dissipation | 25 | watts |
| Screen Dissipation | 3.5 | watts |

TYPICAL OPERATION

| | Telephony Control Grid | Telephony Plate Only | Telephony Plate & Screen | Telephony | | |
|----------------------|------------------------|----------------------|--------------------------|-----------|---------------------|-------------|
| D-C Plate Volt | 500 | 600 | 400 | 475 | 500 600 volts | |
| D-C Screen Volt. | 250 | 300 | 200 | 200 | 250 300 volts | |
| D-C Con. Cd. Vlt. | 50 | -70 | -45 | -45 | -50 -90 volts | |
| D-C Plate Current | 60 | 60 | 65 | 95 | 85 95 93 ma | |
| D-C Screen Current | 3 | 3 | 17.5 | 17.5 | 8 9 12 10 ma | |
| D-C Con. Grid Cur. | 0.6 | 0.2 | 4.0 | 4.0 | 2.5 2.5 3 3 ma | |
| Screen Resistor | — | — | 11400† | 15700† | 19000‡ | 25000‡ ohms |
| Peak R-F Input Vlt. | 60 | 78 | 70 | 70 | 75 75 84 117 volts | |
| R-F Driving Power | 0.5 * | 0.54* | 0.25 | 0.25 | 0.2 0.25 0.38 watts | |
| Carrier Pr. Output | 10 | 12 | 17 | 21 | 25 26 35 36 watts | |
| Peak A-F Vlt., Plate | — | — | 400* | 475* | 400* 475* volts | |
| Peak A-F Vlt., Grid | 25 | * 25 | — | — | 250* 250* volts | |
| A-F Mod. Power | 0.28* | 0.17* | 12 | 16 | 21 20 watts | |
| Peak Pr. Output | 40 * | * 48 * | 68 * | 84 * | 100* 104* watts | |

*At the peak of the a-f cycle with 100% modulation.
†Connected direct to the plate supply voltage and by-passed for r.f. only.
‡Connected to plate end of modulation trans. and by-passed for r.f. only.

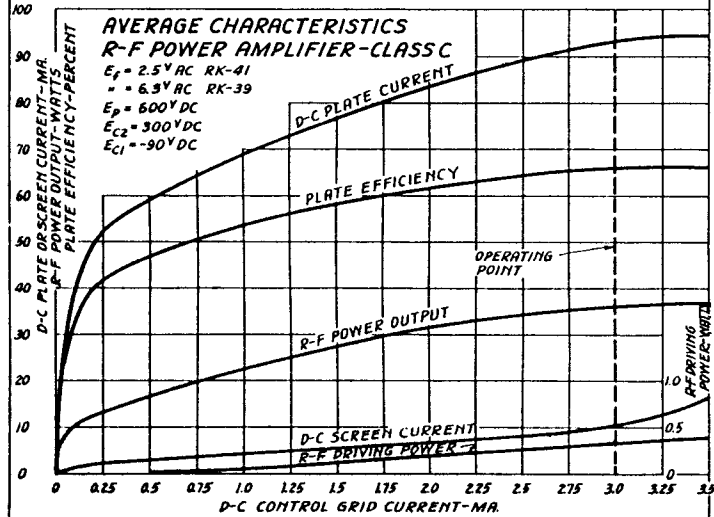
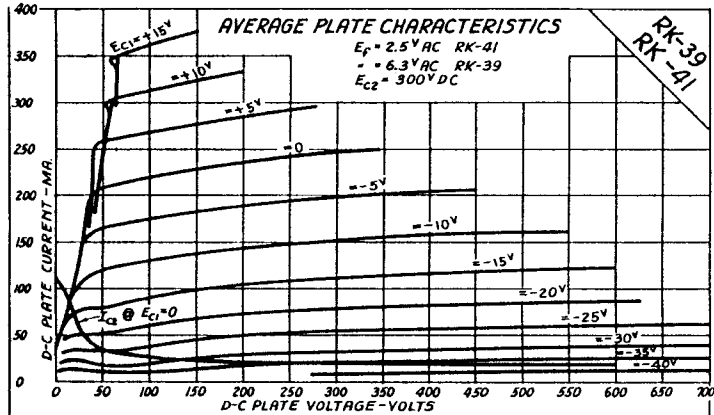

R-F POWER AMPLIFIER—CLASS B—TELEPHONY

MAXIMUM RATINGS

| | | |
|------------------------------|-----|-------|
| D-C Plate Voltage | 600 | volts |
| D-C Screen Voltage | 300 | volts |
| D-C Plate Current (Carrier) | 63 | ma |
| Plate Dissipation (Carrier) | 25 | watts |
| Screen Dissipation (Carrier) | 3.5 | watts |

TYPICAL OPERATION

| | | |
|---------------------------------------|-------|-------|
| D-C Plate Voltage | 600 | volts |
| D-C Screen Voltage | 250 | volts |
| D-C Grid Voltage | -25 | volts |
| D-C Plate Current | 63 | ma |
| D-C Screen Current | 4 | ma |
| D-C Grid Current (at 100% modulation) | 9 | ma |
| Peak R-F Input Voltage | 50 * | watts |
| R-F Driving Power | 0.4 * | watts |
| Carrier Power Output | 12.5* | watts |
| Peak Power Output | 50 * | watts |

*At the peak of the a-f cycle with 100% modulation.

OPERATING NOTES

FREQUENCY RANGE

The RK-39 and RK-41 may be operated at the maximum ratings at frequencies up to 60 megacycles. Above 60 megacycles the reduced efficiency realized requires that the plate voltage be lowered to a maximum of 300 volts to prevent the plate dissipation from exceeding the maximum rated value. The operation of the tubes at frequencies higher than 120 megacycles is not recommended.

EXCITATION

The Class C amplifier characteristic curves show the power output, plate current and screen current plotted vs. excitation as denoted by the d-c control grid current in milliamperes. The power output flattens off around 3 or 4 ma. of grid current with very little gain above these values. The screen dissipation increases with excitation and for this reason the excitation should be kept at a reasonable value.

SHIELDING

Shielding of the grid input tuning system from the plate tuning apparatus is desirable and will provide improved stability. If a shield is applied to the RK-39 or RK-41 it should enclose the base and extend to the lower internal shield and should clear the glass bulb by at least 1/16".

BIAS

At least 25 volts of fixed bias should be used with 600 volts on the plate to protect the tube in case of failure of the bias or excitation. Additional bias may be obtained by the use of a grid or cathode resistor.

CRYSTAL OSCILLATOR

When the RK-39 or RK-41 is used as a crystal controlled oscillator, a 10000 ohm grid leak and a 400 ohm cathode resistor are recommended. At the lower frequencies, it may be necessary to increase the grid to plate capacitance in order to start the oscillator. An additional capacitance of 2 μmf . should be sufficient. Larger values will cause excessive feedback and may damage the crystal.

PLATE TEMPERATURE

The plate of the RK-39 or RK-41 will not show color when operated at the maximum rated plate dissipation. Dissipations above the rated value should be avoided.

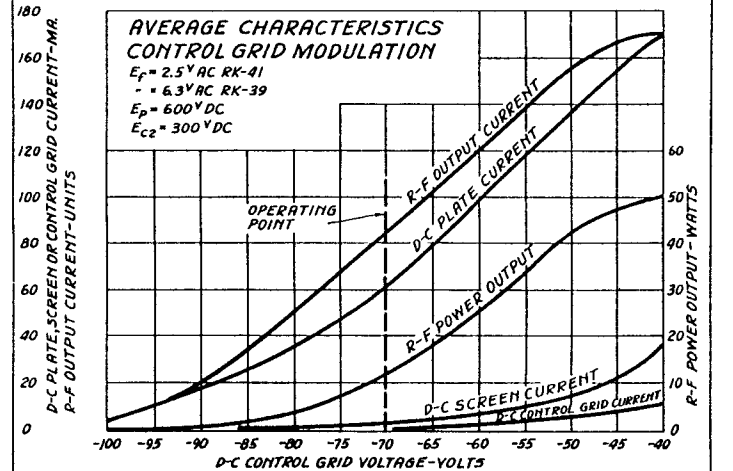
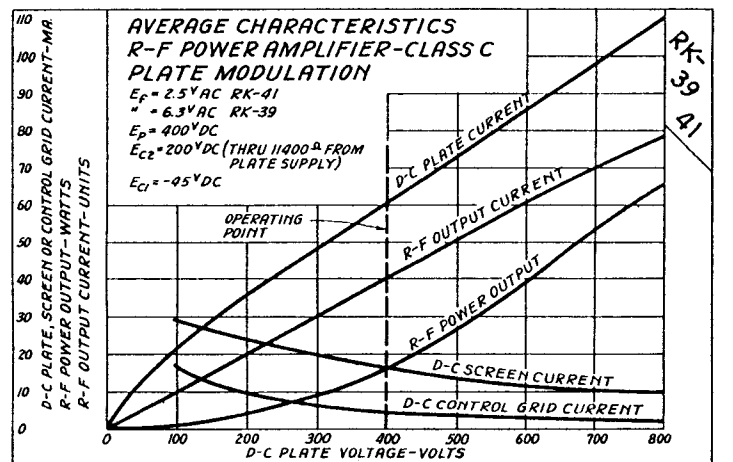

**RK-42
TRIODE
AMPLIFIER
OSCILLATOR**

The RK-42 is a low filament current triode type amplifier tube having an oxide coated filament. It is designed for use in portable equipment with dry cell filament supply.

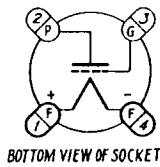
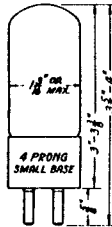

BOTTOM VIEW OF SOCKET

FILAMENT RATING

| | | |
|------------------|------|-------|
| Filament Voltage | 1.5 | volts |
| Filament Current | 0.06 | amp |

DIRECT INTERELECTRODE CAPACITANCES

| | | |
|---------------|-----|------------------|
| Grid to Plate | 6 | $\mu\mu\text{f}$ |
| Input | 3 | $\mu\mu\text{f}$ |
| Output | 2.1 | $\mu\mu\text{f}$ |

**A-F AMPLIFIER—CLASS A
MAXIMUM RATINGS**

| | | |
|-------------------|-----|-------|
| D-C Plate Voltage | 180 | volts |
| D-C Plate Current | 7.5 | ma |

TYPICAL OPERATION

| | | |
|----------------------|-------|------------------|
| D-C Plate Voltage | 180 | volts |
| D-C Grid Voltage | -13.5 | volts |
| D-C Plate Current | 3.9 | ma |
| Amplification Factor | 8.2 | |
| Plate Resistance | 10300 | ohms |
| Transconductance | 800 | μmhos |

**TWIN TRIODE
POWER AMPLIFIER
OSCILLATOR**

The RK-43 is a low filament current twin triode type amplifier tube having an oxide coated filament. It is designed for use in portable equipment with dry cell filament supply.

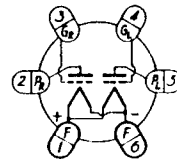

BOTTOM VIEW OF SOCKET

FILAMENT RATING

| | | |
|----------------|------|-------|
| Filament Volt. | 1.5 | volts |
| Filament Cur. | 0.12 | amp |

**DIRECT INTERELECTRODE CAPACITANCES
—EACH TRIODE**

| | | |
|---------------|-----|------------------|
| Grid to Plate | 4.2 | $\mu\mu\text{f}$ |
| Input | 1.9 | $\mu\mu\text{f}$ |
| Output | 2.1 | $\mu\mu\text{f}$ |

A-F AMPLIFIER—CLASS A—ONE TRIODE

| | | |
|----------------------|----------|------------------|
| D-C Plate Voltage | 135 max. | volts |
| D-C Grid Voltage | -4.5 | volts |
| D-C Plate Current | 3 | ma |
| Amplification Factor | 13 | |
| Plate Resistance | 14500 | ohms |
| Transconductance | 900 | μmhos |

**A-F POWER AMPLIFIER—CLASS B
MAXIMUM RATINGS**

| | | |
|--|-----|-------|
| D-C Plate Voltage | 135 | volts |
| D-C Plate Current (Average—both triodes) | 15 | ma |

TYPICAL OPERATION

| | | |
|---------------------------------------|-------|-------|
| D-C Plate Voltage | 135 | volts |
| D-C Grid Voltage | -6 | volts |
| D-C Plate Current (no signal) | 4 | ma |
| D-C Plate Current (max. signal) | 12.5 | ma |
| D-C Grid Current | 1 | ma |
| Peak A-F Input Voltage (grid to grid) | 24 | volts |
| A-F Driving Power | 27.5 | mw |
| Load Resistance (plate to plate) | 24000 | ohms |
| Power Output | 0.95 | watt |

**R-F AMPLIFIER OR OSCILLATOR—CLASS C—PUSH-PULL
MAXIMUM RATINGS**

| | | |
|--|-----|-------|
| D-C Plate Voltage | 135 | volts |
| D-C Plate Current (Average—both triodes) | 15 | ma |

TYPICAL OPERATION

| | | |
|---------------------------------------|------|-------|
| D-C Plate Voltage | 135 | volts |
| D-C Grid Voltage | -20 | volts |
| D-C Plate Current | 14 | ma |
| D-C Grid Current | 3 | ma |
| Peak R-F Input Voltage (grid to grid) | 70 | volts |
| R-F Driving Power | 0.2 | watts |
| Power Output | 1.25 | watts |

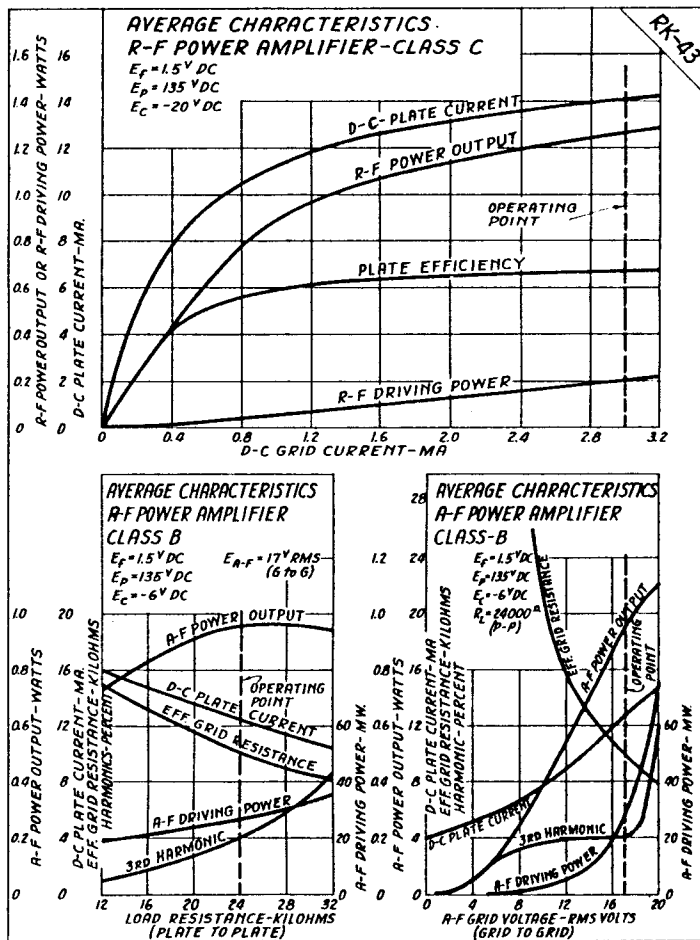
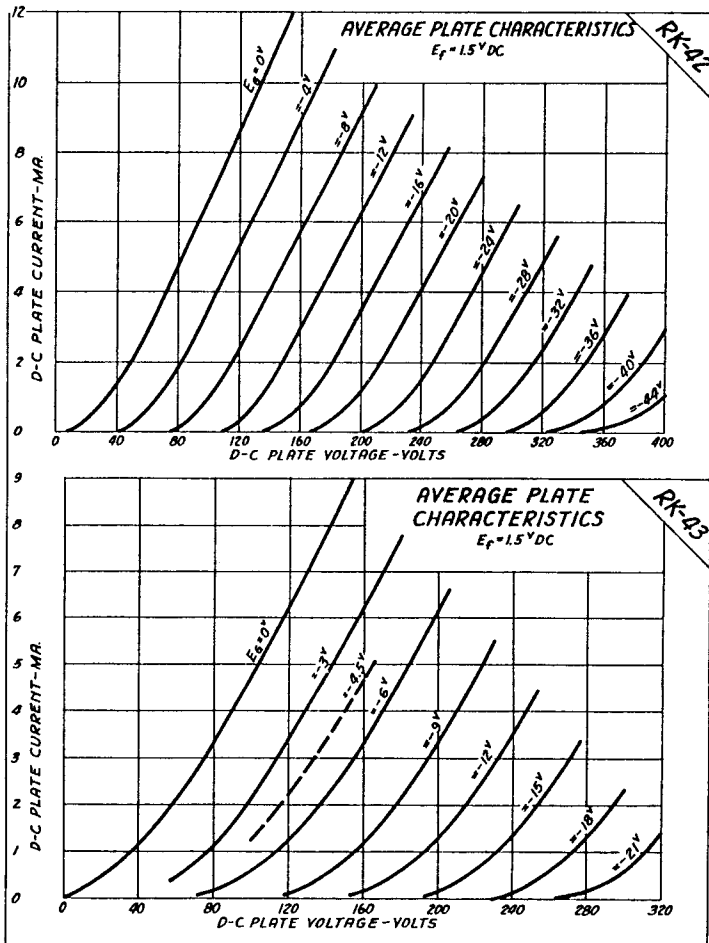

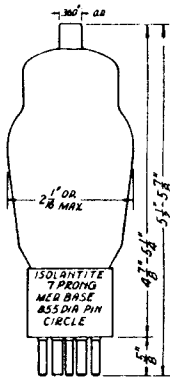

PENTODE POWER AMPLIFIER OSCILLATOR

The RK-44 is a heater type pentode power amplifier having an isolantite base. It is designed for use as a power amplifier, oscillator or frequency multiplier. The RK-44 may also be used in circuits employing suppressor or control grid modulation.

HEATER RATING

| | | |
|----------------|------|-------|
| Heater Voltage | 12.6 | volts |
| Heater Current | 0.7 | amp |

DIRECT INTERELECTRODE CAPACITANCES

| | | |
|---------------|-----|---------------|
| Grid to Plate | 0.2 | μF |
| Input | 16 | μF |
| Output | 10 | μF |

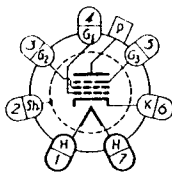

BOTTOM VIEW OF SOCKET

R-F POWER AMPLIFIER—CLASS B—TELEPHONY

MAXIMUM RATINGS

| | | |
|------------------------------|-----|-------|
| D-C Plate Voltage | 500 | volts |
| D-C Screen Voltage | 200 | volts |
| D-C Plate Current (Carrier) | 40 | ma |
| Plate Dissipation (Carrier) | 12 | watts |
| Screen Dissipation (Carrier) | 5 | watts |

TYPICAL OPERATION

| | | | |
|-----------------------------|------|------|-------|
| D-C Plate Voltage | 500 | 500 | volts |
| D-C Screen Voltage | 200 | 200 | volts |
| D-C Suppressor Grid Voltage | 0 | +40 | volts |
| D-C Control Grid Voltage | -25 | -25 | volts |
| D-C Plate Current | 30 | 30 | ma |
| D-C Screen Current | 15 | 12 | ma |
| Peak R-F Input Voltage | 50* | 48* | volts |
| R-F Driving Power | 0.2* | 0.1* | watts |
| Carrier Power Output | 5 | 5.5 | watts |
| Peak Power Output | 20* | 22* | watts |

*At the peak of the a-f cycle with 100% modulation.

R-F POWER AMPLIFIER OR OSCILLATOR—CLASS C

MAXIMUM RATINGS

| | | |
|--|-----|-------|
| D-C Plate Voltage—Telephony | 500 | volts |
| D-C Plate Voltage—Telephony With Control or Suppressor Grid Modulation | 500 | volts |
| D-C Plate Voltage—Telephony With Plate & Screen Modulation | 400 | volts |
| D-C Screen Voltage | 200 | volts |
| D-C Plate Current | 80 | ma |
| D-C Control Grid Current | 8 | ma |
| Plate Dissipation | 12 | watts |
| Screen Dissipation | 8 | watts |

TYPICAL OPERATION

| | Telephony Con. Grid Modulation | Telephony Supp. Grid Modulation | Telephony Plate & Scr. Modulation | Telephony | Telephony | |
|-----------------------|--------------------------------|---------------------------------|-----------------------------------|-----------|-----------|-----|
| D-C Plate Voltage | 500 | 500 | 500 | 400 | 500 | 500 |
| D-C Screen Voltage | 200 | 200 | 180 | 140 | 200 | 200 |
| D-C Sup. Grid Volt. | 0 | +40 | -65 | +40 | 0 | +40 |
| D-C Con. Grid Volt. | -45 | -43 | -20 | -40 | -85 | -75 |
| D-C Plate Current | 30 | 30 | 30 | 45 | 60 | 60 |
| D-C Screen Current | 7 | 6 | 23 | 20 | 30 | 15 |
| D-C Con. Grid Current | 0.1 | 0.1 | 3.5 | 5 | 8 | 4 |
| Screen Resistor | — | — | 14000† | 13000‡ | — | — |
| Peak R-F Input Volt. | 48 | 44 | 32 | 60 | 120 | 100 |
| R-F Driving Power | 0.2* | 0.15* | 0.1 | 0.3 | 0.8 | 0.4 |
| Carrier Power Output | 5 | 5.5 | 5 | 11 | 20 | 22 |
| Peak A-F Volt.—Plate | — | — | — | 400* | — | — |
| Peak A-F Volt.—Grid | 20* | 18* | 65* | 140* | — | — |
| A-F Modulating Power | 0.1* | 0.06* | 0 | 13 | — | — |
| Peak Power Output | 20* | 22* | 20* | 44* | — | — |

*At the peak of the a-f cycle with 100% modulation.
 †Connected direct to plate supply voltage and by-passed for r.f. only.
 ‡Connected to plate end of modulation trans. and by-passed for r.f. only.

OPERATING NOTES

FREQUENCY RANGE

The RK-44 may be operated at the maximum ratings at frequencies up to 20 megacycles. Above 20 megacycles the reduced efficiency realized requires that the plate voltage be lowered to prevent the plate dissipation from exceeding the maximum rated value.

SCREEN SUPPLY

The screen voltage may be obtained either from a voltage divider or through a series resistor from the plate supply. The screen should always be by-passed to the cathode for r.f.

SHIELDING

The internal shield in the RK-44 is connected to base pin #2 and normally should be connected to the cathode pin #6. Shielding of the grid input tuning system from the plate tuning apparatus is desirable and will provide improved stability. If a shield is applied to the RK-44 it should enclose the base and extend to the lower internal shield and should clear the glass bulb by at least 1/16".

BIAS

At least 15 volts of fixed bias should be used with 500 volts on the plate to protect the tube in case of failure of the bias or excitation. Additional bias may be obtained by the use of a grid or cathode resistor.

CRYSTAL OSCILLATOR

Using crystal control, 20 watts of r-f power output may be obtained without overheating the crystal.

PLATE TEMPERATURE

The plate of the RK-44 will not show color when operated at the maximum rated dissipation. Dissipations above the rated value should be avoided.

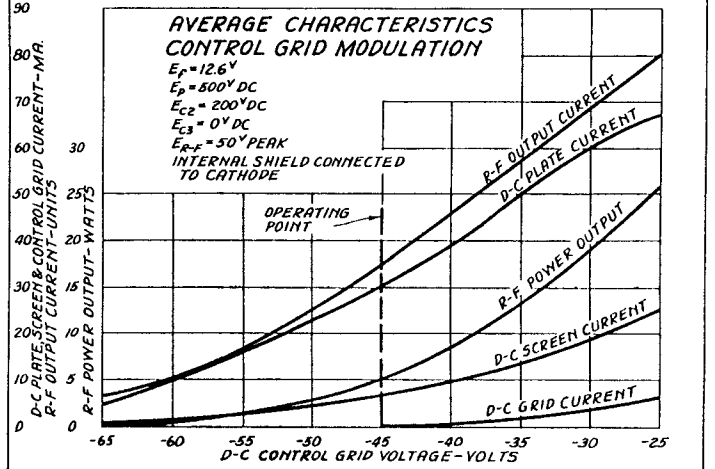
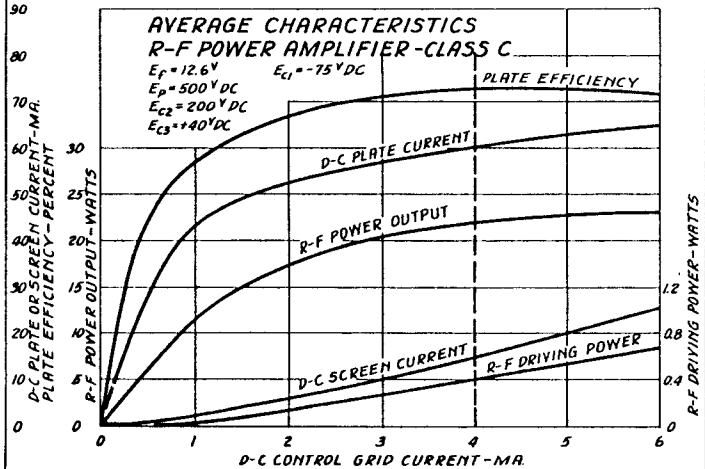
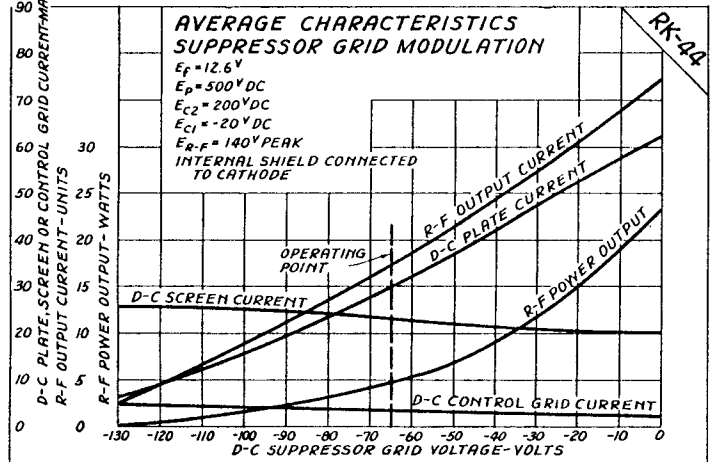
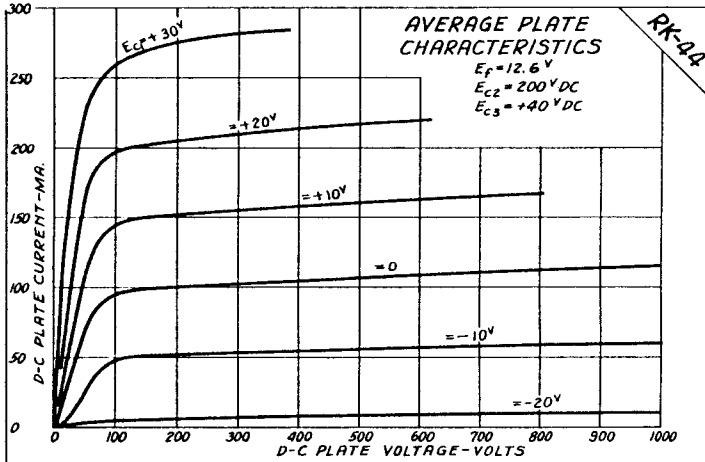

**PENTODE
POWER AMPLIFIER
OSCILLATOR**

The RK-45 is a heater type pentode power amplifier tube having an isolantite base. It is designed for use as a power amplifier, oscillator or frequency multiplier. The RK-45 may also be used in circuits employing suppressor or control grid modulation.

HEATER RATING

Heater Voltage 12.6 volts
Heater Current 0.45 amp

DIRECT INTERELECTRODE CAPACITANCES

Grid to Plate 0.02 $\mu\mu\text{f}$
Input 10 $\mu\mu\text{f}$
Output 10 $\mu\mu\text{f}$

**R-F POWER AMPLIFIER OR OSCILLATOR—
CLASS C**

MAXIMUM RATINGS
D-C Plate Voltage—Telegraphy 500 volts
D-C Plate Voltage—Telephony
With Control or Sup. Grid
Modulation 500 volts
With Plate & Screen Mod. 400 volts
D-C Screen Voltage 250 volts
D-C Plate Current 60 ma
D-C Control Grid Current 10 ma
Plate Dissipation 10 watts
Screen Dissipation 8 watts

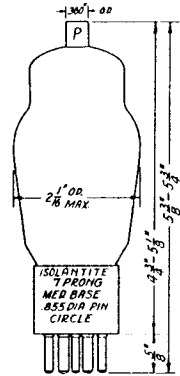
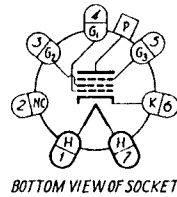

**PENTODE
POWER AMPLIFIER
OSCILLATOR**

The RK-46 is a pentode tube having a thoriated tungsten filament, a molybdenum plate, a hard glass bulb and an isolantite base. It is designed for use as a power amplifier, oscillator or frequency multiplier. The RK-46 may also be used in circuits employing suppressor or control grid modulation.

FILAMENT RATING

Filament Volt. 12.6 volts
Filament Cur. 2.5 amp

DIRECT INTERELECTRODE CAPACITANCES

Grid to Plate 0.1 $\mu\mu\text{f}$
Input 14 $\mu\mu\text{f}$
Output 12 $\mu\mu\text{f}$

**R-F POWER AMPLIFIER OR OSCILLATOR—
CLASS C**

MAXIMUM RATINGS
D-C Plate Voltage—Telegraphy 1250 volts
D-C Plate Voltage—Telephony
With Control or Sup. Grid
Modulation 1250 volts
With Plate & Screen Mod. 1000 volts
D-C Screen Voltage 300 volts
D-C Plate Current 92 ma
D-C Control Grid Current 15 ma
R-F Control Grid Current 5 amp
Plate Dissipation 40 watts
Screen Dissipation 15 watts

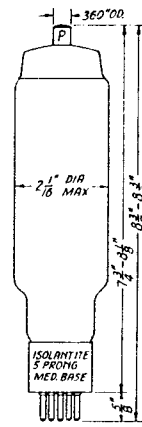
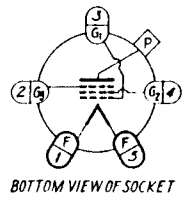

TYPICAL OPERATION

| | Telephony Control Grid Modulation | Telephony Suppressor Grid Modulation | Telephony Plate & Screen Modulation | Telephony | Telephony | |
|-----------------------|--|---|--|-----------------|-----------|-----------|
| D-C Plate Voltage | 500 | 500 | 500 | 400 | 500 | 500 volts |
| D-C Screen Voltage | 200 | 200 | 200 | 150 | 200 | 200 volts |
| D-C Sup. Grid Voltage | 0 | +45 | -45 | 0 | +45 | volts |
| D-C Con. Grid Volt. | -125 | -125 | -90 | -90 | -90 | volts |
| D-C Plate Current | 32 | 34 | 31 | 43 | 50 | 55 ma |
| D-C Screen Current | 20 | 20 | 39 | 30 | 40 | 38 ma |
| D-C Con. Grid Current | 1.5 | 1.5 | 4 | 6 | 4 | 4 ma |
| Screen Resistor | | | | 8300 \ddagger | | ohms |
| Peak R-F Input Volt. | 150 | 150 | 135 | 145 | 135 | 135 volts |
| R-F Driving Power | 1.2* | 1.3 * | 0.5 | 0.8 | 0.5 | 0.5 watts |
| Carrier Power Output | 5.5 | 6.5 | 6 | 13.5 | 18 | 22 watts |
| Peak A-F Volt.—Plate | | | | 400 * | | volts |
| Peak A-F Volt.—Grid | 45 * | 45 * | 75 * | 150 * | | volts |
| A-F Modulating Power | 0.5* | 0.55* | 0.3* | 1.5 | | watts |
| Peak Power Output | 22 * | 26 * | 24 * | 54 * | | watts |

R-F POWER AMPLIFIER—CLASS B—TELEPHONY

MAXIMUM RATINGS

D-C Plate Voltage 500 volts
D-C Screen Voltage 250 volts
D-C Plate Current (Carrier) 35 ma
Plate Dissipation (Carrier) 10 watts
Screen Dissipation (Carrier) 8 watts

TYPICAL OPERATION

D-C Plate Voltage 500 volts
D-C Screen Voltage 200 volts
D-C Suppressor Grid Voltage 0 volts
D-C Control Grid Voltage -38 volts
D-C Plate Current 30 ma
D-C Screen Current 12 ma
Peak R-F Input Voltage 80 * volts
R-F Driving Power 0.24* watts
Carrier Power Output 5 watts
Peak Power Output 20 * watts

*At the peak of the a-f cycle with 100% modulation.
‡Connected to plate end of modulation trans. and by-passed for r.f. only.

OPERATING NOTES

CHARACTERISTIC CURVES

For average characteristic curves refer to the type RK-25. The characteristics of the RK-45 and RK-25 are the same except for the heater rating.

FREQUENCY RANGE

The RK-45 may be operated at the maximum ratings at frequencies up to 30 megacycles. Above 30 megacycles the reduced efficiency realized requires that the plate voltage be lowered to prevent the plate dissipation from exceeding the maximum rated value.

EXCITATION

The Class C amplifier characteristic curves show the power output, plate current and screen current plotted vs. excitation as denoted by the d-c control grid current in milliamperes. The power output flattens off around 4 or 5 ma. of grid current with very little gained beyond these values. The screen dissipation increases with excitation and for this reason the excitation should be kept at a reasonable value.

SHIELDING

Shielding of the grid input tuning system from the plate tuning apparatus is desirable and will provide improved stability. If a shield is applied to the RK-45 it should enclose the base and extend to the lower internal shield and should clear the glass bulb by at least 1/16".

BIAS

At least 25 volts of fixed bias should be used with 500 volts on the plate to protect the tube in case of failure of the bias or excitation. Additional bias may be obtained by the use of a grid or cathode resistor.

CRYSTAL OSCILLATOR

Using crystal control, 20 watts of r-f power output may be obtained without overheating the crystal.

PLATE TEMPERATURE

The plate of the RK-45 will not show color when operated at the rated plate dissipation. Dissipations above the rated value should be avoided.

TYPICAL OPERATION

| | Telephony Control Grid Modulation | Telephony Suppressor Grid Modulation | Telephony Plate & Screen Modulation | Telephony | Telephony | |
|-----------------------|--|---|--|------------------|-----------|------------|
| D-C Plate Voltage | 1250 | 1250 | 1250 | 1000 | 1250 | 1250 volts |
| D-C Screen Voltage | 300 | 300 | 300 | 300 | 300 | 300 volts |
| D-C Sup. Grid Volt. | 0 | +45 | -45 | 0 | +45 | volts |
| D-C Con. Grid Volt. | -142 | -142 | -100 | -100 | -100 | volts |
| D-C Plate Current | 40 | 40 | 48 | 75 | 80 | 92 ma |
| D-C Screen Current | 7 | 7 | 44 | 30 | 43 | 36 ma |
| D-C Con. Grid Current | 1.8 | 1.8 | 11.5 | 10 | 11.5 | 11.6 ma |
| Screen Resistor | | | | 23000 \ddagger | | ohms |
| Peak R-F Input Volt. | 160 | 160 | 140 | 145 | 155 | 155 volts |
| R-F Driving Power | 1.5* | 1.5* | 1.5 | 1.3 | 1.6 | 1.6 watts |
| Carrier Power Output | 17 | 20 | 21 | 52 | 64 | 84 watts |
| Peak A-F Volt.—Plate | | | | 1000* | | volts |
| Peak A-F Volt.—Grid | 30 * | 30 * | 75 * | 300 * | | volts |
| A-F Modulating Power | 0.3* | 0.3* | 0.36* | 52 | | watts |
| Peak Power Output | 68 * | 80 * | 84 * | 208 * | | watts |

R-F POWER AMPLIFIER—CLASS B—TELEPHONY

MAXIMUM RATINGS

D-C Plate Voltage 1250 volts
D-C Screen Voltage 300 volts
D-C Plate Current (Carrier) 70 ma
Plate Dissipation (Carrier) 40 watts
Screen Dissipation (Carrier) 15 watts

TYPICAL OPERATION

D-C Plate Voltage 1250 volts
D-C Screen Voltage 300 volts
D-C Suppressor Grid Voltage 0 volts
D-C Grid Voltage -30 volts
D-C Plate Current 43 ma
D-C Screen Current 15 ma
Peak R-F Input Voltage 70 * volts
R-F Driving Power 0.5* watts
Carrier Power Output 16 watts
Peak Power Output 64 * watts

*At the peak of the a-f cycle with 100% modulation.
‡Connected to plate end of modulation trans. and by-passed for r.f. only.

OPERATING NOTES

CHARACTERISTIC CURVES

For average characteristic curves refer to the type RK-20A. The characteristics of the RK-46 and RK-20A are the same except for the filament rating.

FREQUENCY RANGE

The RK-46 may be operated at the maximum ratings at frequencies up to 30 megacycles. At frequencies between 30 megacycles and 60 megacycles the maximum d-c plate voltage should not exceed 900 volts. The operation of the tube at frequencies higher than 60 megacycles is not recommended.

EXCITATION

The Class C amplifier characteristic curves show the power output, plate current and screen current plotted vs. excitation as denoted by the control grid current in milliamperes. The power output flattens off around 11 or 12 ma. of grid current with very little gained beyond these values. The screen dissipation increases with excitation and for this reason the excitation should be kept at a reasonable value.

SHIELDING

Shielding of the grid input tuning system from the plate tuning apparatus is desirable and will provide improved stability. If a shield is applied to the RK-46 it should enclose the base and extend to the lower internal shield and should clear the glass bulb by at least 1/16".

BIAS

Battery bias, or at least partial battery bias on the control grid is recommended. Additional bias may be obtained by placing a resistor in series with the battery.

CRYSTAL OSCILLATOR

Using crystal control, 50 watts of r-f power output may be obtained without overheating the crystal.

PLATE TEMPERATURE

The plate of the RK-46 will not show color when operated at the rated plate dissipation. Dissipations above the rated value should be avoided.

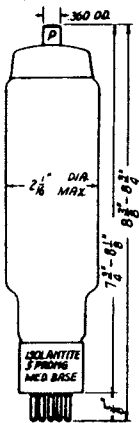

TETRODE POWER AMPLIFIER OSCILLATOR

The RK-47 is a beam type aligned grid tetrode having a thoriated tungsten filament, a hard glass bulb and an isolantite base. The use of aligned grids reduces the ratio of screen current to plate current and allows more efficient utilization of the total space current. The deflector plates in the RK-47 are connected to base pin #4 which should be connected to the filament center-tap.

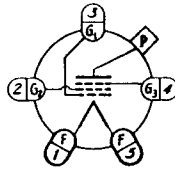

BOTTOM VIEW OF SOCKET

FILAMENT RATING

| | | |
|------------------|------|-------|
| Filament Voltage | 10 | volts |
| Filament Current | 3.25 | amp |

DIRECT INTERELECTRODE CAPACITANCES

| | | |
|---------------|------|-----|
| Grid to Plate | 0.12 | MMF |
| Input | 13 | MMF |
| Output | 10 | MMF |

R-F POWER AMP. OR OSC.—CLASS C

MAXIMUM RATINGS

| | | |
|--|------|-------|
| D-C Plate Voltage—Telephony | 1250 | volts |
| D-C Plate Voltage—Telephony With Control Grid Modulation | 1250 | volts |
| With Plate or Plate & Screen Modulation | 900 | volts |
| D-C Screen Voltage | 300 | volts |
| D-C Plate Current | 150 | ma |
| D-C Control Grid Current | 10 | ma |
| R-F Control Grid Current | 5 | amp |
| Plate Dissipation | 50 | watts |
| Screen Dissipation | 10# | watts |

TYPICAL OPERATION

| | Telephony Control Grid Modulation | Telephony Plate Only Modulation | Telephony Plate & Screen Modulation | Telephony | |
|--------------------------|-----------------------------------|---------------------------------|-------------------------------------|-----------|-------|
| D-C Plate Voltage | 1250 | 900 | 900 | 1250 | volts |
| D-C Screen Voltage | 300 | 300 | 300 | 300 | volts |
| D-C Control Grid Voltage | -135 | -100 | -120 | -70 | volts |
| D-C Plate Current | 60 | 80 | 90 | 138 | ma |
| D-C Screen Current | 9 | 50 | 23 | 14 | ma |
| D-C Con. Grid Current | 1.6 | 10 | 7.5 | 7 | ma |
| Screen Resistor | — | 12000† | 28000‡ | — | ohms |
| Peak R-F Input Voltage | 155 | 160 | 180 | 160 | volts |
| R-F Driving Power | 1.43* | 1.5 | 1.2 | 1.0 | watts |
| Carrier Power Output | 28.5 | 50 | 55 | 120 | watts |
| Peak A-F Volt.—Plate | — | 900* | 900* | — | volts |
| Peak A-F Volt.—Grid | 40 * | — | 250* | — | volts |
| A-F Modulating Power | 0.37* | 36 | 51 | — | watts |
| Peak Power Output | 114 * | 200* | 220* | — | watts |

#15 watts allowable if average plate dissipation does not exceed 40 watts.
 *At the peak of the a-f cycle with 100% modulation.
 †Connected direct to plate supply voltage and by-passed for r.f. only.
 ‡Connected to plate end of modulation trans. and by-passed for r.f. only.

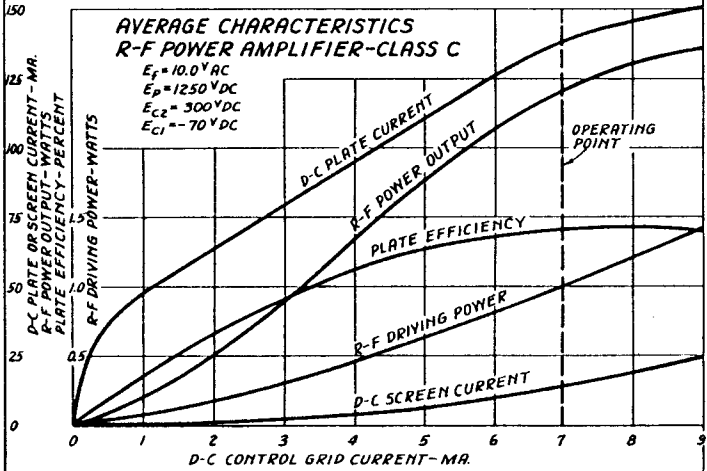
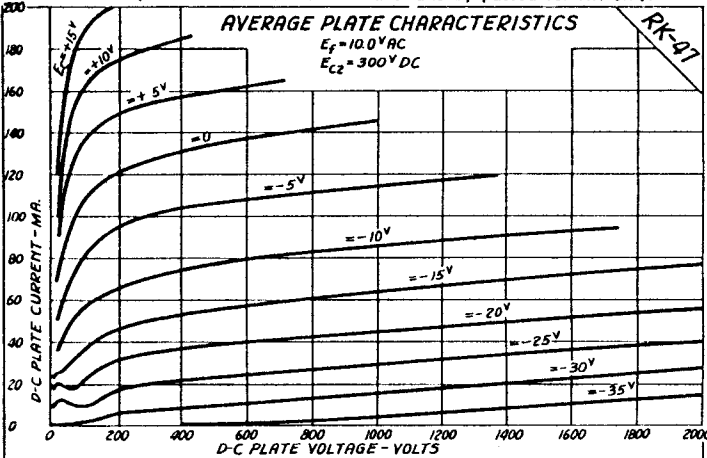

R-F POWER AMPLIFIER—CLASS B—TELEPHONY

MAXIMUM RATINGS

| | | |
|------------------------------|------|-------|
| D-C Plate Voltage | 1250 | volts |
| D-C Screen Voltage | 300 | volts |
| D-C Plate Current (Carrier) | 75 | ma |
| Plate Dissipation (Carrier) | 50 | watts |
| Screen Dissipation (Carrier) | 10 | watts |

TYPICAL OPERATION

| | | |
|------------------------|------|-------|
| D-C Plate Voltage | 1250 | volts |
| D-C Screen Voltage | 300 | volts |
| D-C Grid Voltage | -30 | volts |
| D-C Plate Current | 60 | ma |
| D-C Screen Current | 2 | ma |
| D-C Grid Current | 0.9 | ma |
| Peak R-F Input Voltage | 90 * | volts |
| R-F Driving Power | 4 * | watts |
| Carrier Power Output | 25 | watts |
| Peak Power Output | 100* | watts |

*At the peak of the a-f cycle with 100% modulation.

OPERATING NOTES

FREQUENCY RANGE

The RK-47 may be operated at the maximum ratings at frequencies up to 30 megacycles. Above 30 megacycles the reduced efficiency realized requires that the plate voltage be lowered to a maximum of 900 volts to prevent the plate dissipation from exceeding the maximum rated value. The operation of the tube at frequencies higher than 60 megacycles is not recommended.

EXCITATION

The Class C amplifier characteristic curves show the power output, plate current and screen current plotted vs. excitation as denoted by the d-c control grid current in milliampers. The power output flattens off around 7 or 8 ma. of grid current with very little gained above these values. The screen dissipation increases with excitation and for this reason the excitation should be kept at a reasonable value.

SHIELDING

Shielding of the grid input tuning system from the plate tuning apparatus is desirable and will provide improved stability. If a shield is applied to the RK-47, it should enclose the base and extend to the lower internal shield and should clear the glass bulb by at least 1/16".

BIAS

At least 25 volts of fixed bias should be used with 1250 volts on the plate to protect the tube in case of failure of the bias or excitation. Additional bias may be obtained by the use of a grid or cathode resistor.

CRYSTAL OSCILLATOR

The RK-47 is not recommended for use as a crystal controlled oscillator.

PLATE TEMPERATURE

The plate of the RK-47 will show a dull cherry red color (See Plate Temperature Color Scale) at the center of the plate, if viewed in the dark, when operated at the maximum rated plate dissipation. Dissipations above the rated value should be avoided.

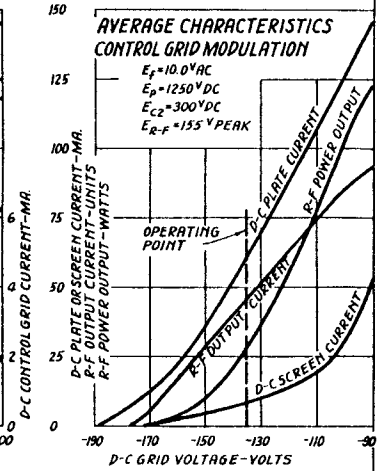
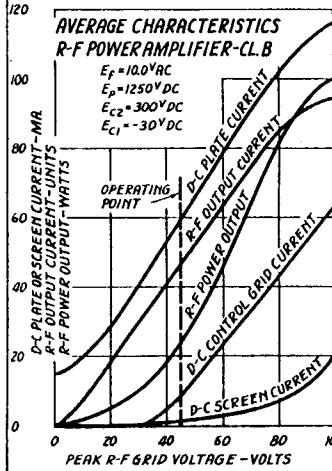
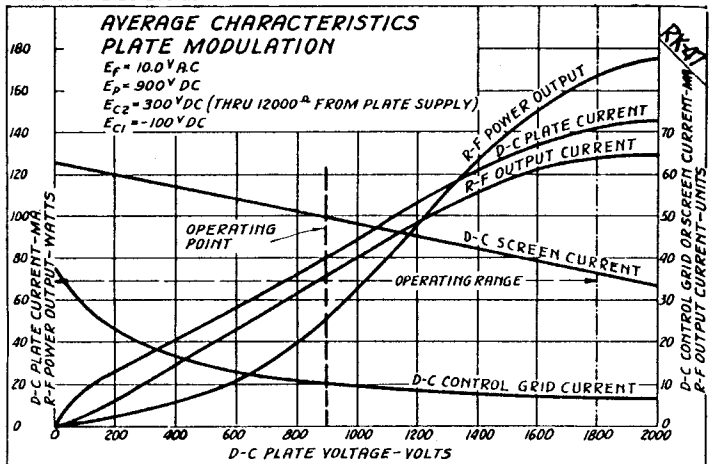

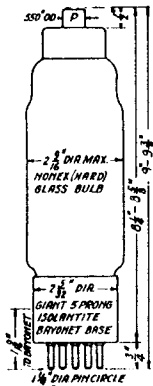

TETRODE POWER AMPLIFIER OSCILLATOR

The RK-48 is a beam type aligned grid power amplifier tube having a thoriated tungsten filament, a molybdenum plate, a hard glass bulb and an isolantite base. The use of aligned grids reduces the ratio of screen current to plate current and allows more efficient utilization of the total space current. The deflector plates in the RK-48 are connected to base pin #4 which should be connected to the filament center-tap.

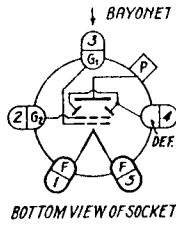

FILAMENT RATING

| | | |
|------------------|----|-------|
| Filament Voltage | 10 | volts |
| Filament Current | 5 | amp |

DIRECT INTERELECTRODE CAPACITANCES

| | | |
|---------------|------|-----|
| Grid to Plate | 0.13 | μμf |
| Input | 17 | μμf |
| Output | 13 | μμf |

R-F POWER AMP. OR OSC.—CLASS C

| MAXIMUM RATINGS | | Telephony | | Telephony | | Telephony | | Telephony | |
|---|------|-------------------|------------------|---------------------------|---------------------------|-----------|------|-----------|------|
| | | Control Grid Only | Plate Modulation | Plate & Screen Modulation | Plate & Screen Modulation | 1500 | 2000 | 1500 | 2000 |
| D-C Plate Voltage—Telegraphy | 2000 | | | | | | | | |
| D-C Plate Voltage—Telephony | 2000 | | | | | | | | |
| With Control Grid Modulation | 1500 | | | | | | | | |
| With Plate or Plate & Screen Modulation | 1500 | | | | | | | | |
| D-C Screen Voltage | 400 | | | | | | | | |
| D-C Plate Current | 180 | | | | | | | | |
| D-C Control Grid Current | 25 | | | | | | | | |
| R-F Control Grid Current | 8 | | | | | | | | |
| Plate Dissipation | 100 | | | | | | | | |
| Screen Dissipation | 22 | | | | | | | | |

TYPICAL OPERATION

| TYPICAL OPERATION | | Telephony | | Telephony | | Telephony | | Telephony | |
|------------------------|-------|-------------------|------------------|---------------------------|---------------------------|-----------|------|-----------|------|
| | | Control Grid Only | Plate Modulation | Plate & Screen Modulation | Plate & Screen Modulation | 1500 | 2000 | 1500 | 2000 |
| D-C Plate Voltage | 1500 | 2000 | 1500 | 1500 | 2000 | | | | |
| D-C Screen Voltage | 400 | 400 | 400 | 400 | 400 | | | | |
| D-C Con. Grid Voltage | -145 | -155 | -100 | -100 | -100 | | | | |
| D-C Plate Current | 77 | 74 | 148 | 156 | 180 | | | | |
| D-C Screen Current | 10 | 8 | 50 | 31 | 40 | | | | |
| D-C Con. Grid Current | 1.5 | 0.9 | 6.5 | 6.0 | 6.5 | | | | |
| Screen Resistor | — | — | 22000† | 35000‡ | — | | | | |
| Peak R-F Input Voltage | 162 | 167 | 165 | 160 | 170 | | | | |
| R-F Driving Power | 1.6 * | 1.05* | 1.0 | 0.9 | 1.0 | | | | |
| Carrier Power Output | 40 | 50 | 165 | 175 | 250 | | | | |
| Peak A-F Volt.—Plate | — | — | 1500* | 1500* | — | | | | |
| Peak A-F Volt.—Grid | 45 * | 45 * | — | 400 * | — | | | | |
| A-F Modulating Power | 0.45* | 0.28* | 115 | 140 | — | | | | |
| Peak Power Output | 160 * | 200 * | 660 * | 700 * | — | | | | |

*At the peak of the a-f cycle with 100% modulation.
 †Connected direct to plate supply voltage and by-passed for r.f. only.
 ‡Connected to plate end of modulation trans. and by-passed for r.f. only.

R-F POWER AMPLIFIER—CLASS B—TELEPHONY

MAXIMUM RATINGS

| | | |
|------------------------------|------|-------|
| D-C Plate Voltage | 2000 | volts |
| D-C Screen Voltage | 400 | volts |
| D-C Plate Current (Carrier) | 100 | ma |
| Plate Dissipation (Carrier) | 100 | watts |
| Screen Dissipation (Carrier) | 10 | watts |

TYPICAL OPERATION

| | | |
|--------------------------|-------|-------|
| D-C Plate Voltage | 2000 | volts |
| D-C Screen Voltage | 400 | volts |
| D-C Control Grid Voltage | -35 | volts |
| D-C Plate Current | 76 | ma |
| D-C Screen Current | 6 | ma |
| D-C Grid Current | 0.35 | ma |
| Peak R-F Input Voltage | 80 * | volts |
| R-F Driving Power | 0.22* | watts |
| Carrier Power Output | 60 | watts |
| Peak Power Output | 240 * | watts |

OPERATING NOTES

FREQUENCY RANGE

The RK-48 may be operated at the maximum ratings at frequencies up to 30 megacycles. Above 30 megacycles the reduced efficiency realized requires that the plate voltage be lowered to a maximum of 1500 volts to prevent the plate dissipation from exceeding the maximum rated value. The operation of the tube at frequencies higher than 60 megacycles is not recommended.

EXCITATION

The Class C amplifier characteristic curves show the power output, plate current and screen current plotted vs. excitation as denoted by the d-c control grid current in milliamperes. The power output flattens off around 6 or 7 ma of grid current with very little gained above these values. The screen dissipation increases with excitation and for this reason the excitation should be kept at a reasonable value.

SHIELDING

Shielding of the grid input tuning system from the plate tuning apparatus is desirable and will provide improved stability. If a shield is applied to the RK-48 it should enclose the base and extend to the lower internal shield and should clear the glass bulb by at least 1/16".

BIAS

At least 35 volts of fixed bias should be used with 2000 volts on the plate to protect the tube in case of failure of the bias or excitation. Additional bias may be obtained by the use of a grid or cathode resistor.

CRYSTAL OSCILLATOR

The RK-48 is not recommended for use as a crystal controlled oscillator.

PLATE TEMPERATURE

The plate of the RK-48 will show a light red color (See Plate Temperature Color Scale) when operated at the maximum rated plate dissipation. Dissipations above the rated value should be avoided.

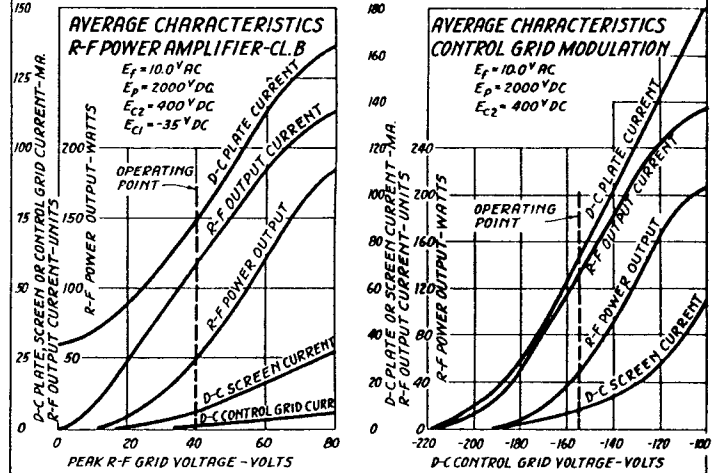
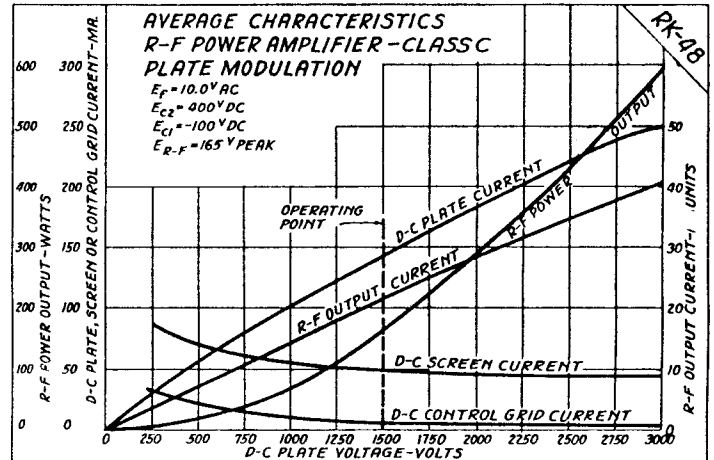
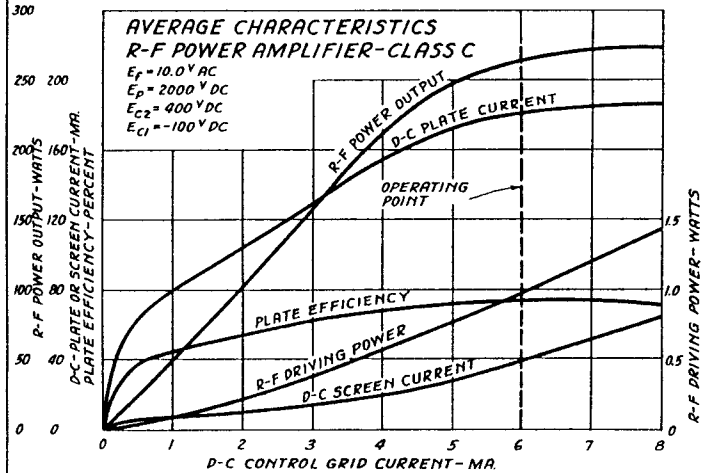
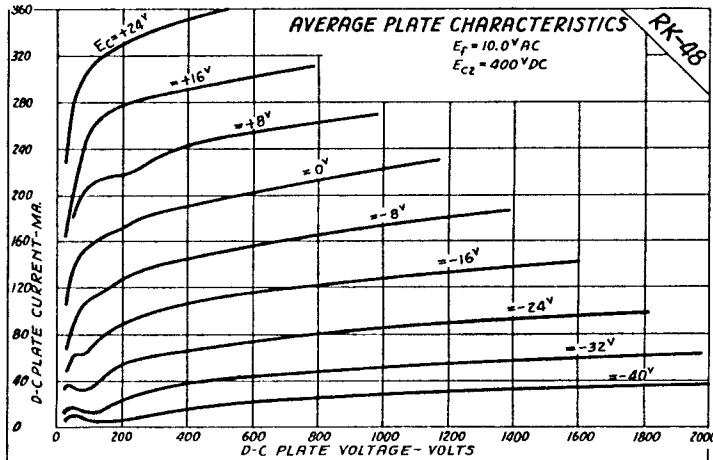

TETRODE POWER AMPLIFIER OSCILLATOR

The RK-49 is a heater type aligned grid beam power amplifier tube having an isolantite base. The use of aligned grids reduces the ratio of screen current to plate current and allows more efficient utilization of the total space current. The electrical characteristics are similar to those of the type 6L6G.

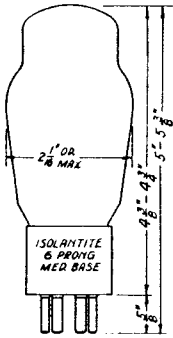
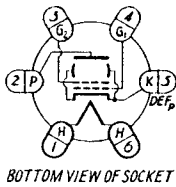

HEATER RATING

| | | |
|--------------|-----|-------|
| Heater Volt. | 6.3 | volts |
| Heater Cur. | 0.9 | amp |

DIRECT INTERELECTRODE CAPACITANCES

| | | |
|---------------|------|---------------|
| Grid to Plate | 1.4 | μf |
| Input | 11.5 | μf |
| Output | 10.6 | μf |

R-F POWER AMPLIFIER OR OSCILLATOR—CLASS C

| | 400 | volts |
|--|-----|-------|
| D-C Plate Voltage—Telephony | 400 | volts |
| D-C Plate Voltage—Telephony—With Control Grid Mod. With Plate or Plate and Screen Modulation | 300 | volts |
| D-C Screen Voltage | 300 | volts |
| D-C Plate Current | 100 | ma |
| D-C Control Grid Current | 6 | ma |
| Plate Dissipation | 21 | watts |
| Screen Dissipation | 3.5 | watts |

TYPICAL OPERATION

| | Telephony Control Grid Modulation | Telephony Plate Only Modulation | Telephony Plate & Screen Modulation | Telephony | |
|--------------------------|-----------------------------------|---------------------------------|-------------------------------------|-----------|-------|
| D-C Plate Voltage | 400 | 300 | 300 | 400 | volts |
| D-C Screen Voltage | 250 | 200 | 200 | 250 | volts |
| D-C Control Grid Voltage | -40 | -45 | -45 | -50 | volts |
| D-C Plate Current | 55 | 60 | 60 | 95 | ma |
| D-C Screen Current | 4 | 18 | 15 | 8 | ma |
| D-C Control Grid Current | 0.5 | 6 | 5 | 3 | ma |
| Screen Resistor | — | 5500 Ω | 6700 Ω | — | ohms |
| Peak R-F Input Voltage | 47 | 64 | 64 | 80 | volts |
| R-F Driving Power | 0.3 * | 0.34 | 0.3 | 0.2 | watts |
| Carrier Power Output | 7 | 12 | 13 | 25 | watts |
| Peak A-F Volt.—Plate | — | 300* | 300* | — | volts |
| Peak A-F Volt.—Grid | 25 * | — | 200* | — | volts |
| A-F Modulating Power | 0.15* | 9 | 11 | — | watts |
| Peak Power Output | 28 * | 48 * | 52 * | — | watts |

*At the peak of the a-f cycle with 100% modulation.
 †Connected direct to plate supply voltage and by-passed for r.f. only.
 ‡Connected to plate end of modulation trans. and by-passed for r.f. only.

R-F POWER AMPLIFIER—CLASS B—TELEPHONY

MAXIMUM RATINGS

| | | |
|------------------------------|-----|-------|
| D-C Plate Voltage | 400 | volts |
| D-C Screen Voltage | 300 | volts |
| D-C Plate Current (Carrier) | 75 | ma |
| Plate Dissipation (Carrier) | 21 | watts |
| Screen Dissipation (Carrier) | 3.5 | watts |

TYPICAL OPERATION

| | | |
|------------------------|------|-------|
| D-C Plate Voltage | 400 | volts |
| D-C Screen Voltage | 250 | volts |
| D-C Grid Voltage | -30 | volts |
| D-C Plate Current | 52 | ma |
| D-C Screen Current | 5 | ma |
| D-C Grid Current | 0.1 | ma |
| Peak R-F Input Voltage | 60 * | volts |
| R-F Driving Power | 0.5* | watts |
| Carrier Power Output | 7 | watts |
| Peak Power Output | 28 * | watts |

*At the peak of the a-f cycle with 100% modulation.

OPERATING NOTES

FREQUENCY RANGE

The RK-49 may be operated at the maximum ratings at frequencies up to 15 megacycles. Above 15 megacycles the reduced efficiency realized requires that the plate voltage be reduced to a maximum of 300 volts to prevent the plate dissipation from exceeding the maximum rated value. The operation of the tube at frequencies higher than 60 megacycles is not recommended.

EXCITATION

The Class C amplifier characteristic curves show the power output, plate current and screen current plotted vs. excitation as denoted by the d-c control grid current in milliamperes. The power output flattens off around 3 or 4 ma. of grid current with very little gained above these values. The screen dissipation increases with excitation and for this reason the excitation should be kept at a reasonable value.

SHIELDING

Shielding of the grid input tuning system from the plate tuning apparatus is desirable and will provide improved stability. Due to the high grid to plate capacitance, the RK-49 requires neutralization.

BIAS

At least 25 volts of fixed bias should be used with 400 volts on the plate to protect the tube in case of failure of the bias or excitation. Additional bias may be obtained by the use of a grid or cathode resistor.

CRYSTAL OSCILLATOR

When the RK-49 is used as a crystal controlled oscillator, a 10000 ohm grid leak and a 400 ohm cathode resistor are recommended to give maximum power output and easy starting.

PLATE TEMPERATURE

The plate of the RK-49 will not show color when operated at the maximum rated plate dissipations. Dissipations above the rated value should be avoided.

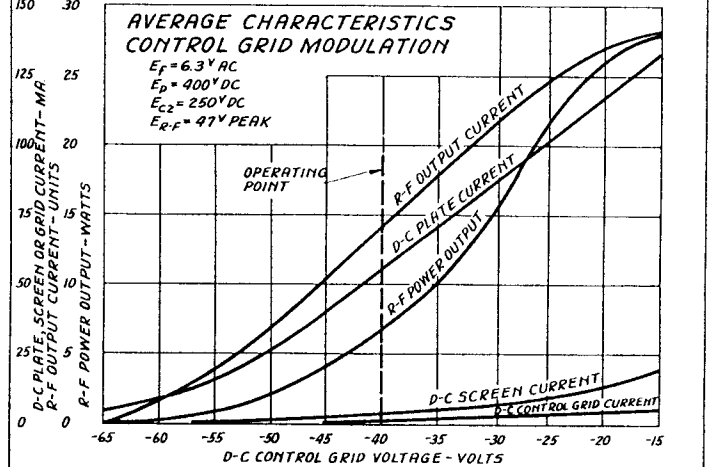
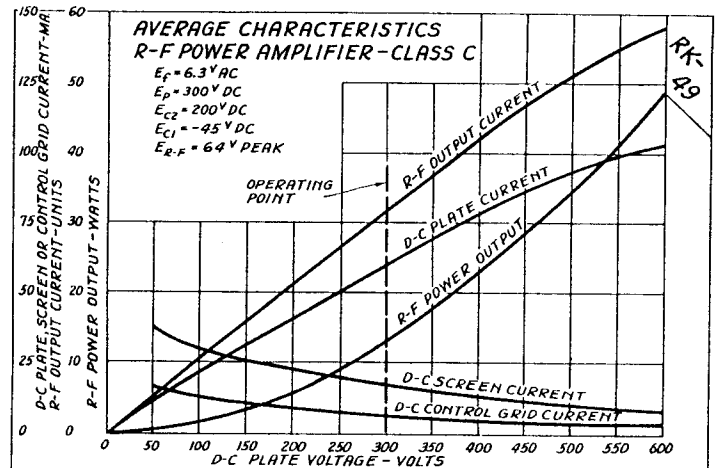
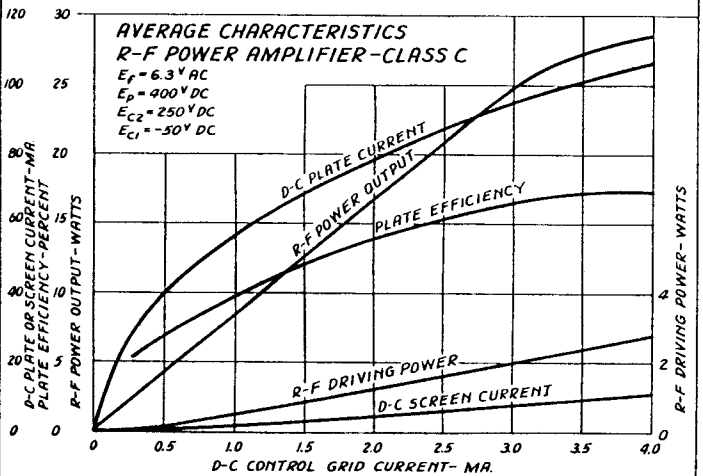
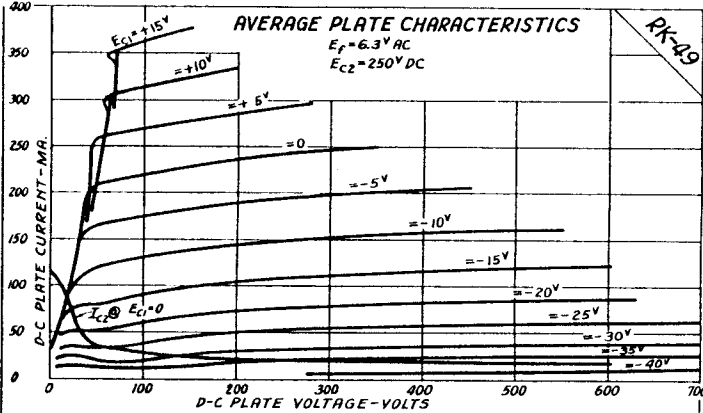

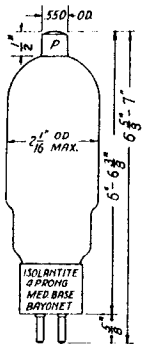

TRIODE POWER AMPLIFIER OSCILLATOR

The RK-51 is a triode type power amplifier tube having a thoriated tungsten filament, a carbon plate, a hard glass bulb, and an isolantite base. It is designed for use as a power amplifier, oscillator or frequency multiplier.

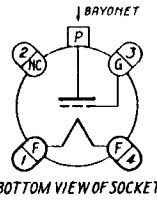

AMPLIFICATION FACTOR 20
FILAMENT RATING

| | | |
|------------------|------|-------|
| Filament Voltage | 7.5 | volts |
| Filament Current | 3.75 | amp |

DIRECT INTERELECTRODE CAPACITANCES

| | | |
|---------------|-----|------------------|
| Grid to Plate | 6 | $\mu\mu\text{f}$ |
| Input | 6 | $\mu\mu\text{f}$ |
| Output | 2.5 | $\mu\mu\text{f}$ |

R-F POWER AMPLIFIER OR OSCILLATOR—CLASS C—TELEGRAPHY

MAXIMUM RATINGS

| | | |
|-------------------|------|-------|
| D-C Plate Voltage | 1500 | volts |
| D-C Plate Current | 150 | ma |
| D-C Grid Current | 40 | ma |
| Plate Dissipation | 60 | watts |

TYPICAL OPERATION

| | | | |
|------------------------|------|------|-------|
| D-C Plate Voltage | 1250 | 1500 | volts |
| D-C Grid Voltage | -200 | -250 | volts |
| D-C Plate Current | 150 | 150 | ma |
| D-C Grid Current | 38 | 31 | ma |
| Peak R-F Input Voltage | 320 | 365 | volts |
| R-F Driving Power | 11 | 10 | watts |
| Power Output | 135 | 170 | watts |

R-F POWER AMPLIFIER—CLASS B—TELEPHONY

MAXIMUM RATINGS

| | | |
|-----------------------------|------|-------|
| D-C Plate Voltage | 1500 | volts |
| D-C Plate Current (Carrier) | 60 | ma |
| Plate Dissipation (Carrier) | 60 | watts |

TYPICAL OPERATION

| | | |
|------------------------|------|-------|
| D-C Plate Voltage | 1500 | volts |
| D-C Grid Voltage | -75 | volts |
| D-C Plate Current | 60 | ma |
| Peak R-F Input Voltage | 170* | volts |
| R-F Driving Power | 3.5* | watts |
| Carrier Power Output | 30 | watts |
| Peak Power Output | 120* | watts |

*At the peak of the a-f cycle with 100% modulation.

R-F POWER AMPLIFIER—CLASS C—TELEPHONY

MAXIMUM RATINGS

| | Grid Modulation | Plate Modulation | |
|-----------------------------|-----------------|------------------|-------|
| D-C Plate Voltage | 1500 | 1250 | volts |
| D-C Plate Current (Carrier) | 60 | 105 | ma |
| D-C Grid Current (Carrier) | 5 | 40 | ma |
| Plate Dissipation (Carrier) | 60 | 40 | watts |

TYPICAL OPERATION

| | Grid Modulation | Plate Modulation | |
|-----------------------------|-----------------|------------------|-------|
| D-C Plate Voltage | 1500 | 1000 1250 | volts |
| D-C Grid Voltage | -130 | -150 -200 | volts |
| D-C Plate Current | 60 | 115 105 | ma |
| D-C Grid Current | 0.4 | 30 17 | ma |
| Peak R-F Input Voltage | 140 | 245 290 | volts |
| R-F Driving Power | 2.3* | 6.6 4.5 | watts |
| Carrier Power Output | 32 | 83 96 | watts |
| Peak A-F Modulating Voltage | 65* | 1000*1250* | volts |
| A-F Modulating Power | 1.05* | 58 67 | watts |
| Peak Power Output | 128* | 332* 384* | watts |

*At the peak of the a-f cycle with 100% modulation.

OPERATING NOTES

FREQUENCY RANGE

The construction of the RK-51 allows operation at the maximum ratings at frequencies up to 60 megacycles. Above 60 megacycles the reduced efficiency realized requires that the plate voltage be lowered to prevent the plate dissipation from exceeding the maximum rated value.

BIAS

A fixed bias voltage of at least 60 volts should be used with a plate voltage of 1500 volts to protect the tube in case of failure of the bias or excitation. The fixed bias may be reduced with lower plate voltage.

PLATE TEMPERATURE

The plate of the RK-51 will not show color when operated at the maximum rated plate dissipation. Dissipations above the rated value should be avoided.

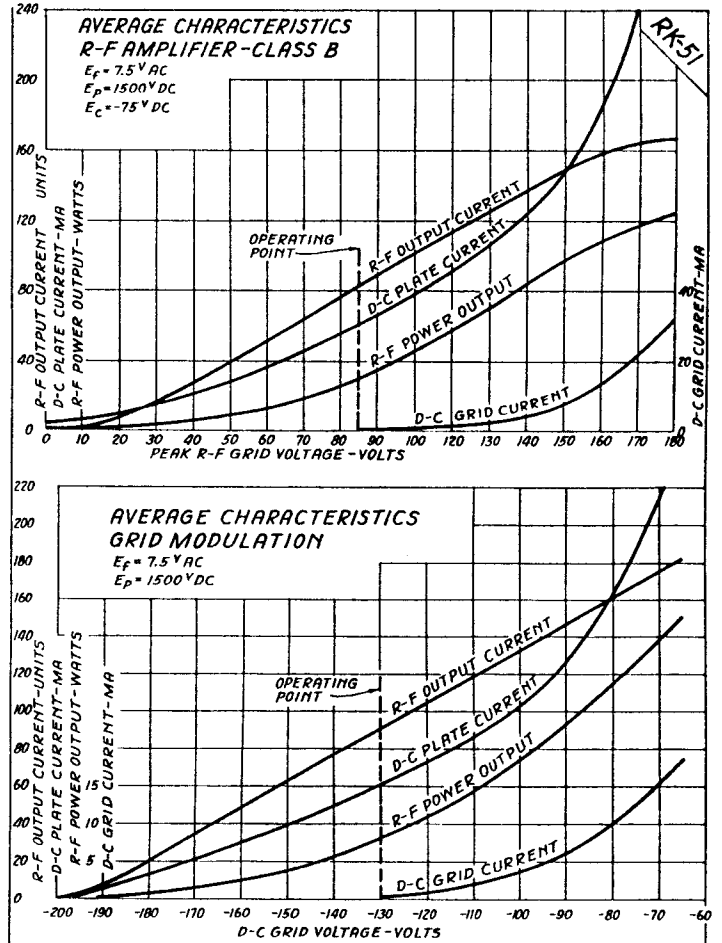
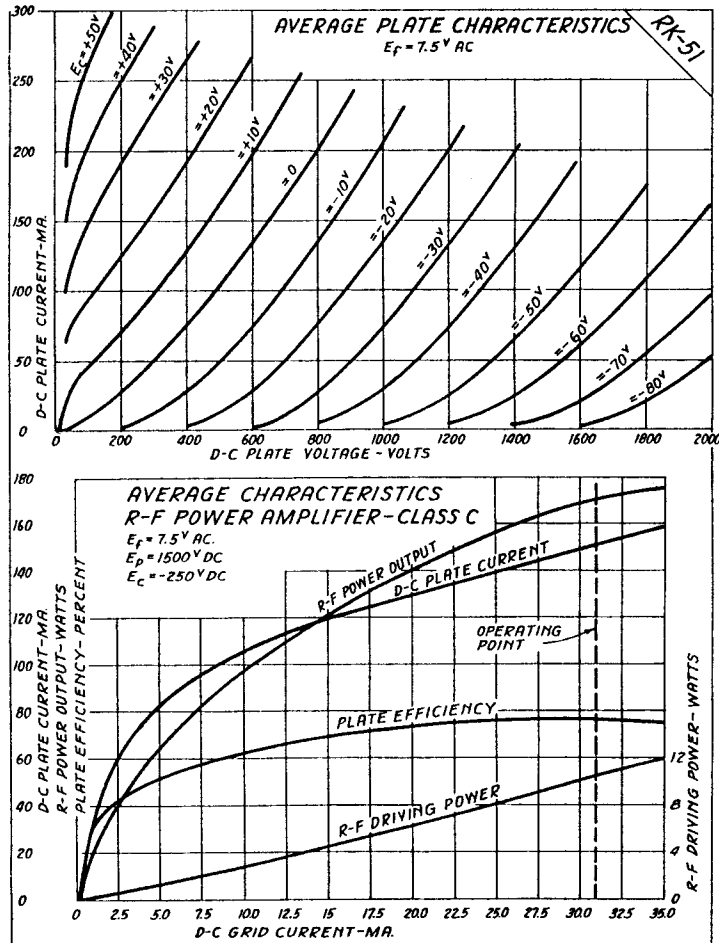

**TRIODE
POWER AMPLIFIER
OSCILLATOR**

The RK-52 is a high- μ triode type power amplifier tube having a thoriated tungsten filament, a carbon plate, a hard glass bulb and an isolantite base. It is designed for use as a power amplifier, oscillator or frequency multiplier.

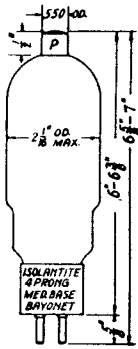
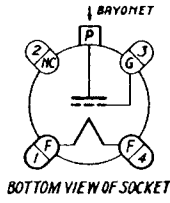

FILAMENT RATING

| | | |
|------------------|------|-------|
| Filament Voltage | 7.5 | volts |
| Filament Current | 3.75 | amp |

DIRECT INTERELECTRODE CAPACITANCES

| | | |
|---------------|-----|------------------|
| Grid to Plate | 12 | $\mu\mu\text{f}$ |
| Input | 6.6 | $\mu\mu\text{f}$ |
| Output | 2.2 | $\mu\mu\text{f}$ |

A-F POWER AMPLIFIER—CLASS B—TWO TUBES

MAXIMUM RATINGS

| | | |
|------------------------------|------|-------|
| D-C Plate Voltage | 1250 | volts |
| D-C Plate Current (per tube) | 150 | ma |
| Plate Dissipation (per tube) | 62.5 | watts |

(Average over 1 cycle)

TYPICAL OPERATION

| | | |
|--------------------------------------|-------|-------|
| D-C Plate Voltage | 1250 | volts |
| D-C Grid Voltage | 0 | volts |
| D-C Plate Current (no signal) | 40 | ma |
| D-C Plate Current (max. signal) | 300 | ma |
| D-C Grid Current (max. signal) | 100 | ma |
| Peak A-F Grid Voltage (grid to grid) | 180 | volts |
| A-F Driving Power | 7.5 | watts |
| Load Resistance (plate to plate) | 10000 | ohms |
| Power Output | 250 | watts |

R-F POWER AMPLIFIER—CLASS C—TELEGRAPHY

MAXIMUM RATINGS

| | | |
|-------------------|------|-------|
| D-C Plate Voltage | 1500 | volts |
| D-C Plate Current | 130 | ma |
| D-C Grid Current | 50 | ma |
| Plate Dissipation | 60 | watts |

TYPICAL OPERATION

| | | | |
|------------------------|------|------|-------|
| D-C Plate Voltage | 1250 | 1500 | volts |
| D-C Grid Voltage | -120 | -120 | volts |
| D-C Plate Current | 150 | 130 | ma |
| D-C Grid Current | 41 | 40 | ma |
| Peak R-F Input Voltage | 200 | 195 | volts |
| R-F Driving Power | 7.4 | 7 | watts |
| Power Output | 130 | 135 | watts |

R-F POWER AMPLIFIER—CLASS C—TELEPHONY—

PLATE MODULATION

MAXIMUM RATINGS

| | | |
|-------------------|------|-------|
| D-C Plate Voltage | 1250 | volts |
| D-C Plate Current | 115 | ma |
| D-C Grid Current | 50 | ma |
| Plate Dissipation | 40 | watts |

TYPICAL OPERATION

| | | | |
|------------------------|------|------|-------|
| D-C Plate Voltage | 1000 | 1250 | volts |
| D-C Grid Voltage | -120 | -120 | volts |
| D-C Plate Current | 125 | 115 | ma |
| D-C Grid Current | 41 | 47 | ma |
| Peak R-F Input Voltage | 195 | 200 | volts |
| R-F Driving Power | 7.2 | 8.5 | watts |
| A-F Modulating Power | 63 | 72 | watts |
| Carrier Power Output | 90 | 105 | watts |
| Peak Power Output | 360 | 420 | watts |

OPERATING NOTES

FREQUENCY RANGE

The construction of the RK-52 allows operation at the maximum ratings at frequencies up to 60 megacycles. Above 60 megacycles the reduced efficiency realized requires that the plate voltage be lowered to prevent the plate dissipation from exceeding the maximum rated value.

PLATE TEMPERATURE

The plate of the RK-52 will not show color when operated at the rated plate dissipation. Dissipations above the rated value should be avoided.

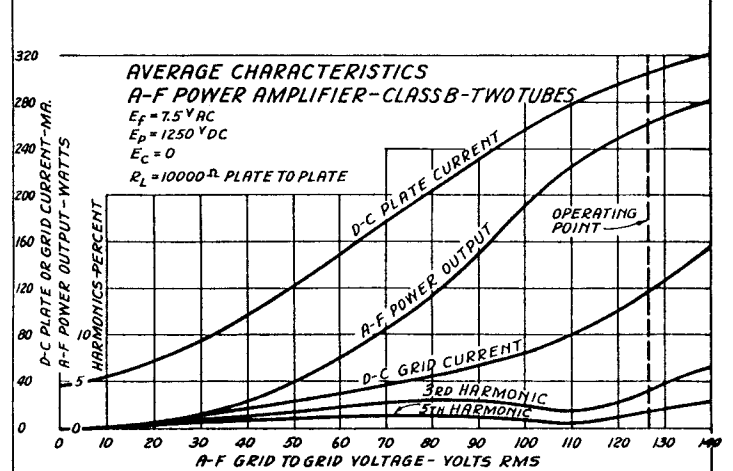
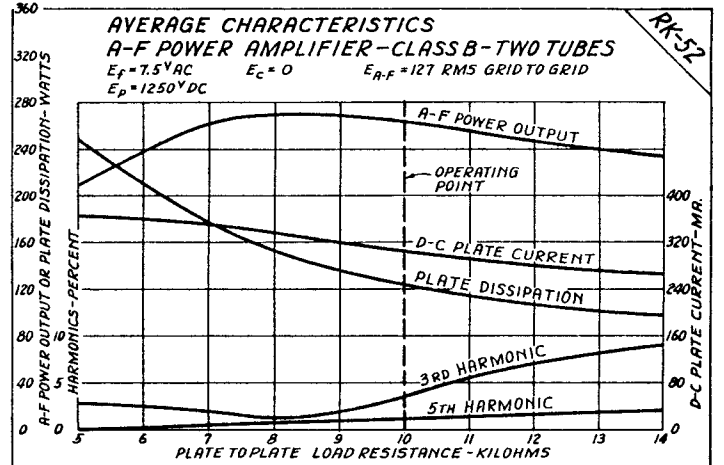
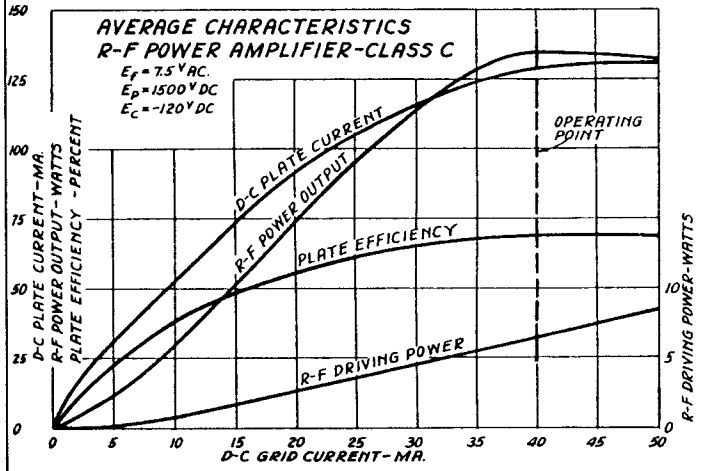
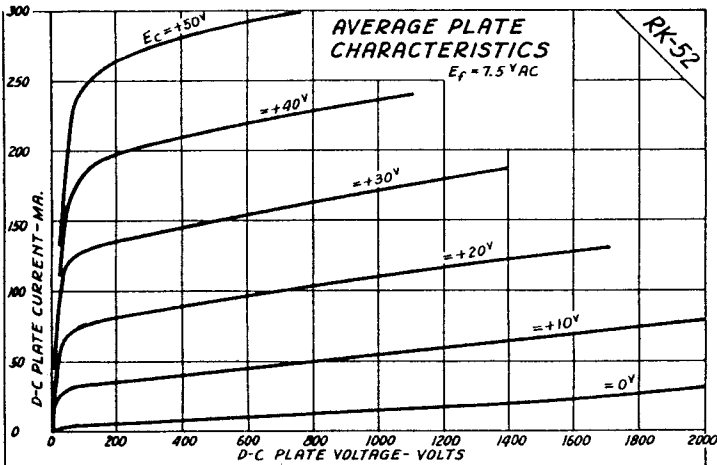

GASEOUS DISCHARGE TRIODE POWER AMPLIFIER OSCILLATOR

The RK-100 is a heater type gaseous discharge tube designed for use as a power amplifier or oscillator. The RK-100 differs from conventional tubes in that it contains mercury vapor and an auxiliary grid, number one grid, which acts as an anode for the ionizing discharge and as a virtual cathode for the amplifier section of the tube. In practice the actual cathode is used as the zero potential point for the circuit returns.

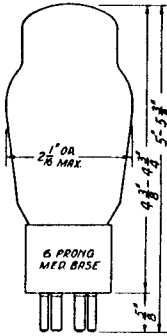
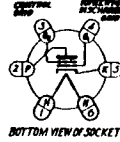

HEATER RATING

Table with 2 columns: Heater Voltage (6.3 volts), Heater Current (0.9 amp).

DIRECT INTERELECTRODE CAPACITANCES

Table with 2 columns: Grid to Plate (19 pF), Input (23 pF), Output (3 pF).

A-F POWER AMPLIFIER—CLASS A MAXIMUM RATINGS

Table with 2 columns: D-C Plate Voltage (150 volts), D-C Plate Current (250 ma), D-C Control Grid Current (100 ma), D-C Ionizing Current (250 ma), Plate Dissipation (15 watts).

TYPICAL OPERATION—SINGLE TUBE

Table with 2 columns: D-C Plate Voltage (110 volts), D-C Control Grid Voltage (-1.6 volts), D-C Ionizing Current (150 ma), D-C Plate Current (50 ma), D-C Control Grid Current (7 ma), A-F Grid Voltage (6 volts), Amplification Factor (40), Plate Resistance (3600 ohms), Transconductance (12000 umhos), Load Resistance (1600 ohms), Power Output (3.2 watts).

TYPICAL OPERATION—PUSH-PULL—TWO TUBES

Table with 2 columns: D-C Plate Voltage (110 volts), D-C Control Grid Voltage (-1.6 volts), D-C Ionizing Current (150 ma), D-C Plate Current (100 ma), D-C Control Grid Current (14 ma), A-F Grid Voltage (13 volts), Load Resistance (2000 ohms), Power Output (7 watts).

R-F POWER AMPLIFIER OR OSCILLATOR—CLASS C MAXIMUM RATINGS

Table with 2 columns: D-C Plate Voltage (150 volts), D-C Plate Current (250 ma), D-C Control Grid Current (100 ma), D-C Ionizing Current (250 ma), Plate Dissipation (15 watts).

TYPICAL OPERATION—R-F OSCILLATOR—CLASS C

Table with 2 columns: D-C Plate Voltage (110 volts), D-C Ionizing Current (150 ma), D-C Plate Current (80 ma), D-C Control Grid Current (8 ma), Control Grid Resistor (500 ohms), Power Output (3.5 watts).

TYPICAL OPERATION—R-F AMPLIFIER—CLASS C

Table with 2 columns: D-C Plate Voltage (110 volts), D-C Ionizing Current (150 ma), D-C Plate Current (175 ma), D-C Control Grid Current (39 ma), Control Grid Resistor (500 ohms), Peak R-F Input Voltage (35 volts), Driving Power (2 watts), Power Output (11 watts).

OPERATING NOTES

IONIZING DISCHARGE CIRCUIT

Under all conditions a separate current limiting resistor should be used in series with the number one grid of each tube in order to limit the discharge current to or under the rated value, as the voltage drop from the number one grid to the cathode is approximately 10 volts.

CIRCUIT OPERATION

The operation of the RK-100 is similar to that of a conventional high vacuum tube except for the ionizing discharge mentioned above and the markedly different values of tube parameters such as high transconductance and high grid current.

The internal impedance of the RK-100 is very low with a large signal on the grid. This makes it necessary to tap down on the output plate coil to match the low tube impedance. The input impedance is low so relatively few turns are required on the secondary of the driver transformer for optimum conditions. The above characteristics, low input and output impedances, make it difficult to obtain the same power from a self-excited oscillator as can be obtained from a driven amplifier. The power necessary to drive the tube may be obtained from conventional tubes such as the type 48 or one RK-100 will drive two RK-100 tubes.

IMPORTANT

When first placing the RK-100 in operation it should be allowed to warm up for about 15 minutes to insure that no drops of mercury are shorting the elements. Thereafter, this precaution need not be taken unless the tube has been handled in such a way as to get mercury on the elements.

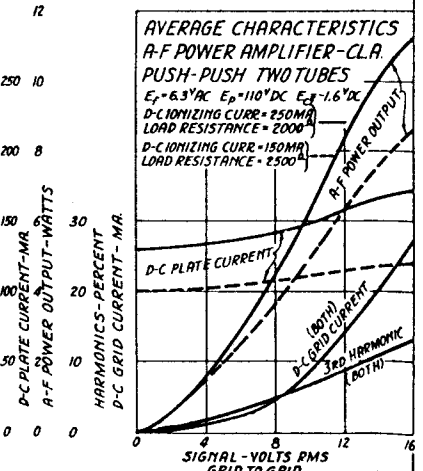
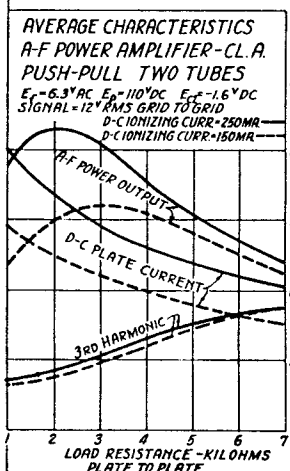
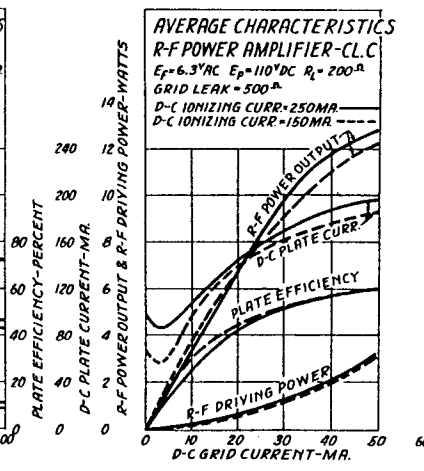
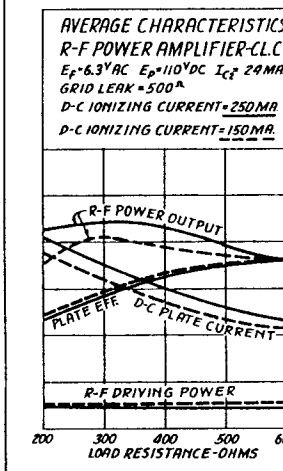
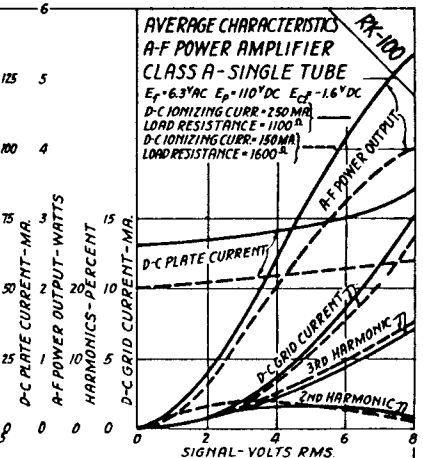
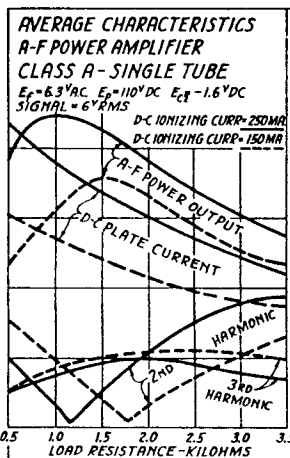
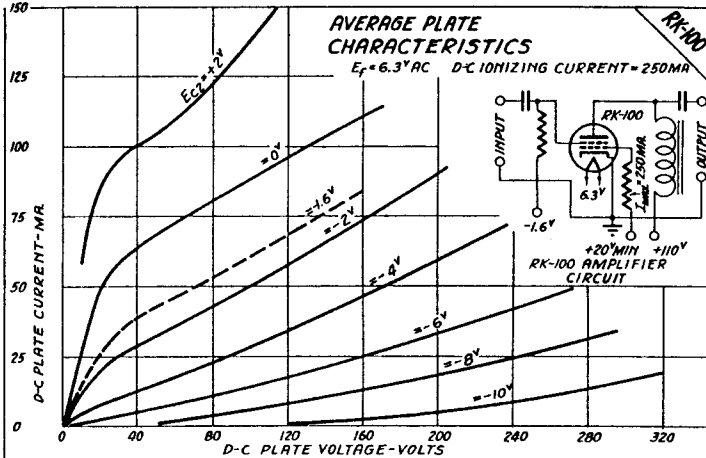

841 TRIODE POWER AMPLIFIER OSCILLATOR

The 841 is a high- μ triode type power amplifier tube having a thoriated tungsten filament and an isolantite base. It is designed for use as a power amplifier or oscillator.

FILAMENT RATING

| | | |
|----------------|------|-------|
| Filament Volt. | 7.5 | volts |
| Filament Cur. | 1.25 | amp |

DIR. INTERELEC. CAPAC.

| | | |
|---------------|---|---------------|
| Grid to Plate | 7 | μf |
| Input | 4 | μf |
| Output | 3 | μf |

A-F AMPLIFIER—CL. A—RES. COUPLED

| | | |
|--------------------------|------|-------|
| MAXIMUM RATINGS | | |
| D-C Plate Voltage | 425 | volts |
| D-C Plate Supply Voltage | 1250 | volts |
| Plate Dissipation | 12 | watts |

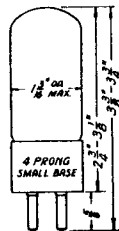
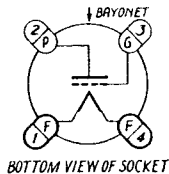
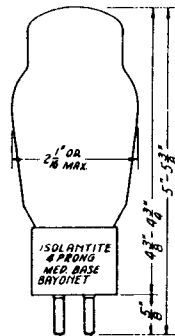

864 TRIODE AMPLIFIER DETECTOR

The 864 is a filament type triode amplifier tube designed for use as a detector or audio frequency amplifier in applications requiring a non-microphonic tube.

FILAMENT RATING

| | | |
|----------------|------|-------|
| Filament Volt. | 1.1 | volts |
| Filament Cur. | 0.25 | amp |

DIRECT INTERELECTRODE CAPACITANCES

| | | |
|---------------|-----|---------------|
| Grid to Plate | 5.3 | μf |
| Input | 2.3 | μf |
| Output | 2.1 | μf |

A-F AMPLIFIER—CLASS A

| | | |
|-----------------------|-----|-------|
| MAXIMUM RATING | | |
| D-C Plate Voltage | 135 | volts |

TYPICAL OPERATION

| | | | |
|----------------------|-------|-------|------------------|
| D-C Plate Voltage | 90 | 135 | volts |
| D-C Grid Voltage | -4.5 | -9.0 | volts |
| D-C Plate Current | 2.9 | 3.5 | ma |
| Amplification Factor | 8.2 | 8.2 | |
| Transconductance | 610 | 645 | μmhos |
| Plate Resistance | 13500 | 12700 | ohms |

Grid Coupling Resistor, if used, must not exceed 2.0 megohms.

DETECTOR—BIASED TYPE

| | | |
|-----------------------|-----|-------|
| MAXIMUM RATING | | |
| D-C Plate Voltage | 135 | volts |

TYPICAL OPERATION

| | | | |
|-------------------|-----------------------------------|-----|-------|
| D-C Plate Voltage | 90 | 135 | volts |
| D-C Grid Voltage | -10.5 | -15 | volts |
| D-C Plate Current | Adjusted to 0.2 ma with no signal | | |

DETECTOR—GRID LEAK TYPE

| | | |
|-----------------------|----|-------|
| MAXIMUM RATING | | |
| D-C Plate Voltage | 45 | volts |

TYPICAL OPERATION

| | | |
|-------------------|--------|---------------|
| D-C Plate Voltage | 45 | volts |
| Grid Leak | 0.25-5 | megohms |
| Grid Condenser | 0.0025 | μf |

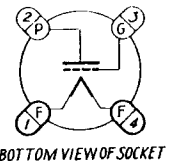

TYPICAL OPERATION

| | | | |
|-------------------------------------|-------|-------|------------------|
| D-C Plate Supply Voltage | 425 | 1000 | volts |
| D-C Grid Voltage | -6 | -9 | volts |
| D-C Plate Current | 0.7 | 2.2 | ma |
| Amplification Factor | 30 | 30 | |
| Plate Resistance | 63000 | 40000 | ohms |
| Transconductance | 450 | 750 | μmhos |
| Peak A-F Grid Voltage | 6 | 9 | volts |
| Load Resistance | 0.25 | 0.25 | megohm |
| Voltage Output (5% second harmonic) | 126 | 225 | volts |

A-F POWER AMPLIFIER—CLASS B—TWO TUBES

| | | |
|--|-----|-------|
| MAXIMUM RATINGS | | |
| D-C Plate Voltage | 425 | volts |
| D-C Plate Current (with signal—per tube) | 60 | ma |
| Plate Dissipation (per tube) | 15 | watts |

TYPICAL OPERATION

| | | | |
|---|------|------|-------|
| D-C Plate Voltage | 350 | 425 | volts |
| D-C Grid Voltage | -5 | -5 | volts |
| D-C Plate Current (no signal) | 7 | 13 | ma |
| D-C Plate Current (max. signal) | 114 | 120 | ma |
| Peak A-F Grid Voltage (grid to grid) | 176 | 180 | volts |
| Load Resistance (plate to plate) | 5200 | 7000 | ohms |
| Power Output (max. signal) (approximate) | 21 | 28 | watts |
| Driving Power (max. signal) (approximate) | 3.2 | 3.6 | watts |

R-F POWER AMPLIFIER OR OSCILLATOR—CLASS C

| | | |
|--|-----|-------|
| MAXIMUM RATINGS | | |
| D-C Plate Voltage—Telegraphy | 450 | volts |
| D-C Plate Voltage—Telephony—Plate Modulation | 350 | volts |
| D-C Plate Current | 60 | ma |
| D-C Grid Current | 20 | ma |
| R-F Grid Current | 4 | amp |
| Plate Dissipation—Telegraphy | 15 | watts |
| Plate Dissipation—Telephony—Plate Modulation | 10 | watts |

TYPICAL OPERATION

| | | | | | |
|-----------------------|------------------|-----|-----------|-----|-------|
| | Telephony | | Telephony | | |
| | Plate Modulation | | | | |
| D-C Plate Voltage | 250 | 350 | 350 | 450 | volts |
| D-C Grid Voltage | -40 | -47 | -30 | -34 | volts |
| D-C Plate Current | 50 | 50 | 50 | 50 | ma |
| D-C Grid Current | 15 | 15 | 15 | 15 | ma |
| Peak R-F Grid Voltage | 125 | 130 | 115 | 120 | volts |
| R-F Driving Power | 2 | 2 | 1.8 | 1.8 | watts |
| Carrier Power Output | 7 | 11 | 11 | 15 | watts |
| A-F Modulating Power | 6.3 | 8.8 | — | — | watts |
| Peak Power Output | 28 | 44 | — | — | watts |

±Voltage effective at the plate is less than the plate supply voltage by the drop in the load resistor.

842 TRIODE POWER AMPLIFIER

The 842 is a low- μ triode type power amplifier tube having a thoriated tungsten filament and an isolantite base. It is designed for use as an audio frequency power amplifier.

FILAMENT RATING

| | | |
|------------------|------|-------|
| Filament Voltage | 7.5 | volts |
| Filament Current | 1.25 | amp |

DIRECT INTERELECTRODE CAPACITANCES

| | | |
|---------------|---|---------------|
| Grid to Plate | 7 | μf |
| Input | 4 | μf |
| Output | 3 | μf |

A-F POWER AMPLIFIER—CLASS A

| | | |
|------------------------|-----|-------|
| MAXIMUM RATINGS | | |
| D-C Plate Voltage | 425 | volts |
| Plate Dissipation | 12 | watts |

TYPICAL OPERATION

| | | | |
|-----------------------------------|------|------|------------------|
| D-C Plate Voltage | 350 | 425 | volts |
| D-C Grid Voltage | -72 | -100 | volts |
| D-C Plate Current | 34 | 28 | ma |
| Peak A-F Grid Voltage | 67 | 95 | volts |
| Amplification Factor | 3 | 3 | |
| Transconductance | 1250 | 1200 | μmhos |
| Plate Resistance | 2400 | 2500 | ohms |
| Load Resistance | 5000 | 8000 | ohms |
| Power Output (5% second harmonic) | 2.1 | 3.0 | watts |

For tube outline and basing view see type 841.

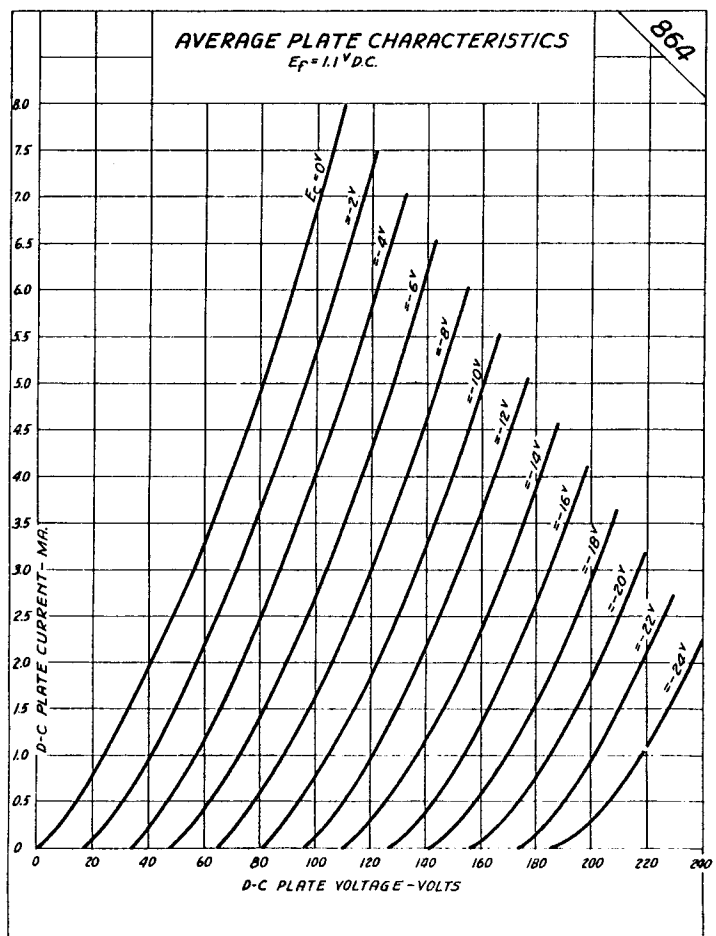

MERCURY VAPOR TYPE HALF-WAVE RECTIFIER

The 866A is a half-wave, shielded filament type mercury vapor rectifier tube particularly suited for high voltage d-c power supplies. Two type 866A tubes in a full wave rectifier circuit with a choke input filter will supply a maximum of 3000 volts d.c. at a drain of 500 milliamperes.

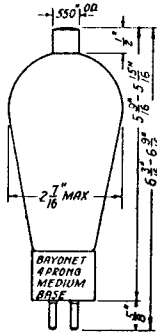

FILAMENT RATING

Filament Volt. 2.5 volts
Filament Cur. 5.0 amp

MAXIMUM RATINGS—TEMP. RANGE 25°—60° C.

Peak Inverse Voltage 10000 volts
Peak Plate Current 1.0 amp
Average Plate Current 0.25 amp
Tube Voltage Drop 10 approx. volts

TYPICAL OPERATION

| Circuit | A-C Input Voltage RMS Volts | Maximum D-C Output Volts To Filter | One Section Filter Minimum Choke Henries (L) | Maximum Condenser Mfds. (C) | Maximum D-C Output Current Amperes |
|------------------------|-----------------------------|------------------------------------|--|-----------------------------|------------------------------------|
| Single-phase Full-Wave | 3535 per tube | 3180 | 8.0 | 1.25 | 0.5 |
| Two Tubes | 2000 " " | 2700 | 6.8 | 1.50 | 0.5 |
| Choke Input | 1500 " " | 1800 | 4.5 | 2.1 | 0.5 |
| Single-phase Full-Wave | 3535 " " | 3950 | — | — | 0.25 |
| Two Tubes | 2000 " " | 3390 | — | — | 0.25 |
| Condenser Input | 1500 " " | 2260 | — | — | 0.25 |
| Single-phase Full-Wave | 7070 total | 6360 | 16.0 | 0.6 | 0.5 |
| Bridge Circuit | 6000 " " | 5400 | 13.5 | 0.7 | 0.5 |
| Four Tubes | 5000 " " | 4500 | 11.0 | 0.9 | 0.5 |
| Choke Input | 4000 " " | 3600 | 8.9 | 1.1 | 0.5 |

OPERATING NOTES

Values of L and C given under "Typical Operation" are selected to hold the peak surge current within the maximum rating. If a larger value of L is used the capacity may be increased in proportion to the increase in L. L and C of a two section filter are determined as shown above. If two unequal chokes are used, place the larger choke nearer the tube. With a two section filter and the minimum L and the maximum C shown above, the total ripple will be less than 5%.

CAUTION

In shipment drops of mercury may be shaken onto the filament. Before the plate voltage is applied to a new tube the filament should be burned at normal voltage for at least 15 minutes. The filament should be allowed to come up to operating temperature before plate voltage is applied. For average conditions the delay is approximately 30 seconds.

The tube should always be mounted vertically with the top cap up. A socket with heavy, tight prongs should be used and the filament voltage should measure exactly 2.5 volts at the socket in order to insure long life.

866

MERCURY VAPOR TYPE HALF-WAVE RECTIFIER

The 866 is a half-wave filament type mercury vapor rectifier tube particularly suited for medium drain d-c power supplies and linear amplifier bias packs. Two types 866 tubes in a full-wave rectifier circuit with a choke input filter will supply a maximum of 2000 d.c. at a drain of 500 ma.

FILAMENT RATING

Filament Voltage 2.5 volts
Filament Current 5.0 amp

MAXIMUM RATINGS—TEMP. RANGE 10°—60° C.

Peak Inverse Voltage 7500 volts
Peak Plate Current 1.0 amp
Average Plate Current 0.25 amp
Tube Voltage Drop (approximate) 15 volts

TYPICAL OPERATION

| Circuit | A-C Input Voltage RMS Volts | Maximum D-C Output Volts To Filter | One Section Filter Minimum Choke Henries (L) | Maximum Condenser Mfds. (C) | Maximum D-C Output Current Amperes |
|------------------------|-----------------------------|------------------------------------|--|-----------------------------|------------------------------------|
| Single-phase Full-Wave | 2650 per Tube | 2385 | 2.0 | 1.6 | 0.5 |
| Two Tubes | 2000 " " | 1800 | 4.9 | 1.8 | 0.5 |
| Choke Input | 1500 " " | 1350 | 3.3 | 2.8 | 0.5 |
| Single-phase Full-Wave | 2650 " " | 3000 | — | — | 0.25 |
| Two Tubes | 2000 " " | 2260 | — | — | 0.25 |
| Condenser Input | 1500 " " | 1700 | — | — | 0.25 |
| Single-phase Full-Wave | 5000 total | 4770 | 12.0 | 0.8 | 0.5 |
| Bridge Circuit | 4500 " " | 4050 | 10.0 | 1.0 | 0.5 |
| Four Tubes | 4000 " " | 3600 | 8.4 | 1.2 | 0.5 |
| Choke Input | 3500 " " | 2700 | 6.8 | 1.5 | 0.5 |

For tube outline, basing view and operating notes see type 866A.

MERCURY VAPOR TYPE HALF-WAVE RECTIFIER

The 872A is a half-wave, shielded filament type mercury vapor rectifier tube designed for heavy current, high voltage power supplies. Two type 872A tubes in a full-wave rectifier circuit with a choke input filter will supply a maximum of 2.5 amperes at 5000 volts d.c.

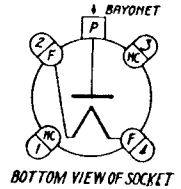

FILAMENT RATING

Filament Volt. 5.0 volts
Filament Cur. 6.75 amp

MAXIMUM RATINGS—TEMP. RANGE 20°—60° C.

Peak Inverse Voltage 1000 volts
Peak Plate Current 5.0 amp
Average Plate Current 1.25 amp
Tube Voltage Drop (approx.) .. 10 volts

TYPICAL OPERATION

| Circuit | Maximum A-C Input Volts (RMS) | Approx. D-C Output Volts To Filter | Maximum D-C Output Current—Amp. |
|--|-------------------------------|------------------------------------|---------------------------------|
| Single-phase Full-Wave Two Tubes | 3535 per tube | 3180 | 2.5 |
| Single-phase Full-Wave Bridge Circuit Four Tubes | 7070 total | 6360 | 2.5 |

The values given above are for a sine wave input voltage and with a suitable choke before the first filter condenser.

CAUTION

In shipment drops of mercury may be shaken onto the filament. Before the plate voltage is applied to a new tube the filament should be burned at normal voltage for at least 15 minutes.

In normal operation the filament should be brought up to operating temperature at least 30 seconds before the plate voltage is applied.

The tube should always be mounted vertically with the top cap up. A socket with tight, heavy prongs should be used and the filament voltage should measure exactly 5.0 volts at the socket to insure long life.

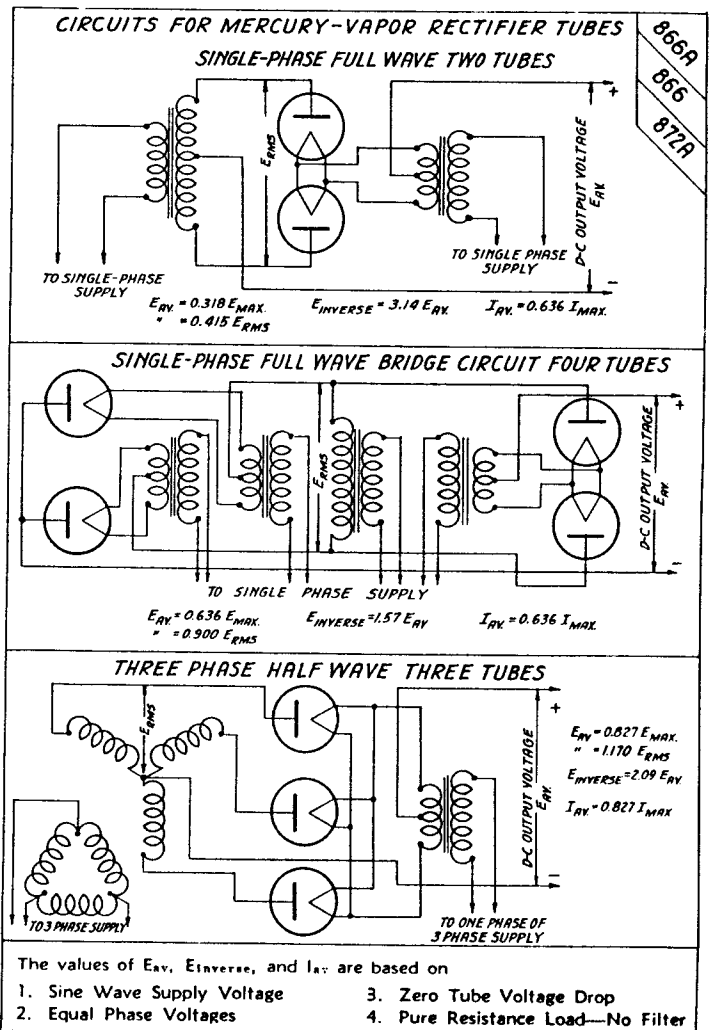

CONVERSION CURVES

The following curves, Fig. N1, N2 and N3, may be used to find the approximate operating conditions for Class A power amplifier triodes, tetrodes or pentodes at other than the published operating conditions.

Fig. N1 should be used for triodes operated at other than the published plate voltage and for tetrodes or pentodes operated at other than the published plate and screen voltages. For example, suppose it is desired to operate a Class A pentode power amplifier at a plate and screen voltage 20% lower than the published values. The percent change from the published operating conditions may be read at the intersections of the curves with the -20% ordinate. Thus, for a 20% decrease in plate and screen voltages, the grid bias should be decreased 20%, or the bias resistor increased 12%, the load resistance should be increased 12%, the plate and screen currents will be decreased 27% and the power output will decrease 48%. Values for triodes may be obtained from the curves in the same manner.

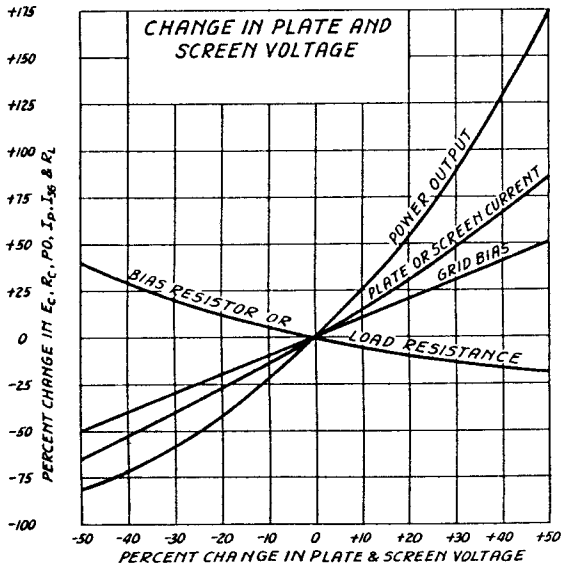

FIG. N1

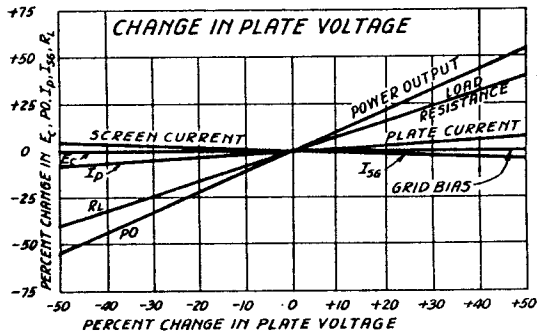

FIG. N2

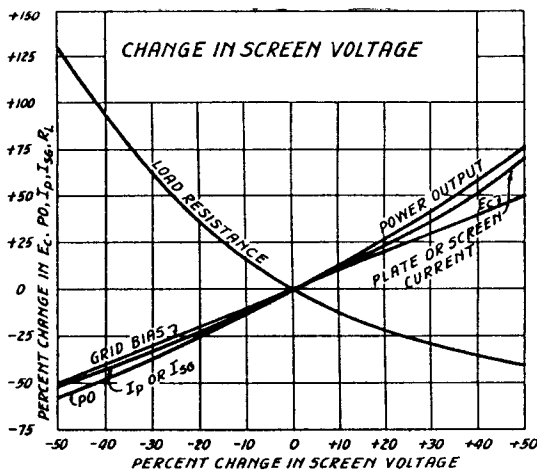

FIG. N3

Fig. N2 should be used for tetrodes and pentodes where only the plate voltage is changed and the values are read from the curves in the same way as in Fig. N1.

Fig. N3 should be used for tetrodes and pentodes where only the screen voltage is changed and the values are read from the curves as in the previous figures. Tetrodes and pentodes should not be operated with the screen voltage appreciably higher than the plate voltage.

When choosing new operating conditions for any tube, the published maximum ratings should not be exceeded.

RESISTANCE-COUPLED AMPLIFIER DESIGN CURVES

The curves in Figs. P1 to P7 give circuit design data for use with the heater type tubes commonly used in resistance-coupled amplifiers. The curves show the proper value of cathode resistor, R_c , for use with several values of plate resistor, R_L , at plate supply voltages from 90 to 300 volts. The values of output voltage, E_o , (peak volts) at maximum signal and the voltage gain, V_G are also shown by the curves.

The value of the coupling condenser, C , depends on the value of R_g , the grid resistor for the following tube and for approximately 75 percent of the high frequency response at 60 cycles, the value will be:

$$C = \text{microfarads} \quad C = \frac{0.003}{R_g} \quad (P1)$$

$R_g = \text{megohms}$

The curves were plotted using a value of $R_g = 2R_L$ in all cases.

For the condition, $R_g = R_L$, the value of R_c from the curves should be decreased 15%.

For the condition, $R_g = 4R_L$, the value of R_c from the curves should be increased 10%.

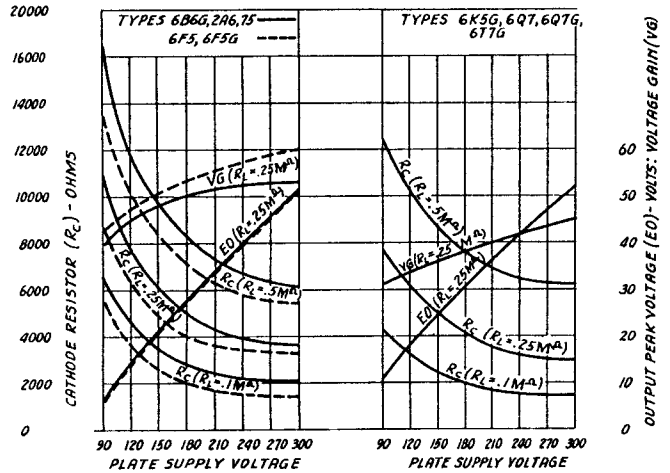

FIG. P1

FIG. P2

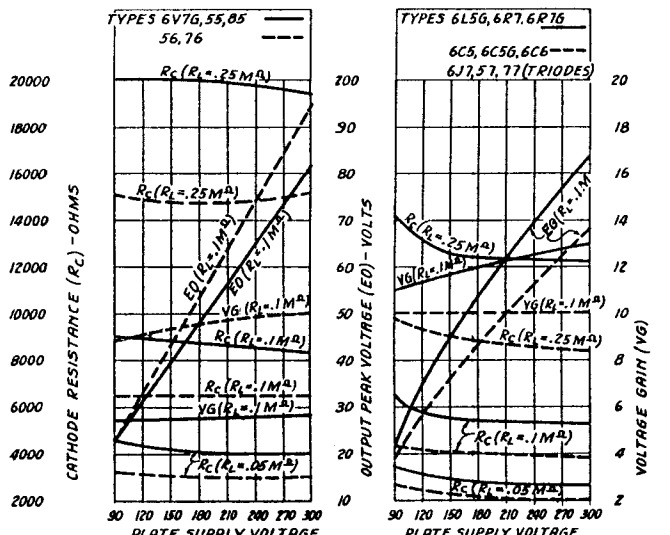

FIG. P3

FIG. P4

The value of R_z should not exceed the maximum value allowable in the grid circuit of the following tube.

The proper value of cathode by-pass condenser, C_c , may be found from the relation:

$$C_c = \text{microfarads} \quad C = \frac{7000}{R_c} \quad (P11)$$

$R_c = \text{ohms}$

The value of the series screen resistor, R_{ss} , for use with pentodes may be found from the curves and the screen by-pass condenser should be at least 0.05 to 0.1 microfarads.

The curves in Fig. P8, P9 and P10 apply to two-volt tubes and are similar to those in the previous figures except that values of grid bias instead of cathode resistor are shown.

RAYTHEON RECEIVING TUBES

Raytheon manufactures a complete line of radio receiving tubes which are listed below. Complete data on these types can be found in the Raytheon Databook on receiving tubes which also includes data on Raytheon Resistor Tubes for both ac-dc and battery operated receivers and data on Raytheon Panel Lamps.

This receiving tube Databook contains general technical information on receiving tube characteristics and operation in addition to the ratings and characteristic curves of individual tube types. It may be obtained from your dealer or directly from the Raytheon Production Corp. at a price of twenty-five cents.

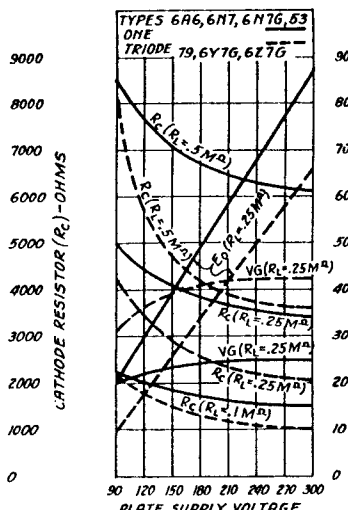

FIG. P5

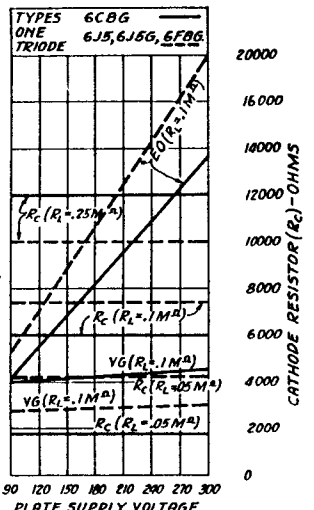

FIG. P6

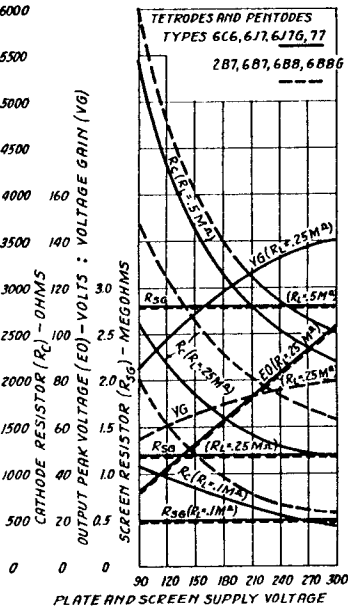

FIG. P7

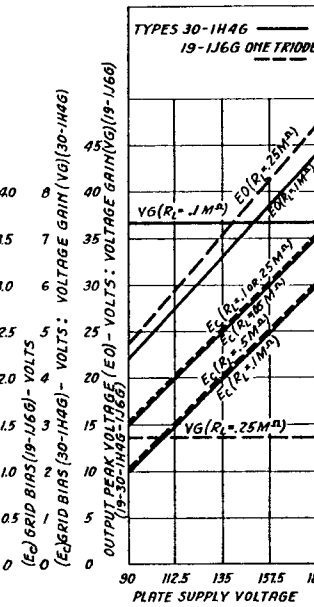

FIG. P8

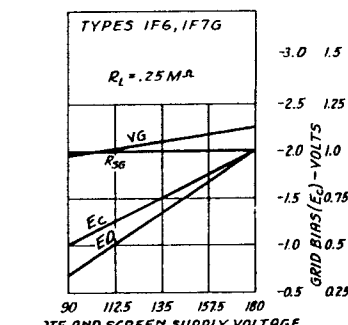

FIG. P9

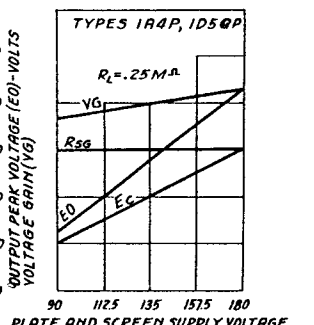

FIG. P10

| Type No. | Structure | Cathode | Use |
|-----------|-------------------|-------------------|-----------------------------|
| 00A | Triode | 5.0 volt Filament | Detector or Amplifier |
| 01A | Triode | 5.0 volt Filament | Detector or Amplifier |
| 024 | Twin Diode | Cold | Full Wave Rectifier |
| 0Z4G | Twin Diode | Cold | Full Wave Rectifier |
| 1A4-T | Tetrode | 2.0 volt Filament | Remote Cutoff Amplifier |
| 1A6 | Heptode | 2.0 volt Filament | Frequency Converter |
| 1B4/951 | Pentode | 2.0 volt Filament | Detector or Amplifier |
| 1B5/255 | Duo-Diode Triode | 2.0 volt Filament | Detector Amplifier |
| 1C6 | Heptode | 2.0 volt Filament | Frequency Converter |
| 1C7G | Heptode | 2.0 volt Filament | Frequency Converter |
| 1D5C-P | Pentode | 2.0 volt Filament | Remote Cutoff Amplifier |
| 1D7G | Heptode | 2.0 volt Filament | Frequency Converter |
| 1E5C-P | Pentode | 2.0 volt Filament | Detector or Amplifier |
| 1E7G | Twin Pentode | 2.0 volt Filament | Power Amplifier |
| 1F4 | Pentode | 2.0 volt Filament | Power Amplifier |
| 1F5G | Pentode | 2.0 volt Filament | Power Amplifier |
| 1F6 | Duo-Diode Pentode | 2.0 volt Filament | Detector Amplifier |
| 1F7G | Duo-Diode Pentode | 2.0 volt Filament | Detector Amplifier |
| 1G5G | Pentode | 2.0 volt Filament | Power Amplifier |
| 1H4G | Triode | 2.0 volt Filament | Detector or Amplifier |
| 1H6G | Duo-Diode Triode | 2.0 volt Filament | Detector Amplifier |
| 1J5G | Pentode | 2.0 volt Filament | Power Amplifier |
| 1J6G | Twin Triode | 2.0 volt Filament | Power Amplifier |
| 1-V | Diode | 6.3 volt Heater | Half Wave Rectifier |
| 2A3 | Triode | 2.5 volt Filament | Power Amplifier |
| 2A3H | Triode | 2.5 volt Heater | Power Amplifier |
| 2A5 | Pentode | 2.5 volt Heater | Power Amplifier |
| 2A6 | Duo-Diode Triode | 2.5 volt Heater | Detector Amplifier |
| 2A7 | Heptode | 2.5 volt Heater | Frequency Converter |
| 2B7 | Duo-Diode Pentode | 2.5 volt Heater | Detector Amplifier |
| 5T4 | Twin Diode | 5.0 volt Filament | Full Wave Rectifier |
| 5U4G | Twin Diode | 5.0 volt Filament | Full Wave Rectifier |
| 5V4G | Twin Diode | 5.0 volt Heater | Full Wave Rectifier |
| 5W4 | Twin Diode | 5.0 volt Filament | Full Wave Rectifier |
| 5W4G | Twin Diode | 5.0 volt Filament | Full Wave Rectifier |
| 5X4G | Twin Diode | 5.0 volt Filament | Full Wave Rectifier |
| 5Y3G | Twin Diode | 5.0 volt Filament | Full Wave Rectifier |
| 5Y4G | Twin Diode | 5.0 volt Filament | Full Wave Rectifier |
| 5Z3 | Twin Diode | 5.0 volt Filament | Full Wave Rectifier |
| 5Z4 | Twin Diode | 5.0 volt Heater | Full Wave Rectifier |
| 6A3 | Triode | 6.3 volt Filament | Power Amplifier |
| 6A4/LA | Pentode | 6.3 volt Filament | Power Amplifier |
| 6A5G | Triode | 6.3 volt Heater | Power Amplifier |
| 6A6 | Twin Triode | 6.3 volt Heater | Power Amplifier |
| 6A7 | Heptode | 6.3 volt Heater | Frequency Converter |
| 6A8 | Heptode | 6.3 volt Heater | Frequency Converter |
| 6A8C | Heptode | 6.3 volt Heater | Frequency Converter |
| 6AB5 | Cathode Ray | 6.3 volt Heater | Tuning Indicator |
| 6AC5G | Triode | 6.3 volt Heater | Power Amplifier |
| 6B4G | Triode | 6.3 volt Filament | Power Amplifier |
| 6B5 | Duo-Triode | 6.3 volt Heater | Power Amplifier |
| 6B6G | Duo-Diode Triode | 6.3 volt Heater | Detector Amplifier |
| 6B7 | Duo-Diode Pentode | 6.3 volt Heater | Detector Amplifier |
| 6B8 | Duo-Diode Pentode | 6.3 volt Heater | Detector Amplifier |
| 6B8G | Duo-Diode Pentode | 6.3 volt Heater | Detector Amplifier |
| 6C5 | Triode | 6.3 volt Heater | Detector or Amplifier |
| 6C5G | Triode | 6.3 volt Heater | Detector or Amplifier |
| 6C6 | Pentode | 6.3 volt Heater | Detector or Amplifier |
| 6C8G | Twin Triode | 6.3 volt Heater | Amplifier or Phase Inverter |
| 6D6 | Pentode | 6.3 volt Heater | Remote Cutoff Amplifier |
| 6D8G | Heptode | 6.3 volt Heater | Frequency Converter |
| 6E5 | Cathode Ray | 6.3 volt Heater | Tuning Indicator |
| 6E6 | Twin Triode | 6.3 volt Heater | Power Amplifier |
| 6F5 | Triode | 6.3 volt Heater | Amplifier |
| 6F5G | Triode | 6.3 volt Heater | Amplifier |
| 6F6 | Pentode | 6.3 volt Heater | Power Amplifier |
| 6F6G | Pentode | 6.3 volt Heater | Power Amplifier |
| 6F7 | Triode Pentode | 6.3 volt Heater | Amplifier or Converter |
| 6F8G | Twin Triode | 6.3 volt Heater | Amplifier |
| 6G5/6H5 | Cathode Ray | 6.3 volt Heater | Tuning Indicator |
| 6G6G | Pentode | 6.3 volt Heater | Power Amplifier |
| 6H6 | Twin Diode | 6.3 volt Heater | Detector |
| 6H6G | Twin Diode | 6.3 volt Heater | Detector |
| 6J5 | Triode | 6.3 volt Heater | Amplifier |
| 6J5G | Triode | 6.3 volt Heater | Amplifier |
| 6J7 | Pentode | 6.3 volt Heater | Detector or Amplifier |
| 6J7G | Pentode | 6.3 volt Heater | Detector or Amplifier |
| 6J8G | Triode Heptode | 6.3 volt Heater | Frequency Converter |
| 6K5G | Triode | 6.3 volt Heater | Amplifier |
| 6K6G | Pentode | 6.3 volt Heater | Power Amplifier |
| 6K7 | Pentode | 6.3 volt Heater | Remote Cutoff Amplifier |
| 6K7G | Pentode | 6.3 volt Heater | Remote Cutoff Amplifier |
| 6L5G | Triode | 6.3 volt Heater | Detector or Amplifier |
| 6L6 | Tetrode | 6.3 volt Heater | Power Amplifier |
| 6L6G | Tetrode | 6.3 volt Heater | Power Amplifier |
| 6L7 | Heptode | 6.3 volt Heater | Mixer or Amplifier |
| 6L7G | Heptode | 6.3 volt Heater | Mixer or Amplifier |
| 6N5 | Cathode Ray | 6.3 volt Heater | Tuning Indicator |
| 6N6G | Duo-Triode | 6.3 volt Heater | Power Amplifier |
| 6N6MG | Duo-Triode | 6.3 volt Heater | Power Amplifier |
| 6N7 | Twin Triode | 6.3 volt Heater | Power Amplifier |
| 6N7G | Twin Triode | 6.3 volt Heater | Power Amplifier |
| 6P7G | Triode Pentode | 6.3 volt Heater | Amplifier or Converter |
| 6Q7 | Duo-Diode Triode | 6.3 volt Heater | Detector Amplifier |
| 6Q7G | Duo-Diode Triode | 6.3 volt Heater | Detector Amplifier |
| 6R7 | Duo-Diode Triode | 6.3 volt Heater | Detector Amplifier |
| 6R7G | Duo-Diode Triode | 6.3 volt Heater | Detector Amplifier |
| 6S7G | Pentode | 6.3 volt Heater | Remote Cutoff Amplifier |
| 6T5 | Cathode Ray | 6.3 volt Heater | Tuning Indicator |
| 6T7G/6Q6G | Duo-Diode Triode | 6.3 volt Heater | Detector Amplifier |

RAYTHEON AMATEUR TUBES

| Type No. | Structure | Cathode | Use |
|----------|------------------|--------------------|-----------------------------|
| 6U5 | Cathode Ray | 6.3 volt Heater | Tuning Indicator |
| 6U7G | Pentode | 6.3 volt Heater | Remote Cutoff Amplifier |
| 6V6 | Tetrode | 6.3 volt Heater | Power Amplifier |
| 6V6G | Tetrode | 6.3 volt Heater | Power Amplifier |
| 6V7G | Duo-Diode Triode | 6.3 volt Heater | Detector Amplifier |
| 6W5G | Twin Diode | 6.3 volt Heater | Full Wave Rectifier |
| 6X5 | Twin Diode | 6.3 volt Heater | Full Wave Rectifier |
| 6X5G | Twin Diode | 6.3 volt Heater | Full Wave Rectifier |
| 6Y6G | Pentode | 6.3 volt Heater | Power Amplifier |
| 6Y7G | Twin Triode | 6.3 volt Heater | Power Amplifier |
| 6Z7G | Twin Triode | 6.3 volt Heater | Power Amplifier |
| 6ZY5G | Twin Diode | 6.3 volt Heater | Full Wave Rectifier |
| 10 | Triode | 7.5 volt Filament | Power Amplifier |
| 12A | Triode | 5.0 volt Filament | Detector or Amplifier |
| 12A5 | Pentode | 12.6/6.3 v. Heater | Power Amplifier |
| 12A7 | Diode Pentode | 12.6 volt Heater | Rectifier Power Amplifier |
| 12Z3 | Diode | 12.6 volt Heater | Half Wave Rectifier |
| 15 | Pentode | 2.0 volt Heater | Amplifier |
| 19 | Twin Triode | 2.0 volt Filament | Power Amplifier |
| 20 | Triode | 3.3 volt Filament | Power Amplifier |
| 22 | Tetrode | 3.3 volt Filament | Amplifier |
| 24A | Tetrode | 2.5 volt Heater | Detector or Amplifier |
| 25A6 | Pentode | 25 volt Heater | Power Amplifier |
| 25A6G | Pentode | 25 volt Heater | Power Amplifier |
| 25A7G | Diode Pentode | 25 volt Heater | Rectifier Power Amplifier |
| 25B6G | Pentode | 25 volt Heater | Power Amplifier |
| 25L6 | Tetrode | 25 volt Heater | Power Amplifier |
| 25L6G | Tetrode | 25 volt Heater | Power Amplifier |
| 25Z5 | Twin Diode | 25 volt Heater | Rectifier Voltage Doubler |
| 25Z6 | Twin Diode | 25 volt Heater | Rectifier Voltage Doubler |
| 25Z6G | Twin Diode | 25 volt Heater | Rectifier Voltage Doubler |
| 26 | Triode | 1.5 volt Filament | Amplifier |
| 27 | Triode | 2.5 volt Heater | Detector or Amplifier |
| 30 | Triode | 2.0 volt Filament | Detector or Amplifier |
| 31 | Triode | 2.0 volt Filament | Power Amplifier |
| 32 | Tetrode | 2.0 volt Filament | Detector or Amplifier |
| 33 | Pentode | 2.0 volt Filament | Power Amplifier |
| 34 | Pentode | 2.0 volt Filament | Remote Cutoff Amplifier |
| 35/51 | Tetrode | 2.5 volt Heater | Remote Cutoff Amplifier |
| 36 | Tetrode | 6.3 volt Heater | Detector or Amplifier |
| 37 | Triode | 6.3 volt Heater | Detector or Amplifier |
| 38 | Pentode | 6.3 volt Heater | Power Amplifier |
| 39/44 | Pentode | 6.3 volt Heater | Remote Cutoff Amplifier |
| 40 | Triode | 5.0 volt Filament | Amplifier |
| 41 | Pentode | 6.3 volt Heater | Power Amplifier |
| 42 | Pentode | 6.3 volt Heater | Power Amplifier |
| 43 | Pentode | 2.5 volt Heater | Power Amplifier |
| 45 | Triode | 2.5 volt Filament | Power Amplifier |
| 46 | Dual Grid Triode | 2.5 volt Filament | Power Amplifier |
| 47 | Pentode | 2.5 volt Filament | Power Amplifier |
| 48 | Pentode | 3.0 volt Heater | Power Amplifier |
| 49 | Dual Grid Triode | 2.0 volt Filament | Power Amplifier |
| 50 | Triode | 7.5 volt Filament | Power Amplifier |
| 52 | Dual Grid Triode | 6.3 volt Filament | Power Amplifier |
| 53 | Twin Triode | 2.5 volt Heater | Power Amplifier |
| 55 | Duo-Diode Triode | 2.5 volt Heater | Detector Amplifier |
| 56 | Triode | 2.5 volt Heater | Detector or Amplifier |
| 57 | Pentode | 2.5 volt Heater | Detector or Amplifier |
| 58 | Pentode | 2.5 volt Heater | Remote Cutoff Amplifier |
| 59 | Pentode | 2.5 volt Heater | Triple Grid Power Amplifier |
| 71A | Triode | 5.0 volt Filament | Power Amplifier |
| 75 | Duo-Diode Triode | 6.3 volt Heater | Detector Amplifier |
| 76 | Triode | 6.3 volt Heater | Detector or Amplifier |
| 77 | Pentode | 6.3 volt Heater | Detector or Amplifier |
| 78 | Pentode | 6.3 volt Heater | Remote Cutoff Amplifier |
| 79 | Twin Triode | 6.3 volt Heater | Power Amplifier |
| 80 | Twin Diode | 5.0 volt Filament | Full Wave Rectifier |
| 81 | Diode | 7.5 volt Filament | Half Wave Rectifier |
| 82 | Twin Diode | 2.5 volt Filament | Full Wave Rectifier |
| 83 | Twin Diode | 5.0 volt Filament | Full Wave Rectifier |
| 83V | Twin Diode | 5.0 volt Heater | Full Wave Rectifier |
| 84/6Z4 | Twin Diode | 6.3 volt Heater | Full Wave Rectifier |
| 85 | Duo-Diode Triode | 6.3 volt Heater | Detector Amplifier |
| 89 | Pentode | 6.3 volt Heater | Triple Grid Power Amplifier |
| 950 | Pentode | 2.0 volt Filament | Power Amplifier |
| BA | Twin Diode | Cold | Full Wave Rectifier |
| BH | Twin Diode | Cold | Full Wave Rectifier |
| BR | Diode | Cold | Half Wave Rectifier |
| WD-11 | Triode | 1.1 volt Filament | Detector or Amplifier |
| WX-12 | Triode | 1.1 volt Filament | Detector or Amplifier |
| V-99 | Triode | 3.3 volt Filament | Detector or Amplifier |
| X-99 | Triode | 3.3 volt Filament | Detector or Amplifier |

AUTOMOTIVE TYPES

| Type No. | Volts | Amps. | C.P. | Bulb | Base | Bead Color | L.C.L. Inches | M.O.L. Inches |
|----------|-------|-------|------|---------|--------------|------------|---------------|---------------|
| R51 | 6-8 | 0.2 | 1.0 | G-3 1/2 | Min. Bayonet | White | 1/2 | 15/16 |
| R55 | 6-8 | 0.4 | 1.5 | G-4 1/2 | Min. Bayonet | White | 1/2 | 1 1/16 |
| R40 | | | | | R50 | R51 | | R55 |
| R41 | | | | | | | | |
| R42 | | | | | | | | |
| R46 | | | | | | | | |
| R48 | | | | | | | | |
| R292 | | | | | | | | |
| R40A | | | | | | | | |
| R43 | | | | | | | | |
| R44 | | | | | | | | |
| R45 | | | | | | | | |
| R49 | | | | | | | | |
| R49A | | | | | | | | |

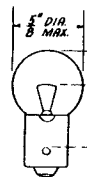
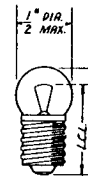
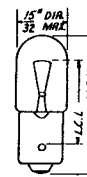
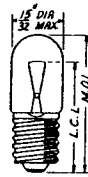

R 40
R 41
R 42
R 46
R 48
R 292

R 40 A
R 43
R 44
R 45
R 49
R 49 A
R 292 A

RAYTHEON TUBES FOR SPECIAL APPLICATIONS

Raytheon develops and manufactures tubes of all kinds for industrial and special applications and has facilities for rendering engineering service on the use of such tubes.

Included in these special types are rectifiers ranging in size from small battery charging bulbs to high power industrial rectifiers, thyratrons of both the gas filled and mercury vapor types and permatrons.

The permatron is a new form of gas or vapor filled tube in which the breakdown voltage is controlled by means of a magnetic field instead of a grid.

Further information on these types may be obtained on request.

RAYTHEON MINIATURE LAMPS

RADIO PANEL TYPES

| Type No. | Volts | Amps. | C.P. | Bulb | Base | Bead Color | L.C.L. Inches | M.O.L. Inches |
|----------|-------|-------|------|---------|--------------|------------|---------------|---------------|
| R40 | 6-8 | 0.15 | 0.5 | T-3 1/4 | Min. Screw | Brown | 29/32 | 1 1/8 |
| R40-A | 6-8 | 0.15 | 0.5 | T-3 1/4 | Min. Bayonet | Brown | 23/32 | 1 1/8 |
| R41 | 2.5 | 0.5 | 0.5 | T-3 1/4 | Min. Screw | White | 29/32 | 1 1/8 |
| R42 | 3.2 | 0.5 | 0.75 | T-3 1/4 | Min. Screw | Green | 29/32 | 1 1/8 |
| R43 | 2.5 | 0.5 | 0.5 | T-3 1/4 | Min. Bayonet | White | 23/32 | 1 1/8 |
| R44 | 6-8 | 0.25 | 0.8 | T-3 1/4 | Min. Bayonet | Blue | 23/32 | 1 1/8 |
| R45 | 3.2 | 0.5 | 0.75 | T-3 1/4 | Min. Bayonet | Green | 23/32 | 1 1/8 |
| R46 | 6-8 | 0.25 | 0.8 | T-3 1/4 | Min. Screw | Blue | 29/32 | 1 1/8 |
| R48 | 2.0 | 0.06 | 0.03 | T-3 1/4 | Min. Screw | Pink | 29/32 | 1 1/8 |
| R49 | 2.0 | 0.06 | 0.03 | T-3 1/4 | Min. Bayonet | Pink | 23/32 | 1 1/8 |
| R49-A | 2.1 | 0.12 | 0.07 | T-3 1/4 | Min. Bayonet | White | 23/32 | 1 1/8 |
| R50 | 6-8 | 0.2 | 1.0 | G-3 1/2 | Min. Screw | White | 23/32 | 15/16 |
| R292 | 2.9 | 0.17 | 0.3 | T-3 1/4 | Min. Screw | White | 29/32 | 1 1/8 |
| R292A | 2.9 | 0.17 | 0.3 | T-3 1/4 | Min. Bayonet | White | 23/32 | 1 1/8 |

— NOTES —

— NOTES —

— NOTES —

**PLATE COLORS OF RAYTHEON
AMATEUR TUBES AT RATED
DISSIPATION**

| Type | Watts Plate Dissipation | Color |
|---|----------------------------|--------------|
| RK-10 | 15 | No Color |
| RK-11 | 25 | No Color |
| RK-12 | 25 | No Color |
| RK-18 | 40 | Light Cherry |
| RK-19 | — | No Color |
| RK-20A | 40 | No Color |
| RK-21 | — | No Color |
| RK-22 | — | No Color |
| RK-23 | 10 | No Color |
| RK-24 | 1.5 | No Color |
| RK-25 | 10 | No Color |
| RK-25B | 10 | No Color |
| RK-28 | 100 | Light Cherry |
| RK-30 | 35 | Dull Cherry |
| RK-31 | 40 | Light Cherry |
| RK-32 | 50 | Orange |
| RK-33 | 2.5 (one plate) | No Color |
| RK-34 | 10 (both plates) | No Color |
| RK-35 | 50 | Lt. Yel. Red |
| RK-36 | 100 | Lt. Yel. Red |
| RK-37 | 50 | Lt. Yel. Red |
| RK-38 | 100 | Lt. Yel. Red |
| RK-39 | 25 | No Color |
| RK-41 | 25 | No Color |
| RK-42 | — | No Color |
| RK-43 | — | No Color |
| RK-44 | 12 | No Color |
| RK-45 | 10 | No Color |
| RK-46 | 40 | No Color |
| RK-47 | 50 | Dull Cherry |
| at center of plate if viewed in the dark. | | |
| RK-48 | 100 | Light Red |
| RK-49 | 21 | No Color |
| RK-51 | 60 | No Color |
| RK-52 | 60 | No Color |
| RK-100 | 15 | No Color |
| 841 | 12 | No Color |
| 842 | 12 | No Color |
| 864 | — | No Color |
| 866 | — | No Color |
| 866A | — | No Color |
| 872A | — | No Color |

For colors and temperature equivalents see opposite page.

COLOR SCALE FOR PLATE OPERATING TEMPERATURES

FOR

RAYTHEON AMATEUR TUBES

**COLORS &
APPROX. TEMPERATURE
EQUIVALENTS**

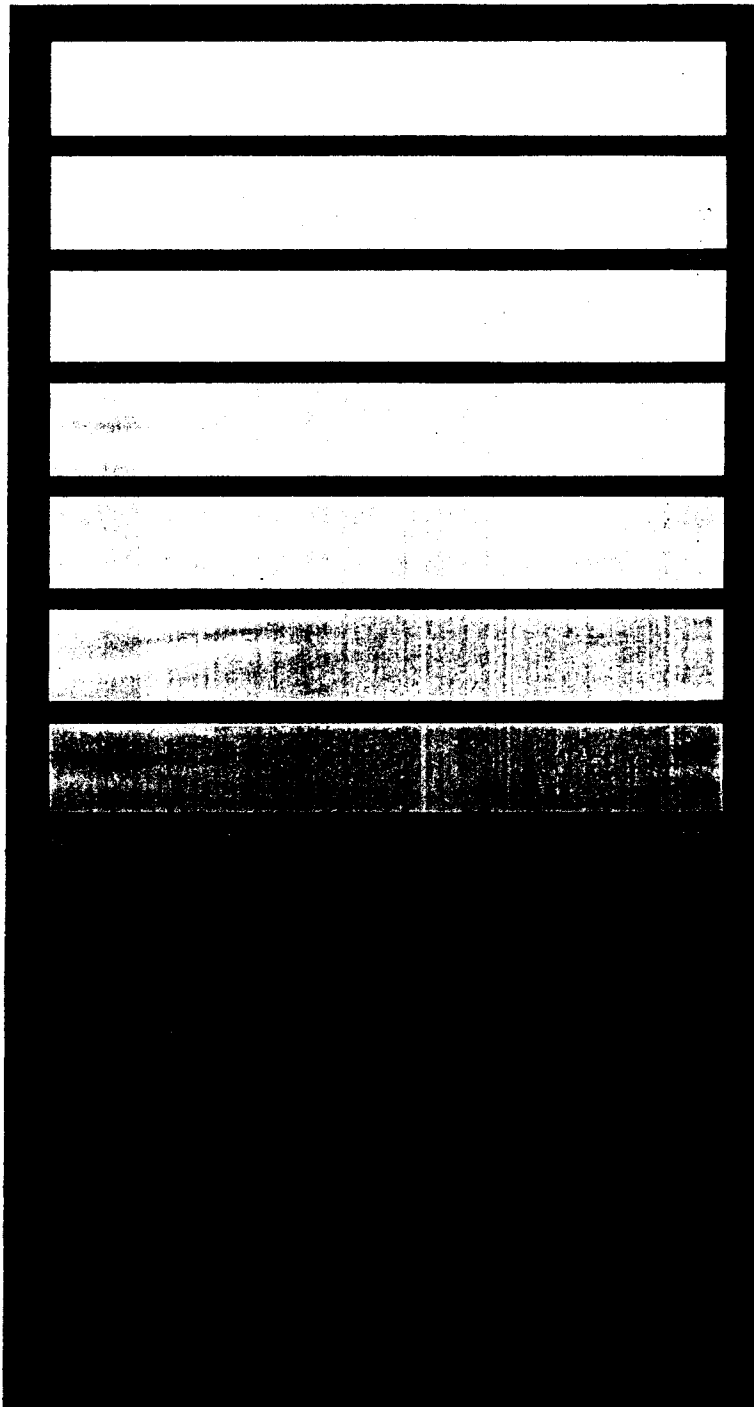

| | | |
|----------|-------------------|----------|
| 1300° C. | White | 2370° F. |
| 1200° C. | Yellowish-White | 2190° F. |
| 1100° C. | Light Orange | 2010° F. |
| 1000° C. | Orange | 1830° F. |
| 950° C. | Lt. Yellowish-Red | 1740° F. |
| 900° C. | Yellowish-Red | 1650° F. |
| 850° C. | Light Red | 1560° F. |
| 800° C. | Light Cherry | 1470° F. |
| 750° C. | Cherry | 1380° F. |
| 700° C. | Dull Cherry | 1290° F. |
| 650° C. | Dull Red | 1200° F. |
| 600° C. | Brown Red | 1110° F. |

A list of types and color temperatures for plates operated at rated dissipation appears on the opposite page.

Lithographic color reproduction above must be considered approximate.

RAYTHEON