

# Radio Broadcast's

---

---

## *KNOCK-OUT RECEIVERS*

---

---

### A Complete Description—

*With Notes by Arthur H. Lynch*

#### HOW TO MAKE

- A Knock-Out One-Tube Receiver
- A Knock-Out Two-Tube Receiver
- A Knock-Out Three-Tube Receiver
- A Knock-Out One-Tube Reflex with Sodian Detector
- A Knock-Out One-Tube Receiver with a Vario-Transformer
- A Roberts Two-Tube Receiver

---

---

*Price, Fifty Cents*

---

---

DOUBLEDAY, PAGE & COMPANY

GARDEN CITY

NEW YORK



## By Way of Introduction

**B**ETWEEN the covers of this little book you will find radio receiving circuits of proved merit. They have been prepared by leaders of the advance in receiving engineering—men whose services are priceless and whose experience is very broad.

All of the work on the series of articles contained here has been done under my direction by men who are specialists in their particular lines and whose valuable services are placed at the disposal of readers of RADIO BROADCAST.

You may find this work a little loose-jointed from a literary standpoint, but that is necessarily so, because the material published here has been printed from the same plates used in printing the numbers of RADIO BROADCAST in which it first saw the light of day.

The reason for this booklet is to enable those readers who have found it impossible to procure certain back numbers of the magazine to have a complete file of the material on the truly remarkable "knock-out" receivers.

---

**I**N publishing this series, we wish to express our appreciation for the unstinted effort of those engineers whose work behind the scenes has made it possible.

We wish to thank Schloemilch and Van Bronk, the men in whose favor the fundamental patent on the knock-out single tube receiver was issued. And our thanks are also due—

To John R. Meagher, whose work with Mr. Harkness resulted in the publication of the first article in our November, 1923, number.

To Dr. L. M. Hull of the Radio Frequency Laboratories at Boonton, N. J., whose valuable research work has helped us to determine which circuits to use and which not to use.

To Zeh Bouck, Editor of the RADIO BROADCAST Lab Department, who built a great many of the various models and who so ably described them.

To C. H. Brown, who suggested the use of the spiderweb type transformers.

To John V. L. Hogan, Consulting Engineer of the Connecticut Telephone & Electric Co., Meriden, Conn., who spent many hours in the editor's home working on the application of the Sodian tube to this reflex circuit.

To Walter VanB. Roberts of the Palmer Physical Laboratory, Princeton University, for his excellent work in applying regeneration without radiation to this excellent circuit.

To that group of investigators, who for reasons best known to themselves, do not care to have their names appear here, and

To those readers of RADIO BROADCAST who have written us such encouraging letters in appreciation of the work we are doing on this form of reception.

*Arthur H. Synchron*

Editor, RADIO BROADCAST.



## Table of Contents

	PAGE
HOW TO MAKE A ONE-TUBE KNOCK-OUT SET - - - - <i>Kenneth Harkness</i>	2
<i>Note</i> —USE OF HONEYCOMB COILS FOR T <sub>1</sub> AND T <sub>2</sub> - - - - -	12
THE ONE-TUBE REFLEX WITH THE BALLANTINE VARIO-TRANSFORMER <i>Dr. L. M. Hull and Zeb Bouck</i>	13
<i>Note</i> —SELECTIVITY: COMPARISON OF THE ONE-TUBE KNOCK-OUT TO THE ROBERTS CIRCUIT - - - - -	16
<i>Note</i> —USING A COUNTERPOISE TO INCREASE SELECTIVITY - - - - -	16
ADDING ONE STAGE OF AUDIO TO THE KNOCK-OUT - - - - <i>Editor, The Grid</i>	17
SPIDERWEBS AND THE KNOCK-OUT REFLEX - - - - - <i>C. H. Brown</i>	18
HOW TO CONNECT TRANSFORMERS PROPERLY - - - - <i>R. B. Lab. Department</i>	19
USING THE SODION TUBE IN THE ONE-TUBE REFLEX - - - - -	20
FIXED CRYSTALS AND THEIR USE - - - - - <i>R. B. Lab. Department</i>	23
COMBINING REGENERATION, NEUTRALIZATION, TUNED RADIO-FREQUENCY AND AUDIO AMPLIFICATION WITH TWO TUBES - - - - <i>Walter VanB. Roberts</i>	24
HOW TO BUILD THE ROBERTS CIRCUIT BEHIND A PANEL - - - - <i>Walter VanB. Roberts</i>	29
HOW TO MAKE THE THREE-TUBE KNOCK-OUT - - - - - <i>Zeb Bouck</i>	33
A GALLERY OF FINISHED THREE-TUBE MODELS - - - - <i>R. B. Lab. Department</i>	39



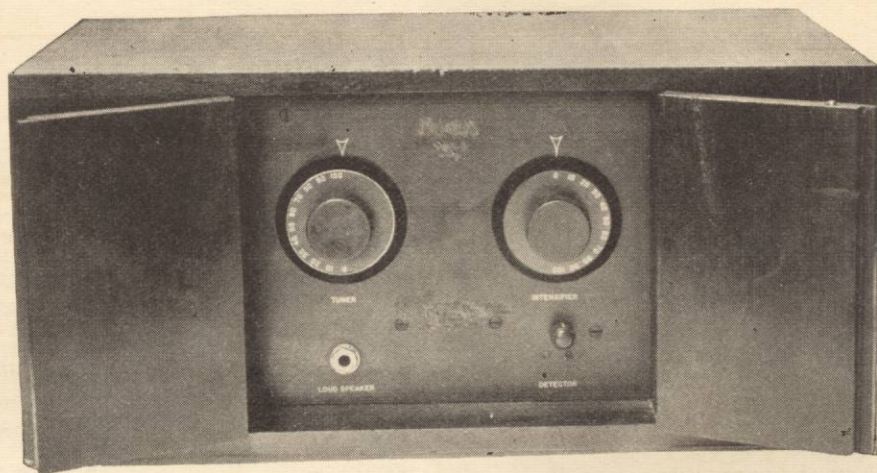

#### THE COMPLETE OUTFIT

Everything including the A and B batteries may be placed in an attractive cabinet. Some idea of the simplicity of operation may be had from a glance at the panel

## How to Make a One-tube Reflex Set That's a "Knock-Out"

Described in a Most Comprehensive Manner, with Complete Instructions for Building and Operating It. It Should Operate a Loud-Speaker over a Crystal Range and It Is not a "Bloop"

By KENNETH HARKNESS

This article first saw the light of day in our November 1923 number. Since that time we have designed and described various modifications of this fundamental circuit and several new developments are in the fire. As soon as the results we obtain are satisfactory these sets will be described. In this number there are two modifications of the receiver described below. Both are improvements. By confining our efforts to a single fundamental idea it is possible to provide our readers with the most reliable data on receivers *without making it necessary to discard any material previously purchased.*

We have had so many letters from enthusiastic supporters of this receiver and so many requests for extra copies of the November number that we feel that its reprinting will fill a rapidly growing need. The boiled-down digest of our readers' comment shows very plainly that the receiver really is what we have called it—a knock-out.—THE EDITOR.

**W**E HAVE often heard of one-tube receivers that will actuate a loud speaker, but seldom do we have the experience of listening to such a performance; and in radio—hearing is believing—so we are justly skeptical of these "wonder sets."

Indeed, the super-regenerative "flivver" receiver was the first loud-speaking one-tube set\* we had occasion to witness in actual operation, and although it made a remarkable showing in reproducing local stations, distant

\*See "Operating a Loud Speaker on One Tube Without Batteries" in RADIO BROADCAST for June, 1923.

reception appeared impossible and some rather complicated knob and dial juggling was required in the process of tuning.

Immediately after the super-regenerative craze died down, we were deluged with hashed-up versions of revived and rejuvenated but nevertheless ancient reflex circuits; but until recently we were still looking for a demonstration of a one-tube set that would make a loud speaker "percolate."

For this reason we spent many days and nights in an effort to produce such a single-tube receiver. Our work has resulted in an outfit that is simple and inexpensive to build, easy to install and operate as well as being compact



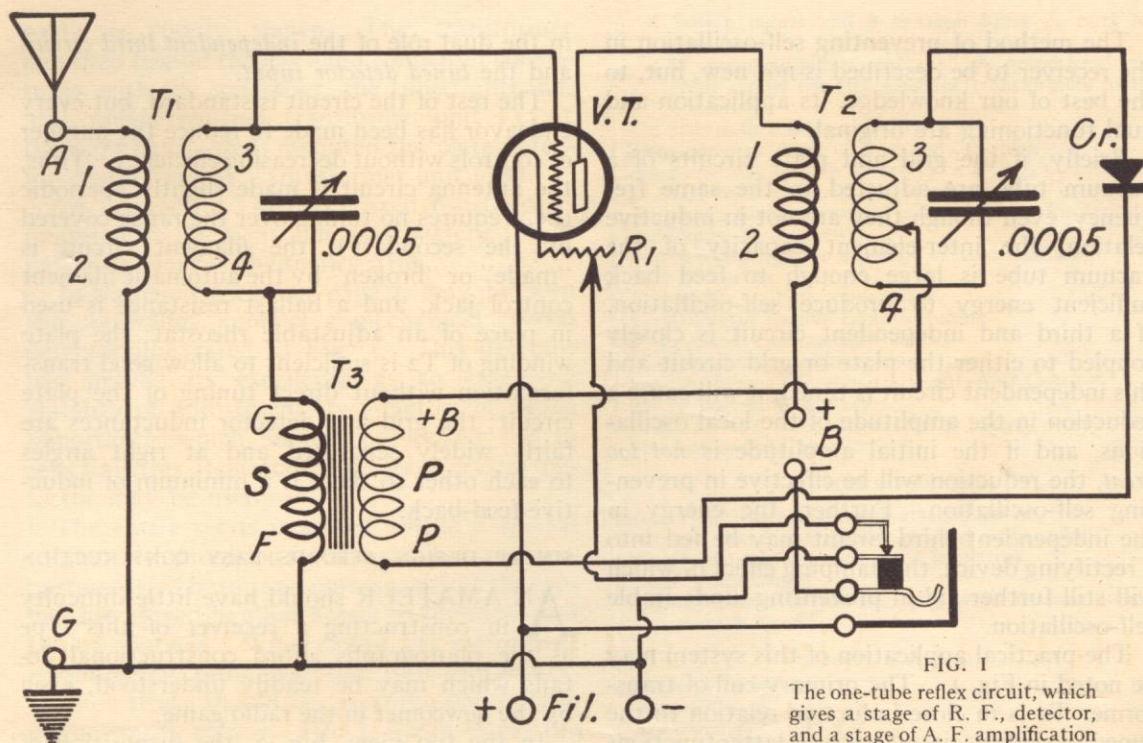

FIG. 1  
The one-tube reflex circuit, which gives a stage of R. F., detector, and a stage of A. F. amplification

and portable. It will function with any kind of receiving tube now on the market and will operate a loud speaker over distances about equal to those it is possible to hear with the telephones on an ordinary crystal receiver. When used with a headset it is capable of very long distance reception, extremely sharp tuning, and exceptionally clear reproduction of speech and music.

The receiver is essentially a one-tube reflex outfit, but involves certain modifications that make for efficiency, sensitivity, volume, clarity, and ease of control. It is:

*Efficient*—because the one tube is made to do double duty and because an improved circuit with correct constants is employed.

*Sensitive*—because a stage of *tuned* radio-frequency amplification is provided before the *tuned* detector circuit.

*Volume*—because a stage of audio-frequency amplification is used to amplify the rectified impulses and because *both* the radio-frequency amplifying and rectifying circuits are *tuned*—giving maximum amplification with corresponding selectivity.

*Clear*—because a crystal is used for rectification: and because, when properly adjusted, the vacuum tube does not oscillate and the

howling and squealing so noticeable in regenerative receivers is totally absent.

So far, not so bad, eh?

METHOD OF PREVENTING SELF-OSCILLATION

ORDINARILY in a reflex circuit the tendency toward self-oscillation is so great that a potentiometer or similar device must be employed to impress a positive charge on the grid so that the resultant grid current will prevent self-oscillation.\* In a plain radio-frequency amplifier this would be quite satisfactory, but when it is desired to use the same tube for audio-frequency amplification it is necessary to operate the grid at a *negative* potential or else the A. F. amplification will be *nil!* It is evident then that reflex systems utilizing a potentiometer stabilizer are out of the question.

We could employ reversed inductive or capacitive feed-back to balance the self-oscillations, but each of these systems has certain disadvantages; especially in a circuit having a variable resistance element such as a mineral rectifier.† The adjustment would necessarily be tricky and unstable.

\*See "Radio-Frequency Amplification Without Distortion or Reradiation," RADIO BROADCAST for July, 1923, page 214.

†Several fixed crystals, such as the Erla and Pyratek have been used in the R. B. Lab with great satisfaction.



The method of preventing self-oscillation in the receiver to be described is not new, but, to the best of our knowledge, its application and dual functioning are original.

Briefly, if the grid and plate circuits of a vacuum tube are adjusted to the same frequency, even though they are not in inductive relation, the inter-element capacity of the vacuum tube is large enough to feed back sufficient energy to produce self-oscillation. If a third and independent circuit is closely coupled to either the plate or grid circuit and this independent circuit is tuned, it will cause a reduction in the amplitude of the local oscillations, and if the initial amplitude is *not too great*, the reduction will be effective in preventing self-oscillation. Further, the energy in the independent third circuit may be fed into a rectifying device, the damping effect of which will still further aid in preventing undesirable self-oscillation.

The practical application of this system may be noted in Fig. 1. The primary coil of transformer T<sub>2</sub> is in close inductive relation to the tuned secondary circuit—which latter functions

in the dual rôle of the *independent third circuit* and the *tuned detector input*.

The rest of the circuit is standard, but every endeavor has been made to reduce the number of controls without decreasing efficiency. Thus, the antenna circuit is made slightly aperiodic (i.e., requires no tuning over the range covered by the secondary); the filament circuit is "made" or "broken" by the automatic filament control jack, and a ballast resistance is used in place of an adjustable rheostat; the plate winding of T<sub>2</sub> is sufficient to allow good transformation without direct tuning of the plate circuit; the grid and detector inductances are fairly widely separated and at right angles to each other so there is a minimum of inductive feed-back.

#### SIMPLE DESIGN AFFORDS EASY CONSTRUCTION

**A**N AMATEUR should have little difficulty in constructing a receiver of this type as the photographs afford constructional details which may be readily understood, even by the newcomer in the radio game.

In the top view, Fig. 2, the disposition of

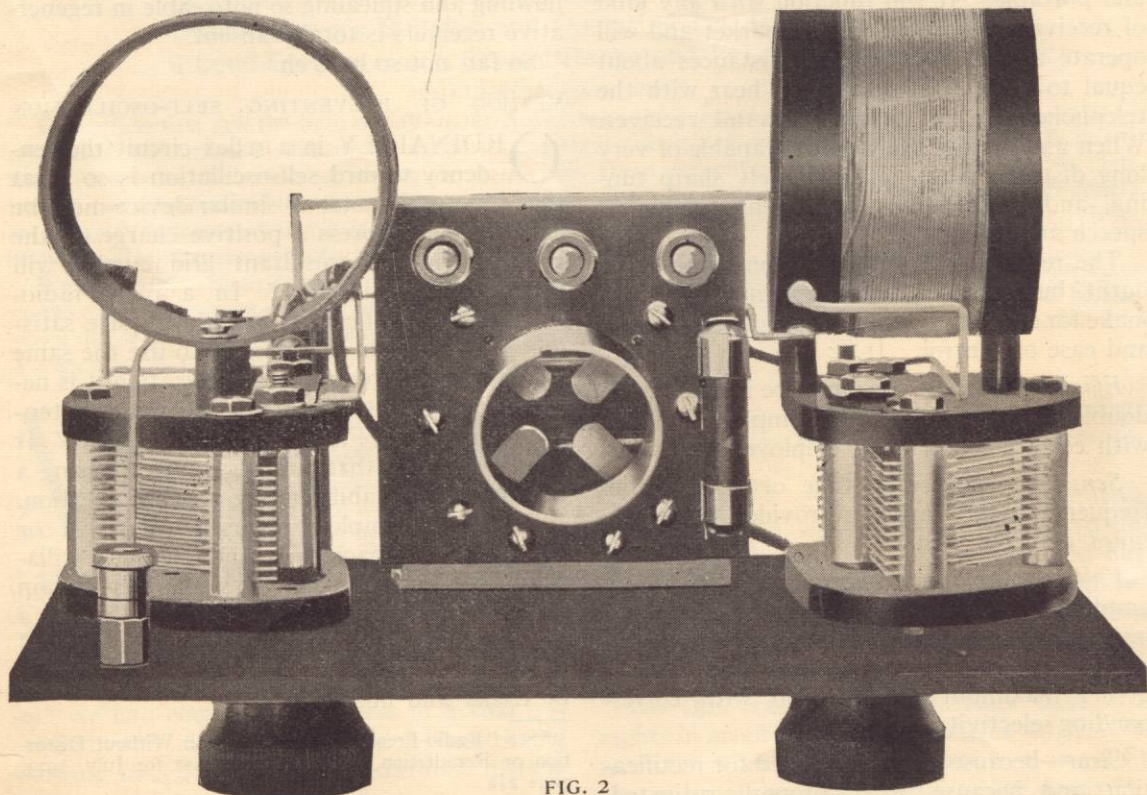

FIG. 2

This is how the receiver looks from above. Note that the two transformers (T<sub>1</sub> at the left, T<sub>2</sub> at the right) are mounted at right angles to each other



parts is clearly shown. The transformer mounted behind the left hand condenser constitutes, with the condenser, the tuned antenna, grid, radio-frequency transformer unit T<sub>1</sub>; at the right hand side is mounted the plate-detector, audio-frequency transformer unit (T<sub>2</sub>).

An "Amperite" or other fixed resistance is mounted at the right side and battery terminals in the rear of the socket strip.

In the front view, on page 2, may be seen the controlling knob of a mechanical crystal detector illustrated in Fig. 3. This detector has proved its excellence as to ease and stability of adjustment, two factors of prime importance which should be looked for in selecting this item; but any good crystal detector may be used.

The entire set is mounted within a special cabinet with provision for separate battery compartments. The top and center panels of the cabinet are hinged to allow access to the tubes and tuning controls. When closed, the instrument is completely protected from dust and injury.

Close study should be given the photograph of the empty cabinet, Fig. 4, which shows the proper measurements. It is advisable to secure all the material necessary before starting the actual assembly of this receiver.

LIST OF MATERIALS REQUIRED

- 1 Audio-frequency transformer, 4½ to 1 ratio
- 1 Panel-mounting crystal detector, mechanical adjustment preferred
- 2 Special tuned radio-frequency transformers, utilizing—
  - 2 .0004 mfd. variable condensers
  - 2 1/16" Formica forms, 2" long and 2 5/8" dia.
  - 1/4 lb. No. 28 cotton and silk insulated wire
  - 2 8" strips of 1" cambric cloth

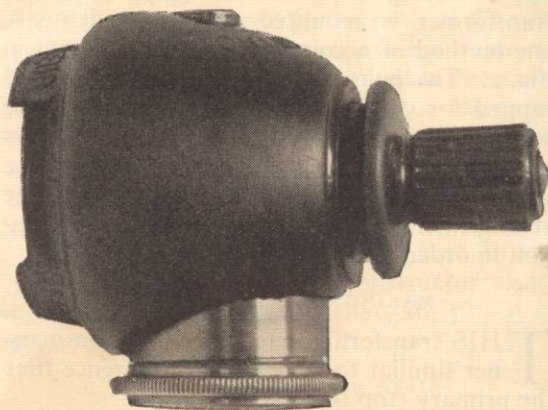

FIG. 3

A small French crystal detector which is gaining popularity in this country. Few are available at present, but they are to be marketed in quantities shortly. The cat-whisker and crystal are completely enclosed. Adjustment is accomplished by rotating the small knob shown at the right

- 8 Switch points and 8 hexagon brass 3/8" nuts for terminals
- 4 3/4" mounting pillars and 4 1" 3/8" round head machine screws for attaching the transformers to the condensers
- 2 dials to fit condenser shafts
- 1 Front panel 7 1/2" high, 9" long and 3/16" thick
- 1 Sub-panel with spun-in socket 3 1/2" x 5" x 3/16"
- 1 1" Brass angle 3 1/2" long, 3/16" stock
- 1 Automatic filament-control jack. Micarta insulation
- 5 Binding posts, 3/8" screws
- 2 Spring mountings for Amperite or fixed resistance
- 4 Feet of bus bar
- 2 Feet of No. 23 bare copper wire
- 2 Feet of small flexible cambric tubing
- 8 3/8" 3/8" round head machine screws
- 8 3/8" 3/8" flat head machine screws
- 1 Vacuum tube, preferably a UV-201-A or C-301-A
- 1 45- or 90-volt B battery
- 1 A battery of 6 volts, either storage battery or dry cells
- 1 Headset or loud speaker

ANTENNA EQUIPMENT

- Either 1 light-socket antenna attachment or 200 Feet No. 12 rubber-covered copper wire
- 3 5" glazed porcelain corrugated insulators
- 1 Lead-in insulator
- 1 Lightning arrester (not necessary when antenna attachment is used.)

CABINET MATERIAL

- 4 pieces 7 1/2" x 8 1/2" x 1/2"
- 1 Base 9 1/2" x 18" x 1/2"
- 1 Top piece 2 1/2" x 18" x 1/2"
- 1 Cover 7" x 18" x 1/2"
- 2 Doors 4 1/2" x 7 1/2" x 1/2"
- 2 Front pieces 7 1/2" x 4 1/2" x 1/2"

THE TUNED R. F. TRANSFORMER UNITS

SPECIAL care should be observed in constructing, or purchasing (if you do not care to build them), the tuned radio-frequency transformer units, as successful operation is greatly dependent upon them. For this reason exact specifications are given, and it would be well to employ similar material, follow the same constructional lines, and make all connections in accordance with instructions if duplication of the results mentioned above is expected.

Procure 1/8-lb. of number 28 single cotton (under) and single silk (upper) insulated soft-drawn copper wire and two formica forms 1/16 inch thick, 2 inches long and 2 5/8 inches in diameter.

Number 28, S.C.S.S. wire is chosen because it combines highest efficiency with exceptionally neat appearance. The double covering provides good spacing between the metallic conductors. The white cotton protective layer affords good insulation, while the silk layer is pleasing in appearance and does not allow the shellac to gather and harden between turns. The usual effect of increased distributed capacity resulting from the use of shellac or other dope



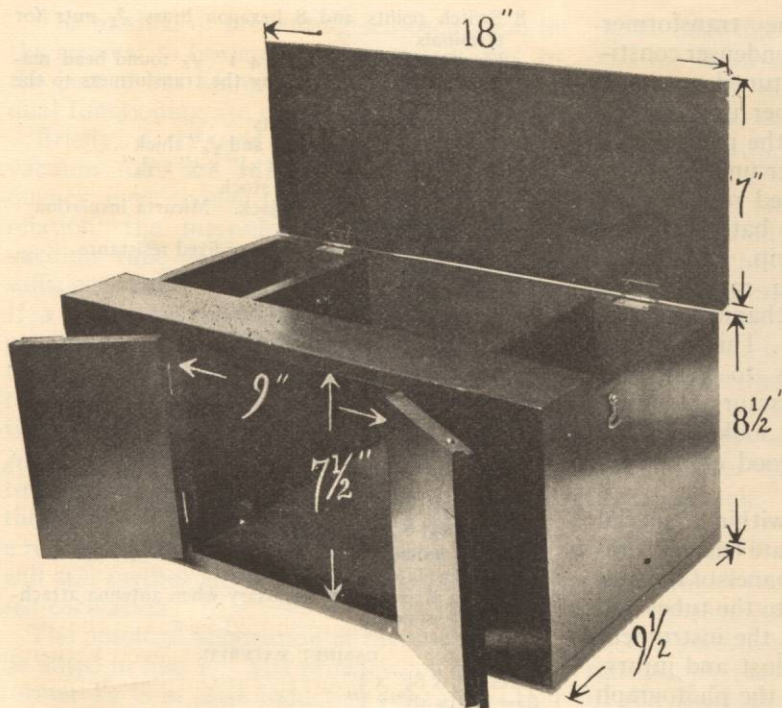

FIG. 4

The receiver slides into the middle compartment, the side sections being provided for the A and B batteries. If the constructor of the set prefers not to make the cabinet, it may be bought for a reasonable sum

on ordinary cotton covered wire is thus reduced. It is interesting to note that when coils, especially cotton covered, are not treated with some form of moisture-resisting material, a relatively great amount of moisture will be absorbed, the insulation between turns is materially reduced, and this fairly low-resistance shunt across the coil is extremely detrimental to sharp tuning.

The particular size wire is chosen because with it a relatively small length of wire is required for any given inductance and in addition the value of capacity between turns and therefore the total value of distributed capacity is lower than would be the case with heavier wire.

#### MAKING TRANSFORMER T1

ONE of the two Formica forms (see list of materials) should be provided with four terminals and two mounting screw holes, made with a No. 27 drill. The terminals are situated  $\frac{3}{4}$ " apart,  $\frac{1}{4}$ " from one edge. The mounting holes are  $\frac{1}{4}$ " from each edge on a line parallel to the axis and between the two center terminals. The terminals may consist of switch points with the heads outside and hexagon brass nuts clamping them to the form

inside. The projecting pieces of the screws are cut off and solder flowed over the nut to prevent loosening. Small holes to pass the wire should be drilled near terminals 1 and 3 (Fig. 1).

The secondary coil is wound on the form first; starting at terminal No. 3 to which the wire is soldered, 60 turns are placed evenly and tightly; the end of the wire is brought through the form at a point opposite terminal No. 4 and soldered to that terminal.

A one-inch strip of cambric cloth or other flexible sheet insulating material is wrapped over the secondary and held in place with glue.

The primary, of 15 turns, is wound on the insulating material, spaced in the center and in the same direction as the secondary.

The beginning is soldered to terminal No. 1 and the end of the coil is brought through the form at a point opposite No. 2 and soldered to that terminal.

The entire form may be given a light coat of thin shellac, collodion or airplane "dope" leaving only the terminal heads untouched for soldering. When thoroughly dry the transformer is mounted on its condenser—one method of accomplishing this is shown in Fig. 2. Two holes  $1\frac{1}{2}$ " apart may be drilled and tapped for  $\frac{6}{32}$  thread in the end plate of the variable condenser. Two  $\frac{6}{32}$  machine screws and small brass pillars are used to support the transformer away from the condenser. The arrangement should be similar to the illustration in order to retain short leads.

#### MAKING TRANSFORMER T2

THIS transformer is constructed in a manner similar to T1 with the difference that the primary (top coil) has 35 turns.

Referring to the diagram, Fig. 1, it will be seen that there are five connections to T2; the fifth connection is a center tap on the secondary and should be used only if the receiver is to be operated in the vicinity of an interfering



station. Otherwise this tap should *not* be provided as it reduces signal strength, although at the same time increasing selectivity because the damping effect of the crystal rectifier is effective over only half the inductance; if a vacuum tube detector were used, the value of this connection would be nil, the grid-filament resistance being so high. Although the volume would be diminished, selectivity would be neither greater nor less.

In most cases the lead from the positive B terminal of the primary of T<sub>3</sub> will be connected to terminal No. 4 of T<sub>2</sub> rather than to the tap.

Only a very light coat of dope or shellac should be placed on the primary of No. 2 as it is desired to keep the distributed capacity very low.

In mounting, T<sub>2</sub> should be placed on its condenser at right angles to that of T<sub>1</sub>. Fig. 5 shows the correct arrangement which should be followed.

The photographs of the back of the complete receiver (Figs. 2 and 6) indicate that the variable condensers face each other; this is not good practice because the dials must then be of different types, one reading left hand and one right hand. Therefore, in the panel layout, Fig. 7, and in the photograph of T<sub>1</sub> and T<sub>2</sub> (Fig. 5) corrections have been made so that both condensers are mounted in the same manner and both dials may be of the same type. All stated dimensions have been checked and corrected so that the drawings may be followed with perfect assurance that everything will fit.

These special transformer units, both T<sub>1</sub> and T<sub>2</sub>, may be purchased if the constructor wishes to save time and labor. They are priced at about \$6.00 each.

#### THE VACUUM TUBE STRIP

THE vacuum tube socket is "spun" into a sub-panel  $3\frac{1}{2}'' \times 5'' \times \frac{3}{16}''$  on which are located the filament resistance mounting clips, binding posts, audio-frequency transformer and mounting bracket, but single sockets made for

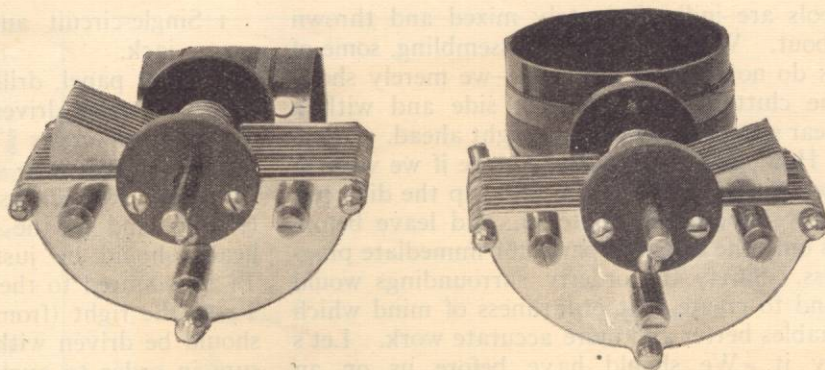

FIG. 5  
The tuning units T<sub>2</sub> and T<sub>1</sub> (left to right)

panel mounting may be purchased for about \$1.50 and the assembly of the sub-panel will then be up to the ingenuity of the constructor himself. Figs. 10, 11, and 12 will help to show the proper arrangement of parts.

In assembling, care should be taken that the audio-frequency transformer is placed with its grid terminal adjacent to T<sub>1</sub>; the plate terminal will then be close to T<sub>2</sub> so all leads may be made very short.

Four binding posts are located on this sub-panel as indicated in the drawing Fig. 8. This is the correct method in contrast to the photographs which show a receiver with a slightly different wiring system.

Special attention should be given the springs of the tube socket as "dead" tension will in time cause a great deal of difficulty, chiefly characterized by noisy and spasmodic operation.

#### THE FRONT PANEL

THIS should be of Bakelite, Formica, or Radion, 9" long,  $7\frac{1}{2}''$  high and  $\frac{3}{16}''$  to  $\frac{1}{4}''$  thick. Bakelite or Formica should be sanded or grained on both sides, but Radion should retain its original finish. The panel is drilled in accordance with the front panel layout, Fig. 7, but the position of holes may be changed to suit any condensers.

#### ASSEMBLY

AT ABOUT this stage in the manufacture of a home made receiver, the amateur workshop, whether it be a real shop, the kitchen, parlor, or attic, has assumed an air of congested indecisiveness that hardly bespeaks the usually tidy habits of the constructor; coils, tools, condensers, dirt, sockets, wire, binding posts, solder, and some more dirt and



tools are indiscriminately mixed and thrown about. When it comes to assembling, some of us do not stop to clean up—we merely shove the cluttered mass to one side and with a clear space of six inches go right ahead.

How much better it would be if we were to stop for a few moments, clear up the dirt, put away unnecessary material, and leave before us only the essential parts for immediate progress. Surely the orderly surroundings would tend to create that orderliness of mind which enables better and more accurate work. Let's try it. We should have before us on an otherwise clear table the following parts:

- 1 T<sub>2</sub> transformer unit.
- 1 T<sub>1</sub> transformer unit.
- 1 Sub-panel with binding posts, tube socket, A. F. transformer, and resistance mounting clip in place.
- 1 Crystal detector.

1 Single-circuit automatic filament-control jack.

1 Front panel, drilled and sanded.

Also a screw driver and 3  $\frac{8}{32}$  flat-head machine screws  $\frac{3}{8}$ " long.

The vacuum tube strip is mounted first by threading two screws into the angle bracket (Fig. 9, and at the right in Fig. 10). The heads should be just flush with the panel. T<sub>1</sub> is mounted to the left of the socket strip, T<sub>2</sub> to the right (from the front). All screws should be driven with a firm and equal pressure in order to avoid unnecessary strain on the condenser shafts.

The aerial binding post is placed in the upper left-hand corner of the panel—this is arranged so connection is made from the rear, obviating an unsightly lead-in. The crystal detector and jack are mounted last; the frame of the jack should be facing down. As the final step

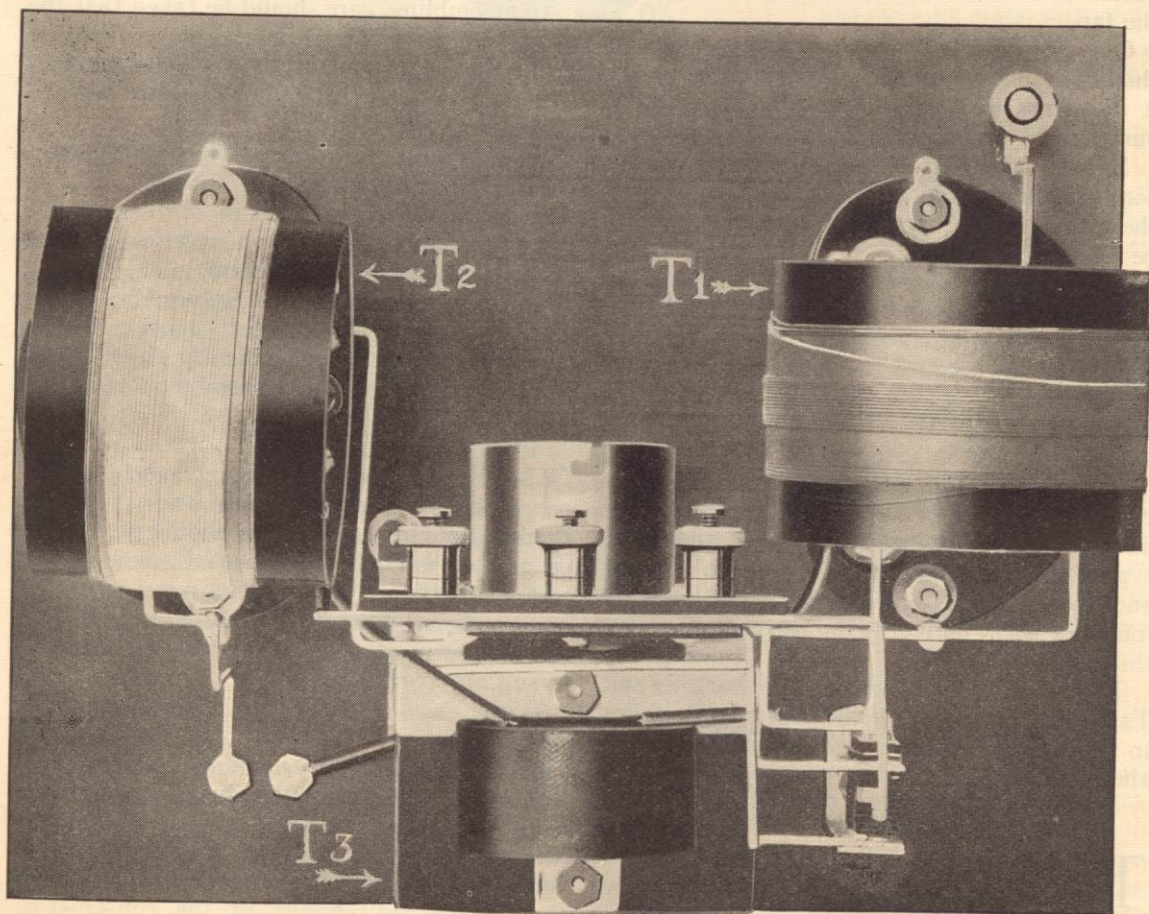

FIG. 6

The receiver as seen from the rear



in assembling, the dials are placed upon the condenser shafts and so arranged that the movable plates are all "in" when the indicating mark on the panel is in line with the highest mark on the dial.

NOTES ON WIRING

**A**GAIN there is need for a clear space, the proper tools, and, if possible, some experience. As every joint must be soldered, a soldering iron is quite essential. So also is a pair of  $\frac{1}{4}$ " flat nose pliers, a clean rag and bus bar wire. "50-50" bar solder is splendid, and soldering paste may be used if difficulty is experienced with rosin flux, though the excess should be removed with a little alcohol, after the soldering is completed.

Although each of us has his own way of doing things, the generally acknowledged method of wiring may be condensed in the following seven points:

- 1—Solder all joints. Soldering to a lug and screwing the lug to a terminal does not constitute a solder joint—the wire should be soldered direct to the terminal.
- 2—Flow the solder in all joints so they are perfectly smooth when cold. This requires a properly heated and tinned iron with sufficient flux.
- 3—Do not be too sparing in the use of flux, but immediately after soldering remove all traces of paste—with scrupulous care.
- 4—Use square tinned bus bar wire whenever possible.
- 5—Make 90° bends and run stiff connections only vertically and horizontally.
- 6—Wires more than a few inches in length should be run against the panel or other insulating support—they should not be left unprotected in space.
- 7—When soldering a wire to a terminal, aim the wire toward the center of the terminal—do not solder it to the side.

Wire the filament circuit first; the positive A

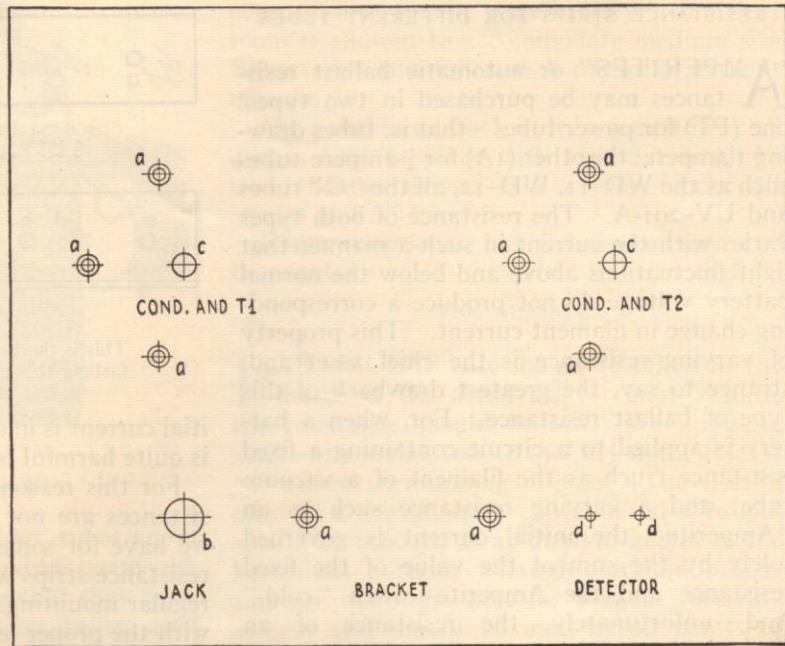

FIG. 7

This plan is  $\frac{4}{5}$  the actual size of the panel. For *a* holes, use No. 27 drill and countersink the holes to fit flat-head screws; for *b*, use No. 27 drill; for *c*, use  $\frac{5}{16}$ " drill; for *d*, use  $\frac{9}{16}$ " drill

battery terminal runs direct to one filament contact while the negative A battery terminal goes through the automatic filament control jack break and the "Amperite" mounting (R1) to the other filament contact, thus completing this circuit.

The transformers are connected as follows:

T1—No. 1 to the aerial binding post; No. 2 to the negative A battery terminal; No. 3 to the stationary plates of the variable condenser and then to the grid spring of the tube socket; No. 4 to the rotary plates of the variable condenser and to the "G" terminal of the secondary of the audio-frequency transformer, T3.

T2—No. 1 to the plate contact of the tube socket; No. 2 to the positive B battery binding post. No. 3 to the stationary plates of its variable condenser and to either terminal of the crystal detector; No. 4 to the positive B terminal of the primary of T3 and the rotary plates of the condenser.

T3—"F" to negative A battery terminal; P to the other side of crystal detector. Connecting the negative B battery binding post to the long curved spring of the jack completes the circuit and the receiver is finished!



RESISTANCE STRIPS FOR DIFFERENT TUBES

"AMPERITES" or automatic ballast resistances may be purchased in two types; one (PT) for power tubes—that is, tubes drawing 1 ampere; the other (1A) for  $\frac{1}{4}$ -ampere tubes such as the WD-11, WD-12, all the "C" tubes and UV-201-A. The resistance of both types varies with the current in such a manner that light fluctuations above and below the normal battery voltage do not produce a corresponding change in filament current. This property of varying resistance is the chief asset and, strange to say, the greatest drawback of this type of ballast resistance. For, when a battery is applied to a circuit containing a fixed resistance (such as the filament of a vacuum tube) and a varying resistance such as an "Amperite" the initial current is governed solely by the sum of the value of the fixed resistance and the Amperite—when "cold." And, unfortunately, the resistance of an Amperite is much lower when "cold" than when heated by passage of current—therefore the in-

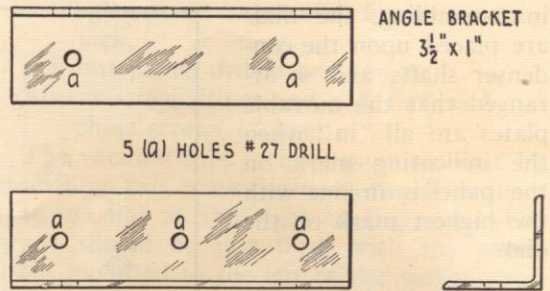

FIG. 9

This is the bracket (half actual size) that fastens the sub-panel to the main panel

itial current is in excess of the proper value and is quite harmful to the filament of a tube.

For this reason and also because ballast resistances are not made for all types of tubes, we have for some time been using fixed wire resistance strips which may be slipped into the regular mounting. They are easily made, and with the proper length and size wire may have any value of resistance.

The first few were made from portions of the resistance element of a regular 6-ohm rheostat. Each portion was 2" in length and utilized the resistance wire salvaged from the rheostats.

A much neater job can be made however if  $\frac{3}{8}$ " insulating rod cut into 2" strips is fitted with two metal end pieces and wound with the resistance wire, both ends of which are soldered to the end pieces. The rod should be threaded so the wire will not slip and short circuit adjacent turns. Small thumb tacks or similar devices have been employed as connecting end terminals.

It is necessary to know or determine the resistance per unit length of wire in order that the proper amount may be employed to offer the correct resistance.

Having selected a type of tube and the A battery voltage, reference to the table will enable selection of the proper resistance strip. Thus, if a UV-199 with 4.5 volts "A" are chosen, a strip of 30 ohms should be inserted in the sub-panel clips; a WD-11, WD-12, or W. E. "N" tube with a single dry cell will require a 2-ohm resistance, and so on.

Choice of tubes and batteries rests with the constructor; personally we prefer a UV-201-A with 4 series dry cells or a 6-volt storage battery. However, the UV-199 with 3 series dry cells very nearly equals the UV-201-A and is much more practical for dry cell operation. The

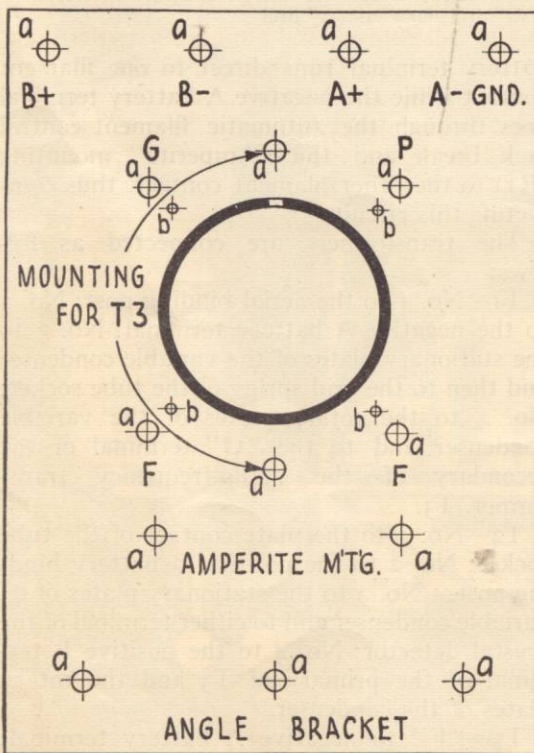

FIG. 8

Plan for the sub-panel. This is in correct proportion, but less than actual size ( $\frac{1}{4}$ ). For a holes, use No. 27 drill; for b holes, use No. 52 drill



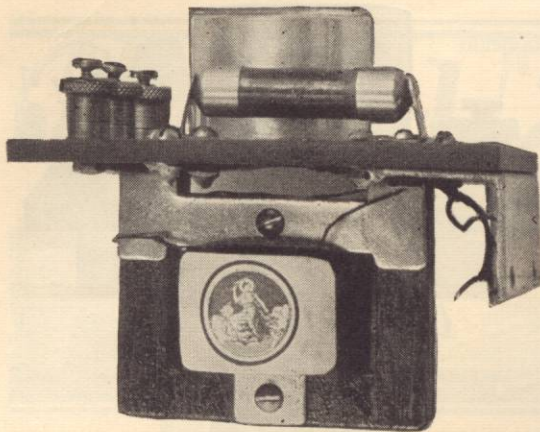

FIG. 10  
The sub-base from the left

WD-11, WD-12, and W.E. "N" tubes are of the single dry cell type; they operate quite well, but it has been our experience that they come through very irregularly—some being good and others quite the opposite. The B battery voltage may vary from 45 to 90 although with this receiver as much as 300 volts has been applied to the plate of a UV-201-A; the resultant volume being comparable to the output of a single-tube super-regenerative receiver.

The following table shows the value of resistance for use with different A battery potentials on various tubes in order to restrict the current to a point slightly below the normal consumption rate.

TUBE	BATT. VOLTAGE	RESISTANCE	CURRENT
	(Representing 1, 2 and 3 storage cells and 1, 2, 3, and 4 dry cells.)		
UV-201-A	6.0	6.0	.23
UV-201-A	4.5	0.*	.22
UV-201-A	4.0	0.*	.20
WD-12	1.5	2.0	.23
WD-12 } or-11	2.0	4.1	.23
UV-199	3.0	0.*	.06
UV-199	4.0	18.0	.06
UV-199	4.5	30.0	.06
UV-199	6.0	55.0	.06
UV-20*	6.0	1.5	.92

THE CABINET

THIS may be readily constructed at home if one is at all handy with wood working tools. Otherwise, it should be purchased.

The left-hand battery compartment is for the filament heating source, and the right-hand

\*Direct short. May be made like other resistance strips but has only a copper wire joining the end terminals.

compartment for the plate battery. Sufficient room is allowed to accommodate medium size B batteries and full size A dry cells without crowding.

The panel is set back in its compartment 2'' and is held in place with four flat head  $\frac{3}{4}$ '' wood screws driven into corner blocks  $\frac{3}{4}$ '' square and 2'' long.

Finish is optional, but a dull gloss seems to be popular.

THE AERIAL

PARTICULAR care should be taken in the design of the aerial as, for best results, the resistance should be low. We advise a single-wire aerial, 100' to 150' in length, at least 20' above surrounding objects. The lead-in may be a continuation of the aerial wire and should be brought away at right angles to the horizontal portion. Glazed porcelain insulators are doubtless best for a small receiving system and should be used at all points of suspension.

In the event that an aerial cannot conveniently be employed, reception may be effected with a ground connection alone. This usually will give equal if not better results than a small aerial. The ground should be connected to the aerial terminal and the receiver tuned in the usual manner. Several grounds should be tried—the best type appears to be

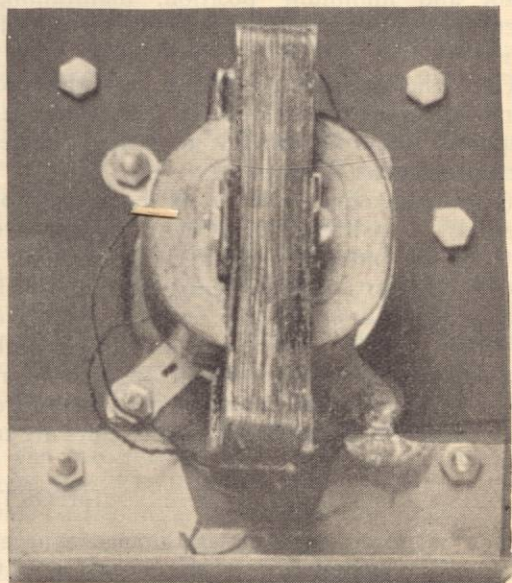

FIG. 11  
The sub-base from below



one in which a rather long lead runs to a distant ground; this is, in effect, a grounded aerial with the receiver connected to the free end. The lighting system may be employed in a similar manner through use of an "antenna attachment"—if results are satisfactory the more or less cumbersome aerial may be dispensed with.

#### INSTALLATION

(A) Connect both A and B batteries to their respective binding posts—care being taken to have the polarity correct. Use number 18 or heavier rubber-covered stranded wire and keep all leads short and direct.

(B) Insert the vacuum tube and Amperite in their sockets and ascertain that positive contact is assured; it would be well to bend up the socket springs slightly in order that they may exert considerable force upon the vacuum tube pins.

(C) Connect a suitable ground to the negative A binding post and an aerial such as described above to the aerial binding post.

#### OPERATION

(A) Place the output plug in the jack; the vacuum tube should light instantly.

(B) Set both dials to the same point and adjust the crystal detector until a fairly strong "click" is heard.

(C) Slowly vary both dials between maximum and minimum position, maintaining them in approximately equal relation to each other.

(D) When a station is heard, turn the grid variable condenser and center it for stronger response, following this by adjusting the detector for better results.

(E) Further manipulation of the crystal for the most "sensitive" adjustment will improve both the quantity and quality of reception.

(F) With an average antenna, both dials will nearly coincide for any wavelength. No difficulty will be experienced in tuning both circuits to the same resonant frequency, as clicks (from crystal adjustment) are heard only when the grid and detector circuits are in

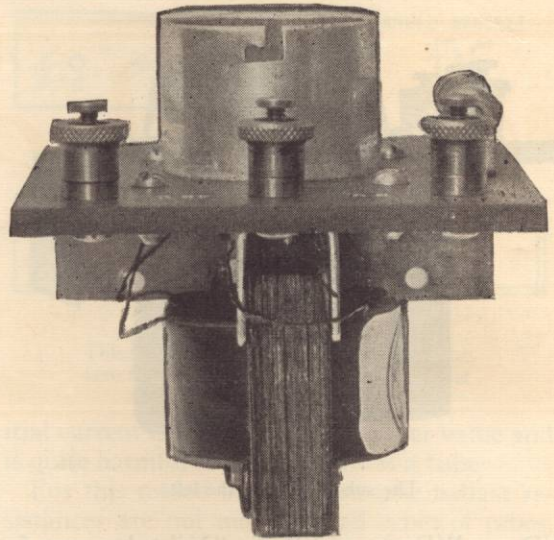

FIG. 12  
The sub-base from the rear

tune with each other; being loudest when the circuits are exactly in resonance.

(G) When the crystal contact is "off," the receiver may oscillate, especially if headphones are used while tuning. There are a few methods of stopping this, but as it is rarely annoying special precautions are not necessary.

(H) On strong signals, the condenser in the crystal detector circuit is not very critical, but it has a well defined maximum resonant peak which may be passed over if this control is varied too rapidly.

(I) It is the combination of controls that makes for selectivity, and both are quite critical on weak stations.

(J) The crystal adjustment is important not only for strength and clarity of signals but also for selectivity.

(K) On a stiff piece of manila paper provide three columns to record:

(1) Stations call letters, (2) T<sub>1</sub> dial settings and (3) T<sub>2</sub> dial settings. This record may be permanently placed on the inside of the cover (under transparent celluloid, for example) and referred to when the program of a certain station is to be tuned in.

#### IMPORTANT NOTICE

For the broadcasting wavelength range we have found that variable condensers from .00029 to .0004 are preferable to .0005, but if you already have .0005 they will do very well. The coils described as T<sub>1</sub> and T<sub>2</sub> may be made by securing two 60-turn duolateral or honeycomb coils and winding the necessary number of turns for the primaries right on the outside edge. Arrangements have been made with several manufacturers to supply any of the parts by mail, if your local dealer cannot supply you.—THE EDITOR.



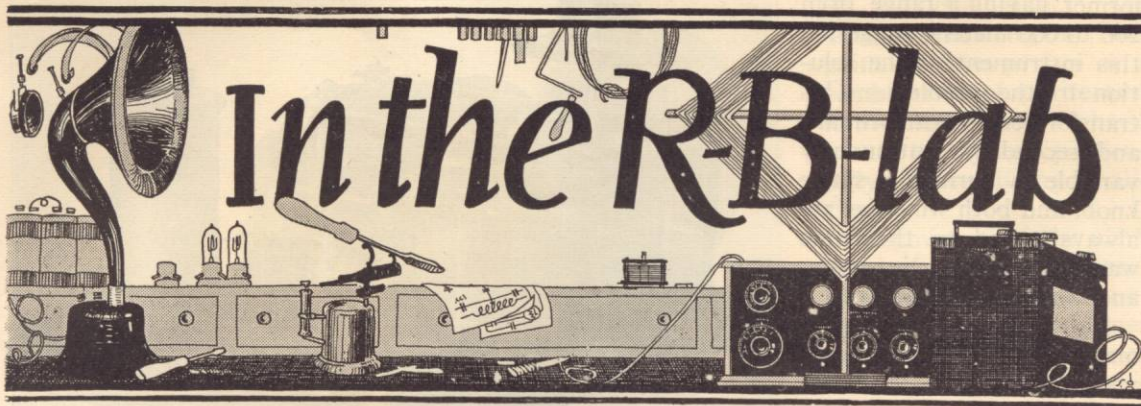

So much corking good Lab material is piling up that we are forced to devote more space to it this month than we originally intended it to occupy. Our successful experiments with the apparatus described, and the many letters of inquiry, appreciation, and suggestions that have come to our office since the R. B. Lab was started, in October, persuade us that we could not employ these pages to better advantage.

Upon observing the one-tube reflex circuit in operation and seeing a sample of a Ballantine Variotransformer sent us for test, Mr. Zeh Bouck, Editor of the R. B. Lab, suggested the unique arrangement he describes below. We then asked the manufacturers of the transformer to build up a circuit in the manner described. A comprehensive report from that company indicates that the results obtained check with our own, and that the Variotransformer works about as well in the circuit as the radio-frequency transformer and variable condenser combination described in R. B. for November and used by Mr. Bouck.

RADIO BROADCAST will be pleased to buy from its readers, at prices from three to five dollars, commensurate with the value of the data, kinks, devices, original ideas, etc., with photographs if possible, which the editor may consider eligible for this department.—THE EDITOR

## IMPROVING THE ONE-TUBE REFLEX SET

THE article by Mr. Kenneth Harkness, in the November RADIO BROADCAST, on the best one-tube reflex set that has ever been brought to the attention of this magazine, furnished the Lab with material for additional experiments. The object of the tests was the elimination of the predominant and admitted defect of such sets, namely the tendency toward self-oscillation. This fault was overcome to a considerable extent in Mr. Harkness' set, and though remarkably stable for apparatus of this type, the set will nevertheless oscillate at certain adjustments on the radio-frequency transformer (T<sub>2</sub>, page 14, RADIO BROADCAST for November). These adjustments are: (1) when the single tuning condenser across the secondary of the transformer does not effect sufficient resonance between the primary and secondary (when they are not tuned sufficiently near to the same wave), and (2) when a high-resistance contact is made by the cat-whisker on the crystal detector, an adjustment, incidentally, which is often the most sensitive one.

The reason for oscillations at such adjustments is this: If a circuit has a tendency to oscillate, such as is a characteristic of the plate circuit of the bulb in the one-tube reflex, and another resonant circuit is coupled to it, so much energy will be absorbed by this second circuit that not enough will remain to sustain oscillations. But of course the moment that this second circuit is detuned (or imperfect resonance is established, as often happens with the single tuning condenser), or the circuit is opened (as is virtually the case when the resistance of the crystal detector contact, which is in series with this additional circuit, is raised very high), oscillations will start.

However, these difficulties would be obviated if the transformer unit could be so arranged that there would always be so perfect a resonance between the primary and secondary windings, that even with a high-resistance crystal contact, sufficient energy would be absorbed to smother oscillations. The development of the Ballantine Variotransformer, which is a tunable radio-frequency amplifying trans-



former having a range from 200 to 600 meters, suggested this instrument as the solution to the problem. This transformer has both primary and secondary continuously variable by turning a single knob, and both windings are always tuned to the same wavelength, i. e., in resonance with each other!

Fig. 1 shows the set as made up under the supervision of the R. B. Lab and in which our theory was maintained beautifully in practice. The circuit is identical with that shown on page 14 of the November RADIO BROADCAST, except that the Ballantine Variotransformer is substituted for T<sub>2</sub>, and, of course, the variable condenser across the secondary of T<sub>2</sub> is not used.

#### WHAT THIS SET WILL DO

**O**N THE single tube shown in the photograph and on the diagram, it will bring in signals more loudly and clearly than a one-tube, single-circuit regenerative set. Reception is generally superior to that achieved with the set described by Mr. Harkness in the November RADIO BROADCAST.

With one exterior stage of audio amplification, it will bring in local broadcasts so as to fill a large room (the single tube itself will actuate a good loud-speaker) giving a volume exceeding that of the average regenerative set with two stages of audio amplification.

It gives signals of remarkable clarity, with freedom from crackling sounds (excepting static, of course) and other extraneous sounds.

It will tune sharply with a minimum of effort, and with greater ease than any single-circuit regenerator.

#### WHAT THIS SET HAS DONE

(The following four paragraphs, by the Editor of this magazine, indicate what he, personally, has done with the receiver under discussion.)

**W**E HAVE tried this one-tube reflex with all kinds of tubes in all kinds of places. In every case it has proven to be a "knock-out." On Long Island, 23 miles from New York, we have heard two stations in Chicago on a loud-speaker, using a 60-foot antenna and a single UV-199 tube with about 80 volts on the plate. The music was not loud enough to dance to or keep the neighbors awake, but it could be heard in a room of moderate size. Speech was perfectly understandable, and several of our friends who witnessed the performance were as amazed as

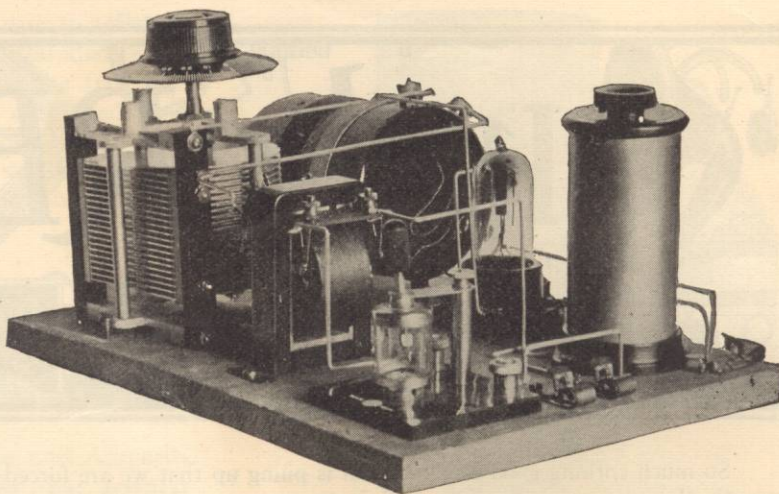

FIG. 1

Showing the one-tube reflex circuit made up by the R. B. Lab. The Ballantine Variotransformer is used.

we were. Truly, we did not expect such results. To date, we have heard (from Garden City, L. I.) KDKA, WGY, WJAZ, and WDAP on a loud-speaker, with the equipment described above, which is not too bad. The local stations can be heard on a loud-speaker either night or day and many other long-distance stations have been heard on the phones.

During the radio show in New York, some of our out-of-town friends were anything but polite in letting us know that our enthusiastic statements regarding this one-tube reflex were taken with a grain of salt. One went so far as to say, "Radio and golf will surely make liars of us all." That was the last straw. We took a train for Long Island, grabbed our little set from the living room table, amid shouts of objection from an erstwhile happy family, and returned to New York. We made directly for the room of our friend, our pockets jammed with dry cells, B batteries, a pair of phones, and a coil of annunciator wire. Under one arm we carried the receiver; under the other a loud speaker.

In a few minutes all the connections were made. A cuspidor-weighted wire swung from a window on the twenty-first floor of an exclusive New York hotel. We were less than two blocks (or squares) from the powerful broadcasting station of the Radio Corporation at Aeolian Hall. We had no trouble in tuning out that station and bringing in other New York stations on the loud speaker—which does not speak badly for the selectivity of the receiver!

#### WHAT THIS SET WILL NOT DO

**T**HE set will not oscillate, or "spill over," to your own annoyance and that of your neighboring enthusiasts (except as described above).

It is apparently immune to body capacity effects, shielding being quite unnecessary.





FIG. 2

The one-tube reflex described below. It will operate a loud speaker on local stations

For a description of the parts, other than the Variotransformer, and for constructional data, the reader is referred to the November issue of RADIO BROADCAST. This set can be mounted on a panel, the Variotransformer being made in panel-mounting style.

#### THE ONE-TUBE REFLEX WITH A BALLANTINE VARIOTRANSFORMER

(Report by Dr. L. M. HULL of experiments conducted by him at Radio Frequency Laboratories, Inc., Boonton, N. J.)

THE circuit described in the article "A Single-Tube Reflex Receiver" has been assembled and tested, using as the radio-frequency transformer,  $T_2$ , a Ballantine Variotransformer, Model 5. Transformer T (refer to Fig. 1 in the above designated article) was constructed for our test circuit according to the specifications supplied by the writer. The transformer,  $T_3$ , was a General Radio "Amplifying Transformer" having a turn ratio of approximately 4:1. A type UV-201-A tube was used, with approximately 80 volts on the plate.

As a crystal detector we used alternatively an iron point on iron pyrites or a combination of pyrite and ferro-silicon which we have found to possess particularly fine rectifying qualities.

Assuming that the main point of interest is the performance of the circuit containing a Variotransformer relative to its performance with the transformer specified in the article, a second tuned transformer was constructed according to the specifications supplied for  $T_2$ , and for purposes of comparison this transformer (which will hereafter be designated the " $T_2$  coupler") was substituted for the Ballantine Variotransformer at given adjustments of the crystal detector. For the reception of signals an antenna and counterpoise were connected between terminals A and G hav-

ing in combination an effective capacity of 700-500 micro-microfarads between 300 and 600 meters and an effective resistance varying from 13 to 16 ohms in this wavelength range.

When this circuit was excited by a locally generated modulated radio-frequency E.M.F., the Ballantine Variotransformer produced an appreciably greater amplification than the  $T_2$  coupler at wavelengths between 300 and 400 meters, indicated by a louder signal in a head set connected between the jack terminals (see Fig. 1, page 218) as well as by the production of an audible sound with the Variotransformer from a signal so weak as to be inaudible with the  $T_2$  coupler: there was no appreciable difference in selectivity in this range. Between 400 and 500 meters the signal intensity appeared to be very closely the same with either radio-frequency transformer. It was possible, by selecting a high-resistance contact on the crystal to force regeneration to the point of strong sustained oscillation with the  $T_2$  coupler, thereby increasing the sharpness of tuning above that obtainable with the Variotransformer. The circuit containing the Variotransformer was by far the more stable of the two, since it was found to be impossible to throw the circuit into oscillation with any adjustment of the crystal and



any tuning combination. At wavelengths above 500 meters there was no apparent difference between the behavior of the two circuits, although in subsequent tests signals from spark transmitters on 600 meters were received with appreciably greater intensity when using the Variotransformer.

In comparative reception tests, telephone signals were received from the New York stations (distances from 30 to 35 miles), from Chicago, Schenectady, and Buffalo. At the lower wavelengths, transmitted by WHN and WGY, signals were received with slightly greater intensity when using the Variotransformer.

At wavelengths above 400 meters there appeared to be little choice between the two transformers, as regards intensity and quality of the sounds produced.

One difference between the behavior of the two circuits was noticed, however, in that the tendency of the circuit toward self-oscillation when using the  $T_2$  coupler depended largely upon the nature and location of the detector contact, whereas no oscillations whatever were produced when using the Variotransformer. Thus with the Variotransformer

### SELECTIVITY

When your receiver is to be located within less than ten miles of a broadcasting station and you desire to cut that station out and bring in those a long distance off, even though they may be on nearly the same wavelength as the local station, the tuning system described at the bottom of page 6 is better than the vario-transformer arrangement. Then, too, the receiver described on page 24 is much more selective. However, the single tube and crystal circuit is sharp enough for use any place more than ten miles from a broadcasting station, as you may see if you turn to page 43.

the tuning adjustment was entirely independent of the adjustment of the detector for sensitivity, and this stability and relative ease of operation were not offset by any appreciable decrease in the relative signal strength.

No quantitative measurements were made of the signal intensity obtained with the Variotransformer in this circuit. The programs broadcasted by stations WEA and WJZ on the night of October 12th were received on this circuit and reproduced with good intensity in a high-impedance loud speaker.

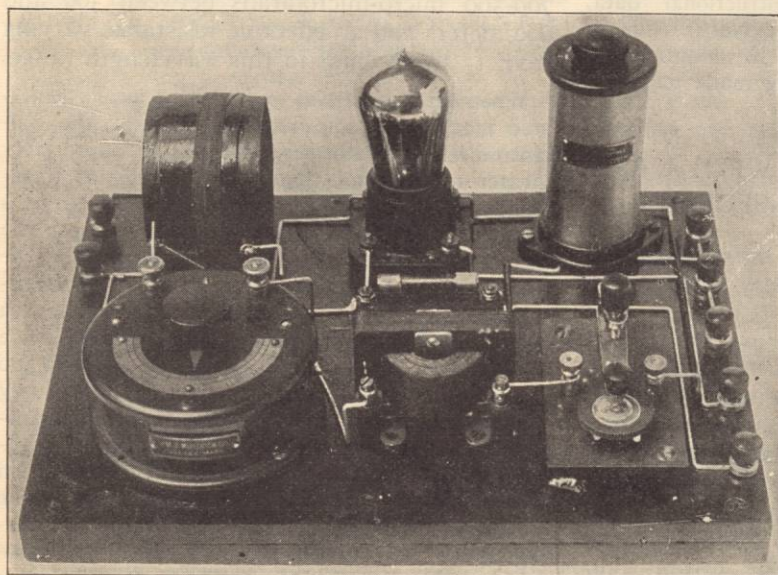

FIG. 3

The set made by Radio Frequency Laboratories, Inc., showing the primary of the antenna coupling wound over the secondary. In the R. B. Lab's model the two windings are laid on side by side

### USING A COUNTERPOISE

A counterpoise is a very effective method of improving the selectivity of any receiver employing an outside aerial. In its most practical form it is a single wire stretched in the same manner as the regular aerial but nearer the ground. Ten feet is a good height. It may be from 50 to 150 feet long. When a counterpoise is used the regular ground connection is not used.



# The Grid

## QUESTIONS AND ANSWERS

### ADDING ONE AUDIO REQUIRES NO JUNKING OF PARTS USED IN THE ONE-TUBE REFLEX CIRCUIT

The circuit illustrated and described here has been built and operated successfully by many of our readers. Either of the two previously described systems may be converted into this one. The result is more volume.

#### ADDING AUDIO AMPLIFICATION TO THE R. B. ONE-TUBE REFLEX

*I have built the one-tube reflex set described in the November RADIO BROADCAST, and I must say it is a wonderful little set. I should like to add one stage of additional audio amplification to it, and should appreciate your showing me just how it is done. I should like to use filament control jacks, as one of this type is already in the single tube set.*

R. O. O., New York City.

**T**HE accompanying diagram Fig. 1 shows the connections for adding one stage of exterior, or straight audio-frequency amplification to the single-tube reflex set. Filament control jacks, of the most easily obtainable type, have been indicated, but readers not possessing jacks of this design may use any other type that will accomplish the same thing. The reader having any doubt concerning

the connections for the particular type of jack which he finds it necessary to employ, is advised to read the article on "Jacks and How to Use Them" appearing in the April RADIO BROADCAST. Of course, straight double-circuit non-filament-control jacks may be used if desired, the filaments being turned off by a switch, if a balance resistance such as the "Amperite" is used, or by a rheostat, which acts as a switch when in the "off" position.

Observant readers may notice that the positions of the telephone receivers and the "B" battery have been reversed. The reason for this is explained in the amplification article in the July RADIO BROADCAST, which readers desiring to add amplification to any set, will find it worth while reading. The diagram is otherwise quite self-explanatory. Any well known and reliable amplifying transformer can be used. This one additional stage will probably be all that will ever be desired on this remarkable little set.

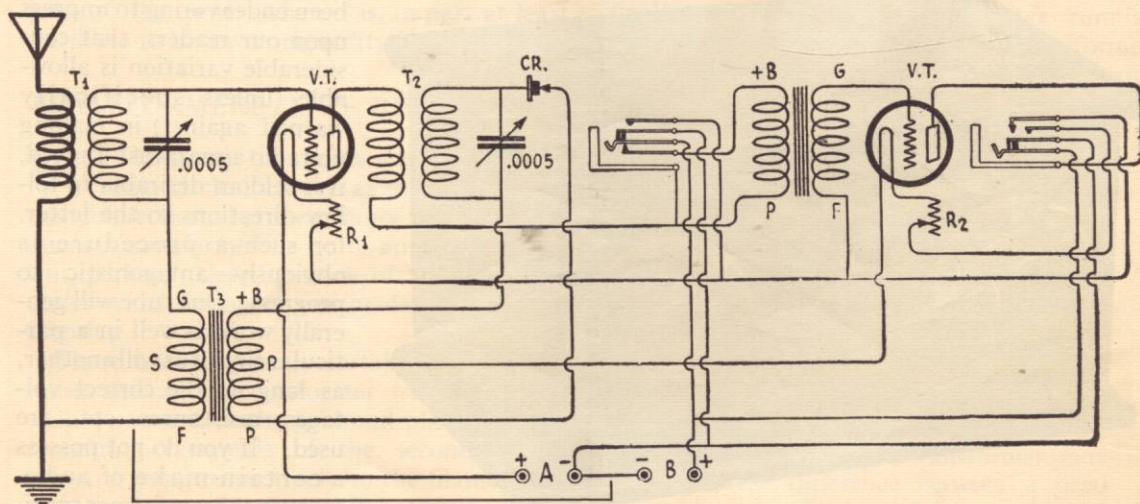

FIG. 1

One stage of audio added to the one-tube reflex set. Note the position of telephones and "B" batteries



### THIS CLEVER SCHEME EVOLVED BY MR. C. H. BROWN

Is one of several possible methods of providing the inductances where the  $2\frac{5}{8}$ " tubing specified in the preceding articles is difficult to procure. Another satisfactory method is the use of two 60-turn honeycomb, duo-lateral or Remler coils for the secondaries of T<sub>1</sub> and T<sub>2</sub>. The primaries are then wound on the outside edge of the secondaries. The primaries should be wound *in the same direction* as the secondaries.

### SPIDER WEBS AND THE ONE-TUBE REFLEX

THE photographs in Figs. 6 and 7 show a single-tube reflex set made after the complete instructions given in the November, 1923, issue of RADIO BROADCAST. The apparatus was constructed by Mr. C. H. Brown, and we are sure our readers will agree with this department that he made an excellent job of it.

Mr. Brown, however, departed slightly from

the plans worked out by Mr. Kenneth Harkness, substituting spiderweb coils for the conventional layer windings in the original apparatus. It is likely that the spider-web inductances are slightly more efficient. No. 28 enameled wire was used, all windings being made with the same number of turns as specified in the November article, which any one considering such a set is advised to read. The primaries are also wound over the secondaries.  $3\frac{1}{2}$ -inch to 4-inch winding forms made from pasteboard, thin wood, or fibre are about the correct size; the winding starts  $\frac{3}{4}$ -inch from the center. Any odd number of segments or slits in the spiderweb forms may be used. Between ten and thirty are the most common and convenient.

Mr. Brown has also replaced the fixed resistance with a standard filament rheostat, a change of which this department approves. The rheostat is connected in the identical position of the fixed resistance.

The crystal detector used in Mr. Harkness' set has not, at this writing, been placed on the American market, but the builder of this neat set found an efficient substitute. Any good crystal detector may be used in place of the French arrangement mentioned in the original write-up. A permanent crystal is now on the market, which needs no adjustment, and so reduces by one the controls that must be manipulated.

The set illustrated in Figs. 6 and 7 is particularly interesting because of these deviations from the original described in the November issue. It is an excellent example of what we have been endeavoring to impress upon our readers, that considerable variation is allowable (unless specifically warned against) in making up radio apparatus. Indeed, it is seldom desirable to follow directions to the letter, for such a procedure is obviously antagonistic to progress. One tube will generally work as well in a particular circuit as will another, as long as the correct voltages, resistances, etc., are used. If you do not possess a certain make of audio-frequency transformer specified by one builder, use what



FIG. 6  
Mr. Brown's neat reflex



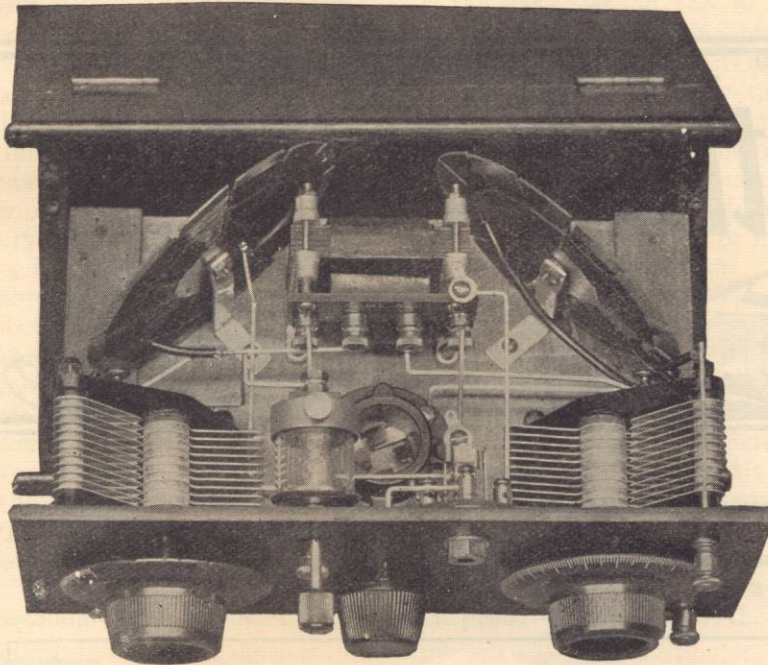

FIG. 7

The "works" of Mr. Brown's one tube reflex set. Note the spider-web coils

you have or can obtain, always, of course, confining yourself to good apparatus. Mr. Brown uses an Acme transformer; this laboratory has used the Amertran and Pacent with equally good results. If a set calls for a straight coil of wire, but you have (or prefer) a honeycomb, bank-winding, or spider-web, use it. The chances are it will work as well as, or even better than the inductance specified.

A radio set is of infinitely more value and pride to the owner, when it is, in part at least, a tribute to his own originality and thought.

#### TRANSFORMERS AND REFLEX SETS

WITH the stir that reflex sets are making in radio circles, a word as to the proper series connections between radio- and audio-frequency transformers is quite appropriate, and will, perhaps, clear up some of the difficulties under which many of our readers seem to be laboring.

There are, of course, certain ends of both radio and audio transformer windings which should connect to the grid and plate, with the remaining terminals of the secondary and primary going respectively to the filament and plus (positive) side of the B battery. In the majority of cases, these terminals will be found

marked as "G," "F," "P" and the plus sign, +, or in another equally obvious manner. However, in a few cases, the reader may be left in doubt. In the case of a single-layer primary and single-layer secondary radio transformer, such as is found in the neutrodyne circuit, the coils are always wound in the same direction. Then if the start of the primary is led to the plate, the start of the secondary must run to the grid. In the case of audio transformers, the outside leads from primary and secondary run to the plate and grid respectively. It is generally a simple matter to determine the outside leads by noting how far from the core they enter the windings.

In reflex sets the *grid* terminals and the *plate* terminals must always run to those two elements of the tube, either directly or through the windings of another transformer. The windings must always be "pointed" or heading in the right direction. For instance, the grid connection from an R. F. transformer will go to the grid, as it should, while the filament end of the secondary winding will run to the *grid connection of the audio transformer*. Thus the filament connection of the R. F. transformer finally reaches the filament, after running through the secondary of the audio transformer, while the grid connection of this latter transformer reaches the grid by running through the secondary of the radio transformer.

#### HOW TO CONNECT WHICH END OF A TRANSFORMER TO WHAT

The successful operation of reflex receivers depends to a great extent upon the direction in which the current passes through the various circuits. The explanation given above tells you the reason a simple reversal of the leads from a single transformer may mean the difference between a dead and a very live receiver.



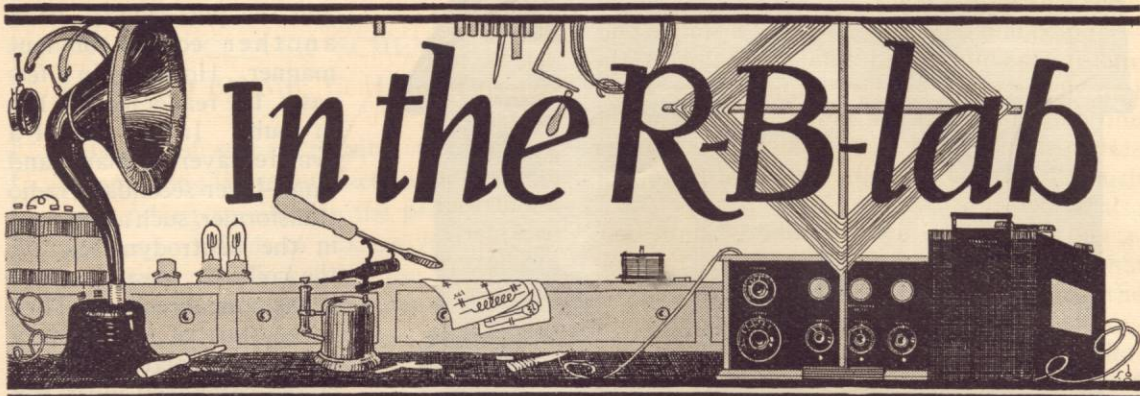

The "lab" department has been inaugurated by RADIO BROADCAST in order that its readers may benefit from the many experiments which are necessarily carried on by the makers of this magazine in their endeavor to publish only "fact articles" backed by their personal observations.

#### LOOK BEFORE YOU LEAP

We have carried on a lot of experimental work with the Sodion tube. The article describing one use for it, published here is based upon this experimental work. At present, the number of Sodion tubes available is limited and before beginning the construction of this receiver we suggest that our readers be certain of their Sodion tube supply.

## THE SODION TUBE AND OUR "KNOCK-OUT" REFLEX

**N**O CIRCUIT ever published by RADIO BROADCAST has aroused such interest among its readers as the one-tube reflex set originally described in the November number. Stimulated by suggestions from the hundreds of readers who have written to us concerning this circuit, and by our own enthusiasm for this remarkable little set, this department has not given it up as devoid of further improvement and research. The use of the Ballantine Varioformer, in place of the home-wound T<sub>2</sub>, described in the January Lab, and the reflex plus two stages of audio amplification, in our February number, are the result of our continued investigation. And now we have some more good news.

#### DETECTION AND REFLEX CIRCUITS

**T**HE problem of detection in reflex circuits is one of the most serious involved in the design of such apparatus. As we have had occasion to state before, the three-element vacuum tube with its oscillating proclivities, complicates a reflex circuit to such an extent as to render this form of detection undesirable. This has left the crystal as the most satisfactory detecting medium, and the one which has been used, almost altogether, in commercial types of reflex apparatus.

The Sodion tube, however, being a stable and non-oscillating detector, will immediately suggest itself to the reflex experimenter as a detector. The R. B. Lab experienced little



difficulty in adapting this new tube to the erst-while single-tube reflex.

The Sodion detecting circuit is a simple one, and it was illustrated fundamentally in the Lab department for last month. The input and output circuits are similar to those of the standard tube, and Fig. 1 shows the manner in which the Sodion bulb is substituted for the crystal detector.

The output of the R.F. tube is impressed, through the transformer T<sub>2</sub>, on to the collector circuit (C), (analogous to a grid circuit in a regular tube), of the Sodion tube. The output of the Sodion tube, like that of the usual audion, is a varying plate current, and this is sent through the primary of the reflex audio transformer. The final amplified output, through the telephone receivers, is taken, as usual, from the plate circuit of the first and conventional bulb.

T<sub>1</sub> and T<sub>2</sub> are wound on 2½ inch tubes, the secondaries being wound first, with the primar-

ies on top of them, an insulating layer of paper being placed between. The secondary of T<sub>1</sub> consists of sixty turns of wire, and that of T<sub>2</sub>, of forty turns. The primary of T<sub>1</sub> has sixteen turns, and that of T<sub>2</sub> thirty-six turns. C<sub>1</sub> is a 17-plate variable condenser, and C<sub>2</sub> a 43-plate condenser. T<sub>3</sub> is any good make of audio amplifying transformer with a ratio of about four or five to one—such as the Pacent or Amertran.

The critical reader will observe that the specifications for T<sub>2</sub> and C<sub>2</sub> differ somewhat from those described in the November RADIO BROADCAST for the original crystal set. These changes have been made in consideration of certain characteristics of the Sodion tube (as outlined in this department last month). The Sodion tube works best, and is most selective, when the input has comparatively few turns of wire, the required wave range being secured by boosting with a high capacity condenser. For this reason, the Sodion detecting circuit is not

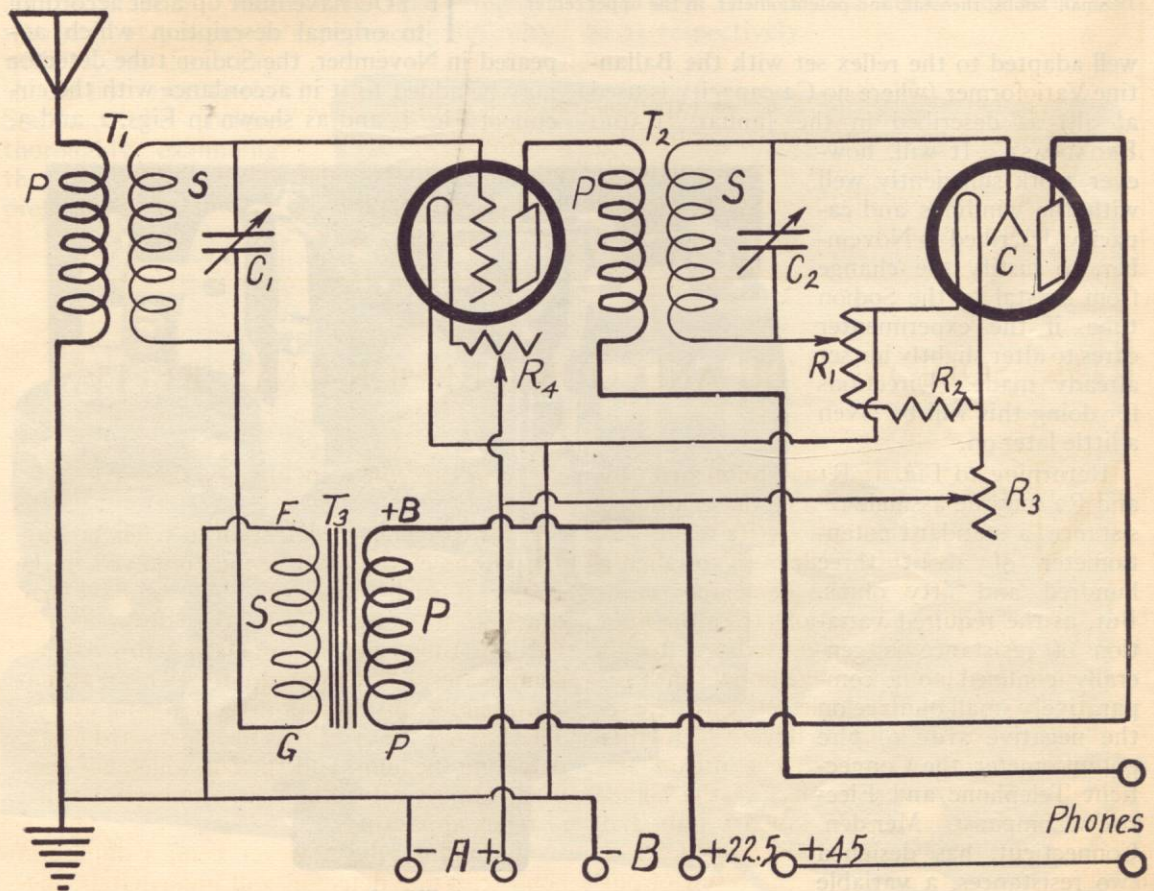

FIG. 1  
The "knock-out" reflex circuit with the Sodion tube for detector



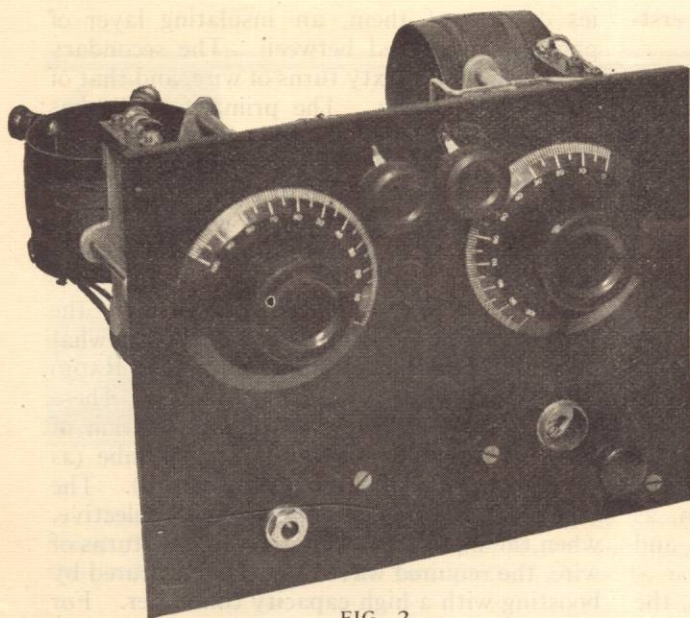

FIG. 2

The original reflex set plus the Sodian tube. Note the two small knobs, rheostat, and potentiometer, in the upper center

well adapted to the reflex set with the Ballantine Varioformer (where no  $C_2$  capacity is used at all) as described in the January RADIO BROADCAST. It will, however, work sufficiently well with the windings and capacity described in November, to justify the change from crystal to the Sodian tube, if the experimenter cares to alter slightly his set already made. Directions for doing this will be given a little later on.

Returning to Fig. 1:  $R_1$  and  $R_2$  may be a single resistance, a standard potentiometer of about three hundred and fifty ohms. But, as the required variation of resistance is generally confined to a comparatively small ohmage on the negative side of the potentiometer, the Connecticut Telephone and Electric Company, Meriden, Connecticut, has designed two resistances, a variable and a fixed one, respectively  $R_1$  and  $R_2$ . The variable

resistance costs \$1.00, and the fixed unit \$.30.

$R_3$  and  $R_4$  are rheostats, and, if the set is made up especially for the Sodian tube, it is suggested that they be of thirty ohms resistance each. This will make possible the correct filament voltages, on each tube, from a common filament source.

The plate potential for the Sodian Tube is 22.5 volts.

The Sodian tube can, of course, be applied to any reflex circuit as described above. The principle of the low input impedance should merely be carried in mind, and some form of a variocoupler, with a variable condenser across the secondary, substituted for the final output R. F. transformer.

#### ADDING THE SODION TUBE TO THE OLD CRYSTAL REFLEX SET

**I**F YOU have built up a set according to original description which appeared in November, the Sodian tube detector may be added to it in accordance with the circuit of Fig. 1, and as shown in Figs. 2, and 3,

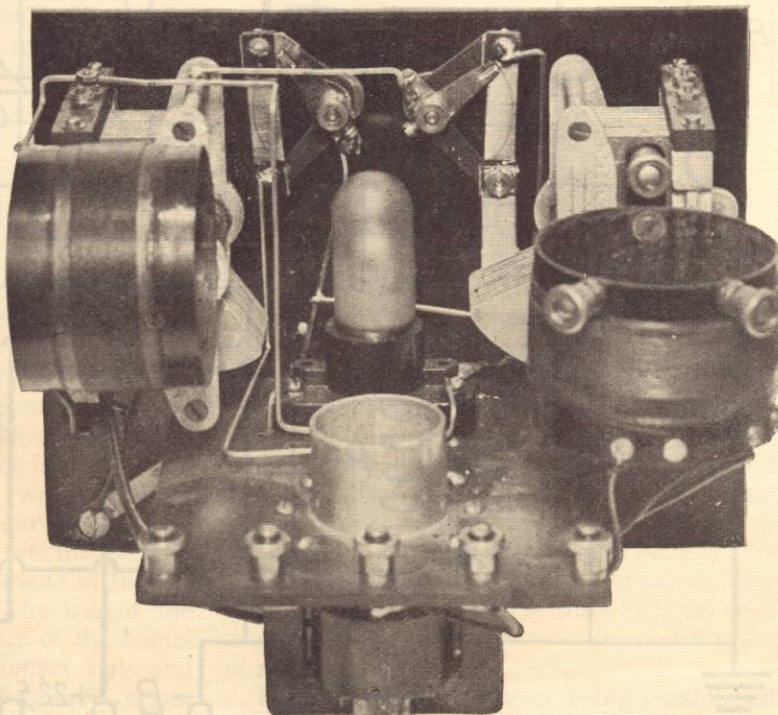

FIG. 3

Showing the back of panel work necessary to adapt the Sodian tube to the single tube reflex



In this case, the reader is advised to buy not merely the Connecticut Company's potentiometer units but also their Sodian filament rheostat. These resistances are most easily mounted in the remaining free space on the panel, and they are uniform in appearance. The socket of the Sodian tube is mounted on the shelf holding the standard tube, placing it close up to the panel.

The only necessary circuit changes are those connections to the secondary of T<sub>2</sub> and to the primary of T<sub>3</sub>. An additional binding post may be added for the 22.5-volt tap for the Sodian tube. The crystal detector is, of course, completely eliminated from the circuit.

#### FIXED CRYSTALS AND THE ONE-TUBE REFLEX

THE use of the Sodian tube, as described in the preceding article, by no means makes obsolete the crystal detector in this circuit. There are many to whom the simplicity and economy of crystal detection will continue to appeal, in fact we use it with great regularity and satisfaction. Readers in this category, who may at present be experiencing difficulty with crystal detection, should not resort to the Sodian tube before thoroughly examining the possibilities of their present system.

Ninety per cent. of the troubles which have bothered the comparatively few interested enthusiasts who have not been able to make this set function properly, have been due to faulty crystal detection. The symptoms of such troubles are as follows:

Oscillation, as evidenced by the reception of a variable beat-note of the transmitting radio-  
phone.

Squealing.

Equal or better detection when the cat-whisker of the detector is lifted from the crystal.

These difficulties may be instantly and permanently remedied by the use of an efficient fixed crystal, such as the Erla, manufactured by the Electrical Research Laboratories, 2515 Michigan Avenue, Chicago, Ill., and the Pyratek, made by the Erisman Laboratories, Washington Heights Building, New York City. These fixed crystals will be supplied by the manufacturers, if the reader is unable to obtain them from a local dealer, for \$1.00 and \$1.25 respectively.

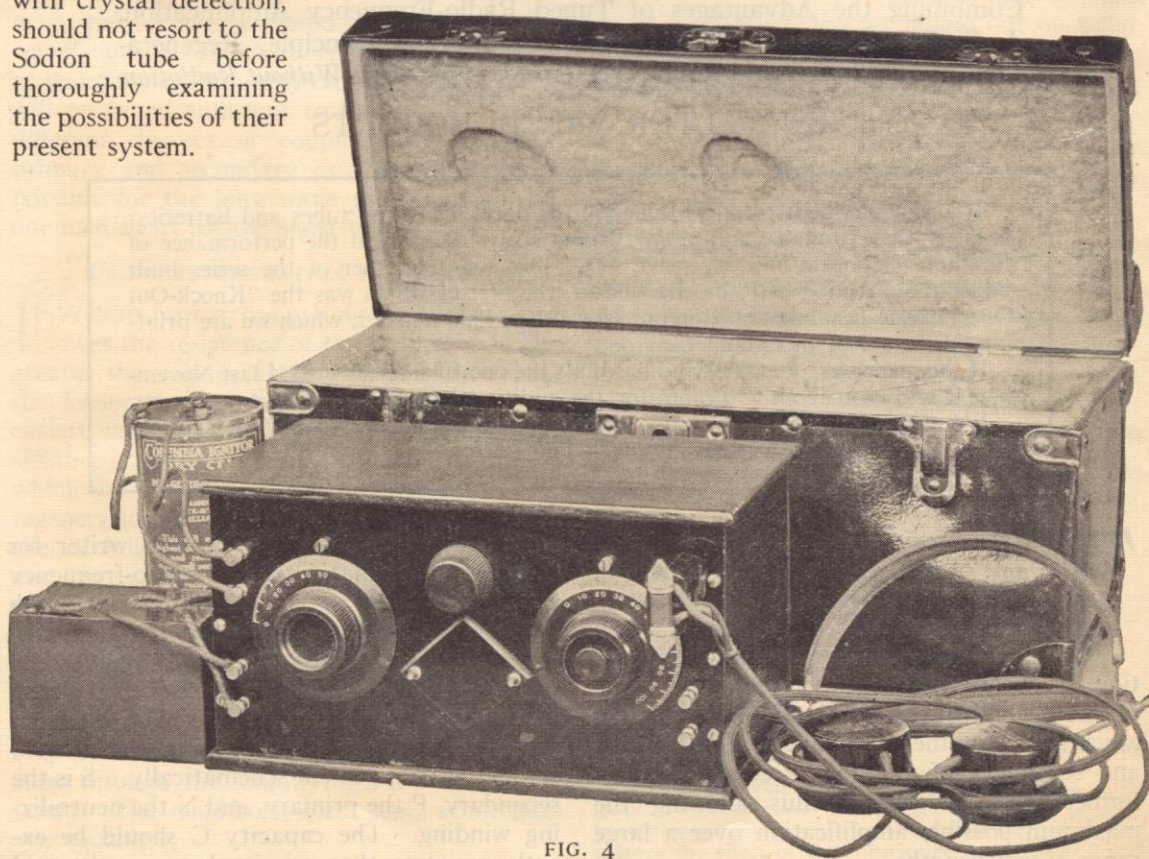
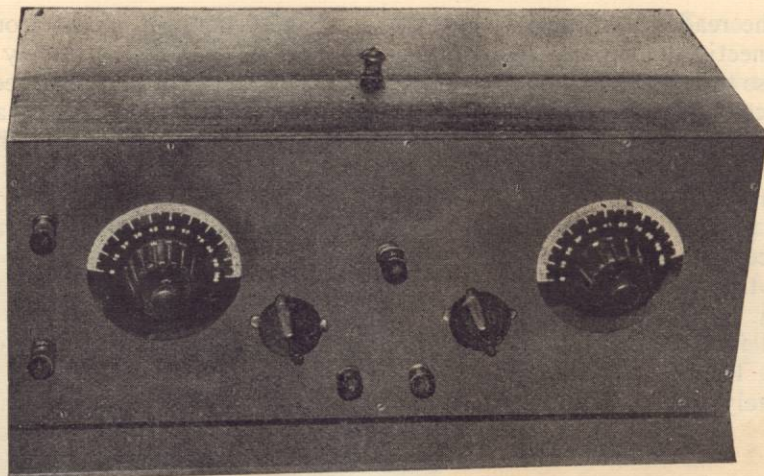

FIG. 4

The ideal automobile radio equipment





FRONT VIEW OF THE COMPLETED SET

This outfit can be built for less than \$50, uses a 201-A and UV-199 tube, is surprisingly efficient in operation and easy to build

## A Knock-Out Two-Tube Set

Combining the Advantages of Tuned Radio-Frequency Amplification, Audio-Frequency Amplification, the Neutrodyne Principle, Regeneration, and Reflexing and Loud Speaker Operation—All *Without Radiation*

By WALTER VAN B. ROBERTS

The set described costs less than \$50 for parts, including tubes and batteries; is fairly easy to make, and as Mr. Roberts says, will equal the performance of far more elaborate and expensive sets. This set is another of the series built under the direction of RADIO BROADCAST, the first of which was the "Knock-Out One-Tube Reflex," described in our November, 1923 number, which we are printing on page 2 of this booklet.

If the reader has the parts and has built the one-tube set described last November, it will cost about \$10 more for the additional parts necessary for this set.

We are rushing the information on this set to our readers, and that explains why we do not show a panel lay-out.—THE EDITOR.

THE circuit to be described is only one of many possible applications of the method which is used to obtain radio-frequency amplification without any tendency toward regeneration. This method is closely related to the ordinary neutrodyne system, but has the advantage that the coupling between primary and secondary of the radio-frequency transformer may be varied, thus allowing the maximum possible amplification over a large range of wavelengths.

The method employed by the writer for overcoming oscillation in the radio-frequency amplifier consists in winding the primary with a pair of wires, thus forming two separate windings coupled as tightly together as is physically possible. One of these windings is used as the primary in the ordinary fashion. The other one is used only to prevent regeneration. Fig. 1 shows the arrangement schematically. S is the secondary, P the primary, and N the neutralizing winding. The capacity C should be exactly equal to the capacity between the grid



and plate of the tube together with the socket and leads. Whatever alternating voltage exists on the plate must be due to alternating magnetic flux linking P. But the same flux also links the similar winding N, which is connected the other way around, and hence, acting through C, produces an effect on the grid which is equal and opposite to that produced by P acting through the grid-plate capacity of the tube. Thus the net "feed back" or tendency to regenerate is completely neutralized (the coils P and S being of course set at such an angle with the coils in the grid circuit that there is no magnetic feed back) *whatever sort of secondary is used, however loosely it is coupled, and however it is tuned.*

If a transformer has a tuned secondary of low resistance, the coupling between primary and secondary should be varied with the wavelength in order to keep the amplification at its maximum value. Practically, however, it will be found sufficient to have two or three different degrees of coupling—for instance, primary and secondary as close together as possible for the long wave range, and about one inch apart for the short wave range.

USING REGENERATION INTELLIGENTLY

**I**F A transformer has a tuned secondary, the lower the resistance of the secondary is, the greater the voltage amplification will be, and the looser the best value of coupling. The easiest way to obtain a very low effective resistance is to employ regeneration in the tube to which the secondary is connected. The use of regeneration in this way will help most when the secondary is loosely coupled to its primary, and the set is then much more selective. By making this tube oscillate, signals are easily picked up by the squeals—the reason that the set is non-radiating is that if the capacity C of Fig. 1 is adjusted just right and there is no magnetic feed-back to the antenna, then no oscillations can get back from the oscillating tube through the amplifying tube to the antenna. The neighbors, bless 'em, won't hear any squeals.

Fig. 2 shows the complete circuit, while

Fig. 3 shows a simplification which is very satisfactory for strong signals, especially if great selectivity is not needed. Regeneration is omitted in the simplified circuit and all couplings are left fixed at a good average value so that only the two variable condensers are used in operating the receiver. Different methods of connecting the antenna to the set are shown in Figs. 2 and 3. The method of Fig. 3 is simpler but a slight hum is likely to be heard if there is alternating current supply in the house.

The outstanding features of this circuit:

1. It will run an hour or so a day for several months on four dry cells.
2. It will operate a loud speaker well enough for all ordinary purposes.
3. It does not radiate and cause squeals in the neighbors' receiving sets.
4. It offers a better combination of sensitivity, selectivity, and quality for the total cost than any other circuit the writer has ever used.

LOW COST AND HIGH COMPARATIVE PERFORMANCE

**T**HIS total cost is very little compared to what most sets giving comparable results would come to after all batteries and tubes are included. To keep down the cost and to make

it easier to build, the set is laid out on a flat board 2 feet by 1 foot. There is room for interesting experimental work in arranging this set behind a panel, and making the layout very compact. Results were more important at first than symmetry of construction.

WINDING THE COILS

**C**OILS A, S, N, P, and T (the tickler) are all wound on the same size cardboard spiderweb coil forms. These are 5 inches outer diameter and have 13 teeth each  $1\frac{7}{16}$  inches long. Coils A, S, and T are all wound with No. 22 wire, going over two teeth, then under two, etc. There are 30 turns on A, a small loop being twisted in the wire at every fifth turns

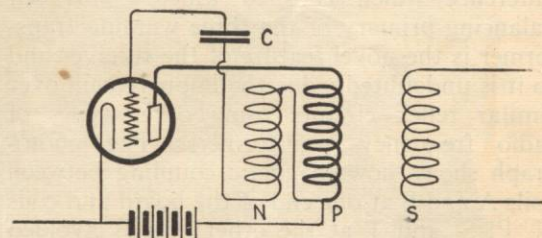

FIG. 1

Fundamental circuit of the method of winding the radio-frequency transformer for this set. N is the primary neutralizing winding and C the neutralizing capacity to balance the effect of the capacity between the grid and plate of the tube



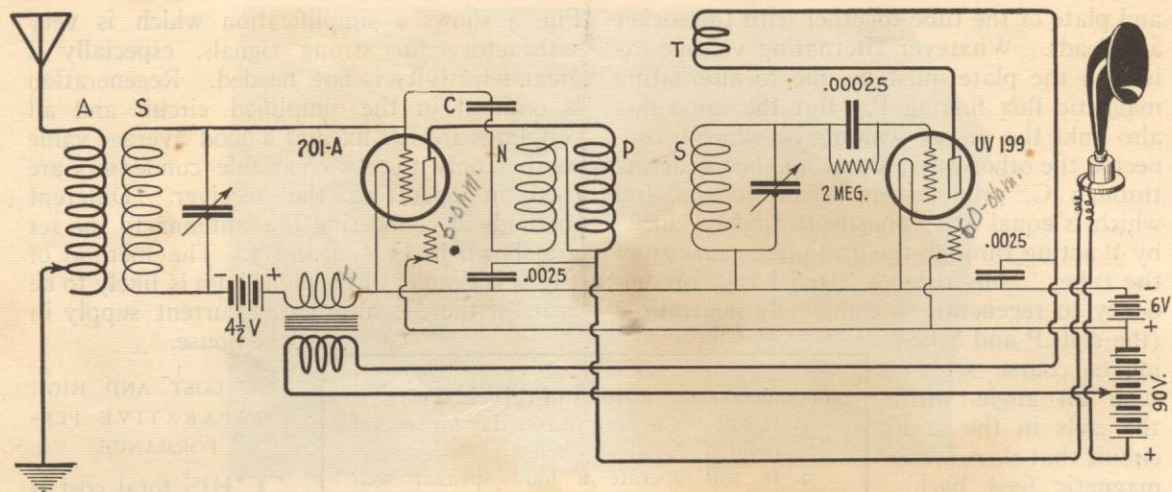

FIG. 2

The complete circuit of the Knock-Out Two Tube Set. This circuit is recommended over the simplified arrangement shown in Fig. 3

The insulation is scraped off these loops and contact is made by a voltmeter clip. S has 45 turns. Both of the coils "S" should be connected so that the lead from the inner turn goes to the grid. T should have 20 turns, or even less if oscillations occur too easily.

The tickler must of course be connected the right way around to get oscillations at all, and this is most easily discovered by experiment. Windings N and P are wound simultaneously on the same spider web form by winding with a pair of No. 26 wires, treating the pair exactly like one wire. In this case wind over one tooth, then under one tooth etc., going around 22 times. There are then two separate windings each of 22 turns. Connect the outer terminal of one of these windings to the inner terminal of the other.

The remaining pair of terminals go to the plate and to the capacity C and it makes no difference which goes to which. This self balancing primary of the three winding transformer is the novel feature of the receiver and to it is undoubtedly due the improvement over similar reflex circuits using other types of radio frequency transformers. The photograph shows how magnetic coupling between coils A and S at one end of the board and coils N, P, S, and T at the other end is avoided by setting them at right angles. The tickler is mounted on the end of a strip of wood that can be slid in and out between a pair of narrow guide strips. The coil containing windings N and P is not arranged to slide, but by loos-

ing up the single screw that fixes its position, it can be set up close to coil S or backed away about an inch and a half. The same arrangement is used for coil A. Both of the coils S are fixed in position.

#### USING THE NEUTRALIZER

THE capacity C shown in the photograph consists of two pieces of copper about the size of a penny separated by a sheet of mica. A piece of paper would do just as well, as the only purpose of the material between the pieces of copper is to prevent their touching, which would short circuit the B battery. Adjustment can then be made by sliding one piece of copper sideways. Another way of getting the capacity C is to have a couple of inches of bus bar stick out from the grid terminal, and slide a piece of spaghetti over it, the spaghetti being wrapped around on the outside with the wire coming from the neutralizing winding. The best way, however, to obtain the capacity C is to buy a little one-plate variable condenser, the plate being about  $1\frac{1}{2}$  or 2 inches in diameter.

The capacity C has to be considerably greater than in the usual neutrodyne arrangement. The adjustment of this capacity to exactly the correct value is of great importance for two reasons. First, to make the set non-radiating, and secondly, to make the operation of the two tuning condensers completely independent of each other. The ordinary way of getting the proper balance with the filament of the first



tube unlighted is impossible because the phones are in its plate circuit.

A simpler way is to make the second tube oscillate by pushing the tickler coil up, then pick up the carrier wave of some transmitting station by the squeal, and then adjust the capacity C. When the correct adjustment is obtained, it will be found that varying the setting of the antenna circuit condenser will not affect the pitch of the squeal from the carrier wave, but only its intensity. This proves that the antenna circuit is not coupled in any way to the oscillating circuit, and hence no oscillations can be produced in the antenna.

If the non-regenerative circuit of Fig. 3 is used, the adjustment of capacity C is even simpler—it is merely varied until a value is found such that the set cannot be made to squeal by any combination of settings of the two tuning condensers. It should be noted that too much neutralizing capacity will cause regeneration just as readily as too little.

GENERAL NOTES

**I**N ANY given set, it is advisable for the user to try connecting the grid return of the detector tube to the + side of the filament. This sometimes gives better results. Also, the best value of the voltage for the B battery should be found by experiment, although 22½ volts will usually do about as well as any.



A NEUTRALIZING CONDENSER  
Which may be used in place of the two penny-size pieces of copper suggested for the neutralizing capacity for the first tube

A good long antenna of low resistance is of much more importance in this set than in an ordinary regenerative set, because the resistance of the antenna circuit is not wiped out by regeneration. The ground lead should be firmly clamped or well soldered, and the antenna wire made of copper.

WHAT THIS SET HAS DONE

**A**FTER the set is working at its best, the results should be noticeably better than can be had from a first class single circuit regenerative receiver with one stage of audio ampli-

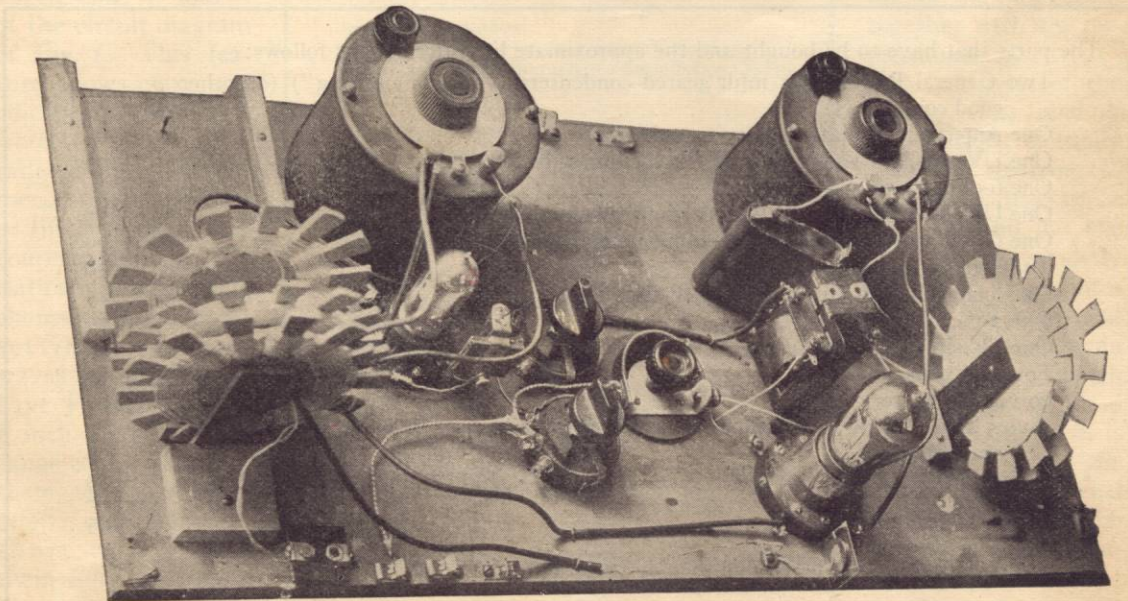

THE LABORATORY MODEL

Worked out by Mr. Roberts. With this simple layout, he was able to tune-in Havana on a loud speaker while Newark was operating, and WJAZ while WJZ was on the air. His experiments were conducted at Princeton, N. J.



*O-Binding Posts.*

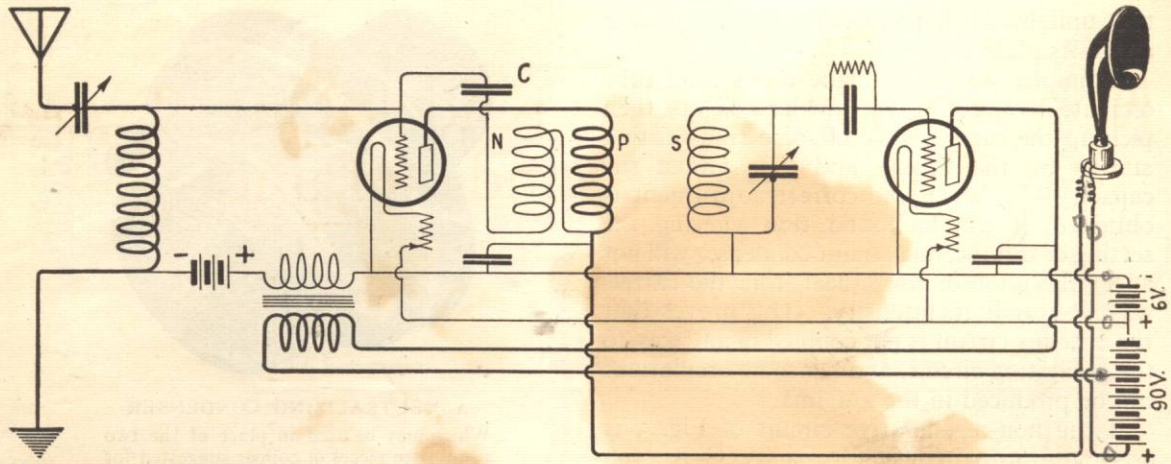

FIG. 3

A simplified circuit which may be used. The number of tuning controls is reduced to the two variable condensers. But the results obtained from the circuit shown in Fig. 2 are far superior to those secured from this circuit, although its adjustment is not quite so simple

fication. The selectivity should be better than that of a three-circuit regenerative receiver, and the tuning easier and less critical. The outfit shown in the photograph has been tried out against two well known makes of neutrodyne and gives about the same results (only one stage of audio being used in the neutrodyne sets, of course.) Using a single wire antenna 150 ft. long and about 20 ft. high

located in Princeton, N. J., WJAZ in Chicago was heard on a Western Electric 10D loud speaker without any interference from WJZ. PWX, Havana, was heard on the loud speaker while WOR, about 35 miles away, was working. These stations are too close together in wavelength to be separated completely, but the selectivity of the set was such that PWX was only slightly less loud than WOR.

The parts that have to be bought and the approximate list prices are as follows:

Two General Radio .0005 mfd. geared condensers ("table mounting") (or other good condensers)	\$12.00
One Amertran audio frequency transformer	7.00
One UV 201-A or C-301-A or DV-2 vacuum tube and socket	5.75
One 6-ohm rheostat	1.00
One UV-199 or C-299 or DV-1 vacuum tube and socket	5.75
One 60-ohm rheostat (or two 30 ohm rheostats in series)	1.00
Two .0025 Micadon condensers	.70
One .00025 Micadon condenser with clips for grid leak	.45
One 2-megohm grid leak	.75
One 4½-volt flashlight battery	.50
Four dry cells	1.60
90 volts B battery	7.00
Five 5 and 10 Cent Store spider web coil forms (these may be made at home without difficulty)	.25
Screws, wire, wood, etc., about	1.50
<b>Total</b>	<b>\$45.25</b>

(Loud Speaker is not listed due to wide variation in prices)



# How to Build the Knock-Out Two-Tube Set Behind a Panel

By WALTER VAN B. ROBERTS

It is worth knowing that this circuit has given excellent satisfaction as to distance, is not hard to build, and is sensitive and *does not radiate*. Mr. Roberts began work on the circuit last December and his original descriptive article appeared in RADIO BROADCAST for April. —THE EDITOR.

**I**N RESPONSE to the demand for a better looking arrangement of the circuit described by the writer in the April issue of RADIO BROADCAST, the sets shown in the photographs have been built, and work about as well as the original arrangement. For one set the coils were wound on five and ten cent store spider web forms, and a five and ten cent store brass arm was used to operate the tickler coil. The other set makes use of coils built especially for this use by the Turney Laboratories, and can be wired so as to appear somewhat neater. It has adjustable coupling between coils P and S of the circuit diagram of Fig. 1. This feature allows maximum efficiency over the whole wavelength range, but it is recommended that only two or three values of this coupling be used. Variation of this coupling changes the condenser settings. For long waves, say 450 to 600, have P and S about  $\frac{1}{2}$  inch apart, for the range 300 to 450 have them, say 30 degrees apart, and for very short waves, have them fully separated. They can of course, be left at some compromise position, as in the

other set, and never varied. Both sets work about equally well.

## HOW TO BUILD THE SET WITH HOME MADE COILS

**F**OLLOWING are instructions for building the set using home made coils: Fig. 4 shows how to drill the panel. In case it is necessary to use other makes of parts than those specified, drill only the holes for their shafts according to Fig. 4, and then drill holes for their supporting screws wherever necessary.

A baseboard  $\frac{1}{2}$  inch thick with cleats  $\frac{1}{2}$  inch thick is used. Fig. 3 shows the positions of parts on top of the baseboard, together with the approximate arrangement of some of the wiring. The rest of the wiring is easily done by referring to the circuit diagram of Fig. 1. Coil A, the antenna coil, is mostly hidden in the photograph. Its inner lead goes to the antenna binding post, which is the upper left hand one when the panel is looked at from the front. The ground binding post, which is just beneath, connects to the rotating contact arm. The left contact point (viewed from the front

### These parts are needed:

*If the set is entirely home built.*

- 2 General Radio (or equivalent) .0005 mfd. condensers.
- .005 mfd. micadon
- .0025 mfd. micadon
- 2 25-ohm Cutler-Hammer resistance strips
- Amertran audio-frequency amplifying transformer
- 6-ohm rheostat
- UV-201-A socket
- UV-199 socket
- Grid condenser with grid leak clips; .00025 mfd.
- condenser, grid leak, 3 megohms
- bus bar (neutralizing capacity "C")
- bus bar for connections
- spaghetti
- binding posts
- panel, formica or bakelite
- wood sub-base
- contact points
- switch lever
- 3 coils (3 ten cent store spider web forms, wire, about No. 26 B & S)

*If the set uses purchased coils—*

same as above, except parts for the coils are omitted. Turney Laboratories coils and mountings.

Because of the great variation in price of these various parts, no price estimate is given. Any piece of apparatus which will do the same work as a special one mentioned in the article may be substituted for it.



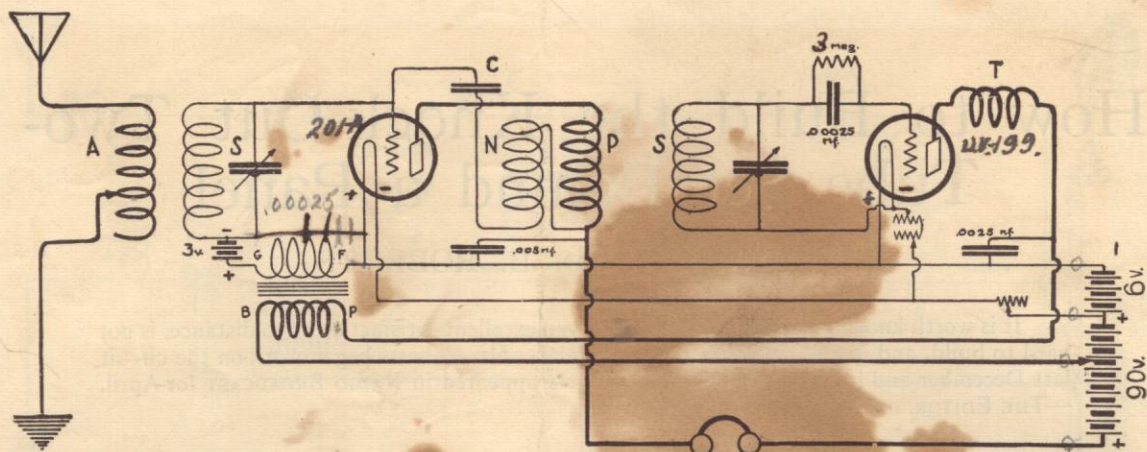

FIG. 1

The Roberts circuit.—Revised as originally printed last month. Several changes have been made. A 3- instead of a 4½-volt C battery is used, a .005 mfd. condenser is added in series with winding N, and in the grid return of the UV-199 is made through the — filament

of the panel) is connected to coil A one turn from the inner lead. The next contact point connects to the second turn. Point No. 3 goes to turn No. 5. Point No. 4 to turn No. 10. Point No. 5 to turn No. 20. Point No. 6 to turn No. 30. Point No. 7 to turn No. 40, which is the outer lead from the coil. Coil A is wound of No. 22 d.c.c. wire, winding over two teeth, then under two teeth, etc.

Coils S, one of which hides A in the photograph, are wound in a similar fashion, and with the same kind of wire, but there are 44 turns

and no taps. The separation between coils A and S should be  $\frac{1}{4}$  to  $\frac{1}{2}$  inch between centers. They are set slightly askew so that they "aim" at the centers of the coils at the other end of the board.

Coil T, the tickler, is the coil mounted on the rotating arm, and has about 18 turns of any kind of magnet wire wound any way. (If oscillations occur before the tickler is turned down somewhere near the other coils, there are too many turns on it. If oscillations do not occur when turned well down toward the other

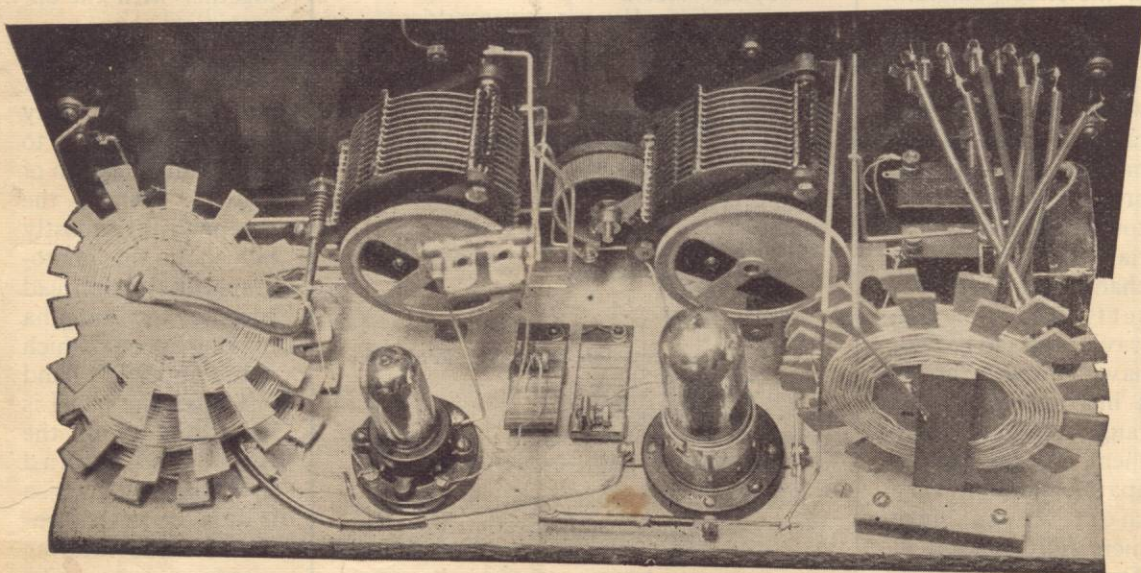

FIG. 2

The home made set behind a panel. As can be seen, the construction is quite simple



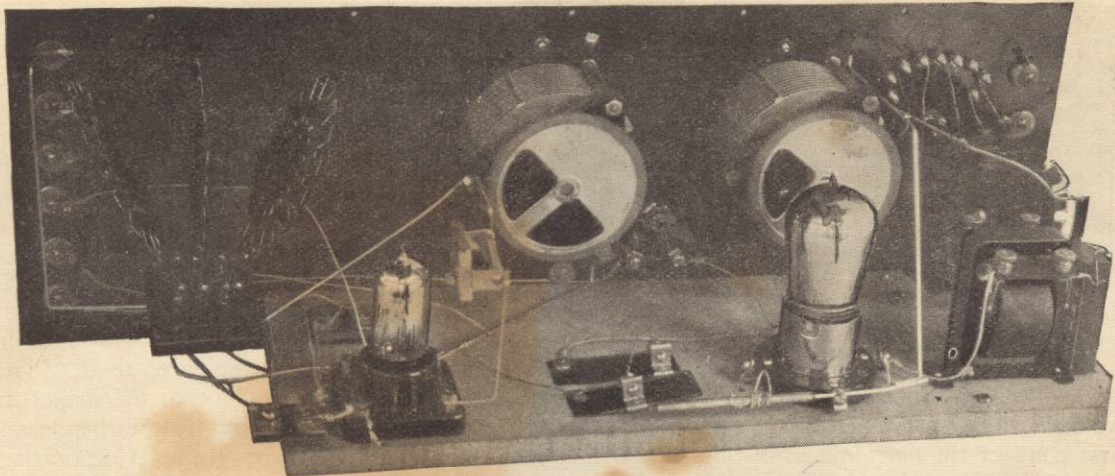

FIG. 3  
Behind the scenes of the Roberts circuit using the manufactured coils

coils, the tickler is probably connected backward.)

The coil containing the windings N and P is the one lying flat on the baseboard. Coil S is screwed down on top of it, and separated about  $\frac{1}{2}$  inch by a piece of wood with a hole for the screw to go through. N and P are each 20 turns, being wound both at once by simply using a pair of wires instead of a single wire to wind with. Wind over one tooth, then under one, and so on. Use wires no larger than No. 26, preferably of different colors so that no mistake will be made in connecting up.

The sliding contacts on the two Cutler-Hammer 25 ohm resistance strips should be set so that there are about 35 ohms altogether. One slider at the end (about 20 ohms) and the other

at the middle, will be about correct. Never remove the 201-A tube from its socket while the filament of the UV-199 is lighted, as this will increase the current through the 199. Connect the outer lead of the coil S which is coupled to coil A, to the grid of the 201-A tube, but the inner lead of the other S coil to the grid of the 199. The stationary plates of the condensers are the ones that are connected to the grids in both cases as is indicated by the diagram. If the rotating arm on which the tickler is mounted happens to be bent the wrong way, saw it off and solder together the other way around. Be sure that the terminal marked P on the primary of the Amertran is connected to the tickler, *not* to the B battery terminal. If some other make of transformer is used, try

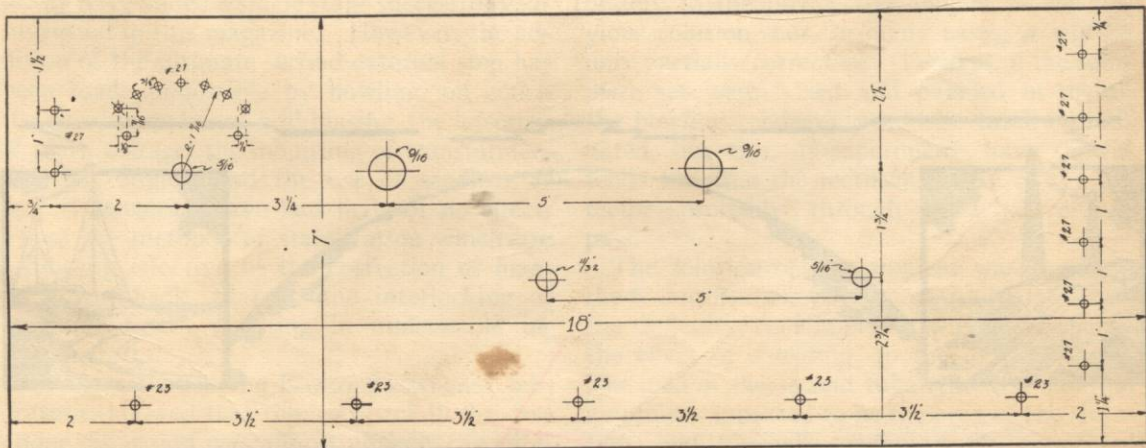

FIG. 4  
Panel layout for the home built set. The panel with manufactured coils is three inches longer



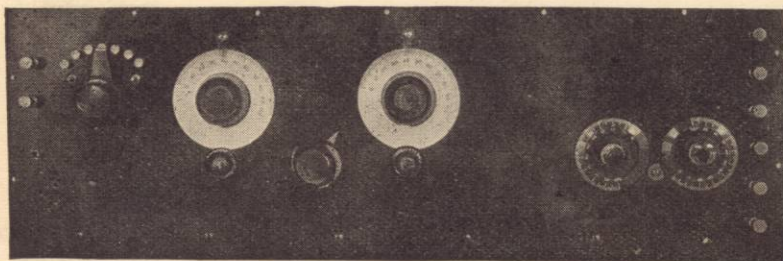

FIG. 5

Front view of set using manufactured coils. The experimenter has plenty of leeway in building his own set of this type

connecting its primary both ways to see which works right. In connecting windings N and P, first connect the *outside* lead of one to the inside lead of the other. Be sure not to simply connect the outside lead of one to its own inner lead.

The neutralizing capacity, C, is easily made by leaving two inches of bus bar projecting from the grid terminal of the 201-A tube. This is covered with spaghetti. A brass tube connected to the free end of winding N is then slipped over the spaghetti, fitting snugly. (Bare wire wrapped tightly around the spaghetti will do instead of the tube.)

See the article in the April RADIO BROADCAST for directions for adjusting the capacity C, and for the theory of the operation of the set.

#### THE SET WITH PURCHASED COILS

THE set using the Turney coils was built on a 21-inch panel to make it less crowded. The baseboard, however, is only 16 inches

long. Coils A and S are mounted 2 inches from the panel and parallel to it. The circuit is the same as in the other case, although the wiring is slightly altered to suit the different arrangement of parts.

In both sets, General Radio .0005 mfd. condensers with slow motion gearing are used. The rheostat is 6 ohms. The 201-A socket is a Paragon, while for the 199 tube, either Paragon, General Radio, or Radio Corporation sockets are recommended. Binding posts, contact points and panel, can be got at the five and ten cent store.

To get an idea of what performance to expect, the following is of interest: WGY is received quite satisfactorily on the loud speaker in Princeton, N. J. at any time of day, and KDKA can be heard faintly. At night KHJ is barely audible on the loud speaker, while KGO is almost loud, and can be separated perfectly from WLW, whose wavelength is only 1 per cent. different. (The respective settings of these two stations on the set using the home made coils are 23 and 22½.)

The original set described in the April RADIO BROADCAST is now being used by Dr. L. A. Turner of the Dept. of Physics, Princeton University, who has heard KGO on the loud speaker, using an indoor antenna!

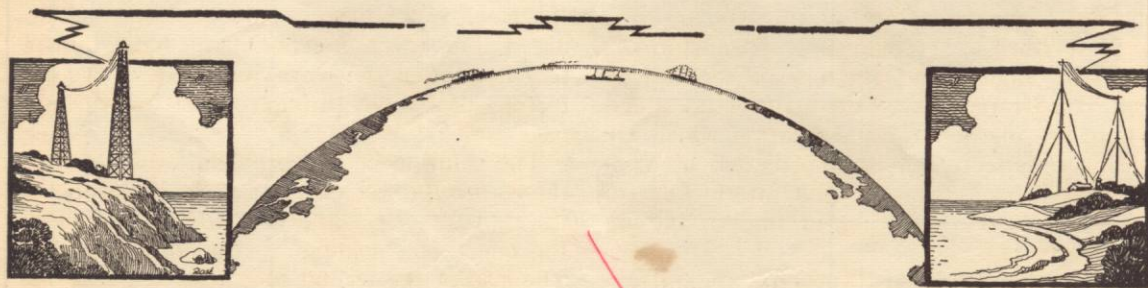



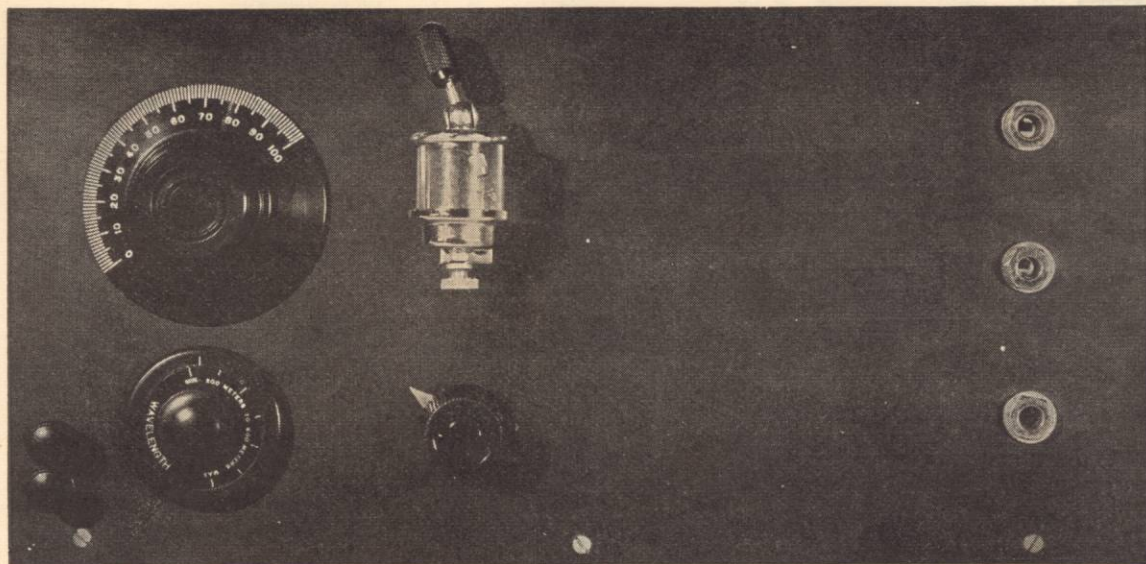

THE RESULT OF CAREFUL WORKMANSHIP  
Front view of the reflex set described below

## A "Knock-Out" 3-Tube Set

### A "How To Make It" Article

By ZEH BOUCK

**E**VER since the publication in the November RADIO BROADCAST of the "knock-out" one-tube set developed by Mr. Kenneth Harkness, enthusiastic readers, sensing the possibilities of further amplification, have clamored for the addition of two audio stages. Many have added a single stage successfully, as suggested in this magazine. However, the addition of the ultimate second external step has been made impossible by howling, on which the usual remedies of grid biasing, the lowering of plate voltage, the mounting of transformers at right angles, and the use of separate A and B batteries have had little or no effect. These are methods of stabilization which are ordinarily effective in the correction of magnetic feed-back, that is, the interlocking of magnetic fields, resulting in undesirable induced effects.

Investigation in the RADIO BROADCAST laboratories showed that the feed-back in the case under discussion was almost entirely capacitive—capacity between the exterior amplifier and the reflex part of the circuit through ex-

ternal objects, such as the operator, near-by electric wiring, etc. When the phones were used on the last or second stage, the receiver squealed loudly when the tuning dials were approached but the squealing ceased the moment the operator was grounded. Shielding will probably suggest itself immediately to the prospective builder as the obvious solution, but, in many cases, it will be only partially corrective. Perhaps, if the complete set were boxed and paneled in metal, the howling tendency would be totally eliminated, but this, as experiments have shown, tends to lessen the rectifying effect of the detector—probably through capacitive by-pass.

The solution of the problem was found in the RADIO BROADCAST laboratory, by localizing the difficulty, and applying what is probably the effect of shielding, to the localized area. The grid of the second tube (the first external amplifier) appeared to be the crux of the situation, and a small condenser, C<sub>2</sub>, connected between this grid and the ground, completely and definitely eliminated the howling. In



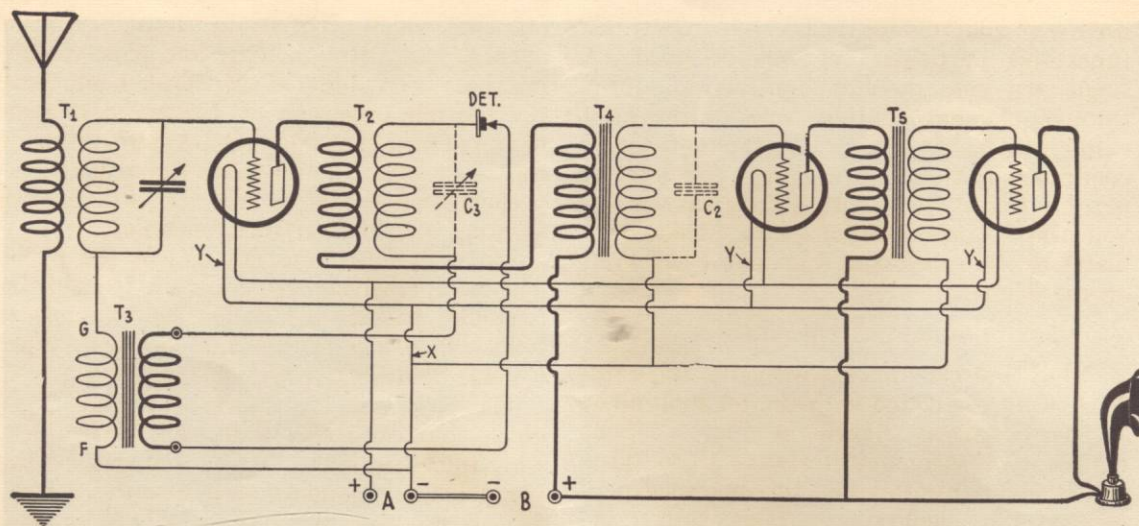

FIG. 1

The "Fundamental Circuit." Build your set with this as a basis if you do not care to follow explicitly the instructions given by the writer, or if you cannot obtain the parts designated. You may use such rheostats, jacks, transformers, etc., as you have on hand and as are within the latitude always allowed the constructor

this particular, and rather unusual connection, there exists also, perhaps, a neutrodyning effect—the system applied so successfully to the elimination of capacity phenomena in radio frequency amplification.

#### THE CIRCUIT

WE HAVE drawn up for the benefit of our readers, two circuits, the fundamental circuit, Fig. 1, and the specific circuit, Fig. 2. The fundamental circuit, which we shall first consider, is the basis on which the majority of enthusiasts, who are unable to obtain the exact instruments used by RADIO BROADCAST in building the set, must work.

T<sub>1</sub> and T<sub>2</sub> have been described in detail in the November RADIO BROADCAST, and a very interesting variation, the use of spider-webs, is covered in the "R. B. Lab." Department for this issue. If a homemade T<sub>2</sub> is used, the tentative condenser, C<sub>3</sub> capacity, .0005, will be necessary. If a Ballantine Varioformer is employed, this condenser is done away with. The audio transformers, T<sub>3</sub>, T<sub>4</sub>, and T<sub>5</sub> may be any reliable make, such as Acme, Federal, Amertran, etc., with a ratio of approximately five to one. The same make or type of transformer need not be used throughout the circuit. "Det." represents any good crystal detector.

C<sub>2</sub> is the anti-capacity condenser, and should be as small a capacity as is effective. Generally a .0005 Micadon suffices. This condenser, incidentally clears up other objectionable noises,

and noticeably reduces A. C. induction from near-by lighting wires (electric lights in the vicinity of the operating table, etc.). In a few instances, and with some tubes, this condenser may be unnecessary.

No rheostats are shown in the fundamental circuit. If UV-199's are used, and a steady three-volt source is available, the filament adjustment may be eliminated. If the builder desires to use individual rheostats, one for each tube, they will be connected in the filament circuit at "Y". If a single rheostat is decided upon, as is most likely, it should be inserted at "X". In all cases of resistances, it will be noted that the secondaries of the external audio transformers are brought down to the battery side of the rheostats. This places a desirable negative potential on the grids.

No jacks have been indicated. The constructor may use any type he possesses, or can obtain conveniently, filament control or otherwise. Various types of jacks have been pictured and described in the April issue of RADIO BROADCAST. While jacks are of course advisable, the set will function at all times on the last amplifying stage.

#### THE SPECIFIC CIRCUIT

THE set as built by RADIO BROADCAST employed the T<sub>1</sub> exactly as described in the November issue. T<sub>2</sub> is a Ballantine Varioformer. T<sub>3</sub>, T<sub>4</sub>, and T<sub>5</sub> are Amertran transformers. Standard sockets (De Forest) were



used with adaptors for the UV-199's, for which tubes this particular set was designed. A single ten-ohm rheostat controls all tubes through filament lighting jacks of the most easily obtainable type. C<sub>2</sub>, the anti-squeal condenser, is a .0005 Micadon. The detector is a De Forest stand with a Fada cat-whisker and arm. Forty-five volts were used on the plates of the tubes, and four and a half volts on the filaments.

BUILDING THE SET

OUR first experiments with this apparatus were conducted with the set built up on a base-board, as shown in Fig. 3. Such temporary construction is always a good idea, and is invariably followed by veteran experimenters. It facilitates various tests, and makes possible the definite designing of the ultimate apparatus. The base-board measured sixteen by ten inches, and Fig. 3 shows very plainly the distribution of the instruments. It will be noted that, even in the temporary installation, wiring has been done with at least a semblance of care. Neat wiring consumes a bit more time, but it is worth the extra trouble. In the case of inoperation, it eliminates careless running of leads as a possible and frequent source of difficulty.

Figs. 4 and 5 show the completed set of so simple design that any one can follow our instructions. It was with simplicity in mind that RADIO BROADCAST has eliminated all constructional gymnastics, such as shelves, brack-

ets, etc., which often strain the ability of the average fan. Straight base and panel mounting has been adhered to throughout, with the possible exception of T<sub>1</sub>, which may be mounted on a three inch square shelf resting on top of the reflex audio transformer, if the experimenter is unable to accomplish the feat of securing it to the variable condenser.

Fig. 6 is a working drawing of the panel. The comparatively large hole, 1 3/4 inches in diameter, passing the Ballantine Varioformer (which should be of the panel mounting type) is made by drilling a circle of small holes.

The base (see the insert of Fig. 6) is 13 inches long, six inches wide, and 3/4 inch thick. This thickness makes a firm support for the panel which is fastened to it by three screws, 3/8 inch up from the bottom. This, in conjunction with rigid wiring, holds the panel quite firmly. The base, one inch shorter than the panel, makes possible the use of a cabinet with grooved sides into which the panel is slid.

Fahnstock clips have been employed for the battery connections, and are screwed to the rear of the base, between the audio transformers as shown in the insert. "A" indicates the A battery terminals and "B" the high voltage connections.

CONSTRUCTION HINTS

THE panel should, of course, be drilled, grained if desired, and fastened to the base-board as the first step in construction. All panel instruments, C<sub>1</sub>, T<sub>1</sub>, T<sub>2</sub>, detector,

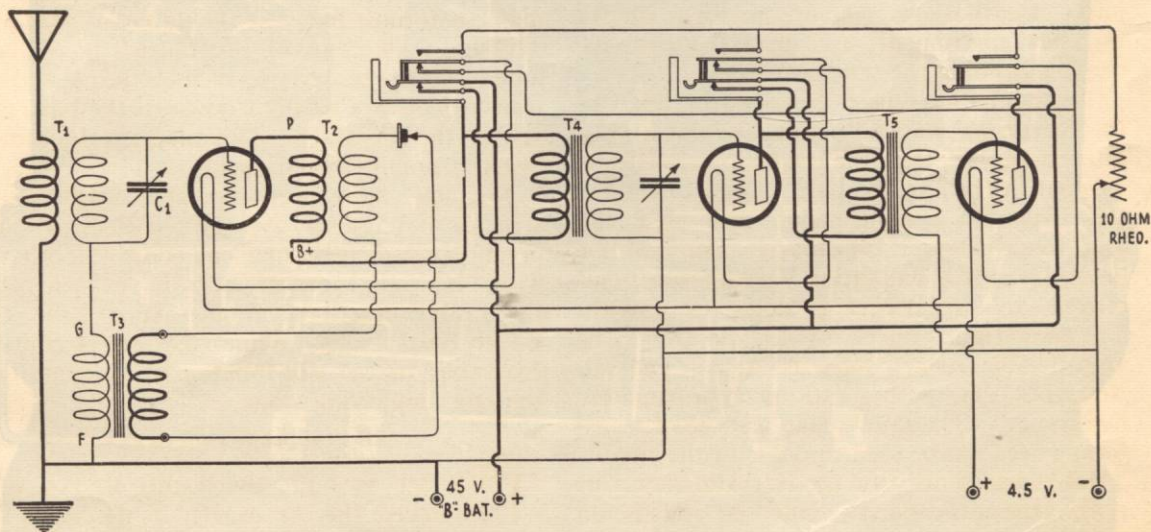

FIG. 2

The "Specific Circuit." This is the modification of the fundamental circuit used by RADIO BROADCAST in building the set described



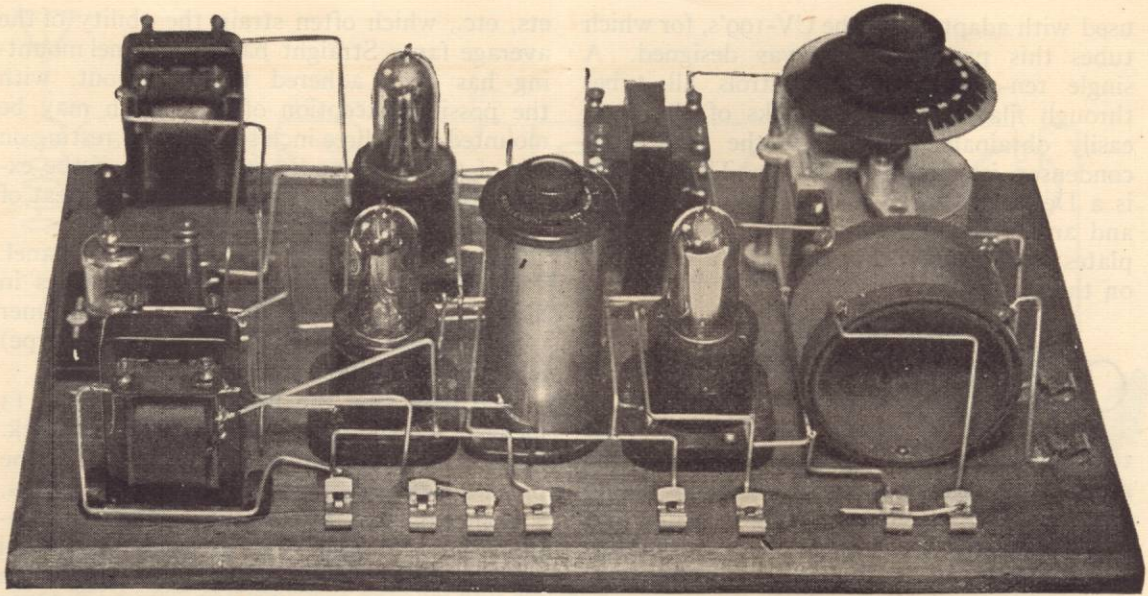

FIG. 3

The temporary set, built up on a base-board, where it was completely tested, and when it was proved satisfactory it was properly wired on the panel, as seen in Fig. 4

rheostat and jacks, and antenna and ground binding-posts, are next mounted, along with the sockets and T<sub>3</sub> on the base. The positive filament connections on the sockets are wired with a single straight piece of bus-bar wire, and

the connections of the reflex or tuning circuit are made complete. T<sub>4</sub> is next mounted, along with the Fahnstock clips, two on each side. All filament control connections are now made, as well as those to transformer T<sub>4</sub>.

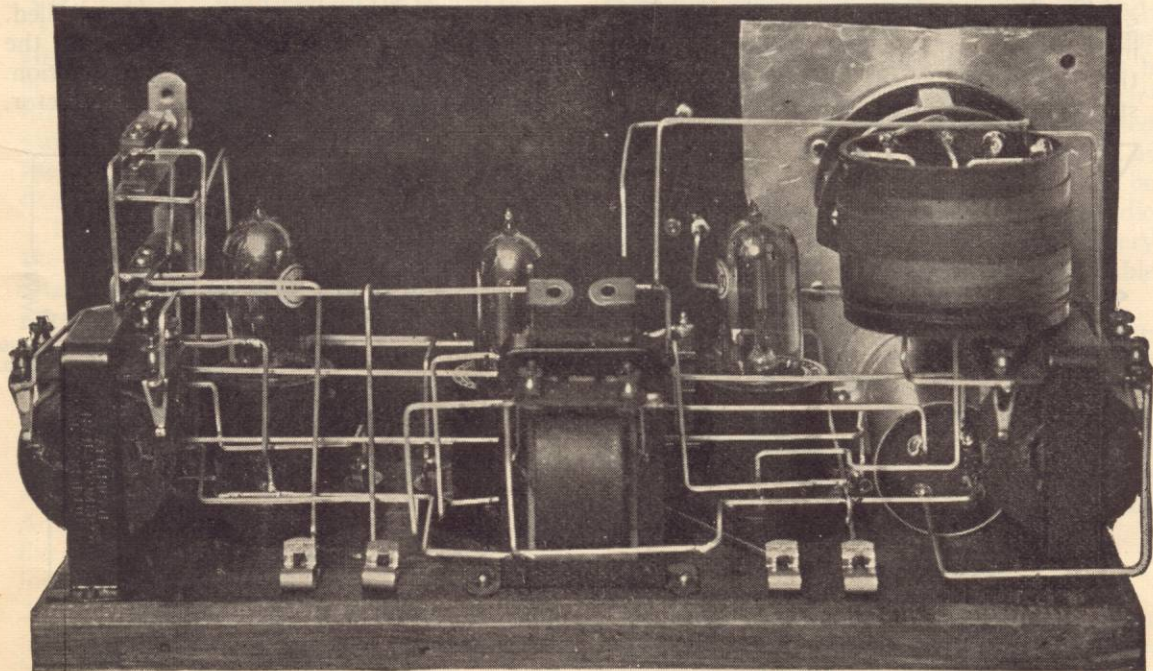

FIG. 4

Rear view of the completed set. Note the neat wiring, and the partial shielding



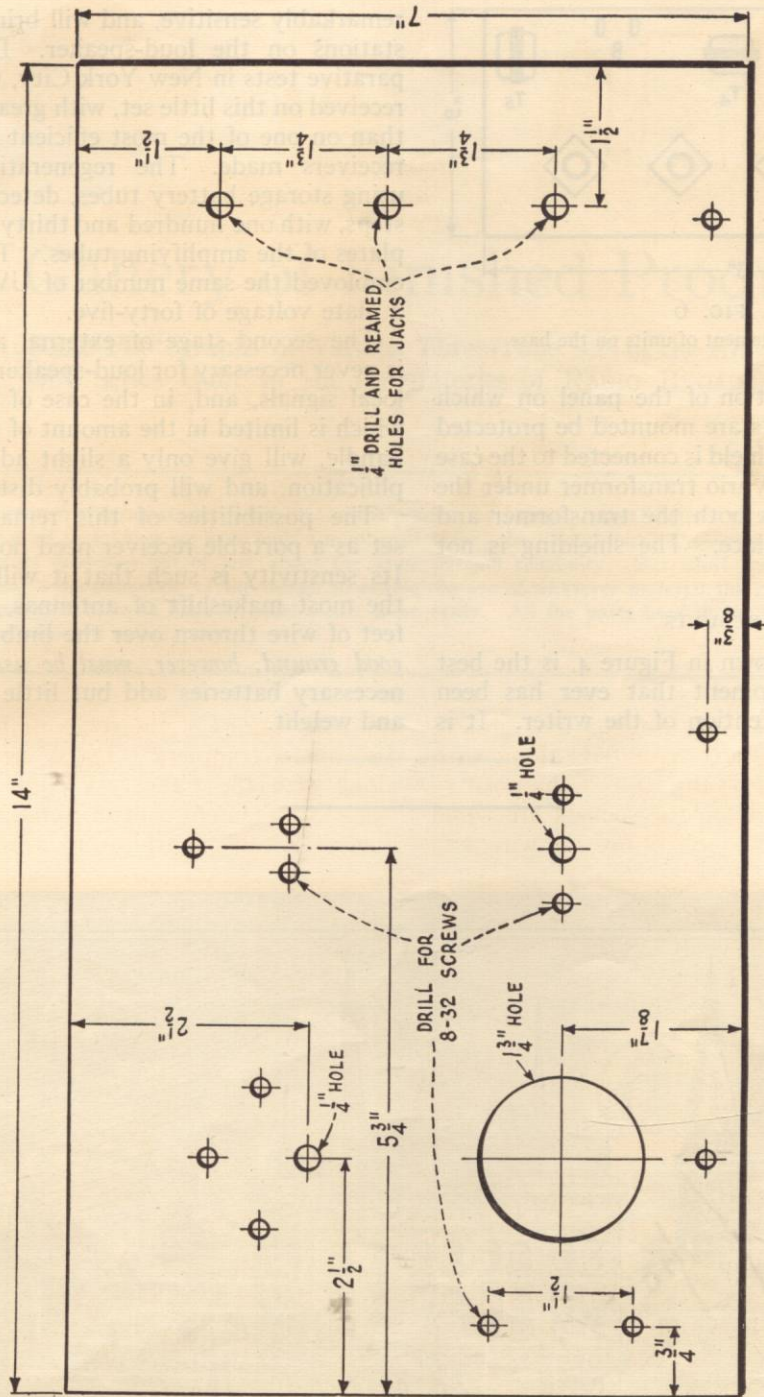

FIG. 5  
Working drawing of panel, half actual size

Allowance in wiring the jacks must be made for the position of T5, which is the last instrument mounted and wired. It is suggested that wiring be done with bus-bar or hard-drawn copper wire, avoiding all types of insulation. Wiring, for the sake of neatness and efficiency,

should be run straight and with right angles, and, needless to emphasize, all joints soldered. Shielding may be used, and in some cases it may eliminate the necessity for the anti-capacity condenser, C2. However, it is suggested that the shielding be localized, and only



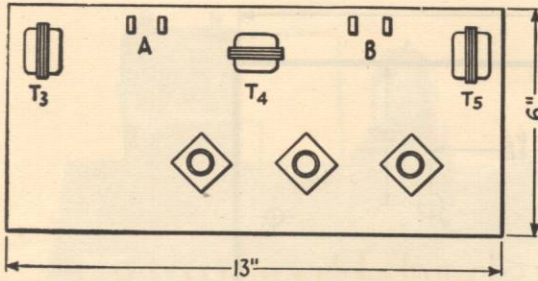

FIG. 6

Showing arrangement of units on the base

that one third portion of the panel on which the tuning elements are mounted be protected in this way. The shield is connected to the case of the Ballantine Vario transformer under the clamp which holds both the transformer and the shielding in place. The shielding is not grounded.

#### RESULTS

THE set, as shown in Figure 4, is the best dry cell equipment that ever has been brought to the attention of the writer. It is

remarkably sensitive, and will bring in distant stations on the loud-speaker. During comparative tests in New York City, Chicago was received on this little set, with greater intensity than on one of the most efficient regenerative receivers made. The regenerative set was using storage battery tubes, detector, and two steps, with one hundred and thirty volts on the plates of the amplifying tubes. The reflex set employed the same number of UV-199's, with a plate voltage of forty-five.

The second stage of external amplification is never necessary for loud-speaker reception of local signals, and, in the case of the UV-199, which is limited in the amount of power it can handle, will give only a slight additional amplification, and will probably distort signals.

The possibilities of this remarkable little set as a portable receiver need no delineation. Its sensitivity is such that it will operate on the most makeshift of antennas, such as 125 feet of wire thrown over the limb of a tree (*a good ground, however, must be used*), and the necessary batteries add but little to the bulk and weight.

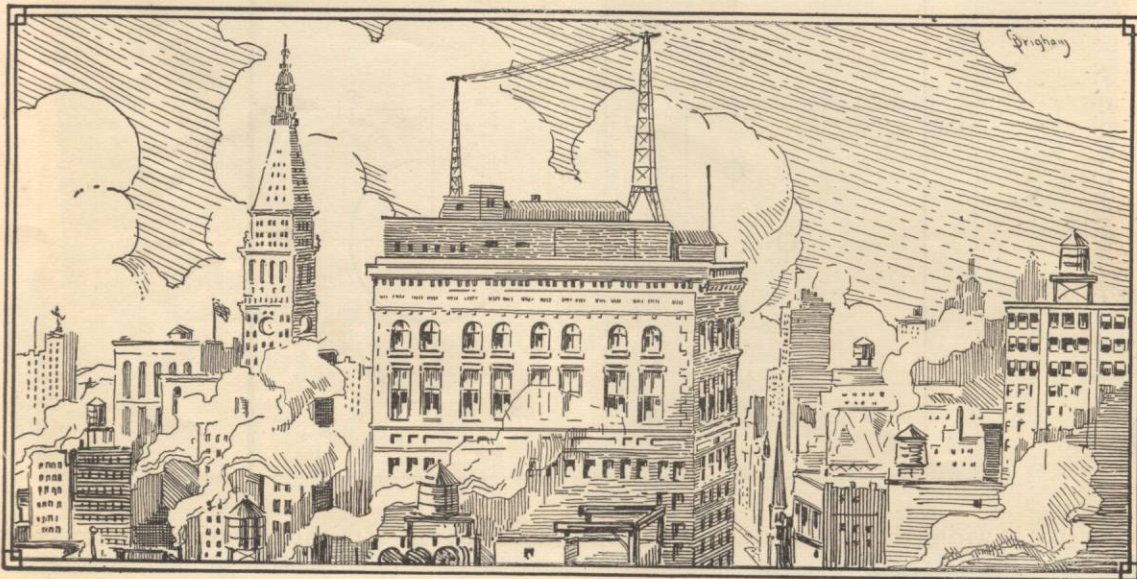



# A Gallery of Finished Products

Some Photographs of Various Three-Tube Sets of the Knock-Out Series Built in the Laboratories of RADIO BROADCAST

In order to give our readers some idea of the possible variation in actual details of which they may avail themselves we have built a number of three-tube, "knock-out" sets—each somewhat different in design but of just about the same over-all reliability. Our effort was directed toward a simplification of the design to enable the use of whatever material the constructor happened to have on hand or could secure most easily. All the parts used in these receivers are of standard manufacture.

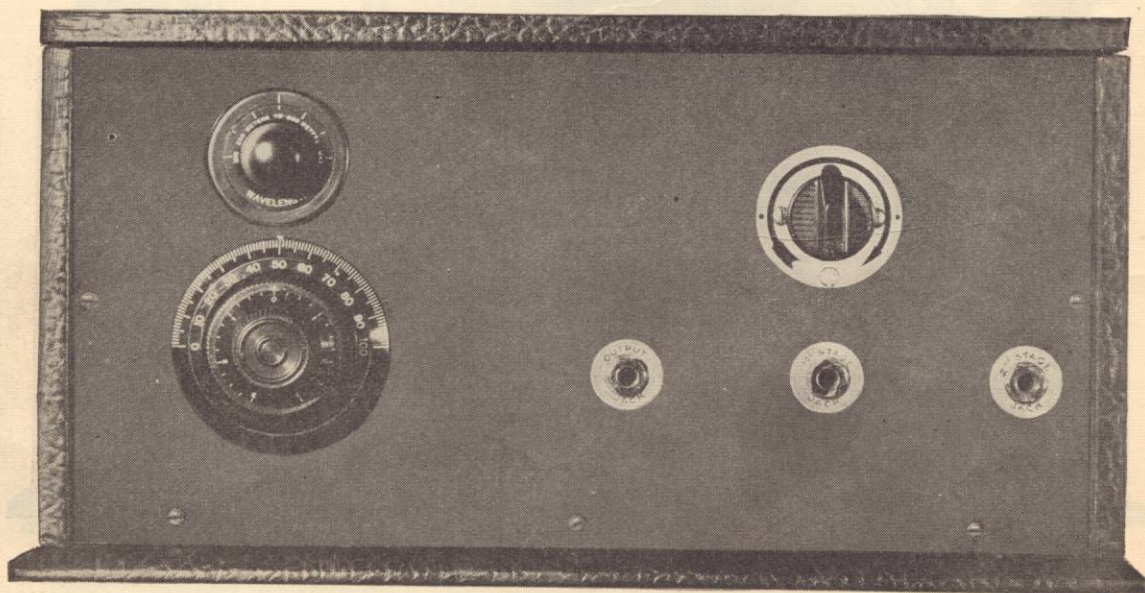

## TO CONSERVE SPACE

We have found the layout shown here very satisfactory. A vario-transformer is used in the R. F. circuit, and the vernier dial on the antenna tuning inductance is a feature worthy of notice. A single rheostat regulates all three tubes and automatic filament control jacks are used. There are but two tuning adjustments and the receiver is very easy to operate. The appearance is improved by the rheostat and the nickel markers encircling each jack. The cabinet is of imitation leather. This receiver was built by the editor of RADIO BROADCAST. The kitchen table was the work bench and ordinary tools were used



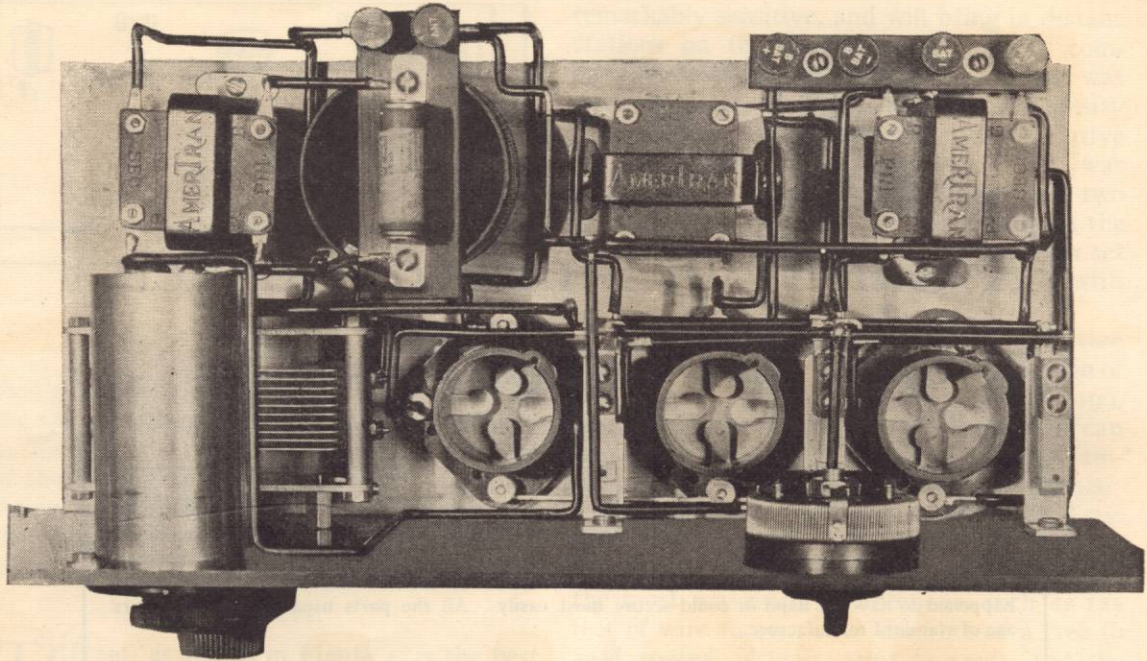

FROM THE TOP

There is not much room to spare, but the wiring is not too complicated. The assembly is made on the base-board and panel at the same time. The base-board is made the size of the inside bottom of the cabinet. The antenna inductance is held in place by a bakelite strip which also carries the fixed crystal detector and binding posts for antenna and ground. Standard sockets have been used so that any tubes will operate in this receiver. Cushion sockets are, of course, preferable

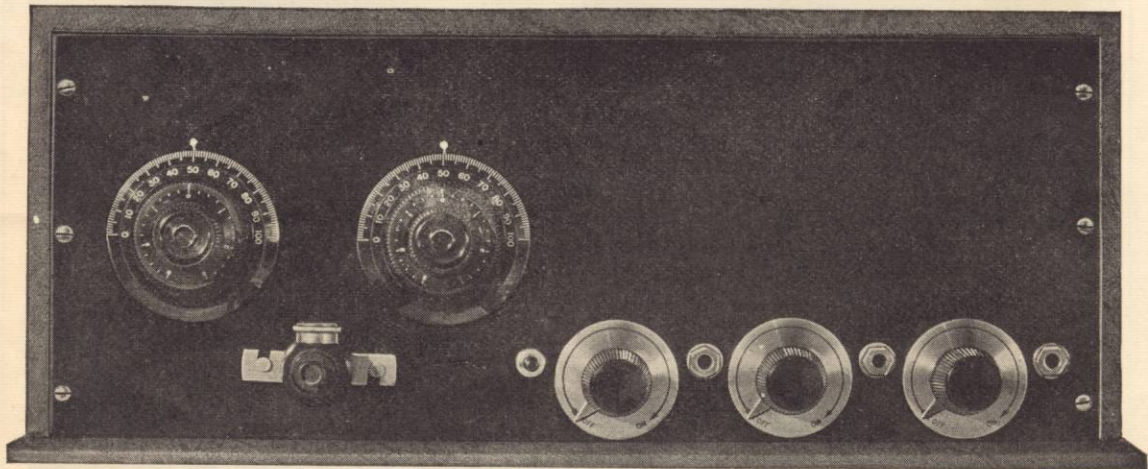

THIS STANDARD 7 X 18 PANEL LAYOUT

Is particularly attractive to the builder who would rather use wired units than do all the wiring himself. The R.F. transformer and aerial tuning transformer used in this arrangement are similar to those described in the first article of this series, but the variable condensers used with them are of lower capacity (.00029 mfd. maximum.) All the tube sockets, jacks, transformers, and rheostats are in one unit which is now being marketed and the unit is attached to the main panel after six holes have been drilled in it. In this model, we have used an imported crystal detector of unique design though any reliable crystal detector (fixed or adjustable) of domestic manufacture will do. A battery switch has been included for convenience. The jacks in this case are not of the filament control type



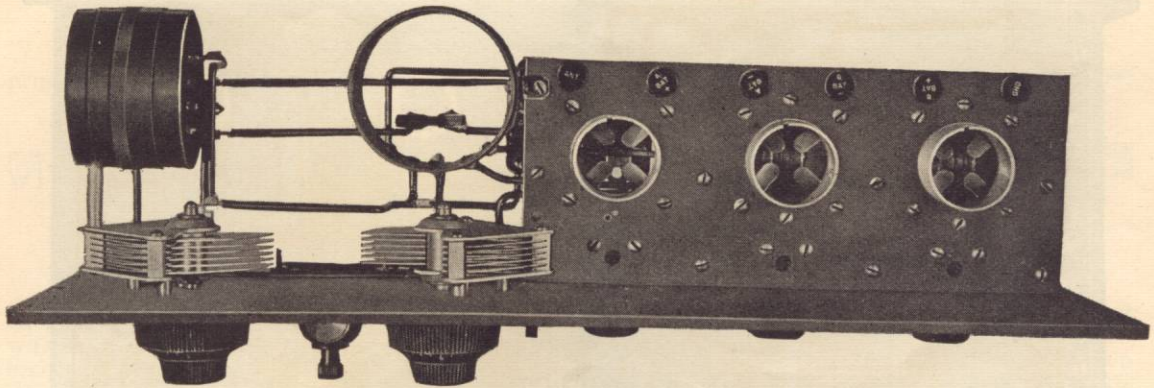

TOP VIEW

Assembly of this receiver is a simple matter as may be seen from this angle. Most of the real work has been done by the manufacturer of the amplifier unit

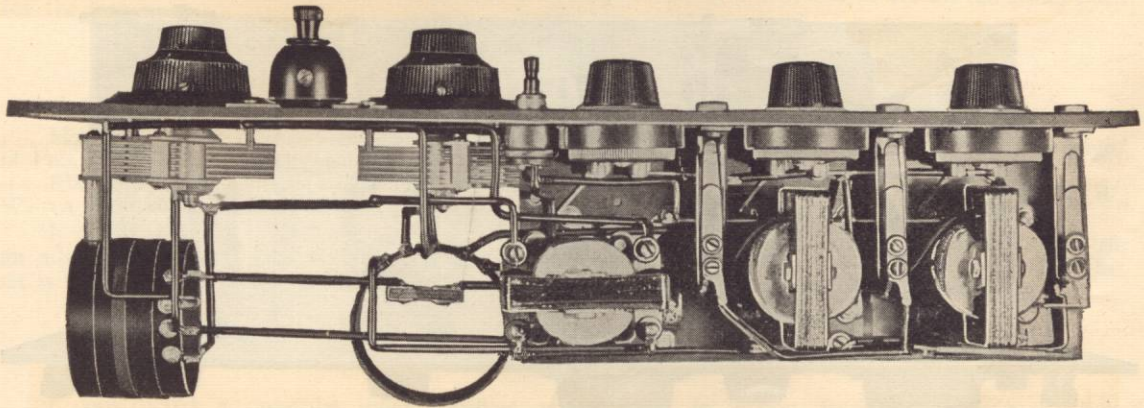

BOTTOM VIEW

As proof of the statement made above examine this photograph

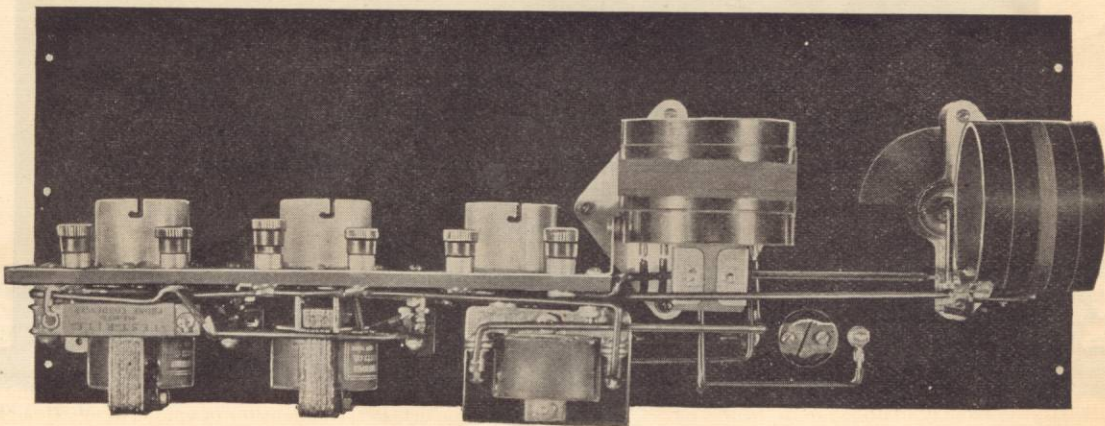

REAR VIEW

Is this not a creditable looking job for a receiver built at home? It is very easy to duplicate



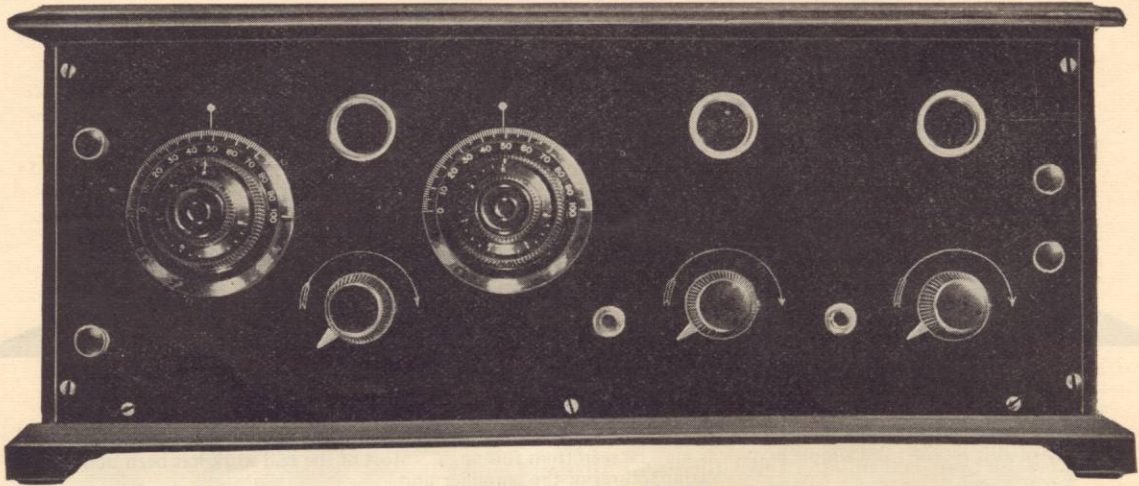

#### ANOTHER MODIFICATION

In this case the antenna and ground posts as well as those for the loud speaker are on the front panel. Small windows fitted with metal bezels are provided to permit ventilation; though they are hardly necessary, some people like their appearance

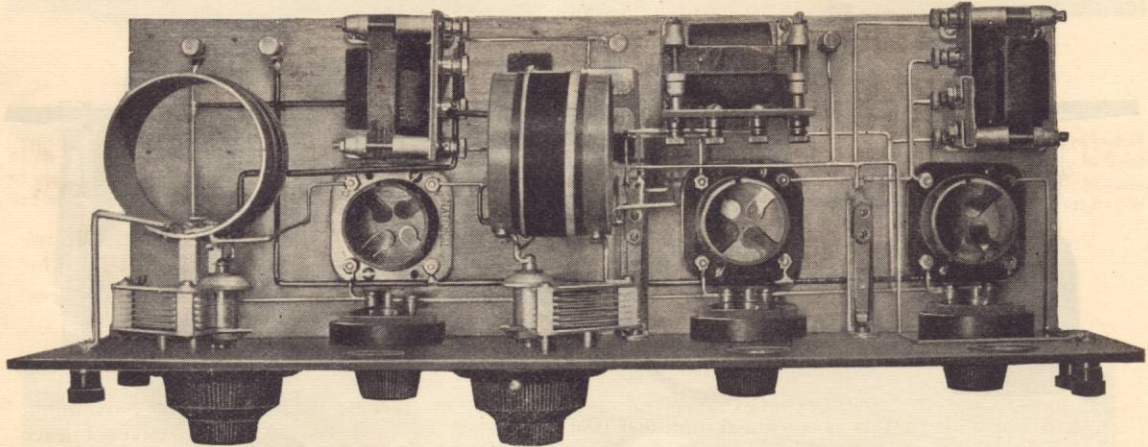

#### TOP VIEW

For a clean-cut wiring job this arrangement can hardly be improved. The only unit not visible is the fixed crystal detector which is directly beneath the right hand inductance as shown in the rear view

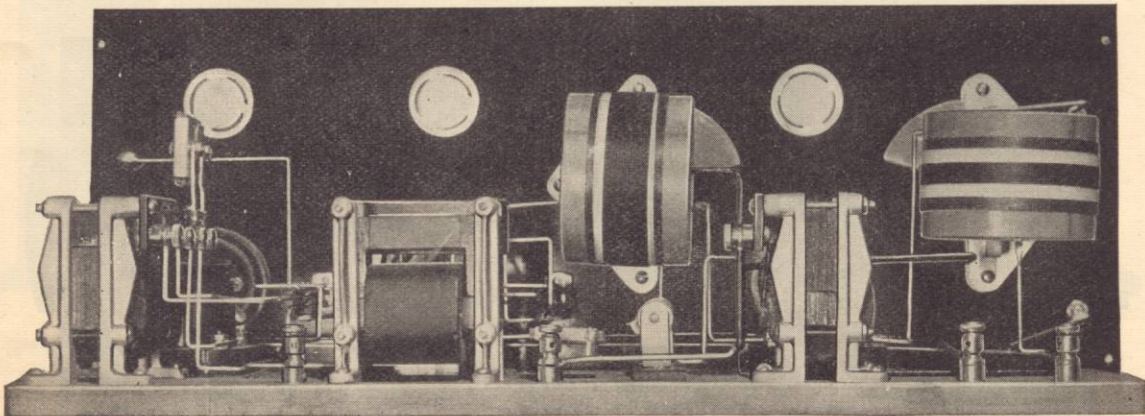

#### REAR VIEW

Note the crystal unit under the left hand inductance unit. The layout of the equipment is simplified if you compare the three views of this receiver on this page



## Here Are a Few of the Hundreds

Of letters from satisfied builders of the one-, two-, and three-tube receivers described in this reprint:

I have constructed the "Knock-Out" reflex set described in your November issue and am very much pleased with it. It is excellent for DX and, with an additional audio amplifier, I have had WTAM, Cleveland, on the loud speaker.

Richard Selman,  
5908 Mansion Pl.,  
Woodside, L. I.

Having built your one-tube set which was in November RADIO BROADCAST and found that we could run a Magnavox as loud as a Victrola with a medium needle. Our antenna was 100 ft. with a 66,000 volt line on one side and a 2,300 volt on the other side. They were about 30 ft. on each side, not a hiss, nothing but clear music from these stations: KYW, WGY, KDKA, WOS, WOC, WMC, WOAW, WDAP, WFAA, and others. We have received all these and others on an inside antenna 30 feet long.

I have just finished making the 3-tube set on page 325, Feb. 1924 issue. On the inside antenna we got KYW and WMC on the magnavox. You could hear them 400 ft. from the house, but some of the more distant stations were not so good.

I bought 3 copies of the Feb. issue and have only one left. The fans around here not only read it but eat it, I guess; anyway they are gone and one that is left is much used as are all the issues back for the last year.

Yours till regenerative sets stop squealing,

G. E. Miller,  
30 West Milwaukee St.,  
Janesville, Wisconsin.

Here is a list of stations received with a knock-out one-tube set, using a 301-A bulb, the night of Feb. 9th. 9 P. M. to 2 A. M.:

PWX, WOR, WTAM, WGY, WOO, WTAV, CKAC, WJAZ, WRC, WOAW, WDAP, KYW, WFAA, WSB, WDAF, CFCN, WGR, WPAL, KFKB, KPO, KFI.

I built this set according to plans published in the November RADIO BROADCAST. I use an adjustable crystal detector, a Bradleystat, and a vernier condenser on transformer T-1. This set is hard to beat.

A. J. Hammerle,  
1426 Christy Ave.,  
Louisville, Ky.

I constructed a one-tube reflex receiver as described in RADIO BROADCAST for November, 1923, and will say that it is a "knock-out" as you claim. With a Magnavox loud speaker I have been able to get all of the well-known large stations in the South and East, and also Portland, Oregon. Using phones alone, most of these came in too loud for comfort. The first night I tried I got KFI in California much clearer than I was able to get it on standard 3-tube set at the same time. I just want to tell you how much I appreciate the information you have given in your magazine.

C. P. Carlson,  
Department of Science,  
Evelieth Public Schools,  
Evelieth, Minn.

I have recently built the knock-out one-tube receiving set described in your November issue, and I think it was a real scoop for your magazine as hundreds are building this little wonder.

Otto Bank,  
908 Edwards Bldg.,  
Cincinnati, Ohio

After building the one-tube reflex knock-out, I had to write and tell you of my appreciation of its performance. The results are splendid. Using two sets of phones, I can hear Texas, Los Angeles, Detroit, etc., and if I use one set I can attach them to a homemade loud speaker and hear KFI about 10 ft. away quite distinctly. All the stations are tabulated and there is no guesswork as to what station you might hit; and trying to find a new station, by knowing the wavelength you know just about where your dots have to be. It's an all around family set as my kid sister can operate it.

H. R. Varcoe,  
Brandon, Manitoba



Myself and other friends have hooked up the one-tube reflex as outlined in your November issue. Each one of us seems to be getting different results. I got very loud signals from local stations and while I brought in several distant stations there was very little volume and tuning was not very selective. I could hear KYW, WEA, and WIP all at the same time. I changed transformers, crystals, and tubes with little or no results and finally reversed the secondary windings on the audio transformer, putting the grid to ground. This did the trick, bringing in local stations twice as loud and enabling me to tune in each station previously mentioned as well as numerous others. With the additional step of audio I have been able to "loud speak" stations as far west as Chicago.

A. E. Bradley,  
Western Union Telegraph Co.,  
169 Congress St.,  
Boston, Mass.

I am a regular subscriber to your magazine and have built the one-tube reflex set described in your November issue. I cannot say that I do not obtain remarkable results. In fact, from Milwaukee, I have tuned in Denver, San Antonio, Texas, New Orleans, Atlanta, and New York City, besides 55 intermediate stations.

Paul Ronayne,  
490 40th St.,  
Milwaukee, Wisconsin

In appreciation of your article in the November issue describing the one-tube reflex, I thought I would let you know my results with same as it happens to be one circuit which justifies the claims made for it, and you perhaps will be pleased to receive data from outside sources regarding it.

I, in common with many other radio fans, have tried most all of the circuits that appeared in the last year or so in search of the perfect receiver and have gradually discarded them for one reason or another. I honestly believe that for an all purpose one-tube receiver this one-tube reflex is the answer to date. This is not flattery as to the best of my memory this is the first testimonial I have ever written and only do so in the interest of the "game." . . . Publish some more data on this receiver as receivers of this class will help the good work along.

W. H. Simonson,  
American Lead Burning Co., Inc.,  
30 Church St.,  
New York City

I have written you several times about my two-tube reflex outfit which was published by you in the December issue of RADIO BROADCAST. The set is now working very much to my satisfaction, thanks to you. So far, I have received programs very clear from 35 stations; some 1,500 miles distant.

Howard F. Acton,  
43 Couch St.,  
So. Norwalk, Conn.

Am writing to tell you that I built the one-tube set and was so pleased that I added one step of audio as per one of your recent issues. It sure is a "knock-out."

Thanking you for putting this circuit before your readers, and assuring you that I am looking forward for any improvements that you develop and urging you to keep up the good work, I remain

Joseph L. Lanz,  
529 Sixth St.,  
Brooklyn, N. Y.

I received my copy of the April number, purchased the material and started out to build the one-tube reflex Tuesday, the 18th. It required three evenings for me to build the set as I wound my own coils and did the entire job, drilling, soldering and all in my den without disturbing the other members of the household, which indicates how simple the set is to build.

The set is a wonder. It is equal to a three tube set I have been using and better than any of the dozen other one, two, and three tube sets I have tried out. It is the most consistent performer I have ever seen, considering the cost and size of the outfit.

Charles F. Fitzgerald,  
2009 Franklin St., N. E.,  
Washington, D. C.



I think so much of the knock-out with the two steps of audio that I couldn't resist writing to you. I have built this little wonder from infancy, beginning with the one-tube reflex, then the one step, then the two-stepper. At this writing I am listening to Davenport (WOC) with grave fear of waking my little girl sleeping upstairs. I am twelve miles from Buffalo and it comes in so loud it can be heard 500 ft. away from the house, with doors closed.

Thinking you would be interested in knowing what results were being obtained by your readers I have written you. I've tried all kinds of sets but this is the baby for me. With the greatest respect to the RADIO BROADCAST, I remain

George Stagers,  
Snyder, N. Y.

You may be interested to know that I have made the one-tube reflex as per diagram in RADIO BROADCAST of November, 1923. It is by far the best one-tube set I have ever made and have never heard one to equal it. Last night I picked up KPO, San Francisco, quite plain and did not consider it very ideal radio weather. It is no trouble at all to get Hastings, Atlanta, Fort Worth, and stations east of Denver.

Dr. L. A. Badger,  
318 Van Buren St.,  
Jamestown, N. Y.

I want particularly to thank you for emphasizing the real merits of the "Knock-Out" circuit. I'll not expatiate for that is superfluous. Have built four of these sets, each a little better than its predecessor and with nine sets now in my laboratory in the presence of super-heterodyne, neutrodyne, 6-tube R. F. and others of the best type sets, I truly think this is the most satisfactory all 'round set I've ever built or tried. Thanks to RADIO BROADCAST. You'll detect from the foregoing that I'm quite an enthusiastic booster for you.

Spencer Carleton, M. D.,  
101 West 78th St.,  
New York City

I am using a one-tube reflex circuit as described in November issue of RADIO BROADCAST and am getting the most unexpected results. By experimenting with different aerials and grounds and several crystals, have found the set to be very selective and absolutely noiseless and have secured great distance and volume with selectivity. Some of the results are as follows:

Have received KFI, Los Angeles five nights in succession understanding every word spoken and music with extra good volume. On two occasions have been able to use loud speaker understanding clearly every word about two feet from horn. Have received KHJ, Los Angeles, three nights this week hearing distinctly every word spoken and music volume good. Have received Mexico City, volume and clearness extra good. Have received numerous stations from Denver eastward, also Porto Rico and Cuba, (2 stations).

Powerful stations such as Kansas City, Oklahoma City, and stations around N. Y. and Chicago can be distinctly heard over large room through loud speaker.

I am very grateful to RADIO BROADCAST for this hookup, for it has surprised everyone who has listened to it, even some of the hard-boiled old-timers. And has compared favorably in volume to regenerative circuits using detector and two audio stages and greater distance together with being absolutely noiseless except for static and spark, and have found that the proper crystal will eliminate oscillations.

B. R. Linton,  
Box 144,  
Hapeville, Ga.

The April issue of RADIO BROADCAST is certainly great. I think that it is about the best number you have yet put out. Keep it up!

You are to be congratulated on having Mr. Zeh Bouck on the staff of RADIO BROADCAST as editor of the "Lab" department. The developments on the reflex circuit are practical and progressing toward something a great deal better than any other such set that I know about. It would be great if the best points of the knock-out one, two and three tube set you have described could be combined and utilize the Sodian.

I have heard KGO at Oakland with my one tube set.

Maynard Knights,  
Herkimer, N. Y.



I have just completed one of the single-tube sets described in the November issue of your magazine. I must say that it is by far the best single tube set I have ever seen. I tested it out last night and some of the more distant stations heard were: WTAM, 1,850 miles, WHB, 1,300, WJAZ, 1,500, CFUC, 2,100 miles. Besides these, many more stations were heard. I am using a C-301A tube with 90-volt B battery. My aerial is about 100 ft. long and 20 ft. high and is composed of one solid copper wire, size 14. I have tried many sets and dozens of hookups but this is by far the best. I consider it as good for DX work as my three-tube regenerative set.

Russell Jayne,  
Davenport, Wash.

I have just completed a one-tube reflex which you call the "knock-out" and it works fine. I get Los Angeles, 400 miles away on the Baldwin "C" loud speaker. The next thing is to hook up the two stages of audio on it as given in the last RADIO BROADCAST.

H. W. H. Penniman,  
12 Locust St.,  
Santa Cruz, Calif.

I am deeply appreciative of the one-tube reflex set, your contribution to radio and feel that the article in November was the finest, most concise and plain it has been my pleasure to read and try.

W. H. Engle,  
2149 Fargo St.,  
Los Angeles, Calif.

I cannot express too much praise for the wonderful Reflex Circuit, which was published in the November issue of RADIO BROADCAST. I had failed twice before with reflex circuits, one a well-known circuit, the other a "New Type." The former had seven controls including the rheostat. The latter had five controls.

Thomas J. Cass, Jr.,  
450 Maywood Ave.,  
Los Angeles, Calif.

Absolutely ignorant of the mysteries of radio I picked your RADIO BROADCAST from a number of publications at a newsstand. From it I successfully made the one-tube reflex following to the two-stage extra audio amplification. Am watching and hoping for additions to this set which will make it second to none.

Charles J. Russell,  
204 W. Fremont St.,  
Stockton, Calif.

In the February issue of RADIO BROADCAST your article "A Knock-Out Three-Tube Set" was of considerable interest to myself and many others in this vicinity. It is truly a remarkable circuit, this one-tube reflex, and as it becomes better known, I predict for it a popularity never enjoyed by any other hook-up, barring none.

J. Raymond Sharp, Sec'y,  
Philadelphia Paper Box Mfrs. Ass'n,  
Drexel Bldg.,  
Philadelphia, Pa.

Your printed article on a one-tube set that's knock-out is a fine specimen of a radio receiving set. It is easy tuning, quiet and clear as a bell. It is a peach. I made one from magazine directions over a month ago and have received such stations as KDKA and WTAM and all local stations on the horn. For distance Dallas, Texas, Hastings, Nebr., and Davenport, Ia., are good for one tube. Some set!

Albert E. Hawkins,  
27 Russell St.,  
Everett, Mass.

Have made up many circuits but never felt like writing in about them until now. The one-tube reflex, page 13, November BROADCAST certainly is good. I'm within 100 miles of the extreme southwest corner of the U. S. and within an hour after soldering up had KLX, KPO, KGW, WFAA, WOAW, and KDKA, the last named loud and clear enough to get every word. Los Angeles stations 150 miles away worked a Pathe speaker loud enough to hear in a small room.

W. M. Clark,  
Coachella Valley,  
Coachella, Calif.



*How to Make*

*THE*  
**RADIO  
BROADCAST**

KNOCK-OUT FOUR-TUBE ROBERTS RECEIVER

A Complete Description

*By* JOHN B. BRENNAN  
Technical Editor, RADIO BROADCAST

*With Notes on Additional Experiments with the  
Roberts Non-Radiating Circuit*

PRICE, ONE DOLLAR  
*(with blueprints)*

DOUBLEDAY, PAGE & COMPANY  
Garden City New York



# Radio Broadcast's Knock-Out Tale of a Receiver

INTRODUCTION  
Radio Broadcast's Knock-Out Tale (The Receiver)  
NOTES ON INSTALLING THE ROCKET CIRCUIT  
ADDITIONAL EXPERIMENTS WITH THE ROCKET CIRCUIT  
AN APPENDIX OF THE KNOCK-OUT RECEIVER SERIES

COPYRIGHT, 1924  
DOUBLEDAY, PAGE & COMPANY

Second Printing

*Arthur H. Sinton*



## Table of Contents

	PAGE
INTRODUCTORY NOTE - - - - - Arthur H. Lynch	2
RADIO BROADCAST'S KNOCK-OUT FOUR-TUBE RECEIVER John B. Brennan	3
NOTES ON NEUTRALIZING THE ROBERTS CIRCUIT - - John B. Brennan	11
ADDITIONAL EXPERIMENTS WITH THE ROBERTS CIRCUIT - - The Staff	13
AN ANNOUNCEMENT OF THE KNOCK-OUT RECEIVER SERIES - - -	15

---

### *The Ideal Receiver*

**I**T IS not likely that we will ever be satisfied with any particular type of receiver. As time goes on, and our knowledge of radio circuits increases, long distance reception with simple receiving devices which use small batteries and a very small tube, perhaps will be quite general. However, if we stand by and wait for such a receiver to be developed, we will be cheating ourselves of much enjoyment that may now be had very easily and very cheaply. The receiver described in this booklet and in the blue prints that accompany it, is the greatest receiver for home construction that we have ever seen—and we've seen and operated almost every type made and used during the last twelve years.

Walter Van B. Roberts, who designed the two-tube reflex half of the circuit, is in our estimation, one of America's most practical radio men. He has a peculiar knack of being able to make practise conform to his theory, rather than make theory conform to a present development. His two-tube receiver is undoubtedly the most notable advance in receivers for home construction since the development of regeneration by Armstrong.

**W**E HEAR an occasional remark from some of the Radio Wise that the Roberts circuit is not new because it is merely tuned radio frequency of the neutralized type, regeneration of the non-radiating type, and common audio amplification by the well known reflex method. This statement is partially true. Roberts does employ all these systems, but he does more than that. He has succeeded in welding them into a unit that is easily controlled, built, and operated. This is the accomplishment we claim for him. The receiver produces startling results.

To this truly remarkable circuit, Mr. Brennan has added a push-pull amplifier. The four-tube receiver thus developed is capable of reproducing extremely loud and clear music and speech. It is easy to operate, capable of bringing in stations over extremely long distances. Added to this, it is highly selective and most economical.

**P**ERHAPS the RADIO BROADCAST Four-Tube Knock-Out Receiver is not the ideal receiver, but we have heard it pull in forty-six stations on a loud speaker with two tubes, using an indoor antenna. On a short antenna, using four tubes in one of the receivers of this model built by Mr. Brennan, we have blasted the diaphragm of a good loud speaker. When we found a speaker which could carry the output of this set, its signals were heard for more than a quarter of a mile. If you know of a receiver capable of any better performance, let us know about it, and it will not be long before you will find it described in the pages of RADIO BROADCAST. Until then, we believe our Four-Tube Knock-Out is, as we said before, the best four-tube receiver for home construction ever produced. It is not merely the best, but it is the best by a very good margin indeed.

*Arthur H. Lynch.*

Editor, RADIO BROADCAST



# Radio Broadcast's Knock-Out Four-Tube Receiver

By JOHN B. BRENNAN

LAST year Walter Van B. Roberts did a considerable amount of independent investigating with various circuits and about the first of this year, evolved the arrangement which has gained unusual popularity as the Roberts circuit. That circuit, as most everyone now seems to know, if we are to judge by the tenor of the enthusiastic correspondence piling into the office daily, is sensitive, selective, uses a minimum of tubes for a long range receiver, and *does not radiate*. The extraordinary efficiency of this set is caused by its use of reflexing, regeneration, and proper tube-neutralization. Mr. Roberts described his set in this magazine for April and May. Two construction articles appeared on the receiver, one by Zeh Bouck telling how the circuit might be used for very short-wave reception, and the other by J. E. Roberts describing a layout with three tubes in our August number. The receiver described here is without doubt the best, for the constructor who is looking for results, that we have ever seen.—THE EDITOR.

**B**Y DEVELOPING his two-tube reflex circuit, Mr. Walter Van B. Roberts has contributed to radio a receiver of inestimable value and importance. The claims for this receiver made by Mr. Roberts have been fully borne out by the many reports from those who have lost no time in building it, as well as by the further research work conducted by RADIO BROADCAST'S laboratory.

Combining the advantageous features of radio- and audio-frequency amplification through reflexing, regeneration, and neutralization, this circuit is particularly desirable since it does not radiate.

However, an attempt is not made here to repeat the theory of the operation of this circuit as given by Mr. Roberts (RADIO BROADCAST, April and May, 1924), but to supply the radio fan with the data sufficient to enable him to construct this receiver with the addition of an efficient push-pull amplifier.

The ordinary amplifier unit will not consistently operate efficiently with this receiver unless special corrective features are incorporated to control the resultant distortion, howling, or overloading.

The push-pull amplifier unit has been found to supply the desired stability, faithfully amplifying over the average audio-frequency range without distortion.

When a signal is applied to the grids of the tubes (Fig. 1) by the inductive relation

of the primary to the secondary, one grid becomes positive while the other is negative. Naturally an alternate push and pull action of the currents flowing between the plates of the tubes through the primary winding of the output transformer takes place. When the current is increasing in one section of the windings and decreasing in the other it would be expected that the resultant current in the secondary would be small. But the natural polarities of the two sections oppose each other, for the B battery current flows through the end leads of the coils out through the center tap. This causes the two currents induced in the secondary to add up, and the maximum current is delivered to the loud speaker as alternating current.

In the ordinary type of amplifier the current in the plate circuit is pulsating "direct current" with the loud speaker winding in series. When a heavy current is passed through this circuit the diaphragm does not readily respond to the minute changes of current intensity.

By inductively coupling a secondary to the primary and removing the loud speaker connections to the secondary terminals (as in the push-pull unit), the pulsating direct current is transformed to a modulated alternating current.

In the push-pull amplifier, we have a primary delivering energy to two tubes through a split secondary, a C battery to supply the proper negative bias to the grids, a split primary delivering the sum of the output of the two tubes



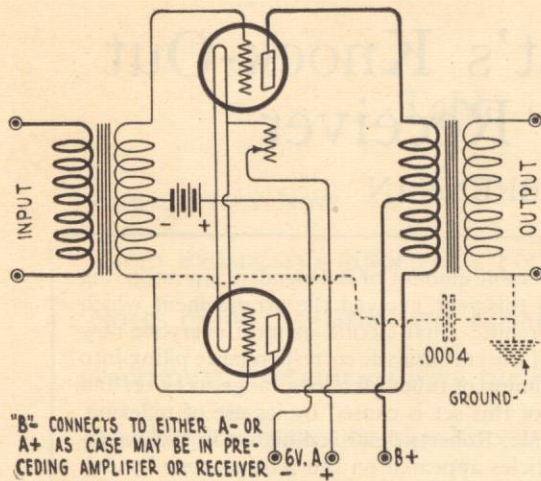

FIG. 1

A standard push-pull amplifier circuit. Usually this unit is used as a second stage but with the Roberts circuit the first audio stage is reflexed and its output passed into the circuit shown here. Exceptional volume and tone quality result

in pulsating direct current, and the secondary delivering alternating current to the loudspeaker. Each one of these features helps in its own way to prevent the possibilities of distortion and overloading.

The value of the C battery varies with the value of the B battery used as the following table shows:

B BATTERY—VOLTAGE—	C BATTERY
80 . . . . .	3.0 to 4.5
100 . . . . .	4.5 to 6.0
120 . . . . .	6.0 to 9.0
150 . . . . .	9.0 to 12.0

It follows, that if the ordinary type of amplifier be added to the Roberts Two-Tube receiver, the resultant signal produced will be greatly distorted unless special corrective measures are incorporated in the general layout. Due to the loud speaker volume produced by the Two-Tube set these corrective controls are frequently ineffective because of the subsequent excessive overloading of the extra stage of amplification and the peculiarities of various transformers.

Taking these obstacles into consideration it was evident that some means of effectually surmounting them would have to be provided. After a series of elaborate tests the push-pull type of amplifier proved entirely satisfactory.

Fig. 2 and the several photos show the general appearance and layout of the RADIO BROADCAST Four-Tube receiver.

MATERIALS

The parts used, with the approximate cost, are listed as follows:

1 Panel 7 x 21 x 1/8	\$2.00
1 Base-board	.50
1 Set Turney Coils	8.00
2 Variable Condensers .0005 mfd.	\$2.50 ea. 5.00
3 Vernier Dials, \$2.00 ea.	6.00
1 Switch Arm	.25
7 Switch Points	.10
2 Switch Stops	.05
4 Sockets, \$1.00 ea.	4.00
1 Transformer (ratio approximately 5-1)	7.00
2 Push-Pull Transformers (set)	12.50
3 Rheostats, \$1.00 ea.	3.00
2 Jacks (Open and double circuit)	1.25

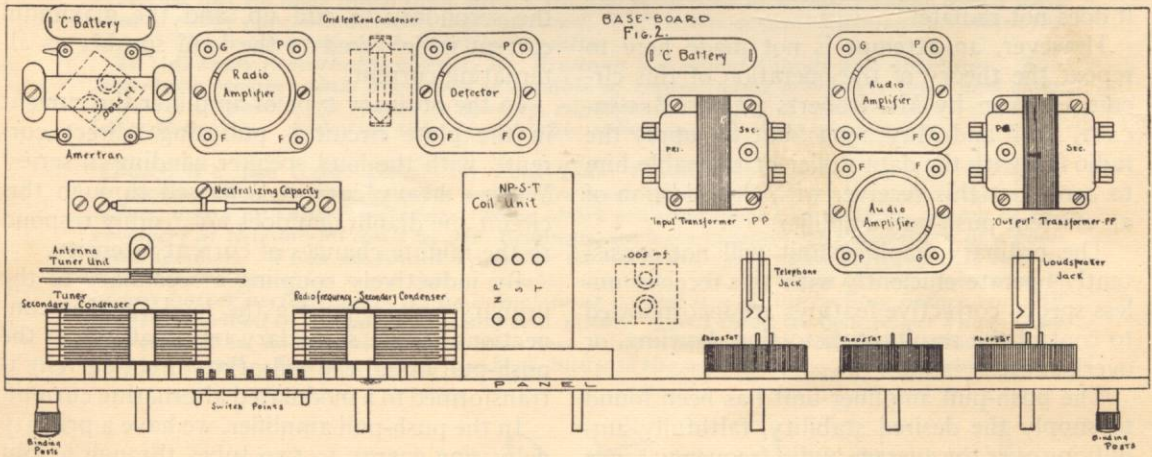

FIG. 2

This base layout shows the general placement, spacing, etc., of the units. On account of the difference in size of the various manufactured parts that may be used, no dimensions are given, which allows the constructor to use his own judgment. Room enough has been allowed for all types of apparatus designed for the functions necessary as units in this circuit.



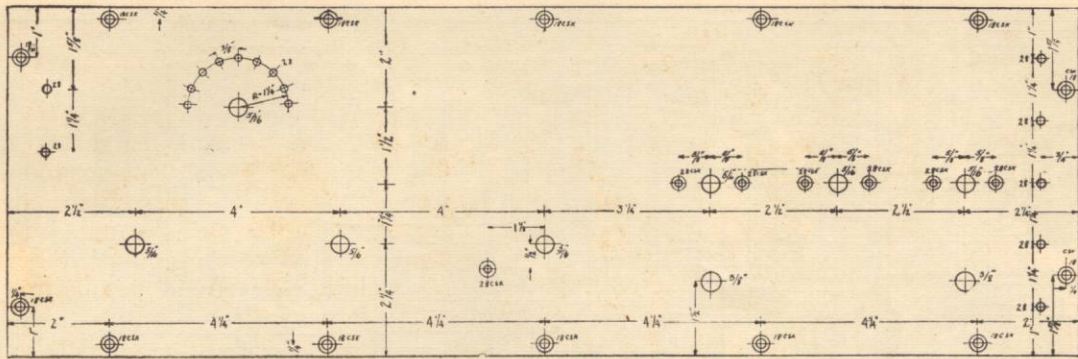

FIG. 3

The panel layout shows the mounting holes on the panel on a small scale, the actual location with dimensions

7 Binding Posts	\$.20 ea.	1.40
1 Neutralizing Condenser		1.50
1 Grid Leak (3 to 7 megohms)		.60
1 Grid Condenser .00025 mfd.		.40
2 Micadons .005 and .0025 mfd.	\$.40 ea.	.80
2 C Batteries 4½ volts	\$.40 ea.	.80
—Miscellaneous bus wire—spaghetti—screws—bolts—nuts—lugs, etc		2.00
Total		\$57.15

flush with the bakelite base. This is shown in Fig. 6. The dial control for this coil is discarded and the separation between the NP and S coils is maintained by the bolt and nut as shown. The coupling between these coils is varied to the correct value by means of this screw and is quite sharp in adjustment, effecting the tone quality and quantity to a marked degree.

The prices given here are high enough to admit of the purchase of parts of good quality.

PREPARATION OF PARTS

**I**N PREPARING the various parts for assembly, the tri-coil unit, and the neutralizing condenser require alterations.

That part of the wooden section of the coil mounting protruding at the left (looking at it from the front) and containing the bearing for the shaft of the NP coil control is sawed off

The neutralizing condenser must be taken apart and the two lengths of bus wire replaced with one continuous piece. Great care must be exercised in performing this operation so as not to break the glass insulating tubing. If, however, the tubing is broken, a length of spaghetti tubing will serve as a substitute.

Tighten all the bolts and nuts on the sockets to insure a positive contact. This is done by first removing the round knurled thumb-nut and tightening the nut and bolt with screw driver and pliers. In doing this be sure that

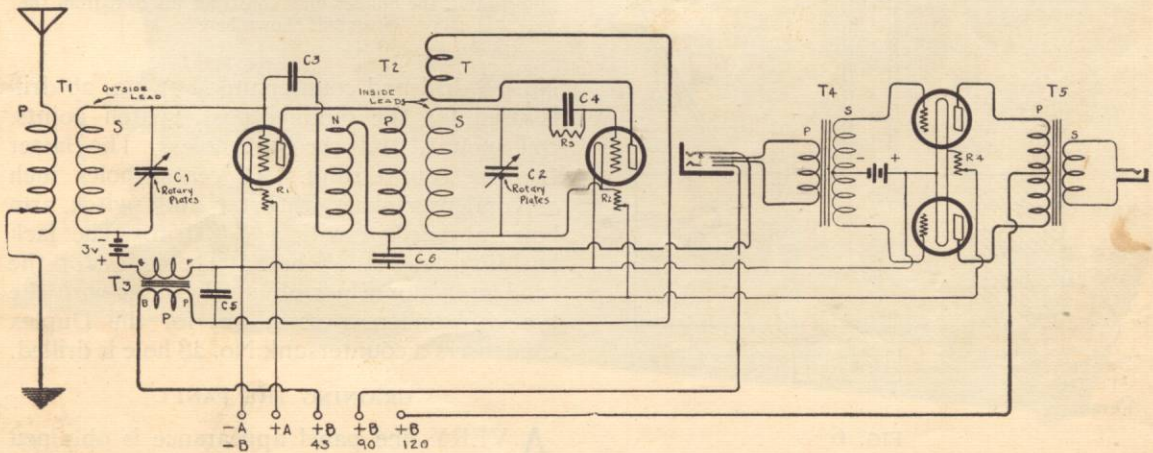

FIG. 4

In this schematic circuit diagram the original Roberts circuit may easily be identified and the push-pull amplifier is also strikingly evident. The left-hand jack forms the dividing line



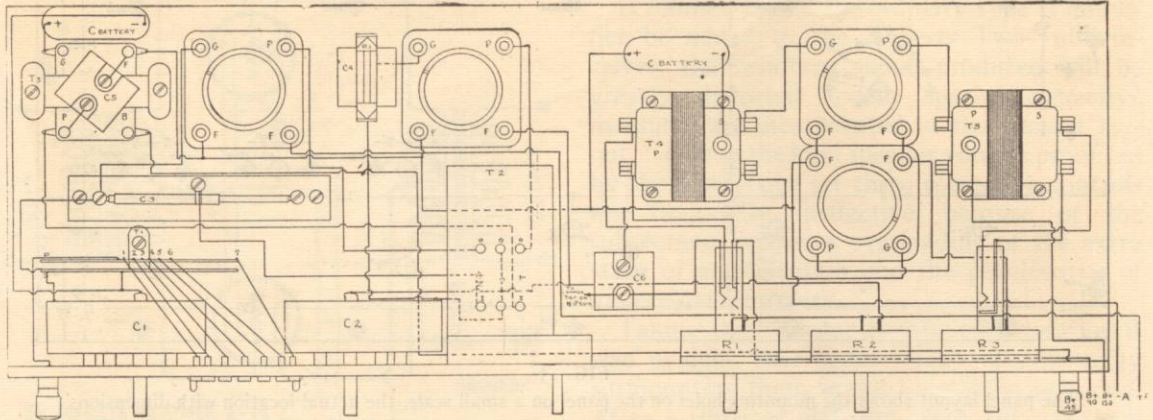

FIG. 5

Shows the actual wiring diagram of the receiver as applied to the base layout shown in Fig. 2. In wiring the set it is advisable to make frequent references to Figs. 4, 5 and 8

the contact blade of the socket does not move out of place.

Lugs are placed at all connection points wherever possible.

#### DRILLING THE PANEL

**T**O PREPARE the panel for drilling, lay out the various center points by direct reference to Fig. 3. With a light hammer and centerpunch mark these points and after securing the panel substantially, drill all the holes first with a No. 28 drill. Once drilled,

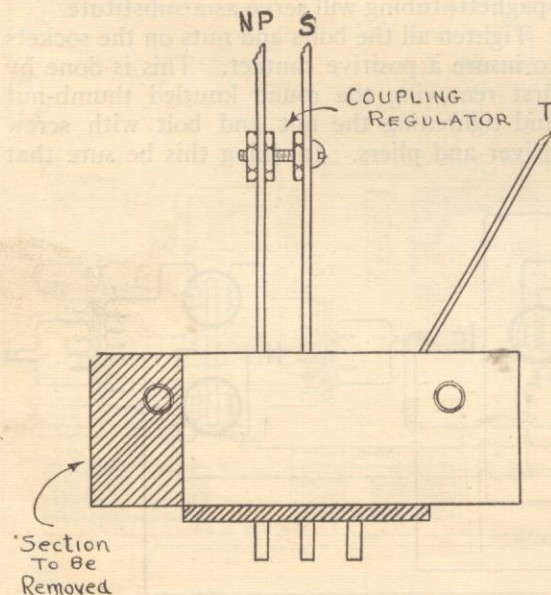

FIG. 6

The alterations of the 3-coil mounting are clearly indicated. The manufacturer of this type of coil has since produced a unit in which similar features have been permanently included. As may be seen by referring to Fig. 9

the holes may be enlarged to their proper size. All the holes for mounting the parts on the panel should be countersunk.

The screw holes around the edge of the panel for fastening it to the cabinet are drilled with a

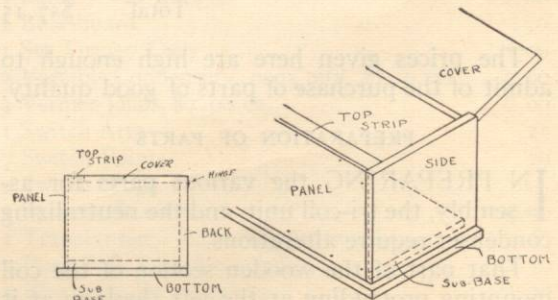

FIG. 7

Although there are many cabinets of standard panel size procurable, the builder may construct his own from the details shown here

No. 18 drill and countersunk. A No. 28 drill is used for the binding post, switch points, coil mount, and rheostat holes. The latter two are countersunk. All center holes such as condenser shaft, rheostat and switch arm holes are drilled with a  $\frac{5}{16}$ " drill. The jack bushings take a  $\frac{3}{8}$ " hole. The holes for the condenser mountings obviously differ with the type of condenser used, but for the Duplex condensers a countersunk No. 28 hole is drilled.

#### GRAINING THE PANEL

**A**VERY fine panel appearance is obtained by adopting the commercial practice of graining. Firmly fix the panel on a bench or table and with a sheet of No. 00 emery cloth



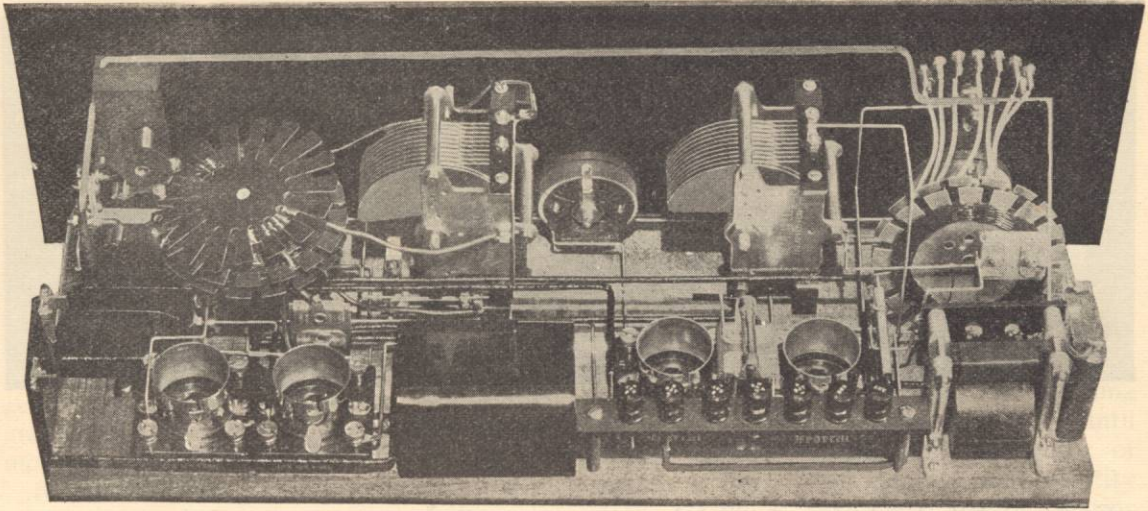

FIG. 9

Another view showing more compact placement and construction, where a standard panel and cabinet have been used. A good job, well done, by the Radio Research Laboratories

wrapped around a block of wood, rub down the panel, removing all the "high lights." The direction of graining is parallel with the long side rather than with the width of the panel.

When all surface marks have been removed, a few drops of machine oil may be rubbed in by the same graining process. A finely grained, highly finished panel surface results.

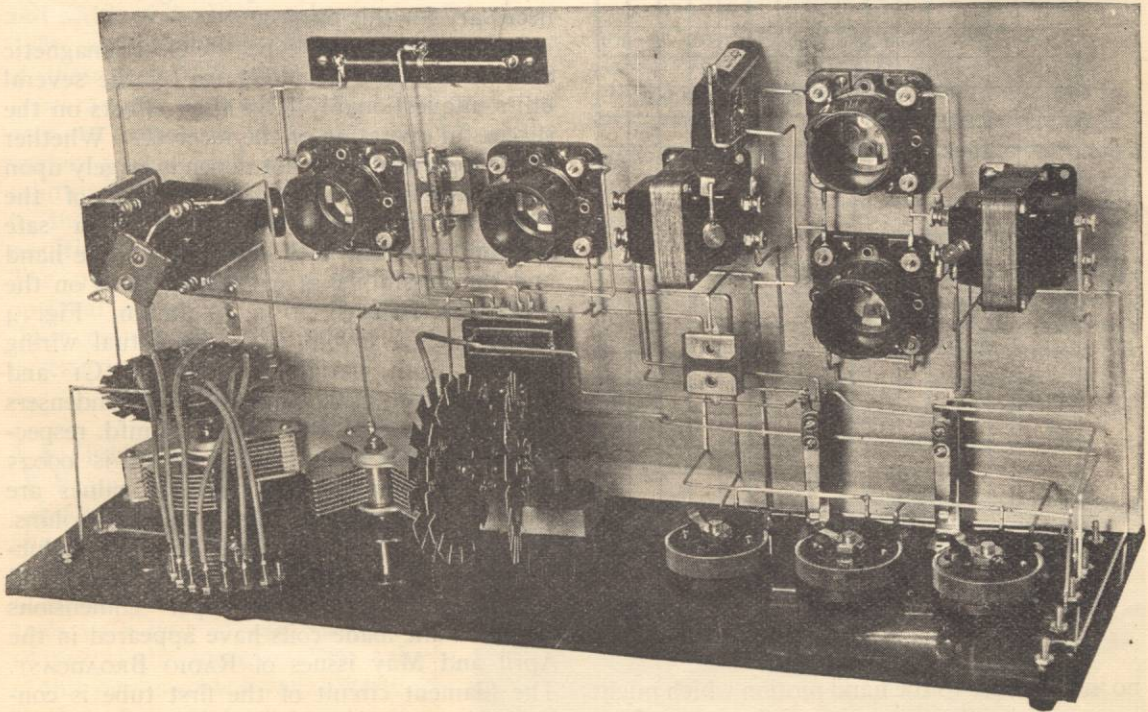

FIG. 8

A base of our test set photographed in RADIO BROADCAST's laboratory. In this receiver generous spacing of the parts is the distinguishing feature. An arrangement of this kind is simple to wire, but it will not fit in a standard cabinet



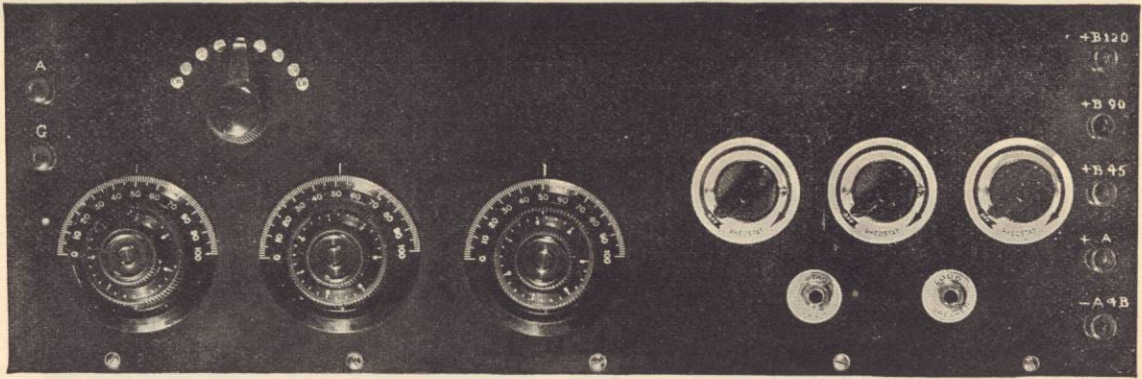

FIG. 10

The panel view of the set shown in Fig. 8. The vernier dials greatly facilitate sharp tuning

Countersink the heads of screws slightly under the surface of the panel so that they will offer no obstruction to the turning of dials or knobs.

#### ASSEMBLY

THE next operation is in assembling the parts upon the panel. The switch points, stops, and arm are first mounted so that there is

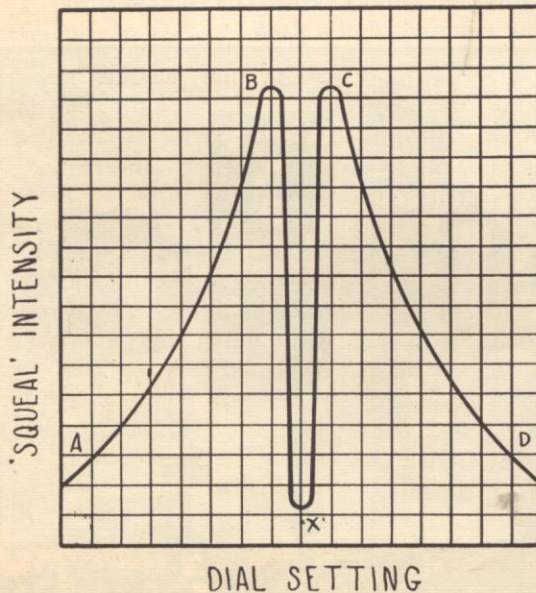

FIG. 11

Graphically explains the system and theory of proper neutralization in the Roberts Circuit

no interference to the hand motion which might be caused by the proximity of the other units. Before mounting the remainder of the units, attach the panel to the base. This supports the panel in a rigid manner facilitating the

assembling of the condensers, tri-coil unit, jacks, rheostats and binding posts in the order named.

The base layout is shown in detail in Fig. 2. It will be noticed that no dimensions are given. This allows the use of other types of apparatus with the same layout scheme. Round head wood screws,  $\frac{1}{2}$ " No. 5 are used to fasten the parts to the base. Where the base of the sockets is thicker than  $\frac{1}{4}$ ", longer screws are necessary for this purpose.

In a receiver of this type, the electromagnetic and electrostatic fields set up by the several units unquestionably have their effects on the successful operation of the receiver. Whether this is detrimental or not depends largely upon the crowding or generous spacing of the various parts. Naturally there is a safe medium at which both crowding on one hand and the possibility of extra long leads on the other are reduced to a minimum. Fig. 4 shows such a layout with the actual wiring circuit. Both variable condensers C1 and C2 are of .0005 mfd., while the fixed condensers C5 and C6 are of .005 and .0025 mfd. respectively. The grid leak condenser C4 is .00025 mfd. For the grid leak, several values are recommended ranging from 3 to 7 megohms. C3 is the neutralizing capacity. The inductances are of the standard Roberts design and are of the manufactured type. Dimensions for the home-made coils have appeared in the April and May issues of RADIO BROADCAST. The filament circuit of the first tube is controlled by a 20 ohm rheostat as is the detector. The two push-pull amplifier tubes have their filaments in parallel with a 15 ohm rheostat in series with the supply.



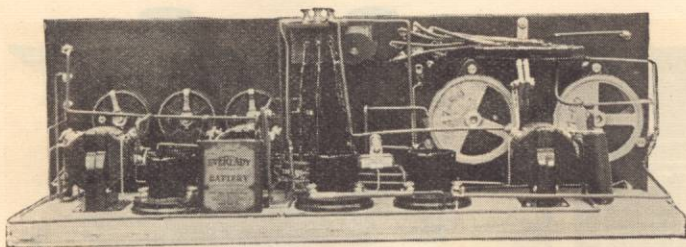

FIG. 12

A rear view of another Roberts experimental model

The photograph Fig. 8 shows the first laboratory model built and strongly indicates the generous spacing of the elements. The photograph Fig. 9 is a revised layout showing the more compact construction.

In following the panel template of Fig. 3 it will be noted that the position of the jacks is slightly altered so that the socket may be brought nearer to the panel.

#### WIRING THE SET

THE actual wiring of the receiver is shown in Fig. 5. The schematic circuit is shown in Fig. 4. Together with the base photos these wiring layouts clearly indicate the attempt to keep the wires short, parallel to the length and width of the base, and to make all turns at right angles to each other. The observance of these few rules add to the workmanlike appearance of the finished job. Soldered connections were made to the lugs attached to the various parts. Half and half strip solder and a solution of resin mixed with Carbona or alcohol to the desired liquid consistency, was used, resulting in a clean, permanent connection. The use of spaghetti insulating tubing is optional excepting where there is danger of short circuiting, then its use is absolutely necessary.

#### OPERATING NOTES

WE USED UV-201-A tubes throughout, but any standard tube may be substituted providing the necessary changes in value of the filament rheostats are made. The grid leak resistance of the detector tube controls to a large degree the volume output of the receiver. The value of this resistance will vary according to the tube used, from about 2 to 7 megohms.

If all the batteries etc., have been connected and the set is otherwise

ready to operate, the following procedure of tuning is followed. Turn the tubes on to normal brilliancy and listen-in on the first jack. Turn up the tickler control so that the coupling between the secondary and the tickler is quite close. Now, set the tap switch on the middle point and simultaneously rotate the two condenser dials slowly.

Gradually the squeal of a station will be tuned-in until it reaches its loudest point. Let these controls remain at this setting and then slowly reduce the coupling between the tickler and the secondary until all the squeal vanishes and the music or speech is clear. The quality and quantity of the reception can be increased by clearing up the tuning with a further adjustment of the rheostats and the switch taps.

The operation of the push-pull amplifier is entirely controlled by its filament rheostat. It is important to observe that a loud speaker be used that is capable of handling the large output volume without distorting the tone quality. Signals from this receiver are so loud that some loud-speakers can not carry them when the set is turned on full. Undue oscillation or howling that seemingly cannot be controlled by any of the tuning units may be eliminated (providing the correct connections to the coils have been made) by reversing the leads to the primary of the audio-frequency transformer used for reflexing. It is also necessary to vary the detector B voltage to its proper value, depending upon the individual tube used.

Fig. 12 shows how the tuning squeal would appear if visualized. When the cylindrical tubing on the neutralizing condenser has been adjusted so that at a certain point on the dial of the first condenser there is a comparatively quiet spot a few parts of a degree either side of this point, but gradually and equally in-

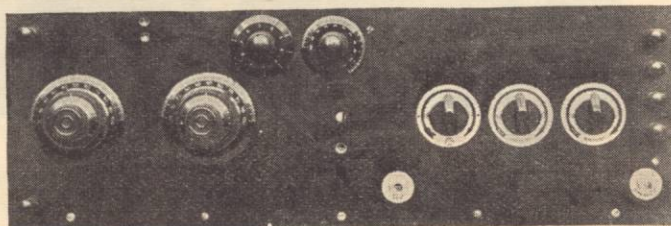

FIG. 13

A panel view of Fig. 12. A manufactured inductance switch, shown at the left-top has replaced the ordinary switch arm and contact points



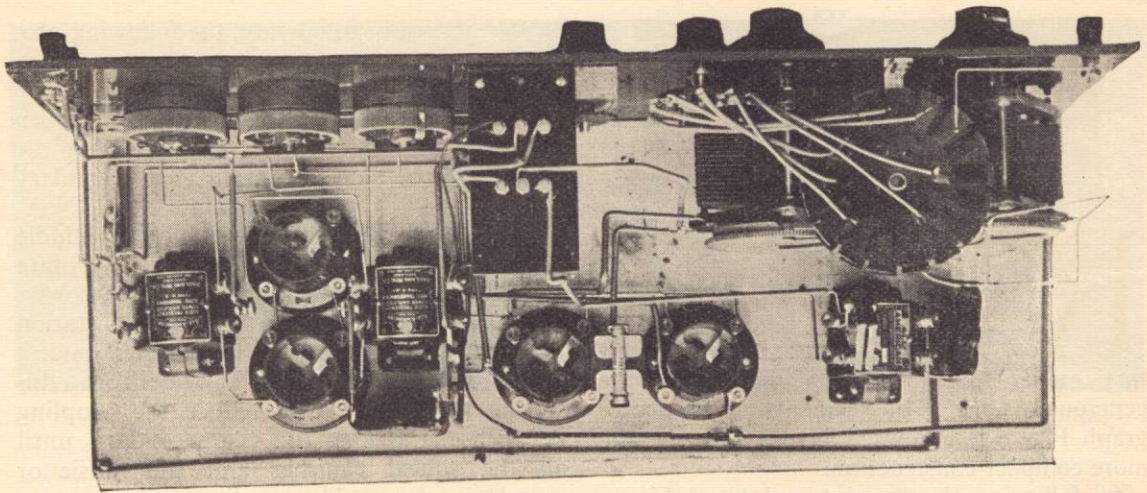

FIG. 14

Another base view. Other parts and a different base and panel layout prove the wide flexibility of design

creasing then decreasing in a whistle as the dial approaches and passes this point, it may be assumed that the correct location of the tube has been determined. But, if it so happens that the squeal first increases gradually, then quickly slumps down, then quickly increases and quickly decreases, it is evident that the proper balance has not been obtained. Try sliding the tube in the opposite direction of its original position for only a short distance and repeat the variation of squeal intensity. In Fig. 12, X shows the silent point extending from B to C, while A-B indicates a gradual

increase in intensity and C-D indicates a gradual decrease in squeal intensity. This constitutes the proper squeal adjustment.

The tapped primary allows the use of practically any size of antenna. In the RADIO BROADCAST laboratory two hastily constructed antennae were used, both not being more than ten feet in height. One was 18 feet long, the other about 150 feet long. No great difference in volume or in sharpness of tuning was noticeable in the use of either.

The use of vernier dials is a decided aid in the tuning of distant stations.

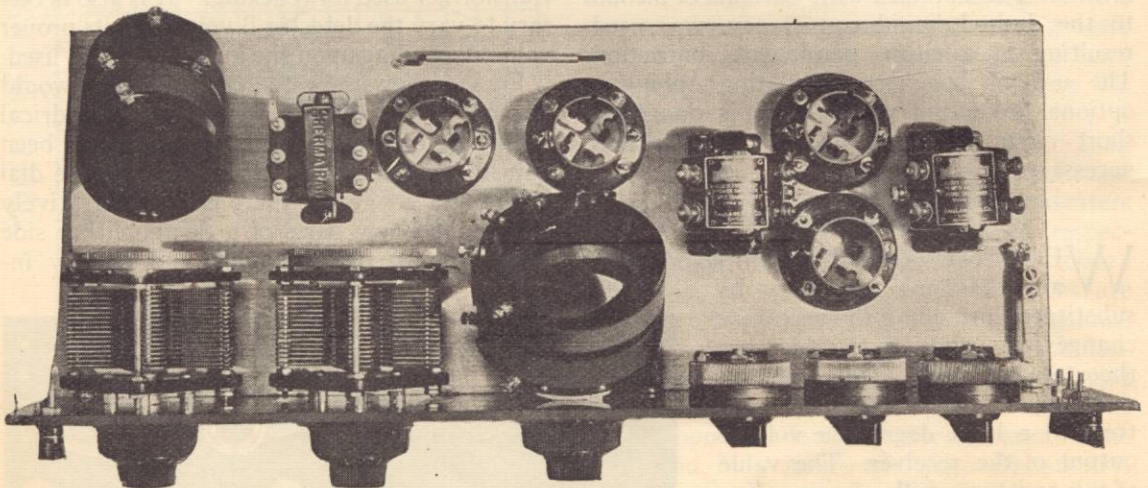

FIG. 15

Adapting the circuit to tuning units of a more standard nature. A 180° coupler is rewound to take the place of the spiderweb NP-S-T coils and the antenna inductance is wound on a cylindrical form mounted at right angles to the coupler. No matter what type of apparatus is used, it is well to make a permanent, complete layout of this character before doing any of the wiring



# Notes on Neutralizing the Roberts Circuit

**R**ADIO receivers, especially those using the regenerative principle, should not be allowed to radiate energy into space, causing unnecessary interference with other receivers in the vicinity.

In the Roberts circuit, radiation is prevented by the use of the coil N and the condenser connected to the grid of the first tube and the coil N. This coil N, because of its peculiar connection, prevents oscillation in the plate circuit of the first tube, and the condenser, when properly adjusted, should exactly equal the capacity between the grid and plate of the tube. (See Fig. 4). Mr. Roberts describes the theory of this action as follows:

Whatever alternating voltage exists on the plate of the tube must be due to alternating magnetic flux linking P. But the same flux also links the similar winding N, which is connected the other way 'round, and hence, acting through C, produces an effect on the grid which is equal and opposite to that produced by P acting through the grid-plate capacity of the tube. Thus the net feed back, or tendency to regenerate is completely neutralized or balanced.

Having now determined the necessity for this neutralization, we must know how to apply this method of neutralization to the receiver.

To do that, one proceeds as follows: turn the tickler control well up against the secondary; light the filaments of the tubes and rotate both dials until the carrier wave or "squeal" of a station is located. Now adjust the dials for maximum signal strength and then lower the tickler coil to loosen the coupling between it and the secondary.

Now, by rotating the left hand dial slowly, the intensity of the squeal will be varied as the dial is moved. The intensity depends on the amount and the direction that the dial is turned.

On the next page are shown two curves, which illustrate incorrect and extremes of unbalanced neutralization which are occasionally experienced in the Roberts circuit. To operate this receiver successfully without radiation, the

neutralizer must be correctly adjusted. Therefore a bit of instruction on this important feature will not be amiss.

The best home-made type of neutralizer is made from a length of bus bar with spaghetti or glass insulation and a piece of copper gasoline tubing for the sliding member. Fig. 1 gives the dimensions for such a unit.

In determining whether or not your receiver is properly neutralized, one must visualize the rise and fall in squeal intensity.

The curves in the two graphs shown in Figs. 2 and 3 are somewhat exaggerated to make it easier to understand the action of the neutralizer.

## HOW TO TEST YOUR SET FOR IMPROPER NEUTRALIZATION

**B**Y ROTATING the dial (Fig. 2) in the direction of the arrow, we find a quiet spot X at the reading 50 and extending one or two degrees either side of it. By continuing slowly to rotate the dial, we immediately reach the full squeal intensity indicated at B. As the dial continues to rotate, the squeal intensity gradually decreases to A. On the other side of X, rotating the dial in the opposite direction, we immediately reach the full squeal intensity as before at C, but here the decrease in intensity is very rapid, ending at D.

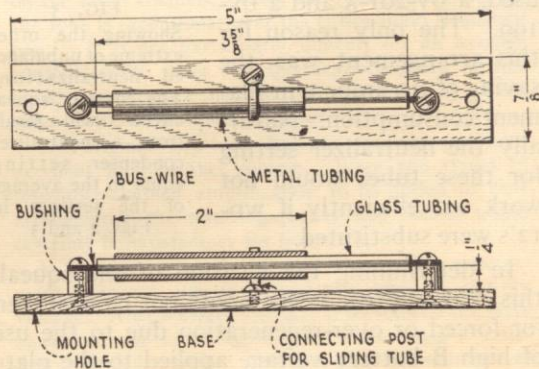

FIG. 1

How to make your own neutralizing condenser. Bakelite or formica may be substituted for the hardwood base. If it is desired, the right side mounting may be eliminated, making it possible to slide the tubing over the end. This will allow a greater range of neutralization



In Fig. 3 the action is just the opposite. The quiet point X is found at 50. Rotating the dial in the direction of the arrow, the full squeal intensity is immediately reached at B and then rapidly decreases to A. On the other side of 50 we immediately reach the full squeal intensity at C which gradually diminishes to D.

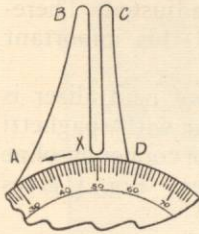

FIG. 2  
An example of extremely unbalanced neutralization. Visualize your own "squeal curve" on condenser C1 in the Roberts circuit

These two examples of improperly balanced neutralization will suggest to the constructor the proper setting of the condenser. The graph showing the proper balanced squeal curve is published on page 8 of this booklet in the article on the four-tube receiver.

Obviously, if your receiver produces squeals similar to those indicated in Figs. 2 or 3, the condenser tubing

must be shifted until each section on either side of the quiet spot (indicated in the graph,) is equal and balanced.

It is well to remember that the same setting will not always be correct for all tubes. *The Roberts receiver will operate equally well with all types of standard tubes.* In the first description of the Roberts circuit appearing in the April 1924, RADIO BROADCAST two types of tubes were used, a UV-201-A and a UV-199. The only reason for this arrangement was the saving of .19 ampere in filament consumption. Naturally the neutralizer setting for these tubes would not work out efficiently if WD-12's were substituted.

In determining the location of the squeal, this characteristic noise should not be mistaken for forced or over-regeneration due to the use of high B battery voltage applied to the plate of the detector tube. However, in this operation, the tickler coil should be turned well up against the secondary. Once the squeal of a station has been located, the volume may be reduced at will by decreasing the coupling between the tickler and secondary coils.

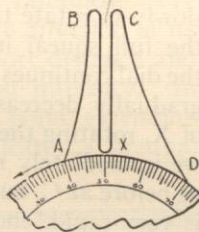

FIG. 3  
Showing the other extreme of unbalanced neutralization. The correct "squeal curve" will result from a neutralizer condenser setting equal to the average of the settings in Figs. 2 and 3

To adjust the regenerative action so that there is no sudden 'plop' of the regenerative squeal, regulate the detector B voltage to its most effective value for the particular detector tube used.

#### ANOTHER GOOD TEST

ONE of our readers, Mr. W. A. Golden, Jr., of Santa Ana, Calif., writes us as follows:

A very easy and effective method of determining the point of neutralization can be had by the use of a good crystal detector and a pair of phones connected across the antenna and ground binding posts. First tune-in a strong station in the regular manner, allowing the detector tube to oscillate and form an audible beat note with the carrier wave of the station; then listen to the phones connected in series with the crystal detector between the antenna and ground and, if the set is not neutralized, this beat note will be heard. Now adjust the small neutralizing condenser until this beat note becomes inaudible. It is a good idea when doing this to listen to the phones in the plate circuit of the tube set once in a while so as to be sure that the detector continues to oscillate and form the audible beat note at all times while the neutralizing condenser is being adjusted. When the beat note can no longer be heard in the phones between the antenna and ground, the set is adjusted properly and should be left permanently in this condition.

I have found this a very simple and efficient means of performing this otherwise rather difficult task.

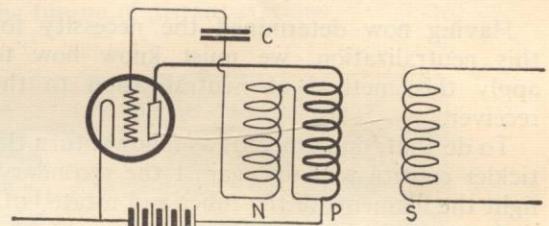

FIG. 4

The heart of the Roberts circuit. Any standard tuned radio-frequency amplifier may be neutralized by using the inductance N and the capacity C. In the Roberts circuit, S is made of 44 turns of No. 22 DCC wire wound on a spiderweb form having 13 teeth. The first turn diameter is  $2\frac{1}{8}$  inches. The outside diameter is 5 inches. S is shunted by a .0005 mfd. variable condenser, preferably a vernier. Coil N-P is wound on a similar form. A pair of wires, of different colors for ease in winding and connection, are wound for 20 turns. For this coil, use No. 26 DCC wire. The outside turn of one of the wires is connected to the plate and its other end (inside) is connected to the outside lead of the other wire. From this point, a lead is brought to the B battery or phones. The inside end of the other coil attaches to the neutralizing condenser C which is connected to the grid of the tube



## Additional Experiments with the Roberts Circuit

**T**HERE is a very large and a very interesting field for experiment both in simplifying and elaborating the Roberts circuit. Experiments and improvements can be tried in both the design and the mechanical layout. Some of the many interested experimenters with this set have been trying cylindrical coils instead of the spiderweb type. Some of the appended photographs illustrate certain types of apparatus which may be considered for trials along this line.

Several other forms of neutralization might be used in this circuit, and those who are familiar with these methods and feel they are competent to experiment with them, might well try the "Rice method," the use of "fixed tickler," and the "untapped primary" each offer interesting possibilities for experiment in simplifying the control of this circuit.

It is not the purpose in suggesting experiment with this circuit to intimate that the builder merely fool idly with various other combinations of instruments, but that he really try intelligently to improve or refine the circuit.

In experimenting with cylindrical coils, start out with the same number of turns as specified for the spiderwebs. Then vary the windings for satisfactory operation.

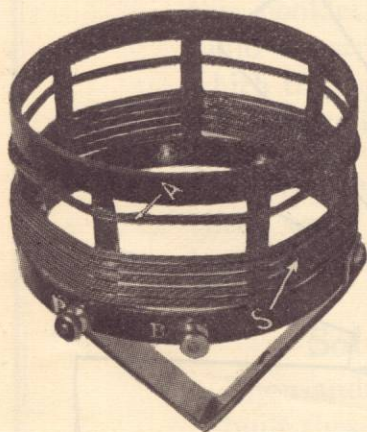

### OTHER POSSIBILITIES

These Bremer-Tully coils can be substituted in the Roberts circuit. Both have bank-wound sectional inductances. The coil at the left has an aperiodic primary and is used as the antenna coupler in the Roberts set. The other can be used as the NP-S-T unit



### POSSIBLE VARIATIONS

**F**OR those who wish a receiver delivering possibly less volume and unquestioned quality at perhaps a more moderate cost than the one described, we heartily recommend the substitution of a two-stage resistance-coupled amplifier instead of the push-pull audio-frequency amplifier. Using only 90 volt plate potential with a  $4\frac{1}{2}$  volt negative bias on the radio frequency tube, the resultant quality of the tone is exceptional over the entire audio frequency band. It is not particularly difficult for an average constructor to alter the specifications given in this booklet and replace the push-pull amplifier with a two-stage resistance-coupled amplifier.

### A FINE CHANCE FOR EXPERIMENT

This coil, much used in regenerative circuits, may be used in the secondary and tickler inductances with few changes for the Roberts circuit. The coil, lettered P must be removed and a double coil (of 20 turns) wound as a pair of parallel wires must be substituted. A 40-turn single coil, tapped at the 20th turn may there be substituted. This gives us three leads; the center one, the B battery-phone lead, one end connects to the plate and the other to the neutralizing capacity. It may be necessary to wind the NP coil directly over the secondary inductance to obtain the desired coupling

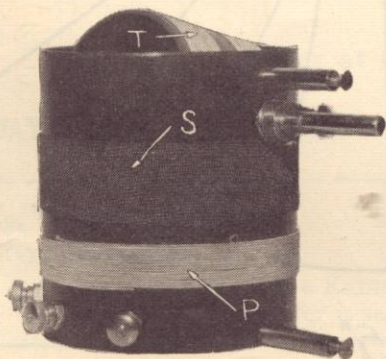

The original two-tube Roberts receiver produced excellent loud speaker volume. Were two stages of resistance-coupled amplification to be added to that arrangement, the resulting quality and volume would certainly be satisfactory for home use.

And contrary to the general belief, this arrangement does not use an abnormally high B battery voltage. Also, we have found that 90 volts on the plate of one of our four-tube Roberts sets using a resistance-coupled amplifier drew less than 10 milliamperes current.

This four-tube receiver has been operated successfully on local, but not far-distant stations, on a loop. As was to be expected in such an arrangement, the tuning was very sharp. It was necessary to change the circuit by substituting a standard two-foot square pancake loop for the first secondary.



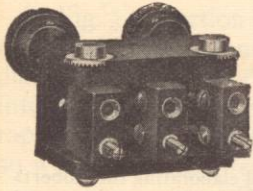

#### THE HONEYCOMB COIL MOUNTING

Can be used for the NP-S-T unit. This arrangement should permit very smooth coupling between the tickler and the secondary and the N-P coil and the secondary. A special two-wire coil may be wound for the NP inductance or a tap may be taken from the electrical center of a 50-turn honeycomb coil to the B battery-phone circuit

#### THE VARIOTRANSFORMER

May be used as an antenna coupler, eliminating the tapped winding. This provides a control on the coupling for maximum resonance between the first primary and secondary circuit. The standard 90° or 180° coupler will also serve in this capacity

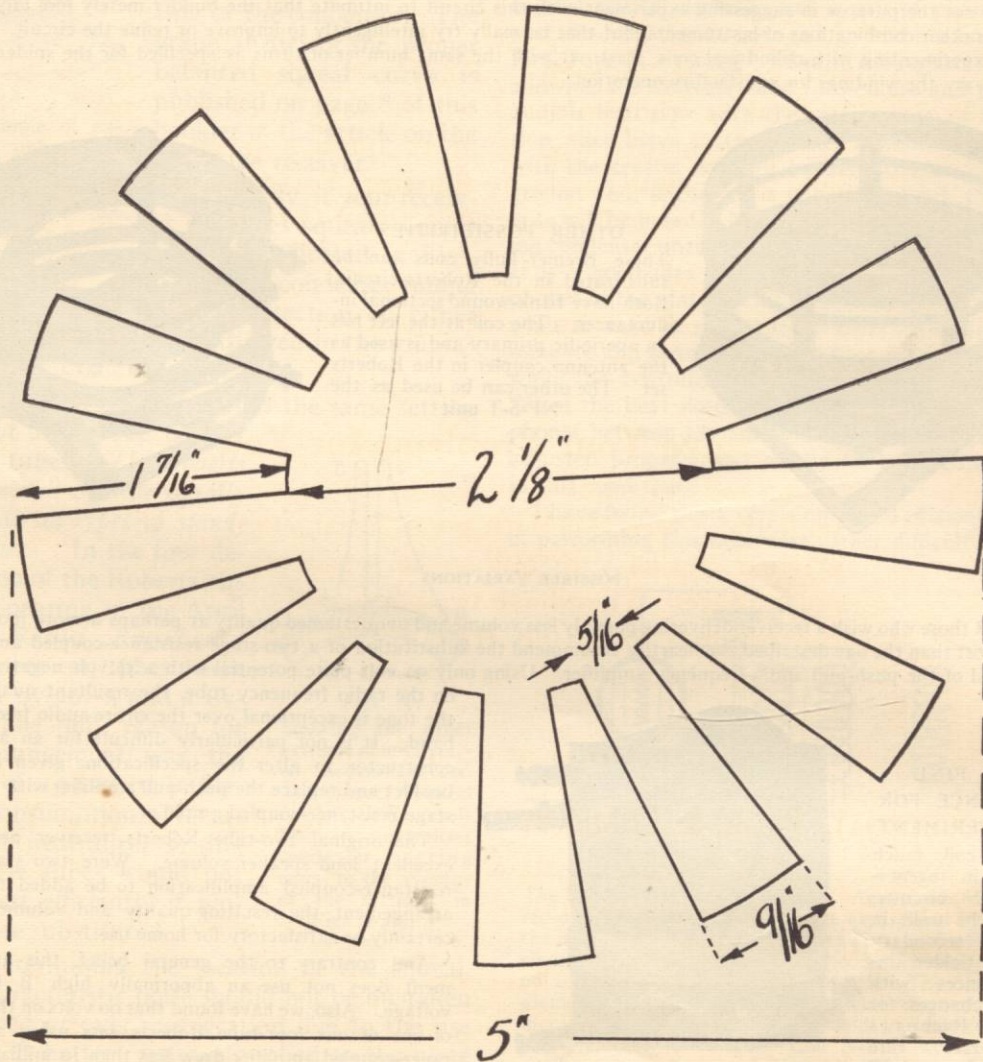
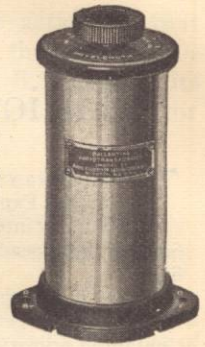

A TEMPLATE FOR THE SPIDER WEB COILS

Exact size. The winding for these coils, as used in various parts of the Roberts circuit and indicated by the letters are as follows: A: 40 turns No. 22 dcc wire tapped 1-2-5-10-20-30-40; S1: 44 turns No. 22 dcc wire; N: 20 turns No. 26 dcc wire; P: 20 turns No. 26 dcc wire (two wires of N and P are wound parallel as a pair); S2: 44 turns No. 22 dcc wire; T: 18 turns No. 22 dcc wire. Coils A, S1, S2 and T are each individually wound under two and over two spokes of the form. The NP coil is wound under one and over one spoke



# A Good Receiver for Every Purse and Purpose

¶ May be found completely described in the RADIO BROADCAST KNOCK-OUT RECEIVER BOOKLET. In this booklet, thousands of which have been sold to radio constructors who want to build a receiver on which they can depend, are illustrated six receivers of the famous RADIO BROADCAST KNOCK-OUT series.

¶ If you want a simple, efficient, and comparatively cheap one-, two-, three-, or four-tube receiver, this booklet will

## Solve Your Problems for You

Thousands of readers of RADIO BROADCAST have built these receivers with great satisfaction. All of them are easy to build, are sensitive, and do not radiate. They have been designed by famous contributors to RADIO BROADCAST, and in their class are the best sets that can be built.

Order at once from

**DOUBLEDAY, PAGE & COMPANY**

**Garden City, New York**

---

**Doubleday, Page & Company**  
**Garden City, New York**

I enclose \$ \_\_\_\_\_ for \_\_\_\_\_ copies of the RADIO BROADCAST KNOCK-OUT RECEIVER BOOKLET at fifty cents a copy. This order is sent with the understanding that if I am not completely satisfied, my money will be returned.

\_\_\_\_\_  
(Name)

\_\_\_\_\_  
(Address)



# Why the "Knock-Out" Articles are Typical of RADIO BROADCAST

THE STANDARD RADIO MAGAZINE

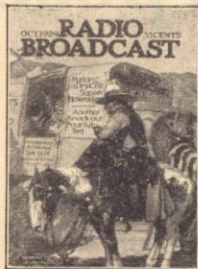

THE "Knock-out" series of How-to-Make-It articles were written originally for and under the direction of RADIO BROADCAST. They give you some slight idea of the practical value of this publication. Every issue contains "How-to-Make-it" articles as well as all manner of practical information and helpful hints. The fact that we receive letters of commendation daily from beginners as well as from radio engineers of many years' standing proves how wide is the scope of this standard radio magazine.

Each issue contains "How-to-Make-it" articles as well as all manner of practical information and helpful hints. The fact that we receive letters of commendation daily from beginners as well as from radio engineers of many years' standing proves how wide is the scope of this standard radio magazine.

## What a Single Issue Gives You!

In every number of RADIO BROADCAST you will find, in addition to the How-to-Make-It articles: Full-page portraits of well-known radio personalities; new and character sketches of the big men in the field; the March of Radio, detailing the monthly progress of the science at home and in foreign lands; how-to-operate-it articles; true stories of radio adventure or enterprise here and abroad; large, clear photographs of new apparatus with full descriptions of the same, articles on controversial radio topics; special articles for beginners and special articles for the advanced; news of the broadcasting stations; articles telling you what to buy and what not to buy; the "Grid"—a questions and answers department giving free service to subscribers; and our newest feature, "The Listeners' Point of View"—a department of criticism of the musical programs offered by the various broadcasting stations conducted by Jennie Irene Mix, the well-known musical critic.

## Some Important Facts About RADIO BROADCAST

RADIO BROADCAST is just two and a half years old. It has 500,000 readers now. We admit that we started out with a great advantage. The public, knowing the quality of the other seven magazines and the many books published by Doubleday, Page & Co., began to buy RADIO

BROADCAST at once, so we never had the "teething troubles" that most new magazines have to go through.

RADIO BROADCAST is fortunate also in having an enthusiastic staff headed by Arthur H. Lynch, editor-in-chief. Mr. Lynch has been with radio since the beginning and was way up in this field before the public knew aerials from clothes lines. Backed up by a large publishing house of great means, RADIO BROADCAST has always been able to pay for the services of the best writers and to buy the best illustrations that money can buy. The foremost men in the radio industry, the most eminent authorities in the government write for us.

## How Our Testing Laboratories Help You

We have our own long-distance receiving station, and our own Testing Laboratory where new apparatus is carefully tried out by the editor-in-chief and his assistants. John B. Brennan, author of article on the four-tube Knock-Out is the director of the Laboratory. Clear photos of such apparatus together with directions telling how to use it appear in every issue. At our receiving station we clearly heard England in the recent trans-Atlantic tests so widely mentioned in the papers. *These tests were conducted under the auspices of RADIO BROADCAST*, and the magazine will this year conduct the American end of International Radio Week.

## Subscribers' Questions Answered Free of Charge

RADIO BROADCAST answers free, the questions asked by subscribers. Whether you are building a set, operating one, or making changes in your outfit, the radio engineers in our laboratories will help straighten out your complexities. While publishing technical articles for the more advanced students of radio, the magazine has made radio human. Pick up and look through a copy of RADIO BROADCAST, and whether you know much or little about the science, you will find plenty of interesting reading.

## Keeps You Ahead of the Rest

Although it keeps you a lap ahead of the rest, RADIO BROADCAST never publishes any information until every detail has been thoroughly tested and verified in every respect. This makes every statement, every bit of advice in the magazine authoritative and reliable.

## Every Issue Profusely Illustrated SEND IN THE COUPON NOW

### Save 10 Cents on Every Copy

DOUBLEDAY, PAGE & CO.,  
Garden City, N. Y.

Enclosed please find \$1.00 for which kindly send me RADIO BROADCAST for four months. (Regular price, \$1.40)

Name .....

Address .....  
4TKO