

Osram Valves

MADE IN ENGLAND

1936  1937
RADIO SEASON

*Valve Voltmeter
Pg 114*

THE GENERAL ELECTRIC CO LTD ENGLAND

Osram Valves

REGD. TRADE MARK.

MADE IN ENGLAND.

CONTENTS.

(For Index to individual valve types
see page 132)

	Page
2-VOLT BATTERY VALVES	3-21
A.C. MAINS VALVES (Indirectly Heated)	23-59
(Directly Heated)	60-69
UNIVERSAL D.C.-A.C. VALVES AND VALVES FOR CAR RADIO	71-85
RECTIFIERS	87-101
SPECIAL VALVE TYPES	103-119
BARRETTERS AND TUNEON INDICATOR	120-125
SCHEDULE OF TYPES AND PRICE LIST	126-129
PIN CONNECTIONS	130-131
INDEX	132

The OSRAM Valves as listed in this publication are entirely British made at Hammersmith, England, only British materials and labour being employed.

The highest quality materials are used in the manufacture of OSRAM Valves and specialised group production and extensive testing ensure the greatest reliability.

The characteristics, etc., published are those applying at the date of publication of this catalogue and are subject to revision.

The material listed in this publication is offered subject to the Company's terms of business and conditions of sale, as given on pages 2 and 3 of cover.

Prices apply in Great Britain and Northern Ireland.

Manufacturers, Wholesale only

THE GENERAL ELECTRIC CO., LTD.

Head Office: Magnet House, Kingsway, London, W.C.2.

Telephone: TEMple Bar 8000 (90 lines).

Telegrams: Electricity, Westcent, London. Cablegrams: Polyphase, London.

Branches throughout Great Britain and in all the principal markets of the world.

FOREWORD

The contents of this catalogue have been compiled to include all the essential technical data and static characteristic curves of the range of OSRAM VALVES for Broadcast Receiving sets, including valves for Battery sets, A.C. Mains sets, Universal D.C.-A.C. sets, and Power Amplifiers.

In addition data is given relative to certain Special Types suitable for use in high gain microphone amplifiers and industrial apparatus.

This catalogue will therefore be found valuable by Radio Service Engineers and Experimenters.

Designation of Valves.

Every effort is made to simplify the designation of each type of OSRAM Valve, and on *new* types for Broadcast receiving purposes the following code letter has been adopted. The code letter is followed by two or more numerals of no significance except for catalogue purposes.

This coding does not apply in the case of high power amplifying--(the D.A. series) or transmitting valves.

A indicates an experimental type of valve adapted for commercial use, but not essentially for broadcast receivers.

B—indicates Double Triode for Class “B” application.

D indicates a Diode, either of single or double electrode construction ; also used in combination in the case of a multiple valve including diode and amplifying elements.

G indicates gasfilled valve.

GT indicates gasfilled triode or gasfilled relay.

H indicates a High Amplification Factor Triode.

L indicates a Low Impedance Triode.

N indicates an Output Pentode.

P indicates an Output Triode.

Q indicates a Double Pentode for “Q.P.P.” push-pull application.

S indicates a Screen Grid Tetrode.

U indicates a Power Rectifier, either for half or full wave rectification.

V—in conjunction with “S” indicates a Variable Mu Screen Tetrode.

W indicates a variable Mu H.F. Screen Pentode.

X indicates a Frequency Changer.

Z indicates a Straight H.F. Screen Pentode.

In some cases two code letters may be employed to designate two particular features of the type :

e.g., DH—Diode and High Amplification Triode combination valve.

GU—Gasfilled power Rectifier.

It will be appreciated that there are a considerable number of receiving types included in this catalogue not bearing the above nomenclature, these having been introduced before the simplified designation came into operation.

e.g., PX formerly indicated a Power Triode. (PX4, etc.)

PT formerly indicated a Power Pentode. (PT2, etc.)

M formerly indicated an A.C. Mains Valve. (MS4B, etc.)

Technical enquiries relative to the application of OSRAM Valves will receive every consideration by the OSRAM VALVE TECHNICAL DEPARTMENT, General Electric Company, Ltd., Magnet House, Kingsway, W.C.2.



Made in England.

2-VOLT VALVES FOR BATTERY RECEIVERS

A complete range of 2-volt low current valves enables the design of a battery receiver to be made consistent with high efficiency, economical current consumption and absence of microphony.

The types whose characteristics are given in the following pages comprise the following recommendations :

For H.F. Amplification.

With straight characteristic—S23, S24.

With variable mu characteristic—VS24, VS24/K.

For Detector.

Triode—HL2.

Screen Pentode—VP21.

Double Diode Triode—HD22.

As Frequency Changer.

X21.

In I.F. Amplifier.

VP21.

In L.F. Amplifier.

HL2.

L21.

As Loudspeaker Valve.

Triode—LP2, P2.

Pentode—PT2.

Double Pentode (Q.P.P.)—QP21.

Osram Valves

Made in England.



Maximum Dimensions :
Overall length (including pins)
128 m/m.

Diameter of bulb
45 m/m.

TYPE S23 SCREEN GRID AMPLIFYING AND DETECTOR VALVE

(For use with a 2-volt Accumulator).

The OSRAM S23 is a 2-volt screen grid valve designed with characteristics suitable to stable and efficient H.F. amplification and to sensitive detection.

The mutual conductance of 1.1 ma/volt is such as to make the S23 type particularly suitable for sets with two stages of High Frequency which a valve of higher conductance would be difficult to control.

The particular characteristics of the OSRAM S23 are as follow :

- (1) Low working values of anode and screen currents thus effecting an economy in H.T. current consumption.
- (2) Non-microphonic performance due to a special form of anchored and bonded electrode assembly.
- (3) Silent background due to high electrode insulation.
- (4) Small overall dimensions.

CHARACTERISTICS.

Filament Volts	2.0 max.	
Filament Current	0.1 amp.	
	Max.	
Anode Volts	150	120
Screen Volts	70	70
Grid Volts	0 to -1.5	0 to -1.5
(for operation in amplifier)		
Anode Current average	2.8-1.4 m.a.	2.7-1.3 m.a.
Screen Current average	0.7-0.4 m.a.	0.8-0.5 m.a.
Mutual Conductance		1.1 ma/volt
	(at Anode Volts 150	Screen Volts 70
	Grid Volts 0)	
Interelectrode Capacities :-		
Anode-Grid (others earthed)	0.0029	micro-microfarad approx.
Grid-other electrodes	8.25	" " "
Anode-other electrodes	9.0	" " "

For prices see
pages 126-129.

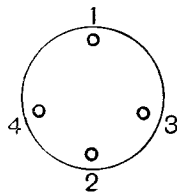

View looking on
underside of base

BASE, 4-PIN.

- Pin 1: Screen
- 2: Grid
- 3: Filament and Metallising
- 4: Filament
- Top Cap: Anode

Type S23 is supplied with clear or metallised bulb, according to requirements.

TYPE S24

Maximum Dimensions :
Overall length (including pins)
130 m/m.

Diameter of bulb 45 m/m.

For prices see
pages 126-129.

The OSRAM S24 is a 2-volt screen grid High Frequency Amplifying Valve with a high value of mutual conductance, or slope. This, combined with a low value of grid-anode leakage capacity makes the valve particularly suitable for 2-volt battery sets in which a considerable magnification is required per stage.

Pin connections as for Type S23.

TYPE S23

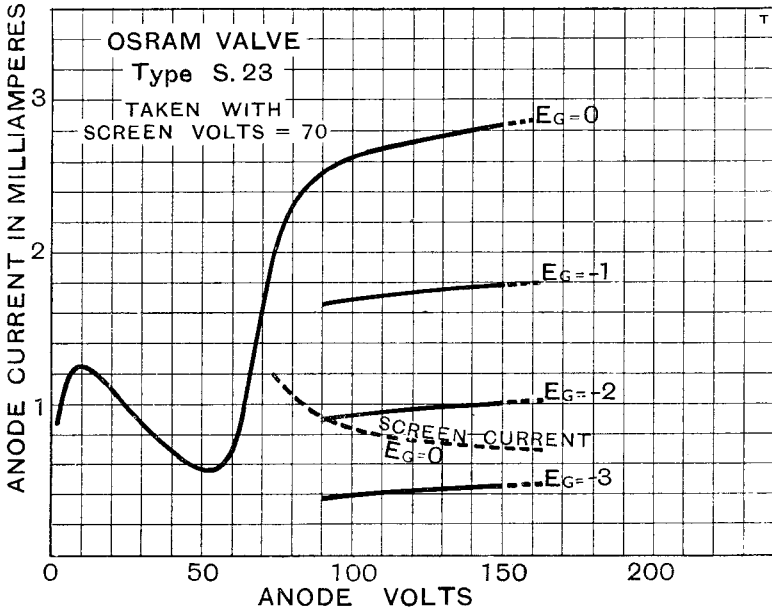

TYPE S24

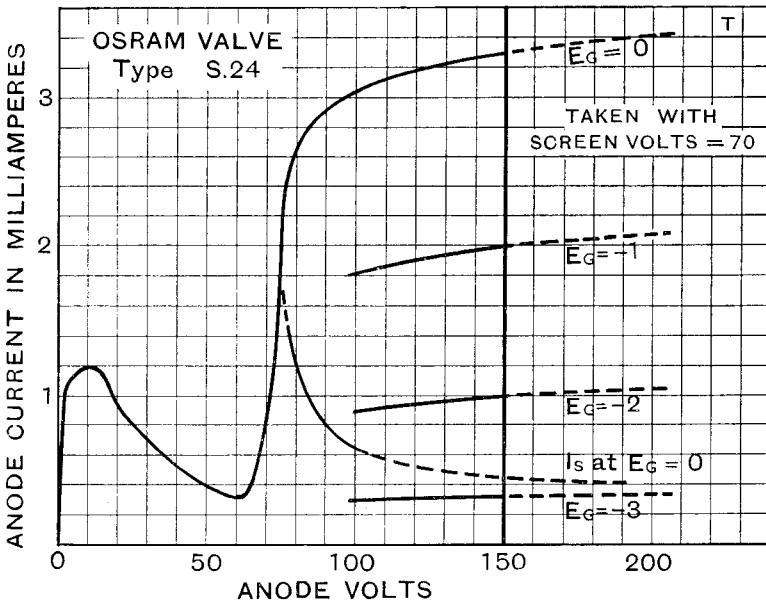

CHARACTERISTIC CURVES OF AVERAGE VALVES

Osram Valves

Made in England.



Maximum Dimensions :
Overall length (including pins)
128 m/m.
Diameter of bulb
45 m/m.

TYPE VS24 “ VARIABLE MU ” SCREEN GRID AMPLIFYING VALVE

(For use with a 2-volt Accumulator).

The OSRAM VS24 is a 2-volt screen grid Valve with characteristics primarily designed to promote easy control of volume in a High Frequency or I.F. Amplifying Circuit by variation of grid bias. The variable grid bias method of volume control lends itself to the reduction of interference known as “cross modulation” so enabling the effective selectivity of the receiver to be increased.

The particular characteristics of the OSRAM VS24 are as follow :

- (1) A high value of maximum mutual conductance giving sensitivity.
- (2) A high value of mutual conductance—grid volt ratio giving effective volume control by means of a grid bias battery not exceeding 9 volts.
- (3) Linearity of control by variation to grid bias minimising the percentage of modulation distortion.
- (4) Non-microphonic performance due to a special form of anchored and bonded electrode assembly.

CHARACTERISTICS.

Filament Volts	2.0 max.
Filament Current	0.15 amp.
Anode Volts	150 max.
Screen Volts	75 max.

At Anode Volts 120—150
Screen Volts 75

Grid Volts	0	-1.5	-6	-9
Anode Current average	4.3 m.a.	2.2 m.a.	0.1 m.a.	—
Screen Current average	0.2 m.a.	0.05 m.a.	—	—
Mutual Conductance	1.5 ma/volt	0.016ma/volt

Interelectrode Capacities :—

Anode-Grid (others earthed)	0.0032 micro-microfarad approx.
Grid—other electrodes	9.2
Anode—other electrodes	8.7

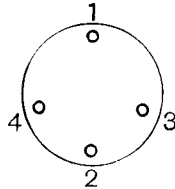

View looking on
underside of base

BASE, 4-PIN.

- Pin 1: Screen
 - 2: Grid
 - 3: Filament and Metallising
 - 4: Filament
- Top Cap: Anode.

For prices see
pages 126-129.

Type VS24 is supplied with clear or metallised bulb, according to requirements.

TYPE VS24/K

Maximum Dimensions :
Overall length (including pins) 118 m/m.

Diameter of bulb 36 m/m.

For prices see
pages 126-129.

The OSRAM VS24/K is a “Variable Mu” Screen Grid Tetrode for use in 2-volt Battery-operated Receivers.

The outstanding feature of the VS24/K is its very small overall dimensions. This makes for considerable economy in space when applied to the design of compact receivers.

Characteristics as type VS24.

Base and pin connections as for type VS24.

TYPE VS24 AND VS24/K

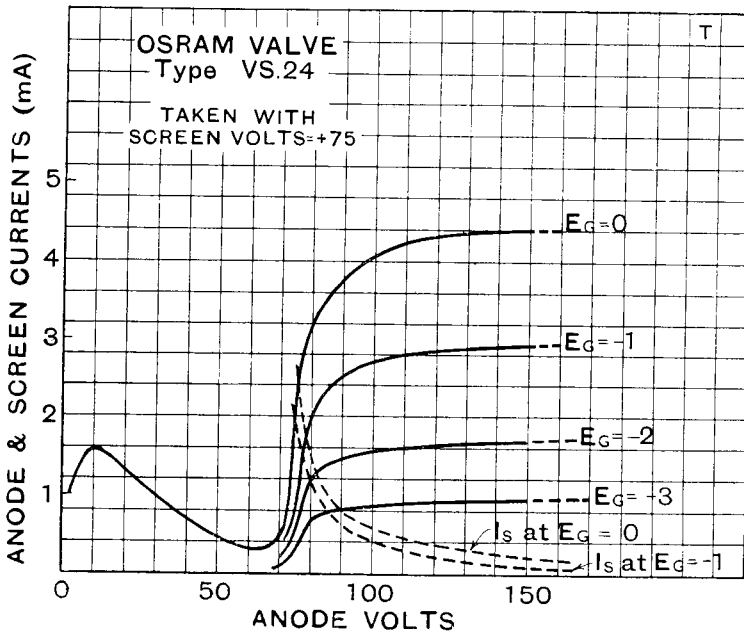
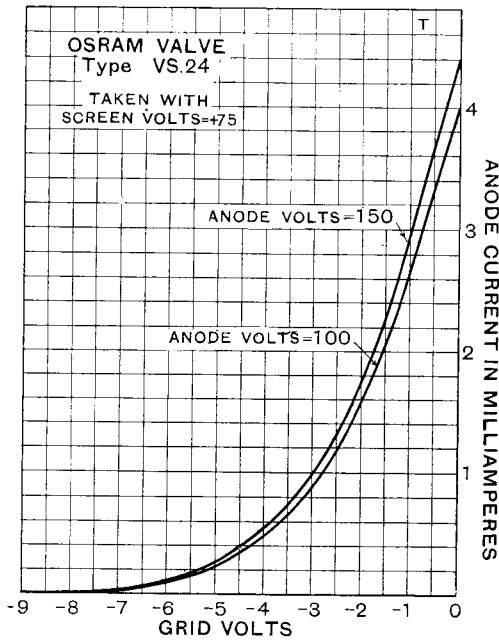

CHARACTERISTIC CURVES OF AVERAGE VALVE.

Osram Valves

Made in England.



TYPE VP21

“ VARIABLE MU ” SCREEN PENTODE
AMPLIFYING AND DETECTOR VALVE

(For use with a 2-volt Accumulator).

The OSRAM VP21 is a 2-volt Pentode primarily suitable for operation as a Detector by virtue of its non-microphonic properties and screen-pentode characteristic.

The VP21 is also suitable for use in an Intermediate frequency Amplifier of a superheterodyne receiver, and as such the “variable mu” characteristic enables volume control to be effected by means of variation to grid bias without introduction of modulation distortion.

Maximum Dimensions :

Overall length (including pins)
128 m/m.

Diameter of bulb 45 m/m.

CHARACTERISTICS

Filament Volts 2.0 max.
Filament Current 0.1 amp.

	Max.	Recommended Operating Conditions.			
		100-150			
		60			
Anode Volts	150	0	-1.5	-6	-9
Screen Volts	60				
Grid Volts					
Anode Current average		2.8 ma	1.5 ma	0.08 ma	—
Screen Current average		0.7 ma	0.38 ma	—	—
Mutual Conductance		1.1 ma/v	0.75 ma/v	0.05 ma/v	0.008 ma/v

Interelectrode Capacities :—

Anode-Grid (others earthed)	0.023 micro-microfarad approx.
Grid—other electrodes	10.6 “ “ “
Anode—other electrodes	6.5 “ “ “

(taken on metallised valve)

For prices see
pages 126-129.

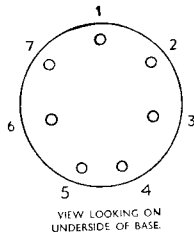

VIEW LOOKING ON
UNDERSIDE OF BASE

BASE, 7-PIN.

- Pin 1 : Metallising.
- 2 : Grid
- 3 : Suppressor Grid
- 4 : Filament
- 5 : Filament
- 6 : —
- 7 : Screen Grid

Top Cap : Anode

Supplied in metallised bulb only.

TYPE VP21

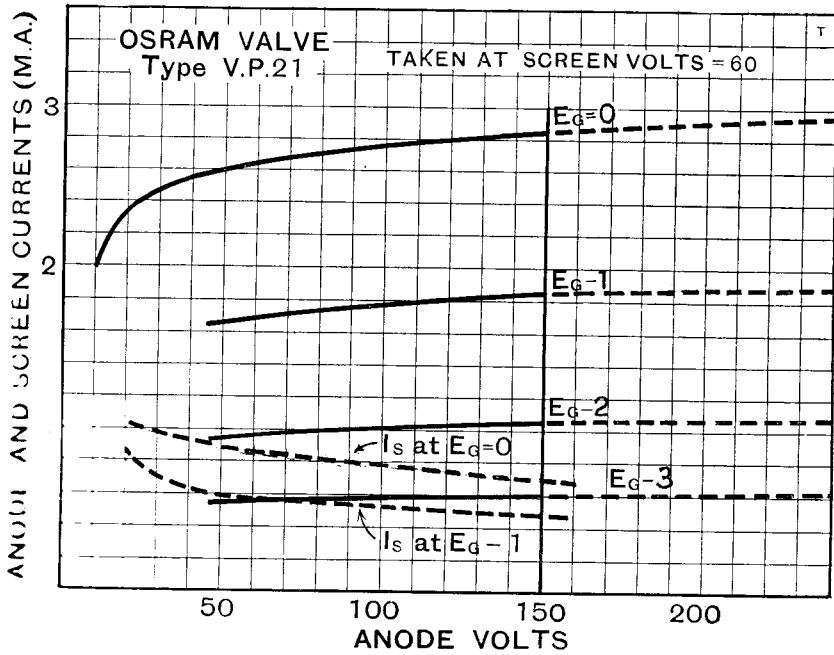
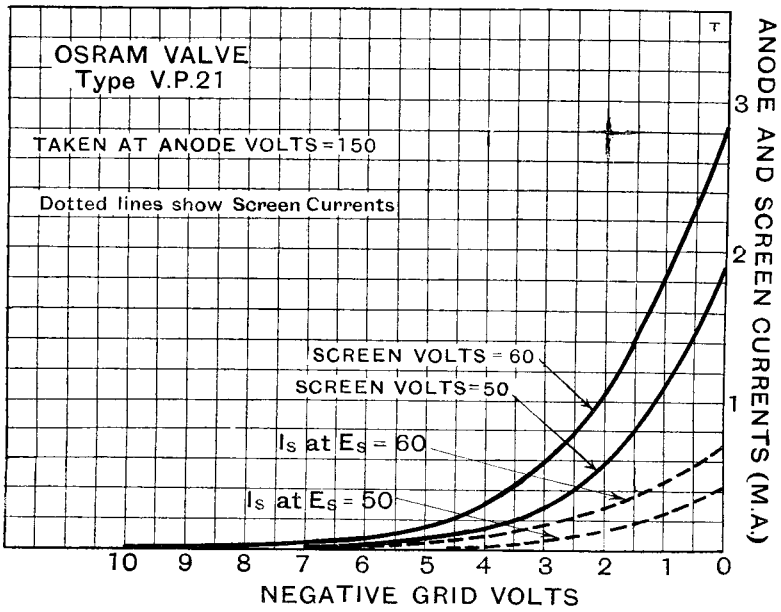

CHARACTERISTIC CURVES OF AVERAGE VALVE.

Osram Valves

Made in England.



Maximum Dimensions :
Overall length (including pins)
130 m/m.
Diameter of bulb 45 m/m.

TYPE X21 HEPTODE FREQUENCY CHANGER (For use with a 2-volt Accumulator).

The OSRAM X21 is a Variable Mu Heptode for use as an electron coupled Frequency Changer in 2-volt battery superheterodyne circuits.

Its advantage is that the oscillator detector coupling is made by the electron stream within the valve itself, no external cathode coupling being required.

It is designed to give a satisfactory conversion conductance, together with a low H.T. current.

Due to the small interaction between the oscillator and mixer sections the OSRAM X21 valve can be used for short wave operation, down to 16 or even 13 metres with suitable precautions.

CHARACTERISTICS.

Filament Volts	2.0 max.
Filament Current	0.1 amp.
		Max.	
Anode Volts	150	100-150
Screen Volts	70	40-50
Oscillator Anode Volts	90	40-50
Oscillator Grid Peak Volts	10	10
Control Grid Volts	0 -9
Total Cathode Current average (medium & long waves)	1.9 m.a.	1.5 m.a.
Conversion Conductance average	240 micromhos	2.0 micromhos
Conversion Impedance	2.0 megohms	
Interelectrode Capacities :			
Control Grid—Anode	0.55 micro-microfarad approx.	
Anode—other electrodes	19.2
Control Grid—other electrodes	11.8
Oscillator Grid—Control Grid	0.153
Oscillator Grid—Oscillator Anode	1.8
Oscillator Grid—other electrodes	7.36
Oscillator Anode—other electrodes	6.85

For prices see
pages 126-129.

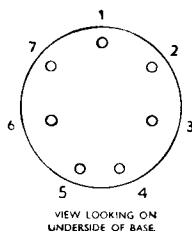

VIEW LOOKING ON
UNDERSIDE OF BASE

BASE, 7-PIN.

- 1 : Oscillator Anode G₂
- 2 : Oscillator Grid G₁
- 3 : Screen Grids G₃ G₅
- 4 : Filament
- 5 : Filament
- 6 : Metalling
- 7 : Anode

Top Cap : Control Grid G₄

Type X21 is supplied with either clear or metallised bulb, according to requirements.

OPERATING CONDITIONS.

For the most satisfactory operation it is recommended that the oscillator anode (G₂) is maintained at a potential of 15 or 20 volts higher than screen grids (G₃ G₅). The screen voltage should be obtained by means of a tapping on the H.T. battery and normally need not exceed 50 volts.

The anode coil should be tightly coupled to the grid coil, and this coupling adjusted until, with a suitable series resistance R₁ (see diagram), a meter in series with the grid leak shows a current between 60 and 100 microamps.

In short wave operation a screen voltage of 40 is recommended and an oscillator anode voltage of 80 to 90 volts.

The oscillator anode current will rise as the wave length is reduced, but in no case should the total cathode current exceed 7.5 m.a.

It is essential for successful short wave operation to reduce to a minimum any coupling between the oscillator and input circuits.

TYPE X21

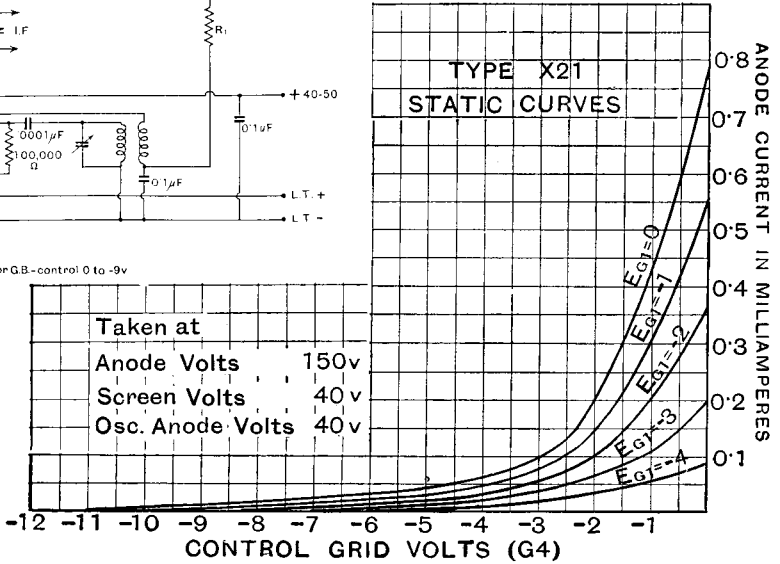
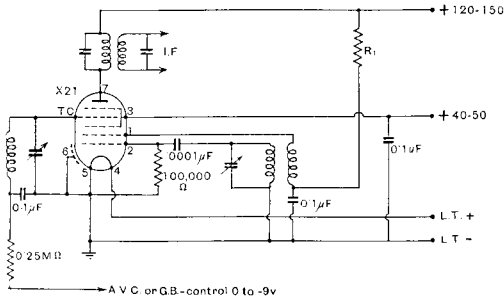

Taken at
 Anode Volts 150v
 Screen Volts 40v
 Osc. Anode Volts 40v

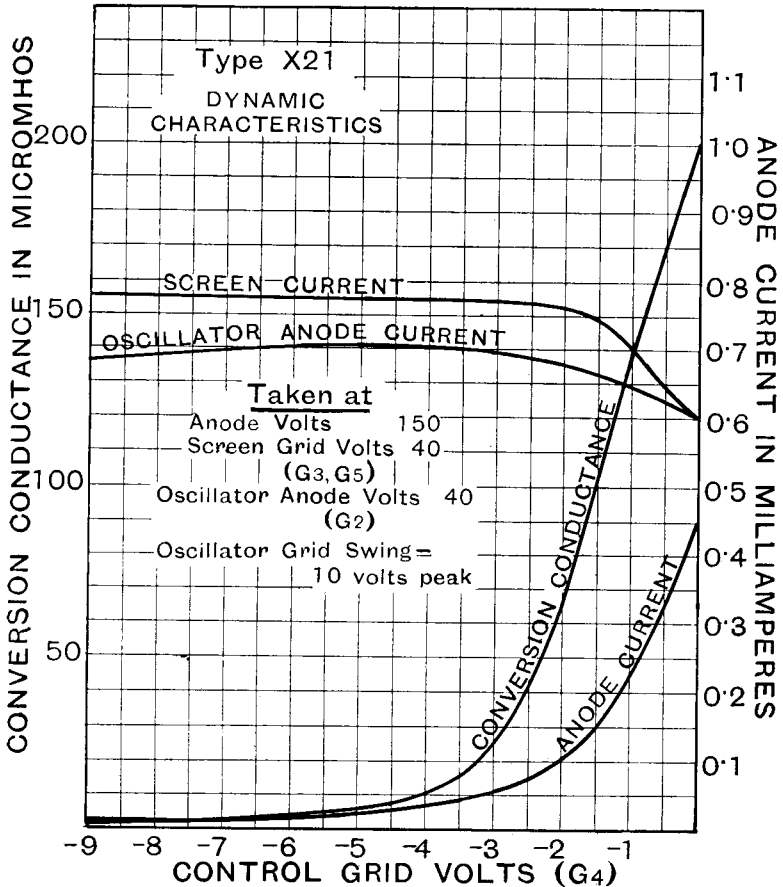

CHARACTERISTIC CURVES OF AVERAGE VALVE.

Osram Valves

Made in England.



TYPE HL2

H.F., DETECTOR, AND L.F. AMPLIFYING TRIODE

(For use with a 2-volt Accumulator).

The OSRAM HL2 is a very efficient dull emitter valve for use with 2 volt accumulators, having a high value of "characteristic slope" or mutual conductance. In addition the HL2 is of extremely rigid construction, with a view to elimination of microphonic noise and acoustic reaction interference. For this reason the valve is strongly recommended as a Detector.

It may also be employed with success in the first stage of a Low Frequency Amplifier, where the relatively low Impedance and high Amplification factor mean good quality reproduction without loss of magnification, or in a High Frequency Amplifier where some form of stabilising or damping is used.

Maximum Dimensions :
Overall length (including pins)
105 m/m.

Diameter of bulb 42 m/m.

CHARACTERISTICS.

Filament Volts	2.0 max.		
Filament Current	0.1 amp.		
Anode Volts	150	125	100
Grid Volts	-3	-1.5	-1.5
(for operation in amplifier)			
Anode Current average	1.75 m.a.	2.3 m.a.	1.25 m.a.
Amplification Factor			27
Impedance			18,000 ohms.
Mutual Conductance			1.5 ma/volt
		measured at Anode Volts 100 Grid Volts 0.	

Interelectrode Capacities :—

Anode—Grid (others earthed)	4.0 micro-microfarad approx.
Grid—other electrodes	8.0
Anode—other electrodes	9.0

For prices see
pages 126-129.

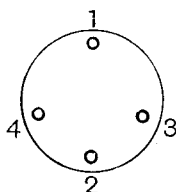

View looking on
underside of base

BASE, 4-PIN.

- Pin 1 : Anode
- 2 : Grid
- 3 : Filament and Metallising
- 4 : Filament

Type HL2 is supplied with clear or metallised bulb, according to requirements.

TYPE L21

Maximum Dimensions :
Overall length (including pins)
105 m/m.

Diameter of bulb 42 m/m.

For prices see
pages 126-129.

The OSRAM L21 is a triode for use with 2-volt accumulators, designed with characteristics specially suitable for efficient low frequency amplification particularly with a view to operation as the "driver" valve for the OSRAM B21 Class "B" Output Valve.

Type L21 may also be employed as a highly efficient oscillator in super heterodyne receivers, or as a Detector valve.

Base and pin connections as for type HL2.

Supplied in clear bulb only.

TYPE HL2

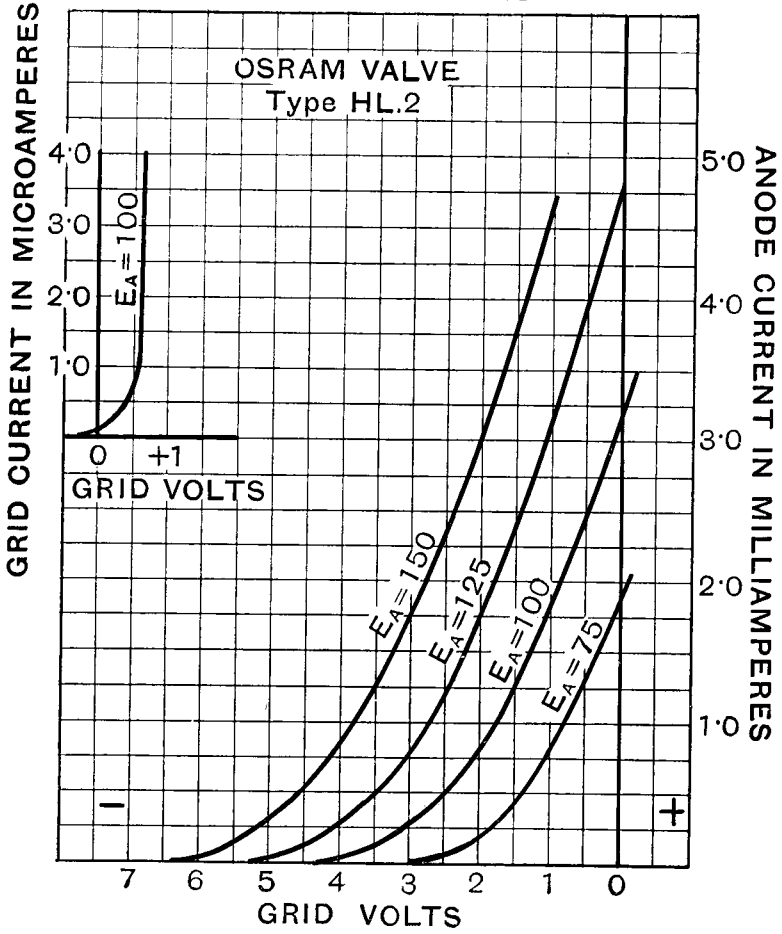

TYPE L21

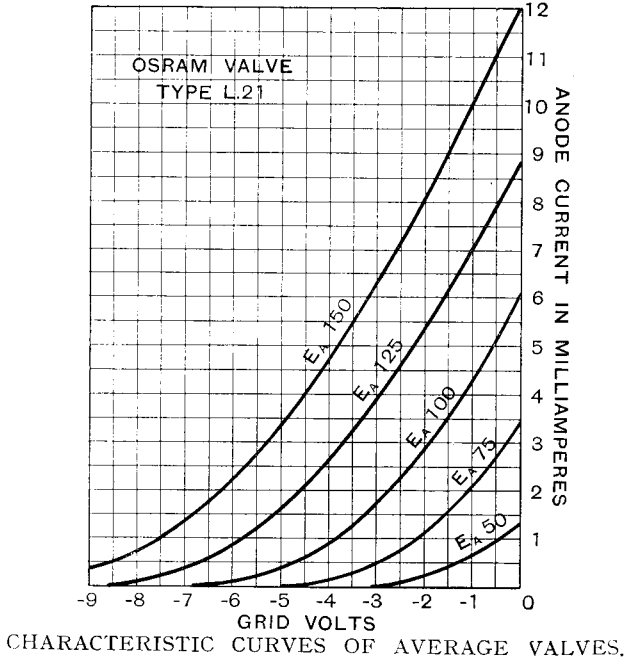

Osram Valves

Made in England.



TYPE HD22

DOUBLE DIODE TRIODE

(For use with a 2-volt Accumulator).

The OSRAM HD22 is a 2-volt valve consisting of triode and double diode electrode assemblies in the one envelope.

In order to obtain maximum efficiency in the triode, a separate filament system from that for the diodes is employed, and the triode is fully shielded from the diode system.

The valve is designed primarily as a detector, and, in addition, affords a convenient and efficient means to effect Automatic Volume Control.

Where Automatic Volume Control is not employed the two diode anodes may be strapped to give half wave rectification.

Maximum Dimensions :
Overall length (including pins) 125 m/m.
Maximum diameter of bulb 45 m/m.

CHARACTERISTICS.

Filament Volts 2.0 max.
Filament Current 0.2 amp.

Triode Characteristics :-

Anode Volts	150	125	100
Grid Volts	-3	-1.5	-1.5
Anode Current average	1.75 ma	2.3 ma	1.25 ma
Amplification Factor	27
Impedance	18,000 ohms 1.5 ma/volt measured at grid volts 0.
Mutual Conductance	

Diode Characteristics.

Diode 1 (connected to pin 5).

	Diode Volts.			
	0.5	1.0	2.0	4.0
Diode Current in Microamps	2	5	15	50

Diode 2 (connected to pin 2).

	Diode Volts.			
	0.5	1.0	2.0	4.0
Diode Current in Microamps	0	1	10	50

For prices see pages 126-129.

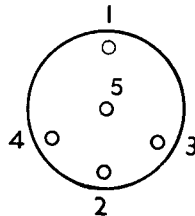

View looking on underside of base.

BASE, 5-PIN.

- Pin 1 : Anode
 - 2 : Diode nearest end of filament connected to No. 4
 - 3 : Filament and Metallising
 - 4 : Filament and Diode Shield
 - 5 : Diode nearest end of filament connected to No. 3
- Top Cap : Grid

Type HD22 has a carbonised bulb and can be supplied metallised if required.

TYPE HD22

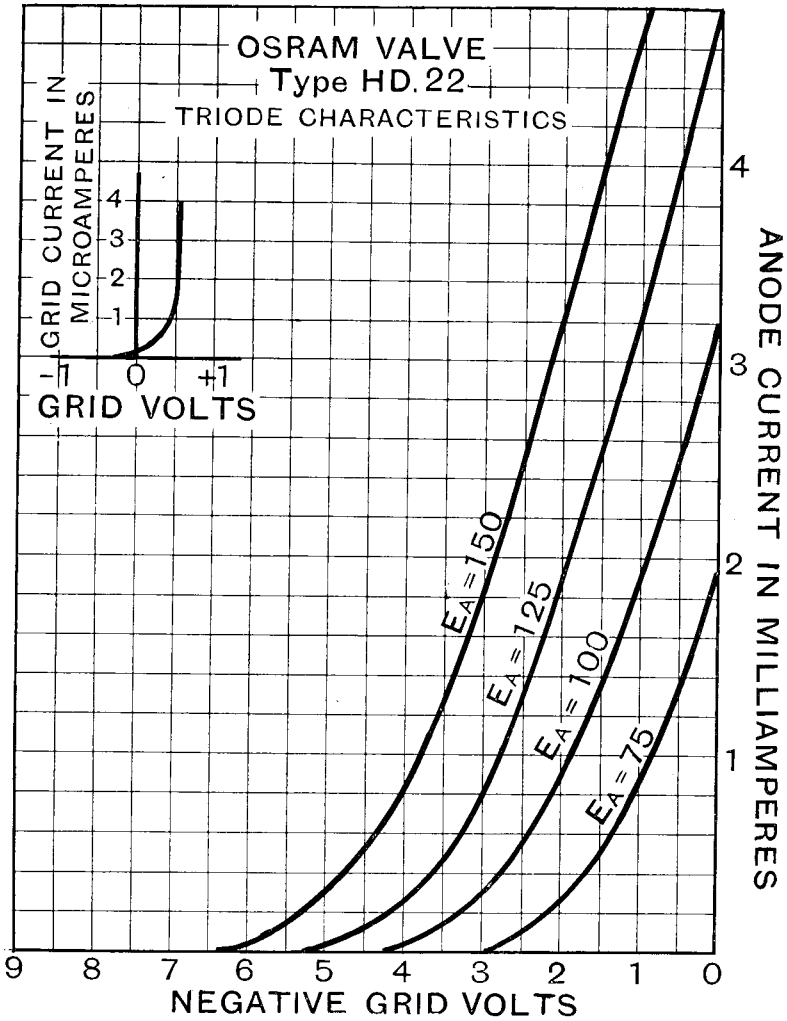
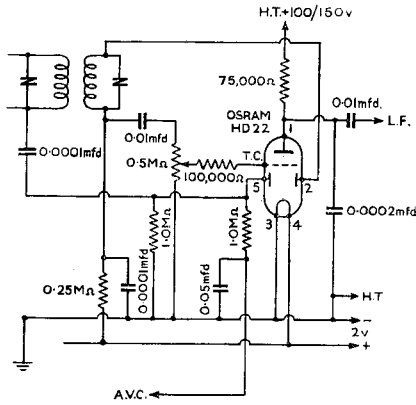

Osram Valves

Made in England.

TYPE LP2

TYPE P2

LOW FREQUENCY AND POWER AMPLIFYING TRIODES

(For use with a 2-Volt Accumulator).



Maximum Dimensions :
Overall length (including pins)
107 m/m.

Diameter of bulb 45 m/m.

The OSRAM LP2 is a Low Frequency and Power Amplifying Valve for use in the last stage of a set operating from a 2-volt accumulator, in cases where a high degree of amplification is desired.

Owing to the high value of amplification factor, the LP2, when employed as an output valve, should be used in simple stage amplifiers only.

The OSRAM P2 is a Low Frequency Power Amplifying Valve for use in the last stage of a set operating from a 2-volt accumulator.

For this purpose it has exceptionally good characteristics, and when used with correct values of anode voltage and negative grid bias will give a distortionless output sufficient for operating loud speakers of the moving coil type.

CHARACTERISTICS.

	Type LP2			Type P2		
Filament Volts ..	2.0 max.			2.0 max.		
Filament Current ..	0.2 amp.			0.2 amp.		
	Max.			Max.		
Anode Volts ..	150	125	100	150	125	100
Grid Volts ..	-6	-4.5	-3	-12.5	-10.5	-9
Anode Current average	7 ma.	6 ma.	5.2 ma.	14 ma.	10 ma.	6 ma.
Amplification Factor			{ 15			{ 7.5
Impedance ..			{ 3,900 ohms			{ 2,150 ohms.
Mutual Conductance			{ 3.85 ma./volt (measured at grid volts 0)			{ 3.5 ma./volt (measured at grid volts 0)
Optimum Load ..	9,700 ohms			5,760 ohms.		

For prices see
pages 126-129.

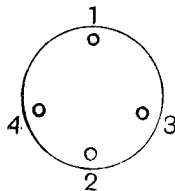

View looking on
underside of base

BASE, 4-PIN.

- Pin 1: Anode
- 2: Grid
- 3: Filament
- 4: Filament

TYPE LP2

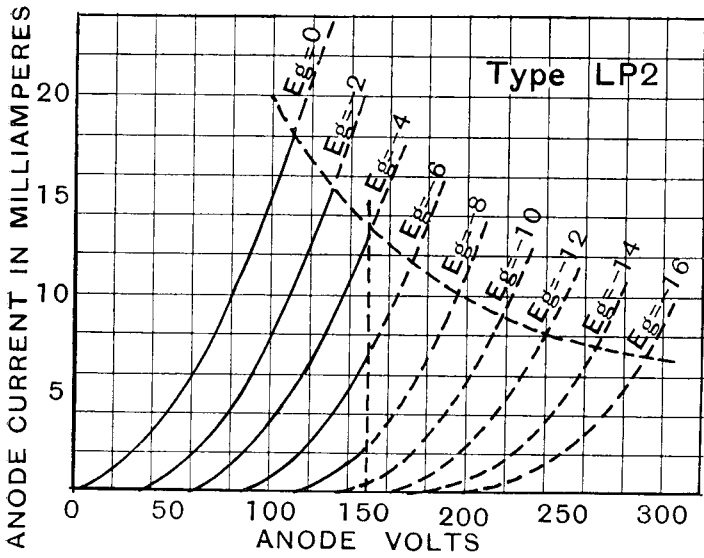

TYPE P2

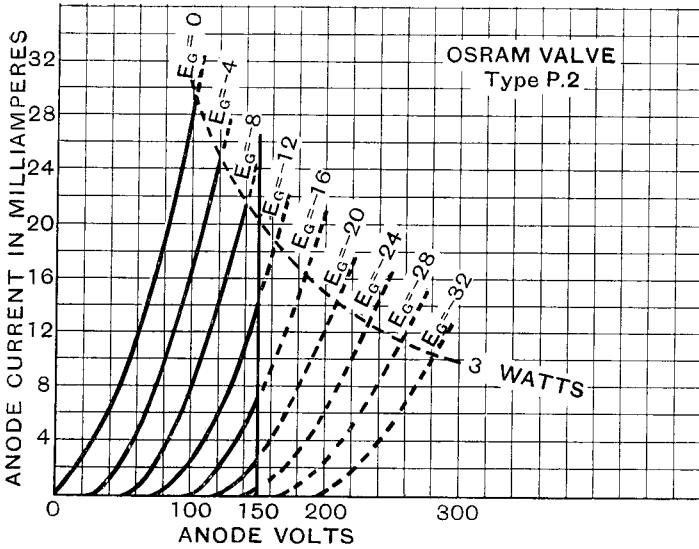

CHARACTERISTIC CURVES OF AVERAGE VALVES.



Osram Valves

Made in England.

TYPE PT2

PENTODE LOW FREQUENCY AMPLIFYING VALVE

(For use with a 2-Volt Accumulator).

Maximum Dimensions :
Overall length (including pins)
120 m/m.

Diameter of bulb
51 m/m.

The OSRAM PT2 is a high efficiency 2 volt Pentode, the characteristic of which is considerable undistorted power output combined with economy in H.T. and filament battery current. Owing to the high sensitivity of the PT2, it should be restricted to use in sets employing one stage only of low frequency amplification.

CHARACTERISTICS.

Filament Volts	2.0 max.	
Filament Current	0.2 amp.	
									Max.	
Anode Volts	150	150	100
Screen Volts	150	100	100
Grid Volts	-4.5	-3	-3
Anode Current average	9.5	4.5	4.5
Screen Current average	2.0	0.5	0.5
Mutual Conductance	2.5 ma/v
										measured
										at grid
										volts 0.
Optimum Load Resistance..	16,700 ohms.

For prices see
pages 126-129.

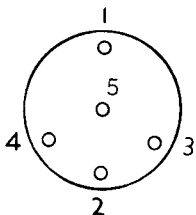

View looking on
underside of base.

BASE, 5-PIN.

- Pin 1 : Anode
- 2 : Grid
- 3 : Filament
- 4 : Filament
- 5 : Screen Grid

OPERATING CONDITIONS.

To obtain the maximum undistorted power output it is essential to couple the PT2 to the loudspeaker, by means of a suitable transformer or choke. A filter circuit consisting of a condenser of .01 mfd. approx. and a variable resistance of 50,000 ohms maximum should be connected between anode and filament. If any instability is experienced under maximum conditions the screen may be fed through a decoupling resistance of approximately 1,000 to 5,000 ohms, with a blocking condenser of 2 mfd. from screen to earth.

TYPE PT2

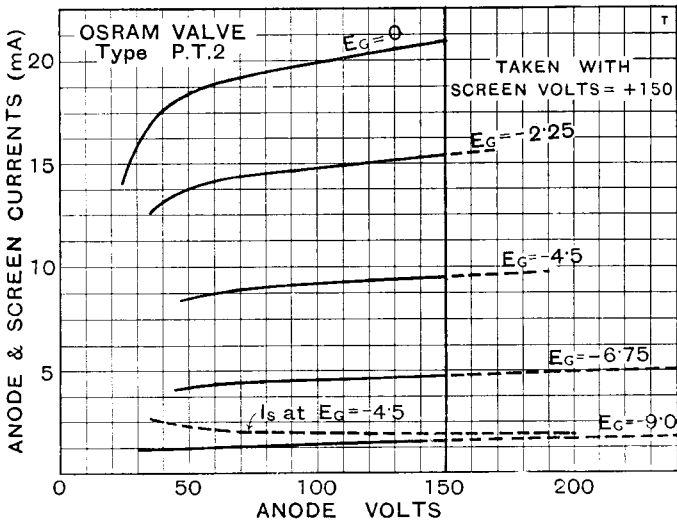
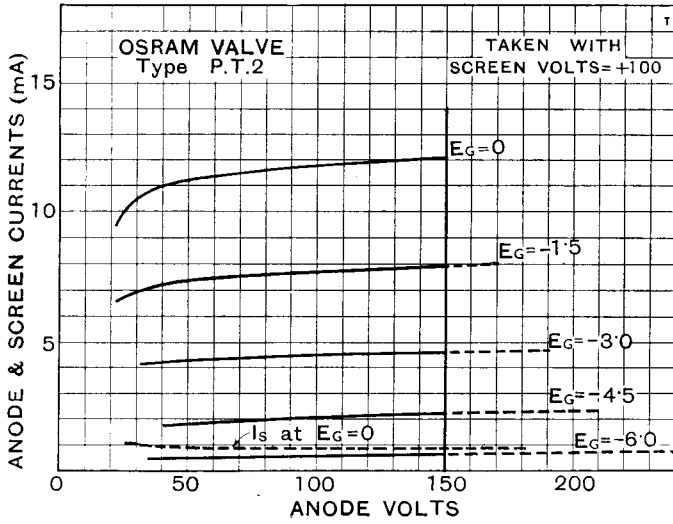

CHARACTERISTIC CURVES OF AVERAGE VALVE.

Osram Valves

Made in England.



Approx. Dimensions :
Overall length (including pins)
120 m/m.
Maximum Diameter of bulb
51 m/m.

TYPE QP21 QUIESCENT PUSH-PULL DOUBLE PENTODE VALVE

(For use with a 2-volt accumulator).

The OSRAM QP21 comprises two electrode systems in the one envelope and is designed for the output stage of 2-volt battery receivers in which this stage directly follows the Detector. In the method of use recommended, the standing anode current is restricted to a very small value and the actual high tension current is proportional to the strength of signal applied to the grids. By this means a considerable increase in power output becomes possible and at the same time an economy in average H.T. current is obtained.

CHARACTERISTICS.

Filament Volts	2.0 max.
Filament Current (total)	0.4 amp.
Anode Volts	150 max.
Screen Volts	150 max.
Mutual Conductance of each half	2.3 ma/volt measured at $E_a = 150$, $E_{sg} = 150$, $E_g = -4.5$.

For prices see
pages 126-129.

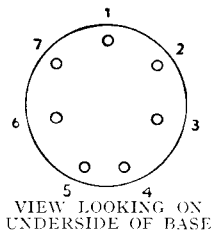

BASE, 7-PIN.

Pin 1:	Grid 1
2:	Grid 2
3:	Anode 2
4:	Filament and anti-secondary grid
5:	Filament
6:	Common Screen Grid
7:	Anode 1

OPERATING CONDITIONS.

To ensure absence of distortion it is important that an output transformer of good design with low leakage inductance and self-capacity should be employed.

Type QP21 is supplied in three groups each with a code letter, which is marked on the top of the bulb, indicating the recommended screen voltage to use with each class for a fixed grid bias or, alternatively, the recommended grid bias to use for a fixed screen voltage. It is recommended that H.T. voltages lower than 120 should be attempted. Type QP21 should not be operated under Positive Grid Current Class "B" conditions.

Operating data covering the three codes are given opposite.

Automatic bias may be employed if the maximum undistorted output is not required.

TYPE QP21

Anode Voltage	150	120
	Code Letter	Code Letter
Screen Voltage (for fixed bias conditions) ..	V W X	V W X
	140 146 150	99 105 111,5
	(grid bias -9v.)	(grid bias -6v.)
Grid Bias (for fixed screen voltage conditions) ..	-9.8 -9.5 -8.8	-7.8 -7.6 -7.1
	(screen voltage 150)	(screen voltage 120)
Average Quiescent Anode Current (ma.) ..	3.5	2.8
Average Quiescent Screen Current (ma.) ..	0.9	0.7
Output Load Resistance (Anode to Anode) ..	25,000 ohms	35,000 ohms
Average Full Load Anode Current (ma.) ..	12.5	8
Average Full Load Screen Current (ma.) ..	6	3

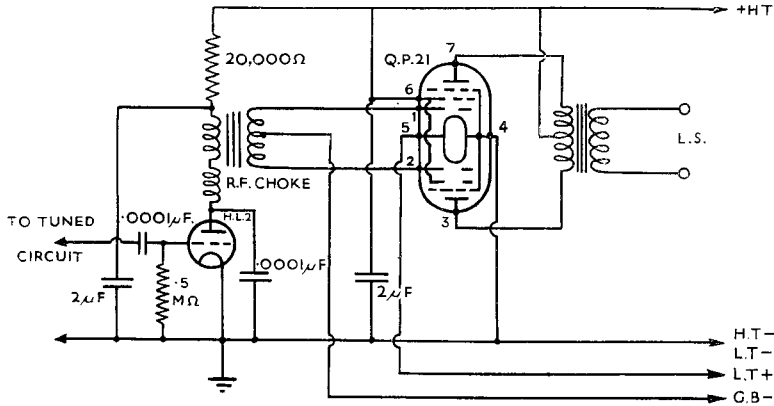

Circuit of QP21 with grid bias battery, and preceded by Leaky Grid Detector.

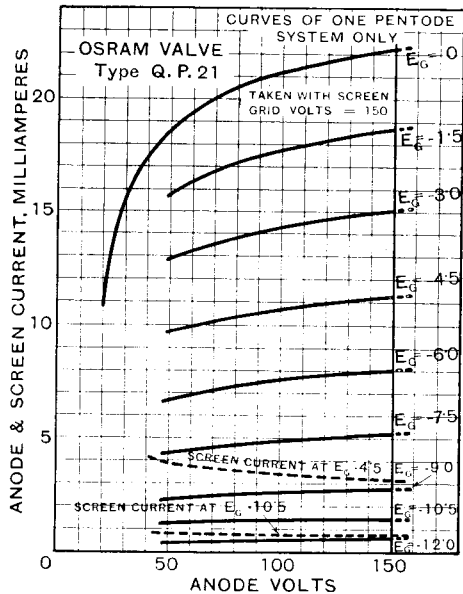
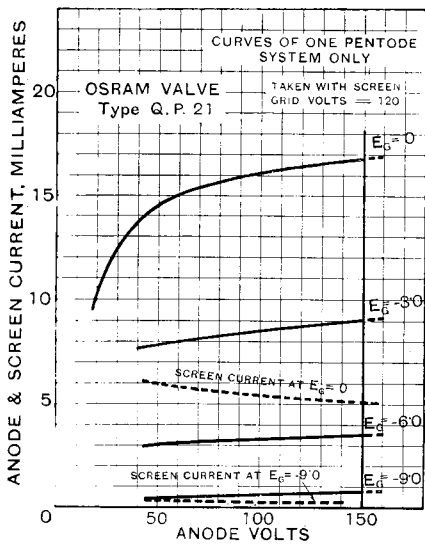

CHARACTERISTIC CURVES OF AVERAGE VALVE.



Made in England.

A.C. MAINS VALVES AND VALVES FOR POWER AMPLIFICATION

In the following pages will be found characteristics and technical data relating to the standard range of Indirectly Heated Valves for use in A.C. Mains Receivers, and large Power Amplifying types suitable for public address and similar equipments.

In the range of A.C. Mains Valves types are included which have been pioneers in increased efficiency—such as the X41 Triode Hexode, specially developed as a short wave Frequency Changer for superheterodyne receivers; N41, high sensitivity Power Pentode; PX25A and DA30 Power Triodes for Low Impedance Loading push-pull circuits, etc.

Types included are as follow :

For H.F. Amplification.

Screen Tetrodes with straight characteristic—MS4B.

Screen Tetrodes with Variable Mu characteristic—VMS4 and VMS4B.

Screen Pentodes with Variable Mu characteristic—VMP4G and W42.

For Detector.

Triode—MH4, H42.

Screen Tetrode—MS4B.

Screen Pentode—MSP4

Double Diode—D41.

Double Diode-Triode—MHD4.

Double Diode-Pentode—DN41.

As Frequency Changer.

MX40 Heptode.

X41 Triode Hexode.

X42 Heptode.

In L.F. Amplifier.

MH4, H42.

MHL4.

ML4.

As Loudspeaker Valve.

Power Pentodes—MPT4, N42, N41.

Power Triodes—PX4, PX25, PX25A, DA30, DA100.

Osram Valves

Made in England.



Maximum Dimensions :
Overall length (including pins)
140 m/m.
Diameter of bulb
45 m/m.

TYPE MS4B

SCREEN GRID AMPLIFYING AND DETECTOR VALVE

With Indirectly Heated Cathode.

(For operation from A.C. mains).

The OSRAM MS4B is a Screen Grid High Frequency amplifying valve fitted with an indirectly heated cathode. It is thus suitable for filament heating from A.C. mains through a step-down transformer without introducing objectionable hum.

The characteristics of the MS4B are designed to provide a high degree of magnification in sets employing one stage of High Frequency Amplification. It is also suitable as a Detector. The screen voltage must be supplied from a potentiometer and not by means of a dropping resistance.

CHARACTERISTICS.

Heater Volts	4.0	
Heater Current	1.0 amp. approx.	
	Max.	
Anode Volts	250 ..	200
Screen Volts	80 ..	80
Grid Volts	-1	
(for operation in amplifier)		
Anode Current average	3.4 m.a.	
Screen Current average	1.2 m.a.	
Amplification Factor		1,120
Impedance		350,000 ohms.
Mutual Conductance		3.2 ma/volt measured at grid volts 0.
Automatic Bias Resistance in Amplifier	250 ohms.	
" " As self-biased Anode Bend Detector	15,000 ohms.	
Optimum Load Resistance in Amplifier and as Grid Leak Detector	30,000 ohms.	
" " as self-biased Anode Bend Detector	400,000 ohms.	

Interelectrode Capacities :—

Anode-Grid (others earthed)	0.0023 micro-microfarad approx.
Grid—other electrodes	12.0 " " "
Anode—other electrodes	7.3 " " "

(taken on metallised valve).

For prices see
pages 126-129.

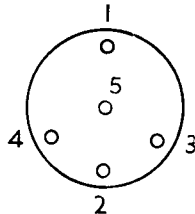

View looking on
underside of base.

BASE, 5-PIN.

- 1: Screen
 - 2: Grid
 - 3: Heater
 - 4: Heater
 - 5: Cathode and Metallising
- Top Cap: Anode

Type MS4B is supplied with either clear or metallised bulb, according to requirements.

TYPE MS4B

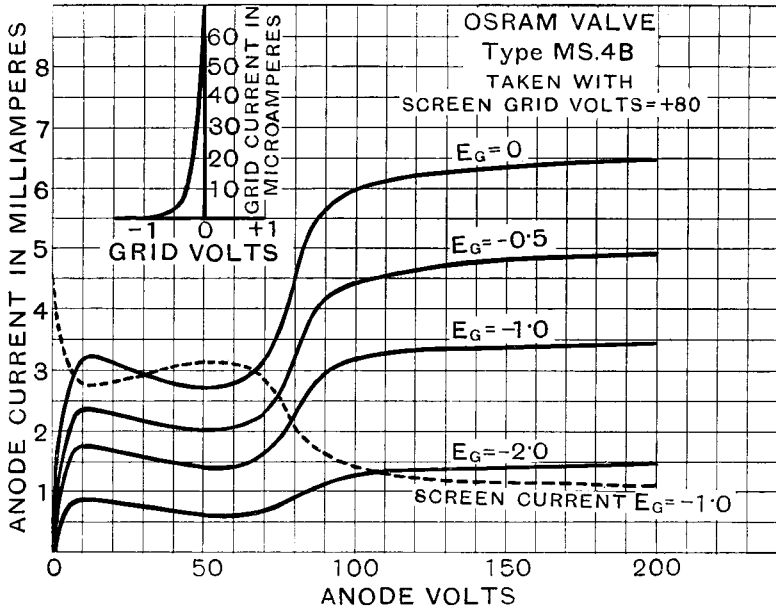

CHARACTERISTIC CURVES OF AVERAGE VALVE.

Osram Valves

Made in England.

TYPE VMS4 TYPE VMS4B

“ VARIABLE MU ”
SCREEN GRID HIGH FREQUENCY
AMPLIFYING VALVES
With Indirectly Heated Cathode
(For operation from A.C. mains).



Maximum Dimensions :
Overall length (including pins)
140 m m.

Diameter of bulb
45 m m.

The OSRAM VMS4 is a screen grid valve with characteristics primarily designed to reduce cross modulation and to permit easy control of a large range of signal input voltages.

It is intended to be employed as a screen grid H.F. or Intermediate Frequency amplifier in which the volume control is affected by means of variation to grid bias.

The maximum mutual conductance may conveniently be limited to any desired extent by choice of the fixed value of bias resistance in the cathode lead.

Particular features of the Osram VMS4 are linearity of the characteristic, extremely low grid-anode capacity, and long operating grid base.

Features of the OSRAM VMS4B are high grid volt-mutual conductance ratio, giving full control of magnification with relatively small grid bias, linearity of characteristic, extremely low grid-anode capacity, and high value of maximum conductance.

CHARACTERISTICS.

	VMS4				VMS4B			
Heater Volts	4.0	4.0
Heater Current	1.0 amp. approx.	1.0 amp. approx.
Anode Volts	250 max.	250 max.
Screen Volts	80 max.	80 max.
Grid Volts	0	-1	-3	-40	0	-1	-3	-15
Anode Current average	14.0	11.0	7.5	0.08 ma.	8.0	5.2	2.1	0.2 ma.
Screen Current average	3.0	2.5	1.7	—	1.5	1.1	0.6	—
Mutual Conductance ..	2.4	2.1	1.5	0.04 mA/v.	2.9	2.4	0.8	0.04 mA/v
Fixed Bias Resistance	—	50	300	ohms	—	150	1,000	ohms.
Inter-electrode Capacities :								
Grid—Anode (others earthed)	0.0024 micro-microfarad approx.				0.0025 micro-microfarad approx.			
Grid—other electrodes	11.25	12.0
Anode—other electrodes	7.7	8.1
	(taken on metallised valve).							

For prices see
pages 126-129.

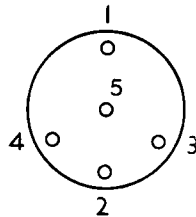

View looking on
underside of base.

BASE, 5-PIN.

- 1: Screen
- 2: Grid
- 3: Heater
- 4: Heater
- 5: Cathode & Metallising

Top Cap : Anode

Types VMS4 and VMS4B can be supplied with either clear or metallised bulbs, according to requirements.

TYPE VMS4 TYPE VMS4B

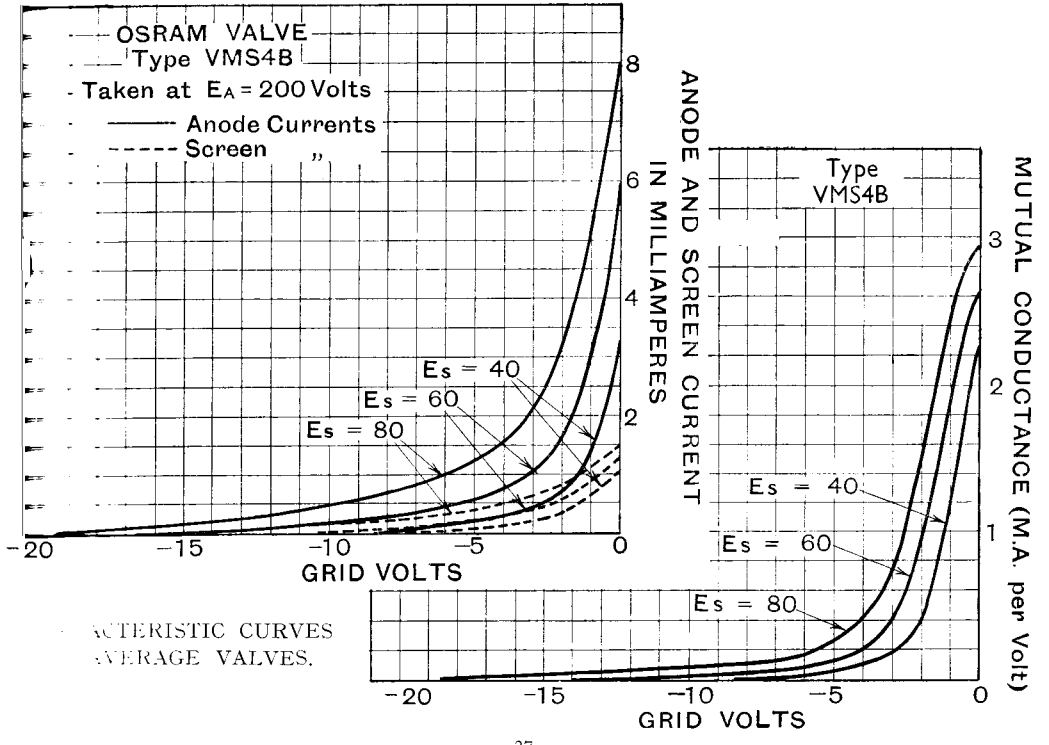
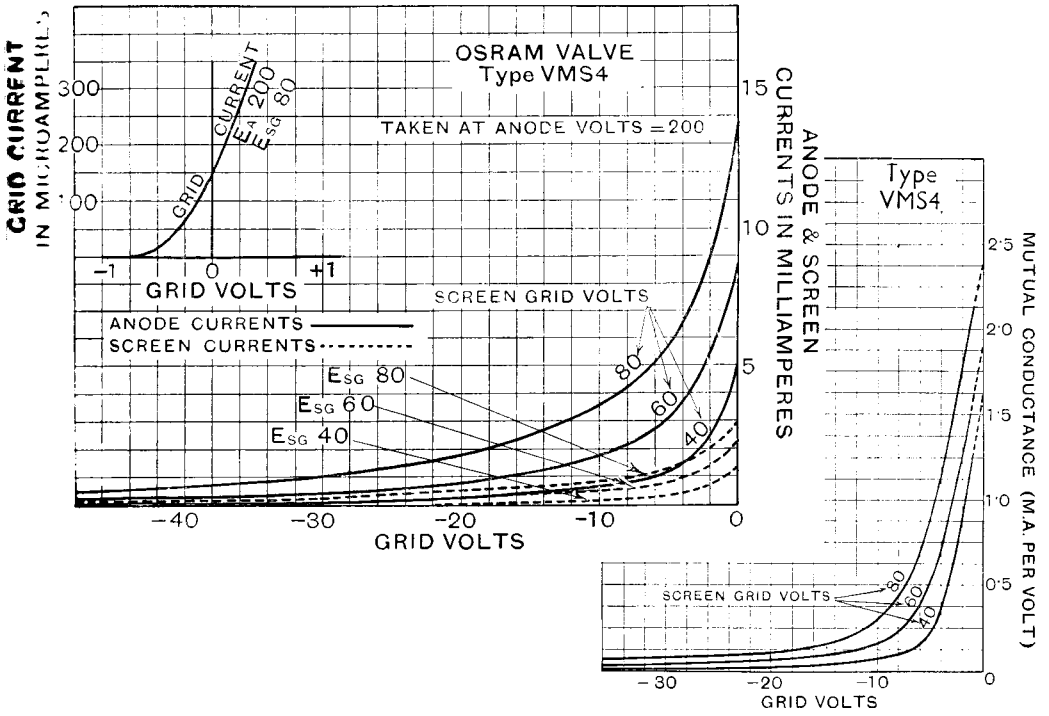

CHARACTERISTIC CURVES
AVERAGE VALVES.

Osram Valves

Made in England



Maximum Dimensions :
Overall length (including pins)
140 m/m
Diameter of bulb 45 m/m.

TYPE VMP4G VARIABLE MU SCREEN PENTODE

With Indirectly Heated Cathode

(For operation from A.C. Mains).

The OSRAM VMP4G is a Variable Mu Screen Pentode suitable for use in the High Frequency or Intermediate Frequency Amplifying portions of a receiver.

An important feature of the VMP4G is the low value of anode-grid interelectrode capacity. This, in conjunction with the pentode characteristic affords a means of obtaining considerable voltage magnification in the valve and its associated tuned circuit, while at the same time maintaining stability of operation and minimum feed-back.

CHARACTERISTICS.

Heater Volts	4.0
Heater Current	1.0 amp. approx.
							Recommended Operating Condition.
Anode Volts	250	250
Screen Volts	100	100
Control Grid Volts	-2
Anode Current average	8.0 m.a.
Screen Current average	5.0 m.a.
Fixed Bias Resistance	150 ohms
Mutual Conductance	2.7 ma/volt
							0.01 ma/volt
Interelectrode Capacities :-							
Grid—Anode (others earthed)	0.0026 micro-microfarad approx.
Anode—other electrodes	8.7
Grid—other electrodes	14.0

For prices see
pages 126-129.

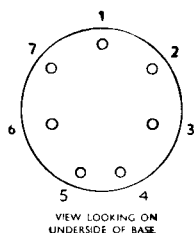

BASE, 7-PIN.

- 1: Metallising.
 - 2: Grid.
 - 3: Suppressor Grid.
 - 4: Heater.
 - 5: Heater.
 - 6: Cathode.
 - 7: Screen Grid.
- Top Cap: Anode.
- Supplied in metallised bulb only.

RECOMMENDED OPERATING CONDITIONS.

It is recommended that a potentiometer network should be employed in order to maintain the screen voltage at a constant potential with variation to grid bias. In some cases, however, such as in the second stage of an I.F. amplifier, a greater voltage output can be obtained by feeding the screen grid through a dropping resistance. This allows the screen voltage to rise and thus increases the grid base and available output with increasing grid bias or signal strength. When used as a controlled valve in A.V.C. circuits it is recommended that any grid resistance employed for decoupling purposes should have a value not exceeding 0.5 megohm.

TYPE VMP4G

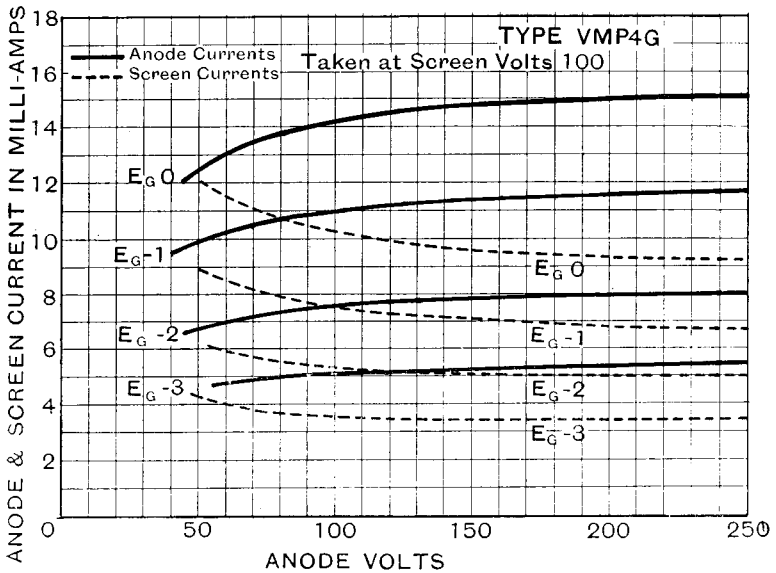
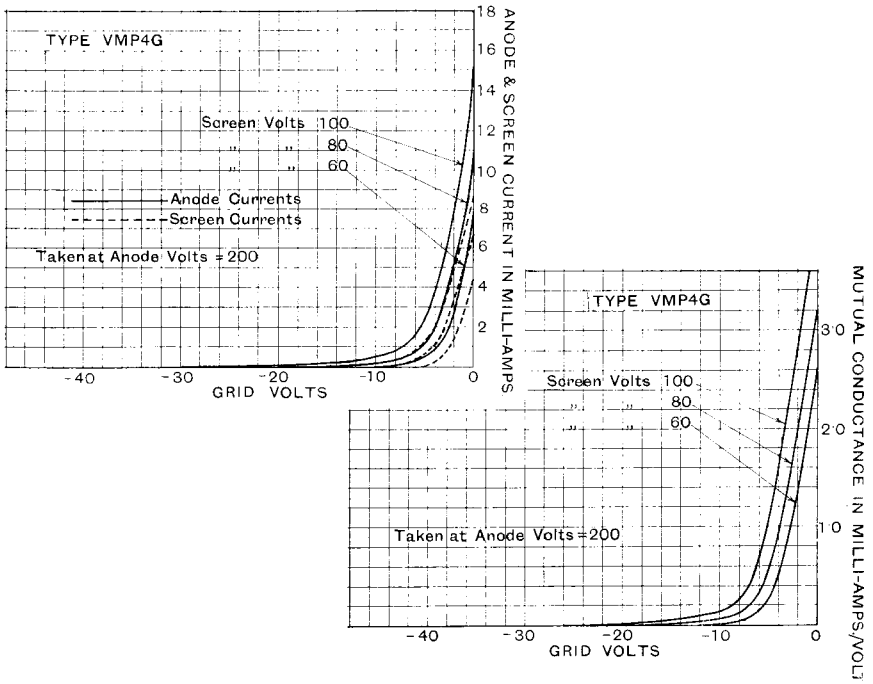

CHARACTERISTIC CURVES OF AVERAGE VALVE.

Osram Valves

Made in England



Maximum Dimensions :
Overall length (including pins)
120 m m.
Diameter of bulb 41.5 m m.

TYPE W42

VARIABLE MU SCREEN PENTODE

With Indirectly Heated Cathode
(For operation from A.C. Mains).

The OSRAM W42 is a Variable Mu Screen Pentode suitable for use in a high frequency or intermediate frequency amplifier. The heater has a 2.4 watt rating which makes for economical running. The variable Mu characteristics enable control of volume to be effected by variation of grid bias voltage, and the operating grid base is adequate to allow for full A.V.C. to be applied without modulation distortion on normal signals inputs.

In this valve the control grid is taken to a top cap connection which reduces the input capacity and is of advantage in the layout of certain receiver designs.

CHARACTERISTICS.

Heater Volts	4.0
Heater Current	0.6 amp. approx.
	Recommended Operating Conditions.
	Max.
Anode Volts	250
Screen Volts	125
Control Grid Volts	0
Anode Current average	7.6
Screen Current average	1.9
Fixed Bias Resistance	300 ohms
Mutual Conductance	1.75 mA/v. 1.5 mA/v. 0.0045 mA/v.
	(at $E_g = 0$)

Interelectrode Capacities :—

Grid to Anode (others earthed)	0.005 m.mfd. approx.
Anode to other Electrodes	10.4 " "
Grid to other Electrodes	5.1 " "

For prices see
pages 126-129.

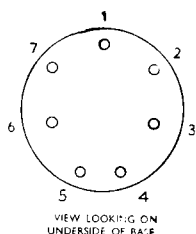

VIEW LOOKING ON
UNDERSIDE OF BASE

BASE, 7-pin.

- Pin 1: —
2: Anode
3: Suppressor Grid
4: Heater
5: Heater
6: Cathode
7: Screen Grid
Top Cap: Grid

Type W42 has a carbonised bulb and is supplied unmetallised only.

TYPICAL OPERATING CONDITIONS.

It is recommended that a potentiometer network should be employed in order to maintain the screen voltage sensibly constant. The total effective resistance between the grid and cathode must not exceed 2 megohms. The valve is not metallised, but in cases where screening is essential a can with the following dimensions may be used: The suggested length of the can is 78 m/m, extending from the bottom of the bakelite base to the centre of the earthed screen inside the dome of the bulb. The diameter should be about 42.5 m/m. These dimensions should be closely followed in order to take full advantage of the low value of anode to grid capacity.

TYPE W42

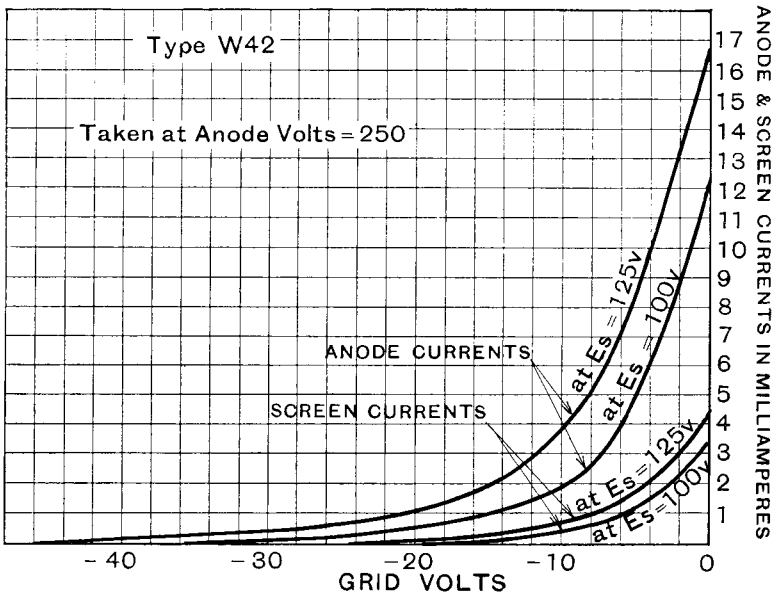
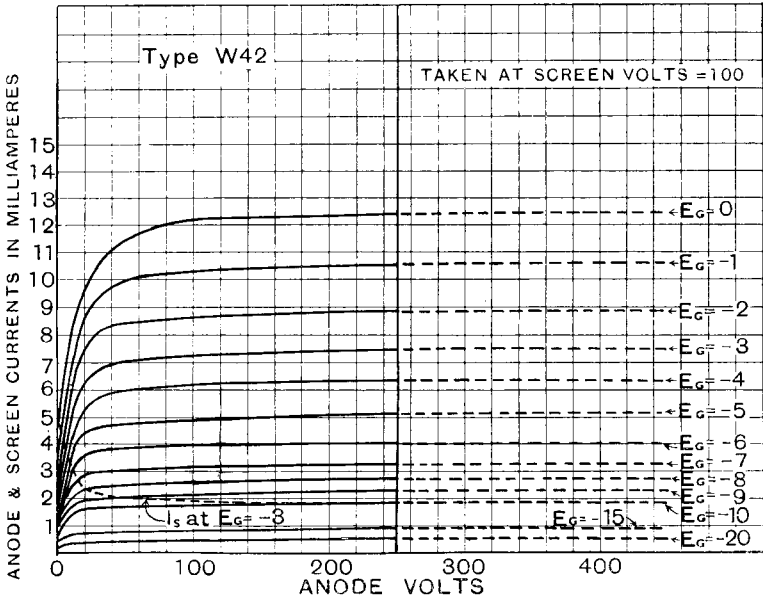

CHARACTERISTIC CURVES OF AVERAGE VALVE.



Osram Valves

Made in England

TYPE MSP4 SCREEN-PENTODE DETECTOR AND AMPLIFYING VALVE

With Indirectly Heated Cathode
(For operation from A.C. mains).

The OSRAM MSP4 is an Indirectly Heated Pentode for use with A.C. Mains Receivers, suitable for operation in the High Frequency portion of a receiver.

The MSP4 may also be used as a Detector or Low Frequency amplifier valve.

As a Detector it operates with high efficiency and imposes very little damping on the input circuit.

Maximum Dimensions :
Overall length (including pins)
140 m/m.

Diameter of bulb 45 m/m.

CHARACTERISTICS.

Heater Volts	4.0
Heater Current	1.0 amp. approx.
									Recommended Operating Conditions.
Anode Volts	Max.	250
Screen Volts		100
									As Detector (Grid Leak)
									As Detector (Anode Bend)
Grid Volts	In Amplifier	0
Anode Current average		-3.0
Screen Current average		9.5 ma
Automatic Bias Resistance		1.5 ma
Anode Load Resistance		0.5 ma
Mutual Conductance		1,500 ohms
									25,000 ohms
									100,000 ohms
									400 ohms
									—
									25,000 ohms
									100,000 ohms
									4.0 m/a volt
									4.0 m/a volt
									(at grid volts -1.75) (at grid volts 0)
									0.013 micro-microfarad approx.
									17.2 "
									10.0 "
									" "
									" "

Interelectrode Capacities:—
Grid—Anode (others earthed)
Grid—other electrodes
Anode—other electrodes
(taken on metallised valve)

For prices see
pages 126-129.

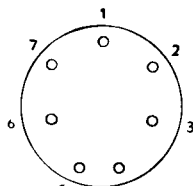

VIEW LOOKING ON
UNDERSIDE OF BASE

BASE, 7-PIN.

- 1: Metallising
- 2: Grid
- 3: Suppressor Grid
- 4: Heater
- 5: Heater
- 6: Cathode
- 7: Screen

Top Cap: Anode

Types MSP4 and MSP41 have carbonised bulbs and can be supplied metallised if required.

TYPE MSP41

Maximum Dimensions :
Overall length (including pins)
140 m/m.

Diameter of bulb
45 m/m.

For prices see
pages 126-129.

The OSRAM MSP41 is a screen pentode similar in characteristic to type MSP4 but designed to withstand screen voltages up to 240 max.

The mutual conductance under working conditions in an amplifier is higher than with type MSP4 and the available stage gain thus increased.

Mutual conductance 3.2 m.a./volt.
at Anode volts 250
Screen volts 240
Grid volts -4

Total cathode current 12 m.a. approx.
Base, 7-pin : connections as for MSP4.

TYPE MSP4 & TYPE MSP41

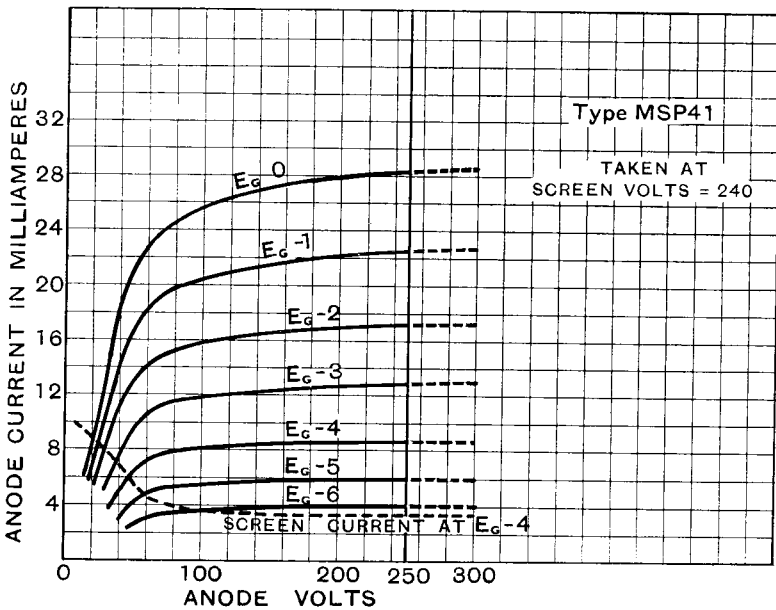
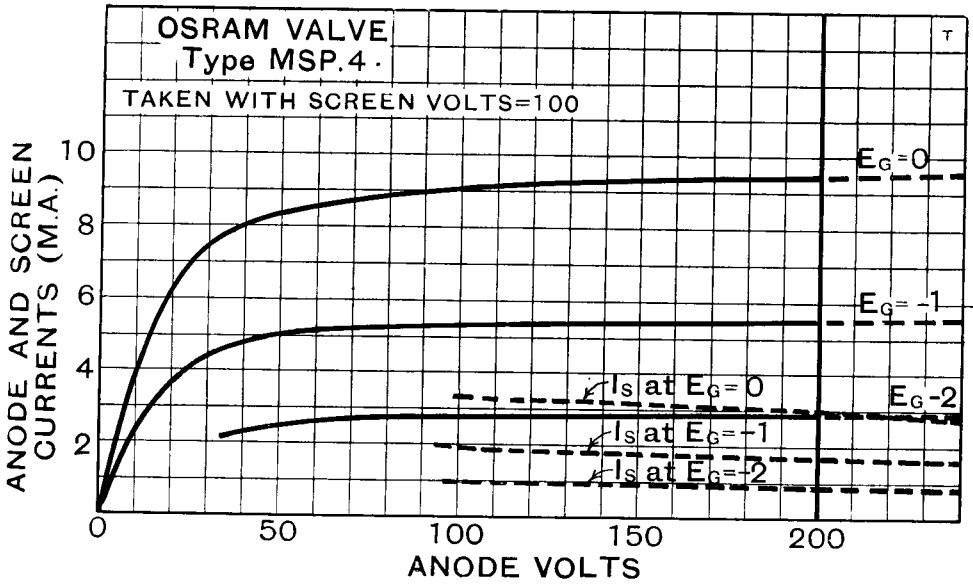

CHARACTERISTIC CURVES OF AVERAGE VALVES.

Osram Valves

Made in England.



Maximum Dimensions :
Overall length (including pins)
130 m/m.
Diameter of bulb
45 m/m.

TYPE MX40 HEPTODE FREQUENCY CHANGER With Indirectly Heated Cathode (For operation from A.C. mains).

The OSRAM MX40 is a multi-electrode type valve designed to perform as a frequency changer in superheterodyne receivers.

Type MX40 contains five electrodes in addition to the normal cathode and anode, the function of these electrodes being as follows :

- G₁ (in proximity to cathode) : Oscillator Grid.
- G₂ Oscillator Anode.
- G₃ Screen Grid.
- G₄ Control Grid with "Variable Mu" characteristics.
- G₅ Screen Grid (joined internally to G₃).

The control grid of this valve has variable-mu characteristics which makes it suitable for use in circuits employing automatic volume control.

CHARACTERISTICS.

Heater Volts	4.0	
Heater Current	1.0 amp. approx.	
		Max. Recommended Operating Condition.
Anode Volts	250	250
Screen Volts	100	80
Oscillator Anode Volts.. .. .	150	150
Oscillator Grid Peak Swing		10 volts
Control Grid Voltage		-3 -10 -30
Total Cathode Current average	5.85	5.7 5.4 ma
Conversion Conductance average	500	30 2.5 micromhos
Conversion Impedance.. .. .	0.5 megohm	

Interelectrode Capacities :—

Control Grid—Anode	0.3 micro-microfarad approx.
Control Grid—Oscillator Anode	0.2 " " "
Control Grid—other electrodes	13.3 " " "
Oscillator Grid—Oscillator Anode	2.6 " " "
Oscillator Anode—other electrodes	9.4 " " "
Oscillator Grid—other electrodes	11.25 " " "
Oscillator Grid—Control Grid	0.22 " " "

(taken on metallised valve)

For prices see
pages 126-129.

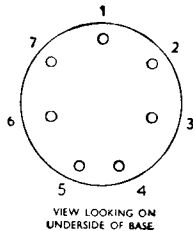

BASE, 7-PIN.

- 1 : Oscillator Anode G₂
- 2 : Oscillator Grid G₁
- 3 : Screen G₃, G₅
- 4 : Heater
- 5 : Heater
- 6 : Cathode & Metallising
- 7 : Anode

Top Cap : Control Grid G₄

Type MX40 is supplied with metallised or plain carbonised bulb, according to requirements.

TYPE MX40

TYPICAL OPERATING CONDITIONS.

When operating as a Frequency Changer, the oscillator anode voltage should be about twice that of the screen voltage. The optimum performance is obtained when the screen voltage is of the order of 80 volts. Lower values than this will increase the sensitivity but may lead to parasitic oscillation of the oscillator under certain conditions.

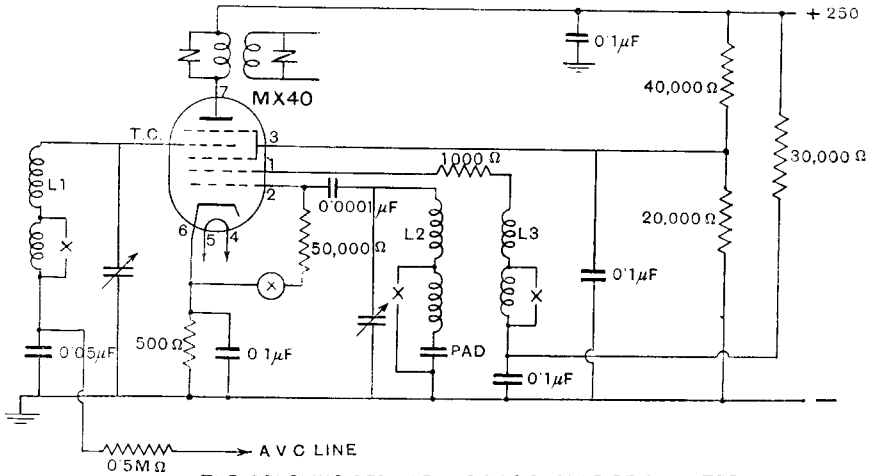

THE COUPLING BETWEEN L2 & L3 SHOULD BE ADJUSTED UNTIL A MILLIAMMETER INSERTED AT THE POINT (X) IN SERIES WITH THE GRID LEAK GIVES A READING OF 0.2 MILLIAMPERES

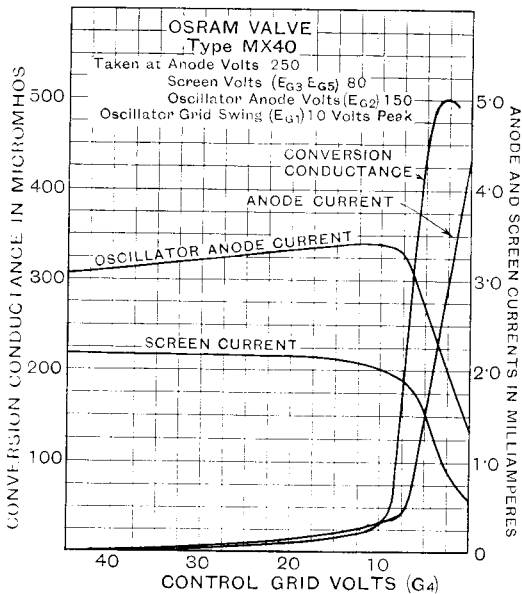

CHARACTERISTIC CURVES

OF

AVERAGE VALVE.

Osram Valves

Made in England.

TYPE X41

TRIODE-HEXODE FREQUENCY CHANGER.

With Indirectly Heated Cathode.
(For Operation from A.C. Mains).



Maximum dimensions :
Overall length (including
pins) 135 m/m.
Diameter of bulb 45 m/m.

The OSRAM X41 is a multi-electrode valve designed to perform as a mixer, first detector or frequency changer valve in a superheterodyne receiver. It is fitted with an Indirectly Heated Cathode common to two sets of electrodes :

- (1) The Hexode.
- (2) The Triode.

The triode grid is connected to a mixer grid internally so that oscillations generated by the triode modulate the hexode cathode stream. The control grid of the hexode portion may be connected to an A.V.C. line, as it has "variable mu" characteristics.

The triode hexode offers the following points of advantage :

- (1) Almost complete absence of interaction between triode and hexode sections.
- (2) High mutual conductance in the triode section.
- (3) High conversion gain due to its high impedance.

Type X41 is applicable to short wave reception in a suitable circuit as shown.

CHARACTERISTICS.

Heater Volts	4.0	
Heater Current	1.2 amp. approx.	
		Recommended Operating Condition.
	Max.	
Anode Volts	250	250
Screen Volts	80	70
Oscillator Anode Volts	150	100
Oscillator Grid Peak Swing	12 peak.	10—12 peak.
Control Grid Voltage	—1.5v.
Conversion Conductance average	640 micromhos.
Conversion Impedance	0.75 megohms.
Total Cathode Current average	7.6 ma.

Interelectrode Capacities :—

Control Grid—Anode	0.046 micromicrofarad approx.
Anode—Earth	21.5 " " "
Control Grid—Earth	7.0 " " "
Oscillator Grid—Oscillator Anode	3.56 " " "
Oscillator Anode—Earth	8.5 " " "
Oscillator Grid—Earth	17.0 " " "
Oscillator Grid—Control Grid	0.26 " " "

(Taken on metallised valve)

For prices see
pages 126-129.

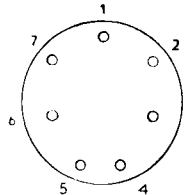

VIEW LOOKING ON
UNDERSIDE OF BASE

BASE 7-PIN.

- 1: Oscillator Anode (A₁)
 - 2: Oscillator and Mixer Grids (G₁, G₂)
 - 3: Screen (G₃, G₄)
 - 4: Heater
 - 5: Heater
 - 6: Cathode
 - 7: Anode (A₂)
- Top Cap: Control Grid (G₅)

Type X41 is supplied in metallised or plain carbonised bulb, according to requirements.

TYPE X41

TYPICAL OPERATING CONDITIONS.

A typical circuit is shown herewith. The Screen grid should be fed from a low resistance potentiometer and care should be taken to reduce to a minimum any coupling between the oscillator and signal frequency circuits. To prevent modulation hum in short wave receivers condensers of approximately 0.01 mfd. should be connected from each side of the heater to earth. Care should be taken that the total resistance in the control grid to cathode circuit (A.V.C. decoupling resistances, etc.) does not exceed 2 megohms effective value.

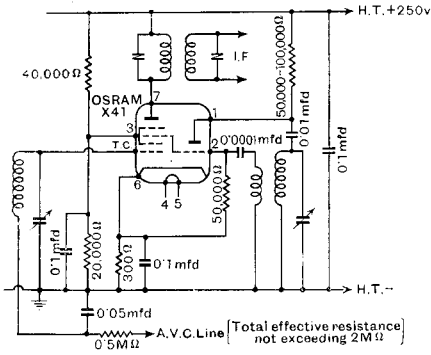

OSRAM X41 for Long, Medium, & Short wave reception (2,000-10metres)

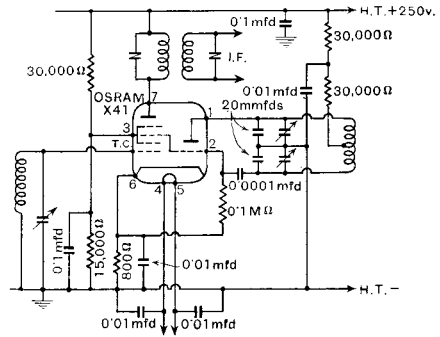

OSRAM X41 for Ultra Short wave reception (5-10metres)

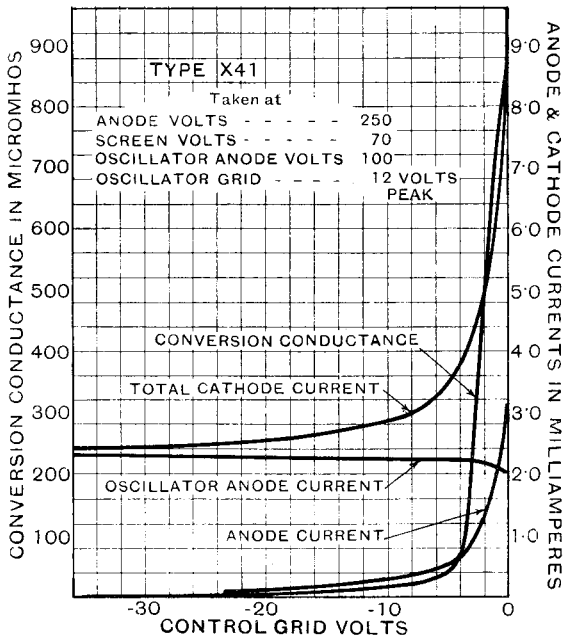

CHARACTERISTIC CURVES OF AVERAGE VALVE



Osram Valves

Made in England

TYPE X42 HEPTODE FREQUENCY CHANGER With Indirectly Heated Cathode. (For operation from A.C. Mains).

The OSRAM X42 is an Indirectly Heated Variable Mu Heptode having the advantages of a short electrode assembly, thus making for low interelectrode capacities and economical operation. Due to the high conversion conductance of this valve a very satisfactory performance will be obtained in a suitably designed circuit.

The X42 may be operated successfully down to a wavelength of 15 metres, in which case it is essential that the input and oscillator circuits be thoroughly screened.

Maximum Dimensions :
Overall length (including pins)
120 m m.
Diameter of bulb 41 m m.

CHARACTERISTICS.

Heater Volts	4.0	
Heater Current	0.6 amp. approx.	
		Recommended Operating Conditions.
	Max.	
Anode Volts	250	250
Screen Volts	100	100
Oscillator Anode Volts	200	250 through 20,000 ohms.
Oscillator Grid Peak Swing	—	25 volts
Control Grid Voltage	—	-3 -45
Total Cathode Current average	—	9.5 —
Conversion Conductance average	—	490 8 Micromhos
Conversion Impedance	—	310,000 ohms.
Interelectrode Capacities:		
Control Grid to Anode	0.95 micro-mfds. approx.	
Control Grid to Oscillator Anode	0.23	" "
Control Grid to other Electrodes	8.58	" "
Oscillator Grid to Oscillator Anode	1.64	" "
Oscillator Anode to other Electrodes	6.98	" "
Oscillator Grid to other Electrodes	8.68	" "
Oscillator Grid to Control Grid	0.27	" "

For prices see
pages 126-129.

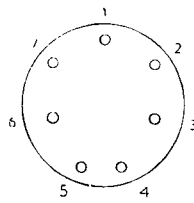

VIEW LOOKING ON
UNDERSIDE OF BASE

BASE, 7-pin

- 1: Oscillator Anode G₂
- 2: Oscillator Grid G₁
- 3: Screen G₃ G₅
- 4: Heater
- 5: Heater
- 6: Cathode
- 7: Anode

Top Cap: Control Grid G₄

Type X42 has a carbonised bulb and is supplied unmetallised only.

OPERATING CONDITIONS.

Automatic grid bias must always be used in order to prevent the danger of the anode current rising to a high figure under certain operating conditions. The total oscillator grid G₁ to cathode resistance must not exceed 2 megohms. The screen grids G₃ G₅ must be fed from a potentiometer network which gives good regulation. The oscillator anode G₂ should be fed from a series resistance in order to limit the rise in anode current. For optimum performance the oscillator anode voltage should be at least double the screen voltage.

A resistance should be included in the oscillator anode circuit in order to keep the oscillator voltage constant over the working band on radio frequencies. Its value depends upon the design of the oscillator coils.

TYPE X42

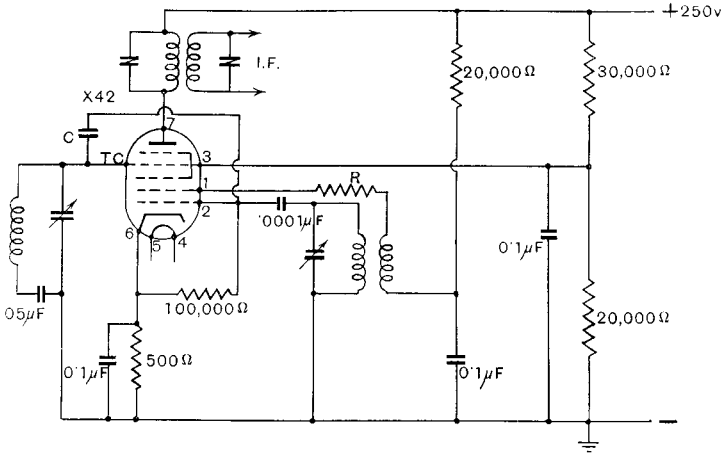

C = Neutralising condenser 1 to $2\mu\mu\text{F}$ approx.
 R = Resistance dependant on design of oscillator coils

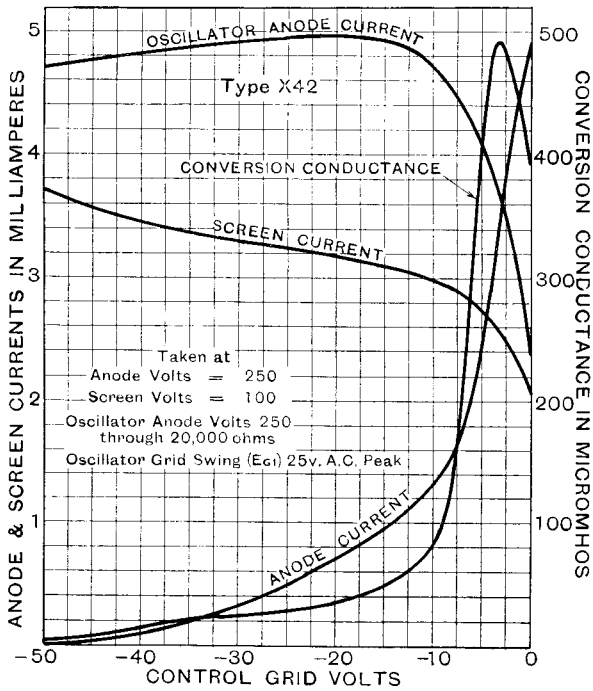

CHARACTERISTIC CURVES OF AVERAGE VALVE.

Osram Valves

Made in England.



Maximum Dimensions :
Overall length (including pins) 100 m/m.
Diameter of bulb 36 m/m.

TYPE D41 DOUBLE DIODE

With Indirectly Heated Cathode

The OSRAM D41 is a Double Diode Valve for use as a combined Detector and Automatic Volume Control Valve in radio receivers. Its filament rating makes it suitable for either parallel or series filament running so that it can be used with the 4-volt or 0.3 ampere ranges of valves respectively.

A diode such as the D41 is the ideal Detector Valve as it provides practically perfect undistorted detection when operated at suitable values of input voltage.

CHARACTERISTICS

Heater Volts	4.0
Heater Current	0.3 amp.

With Load Resistance 0.25 megohm:—

A.C. volts R.M.S.	5	10	15	20	25
D.C. average current in microamps	..	25	52	78	100	130

Max. L.F. volts when fed at 30% modulation 7 volts peak

Interelectrode Capacities:—

Diode (1) to Cathode (others earthed)	3.5 m.mfd. approx.
Diode (2) to Cathode (others earthed)	2.5 m.mfd. „
Diode to Diode	0.5 m.mfd. „

(Taken on Metallised Valve)

For prices see
pages 126-129.

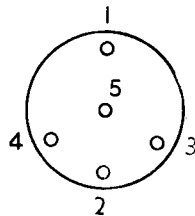

View looking on underside of valve base

- BASE 5-PIN.**
- 1: Diode
 - 2: Diode
 - 3: Heater
 - 4: Heater
 - 5: Cathode and Metallising

Type D41 is supplied in metallised or clear bulb according to requirements.

TYPE D41

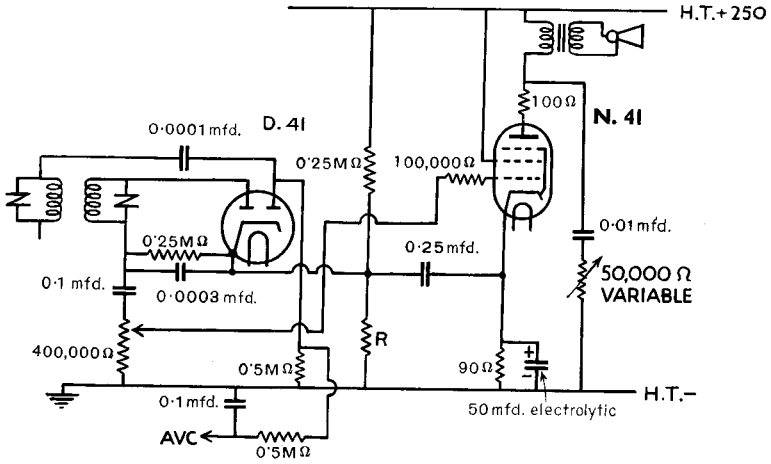

$R = \text{Value depending on delay voltage required}$
 where delay volts = $\frac{R}{R + 0.25M\Omega} \times \text{H.T. volts.}$

A typical circuit for D41 operating as Detector and for delayed A.V.C. feeding into N41 output Pentode is shown above.

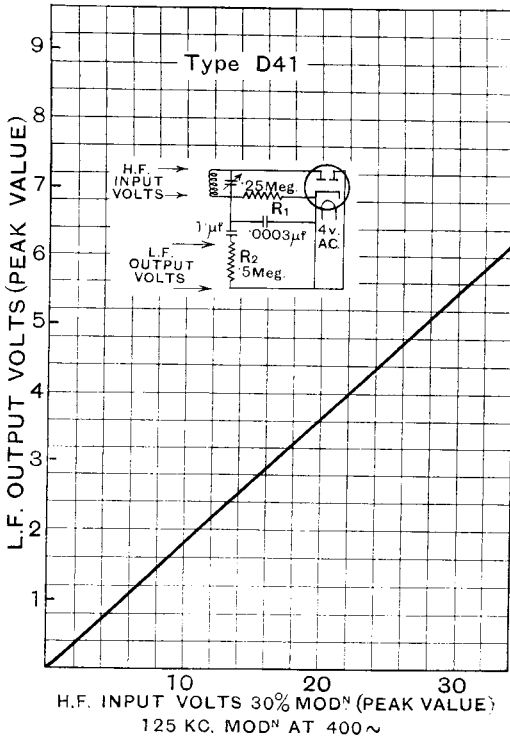

AVERAGE CHARACTERISTIC CURVE.

Osram Valves

Made in England



Maximum Dimensions :
Overall length (including pins)
125 m|m.
Diameter of bulb 45 m|m.

TYPE MHD4

DOUBLE DIODE TRIODE

With Indirectly Heated Cathode
(For operation from A.C. Mains).

The OSRAM MHD4 is an Indirectly Heated Cathode Valve suitable for use on A.C. Mains, and combining double diode and triode electrode systems on a common cathode, and affording a convenient means to effect Automatic Volume Control.

The two diodes are enclosed within a metal shield joined to the cathode, providing an electrostatic screen.

In this valve rectification and amplification are separated, so that the former may be effected by means of a simple diode, and the rectified output applied to the grid of the triode element. The second diode can be employed in one of two ways:—

- (a) In conjunction with the first diode anode to provide full wave rectification of the applied signal.
- (b) In conjunction with a separate circuit to provide Automatic Volume Control.

CHARACTERISTICS.

Heater Volts	4.0
Heater Current	1.0 amp. approx.
Triode Characteristics:—	
	Max.
Anode Volts	250
Grid Volts	-3
Anode Current average	3.8 ma
Amplification Factor	200
Impedance	100
Mutual Conductance	-1
	2.8 ma
	40
	18,200 ohms.
	2.2 ma/volt
	(measured at anode volts 100, grid volts 0)

Diode Characteristics. With 0.5 megohm diode load resistance.

A.C. Volts R.M.S.	D.C. Volts Across Diode Load.
5	5
10	12
15	19
20	25
25	32

Interelectrode Capacities:—

Triode Grid—Anode	3.76 micro-microfarad approx.
Triode Grid—Cathode	2.42 " " " "
Triode Anode—Cathode	4.64 " " " "
Each diode anode—Triode grid	0.14 " " " "
Diodes—all other electrodes	12.73 " " " "

(taken on metallised valve)

For prices see
pages 126-129.

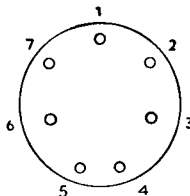

BASE, 7-PIN.

- 1: Diode
- 2: Metallising
- 3: Diode
- 4: Heater
- 5: Heater
- 6: Cathode
- 7: Anode

Top Cap: Grid

View looking on underside of base.

Type MHD4 has a carbonised bulb and can be supplied metallised if required.

TYPE MHD4

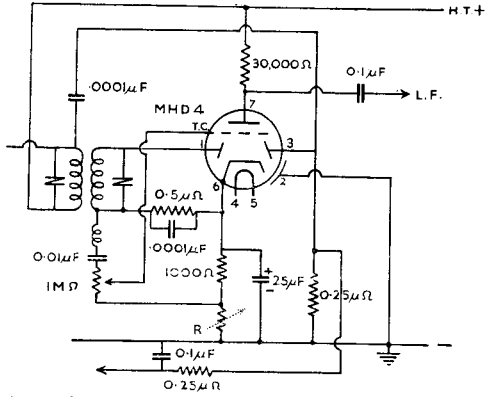

R=Resistance for delay voltage on diode. A suitable value is 5,000 ohms.

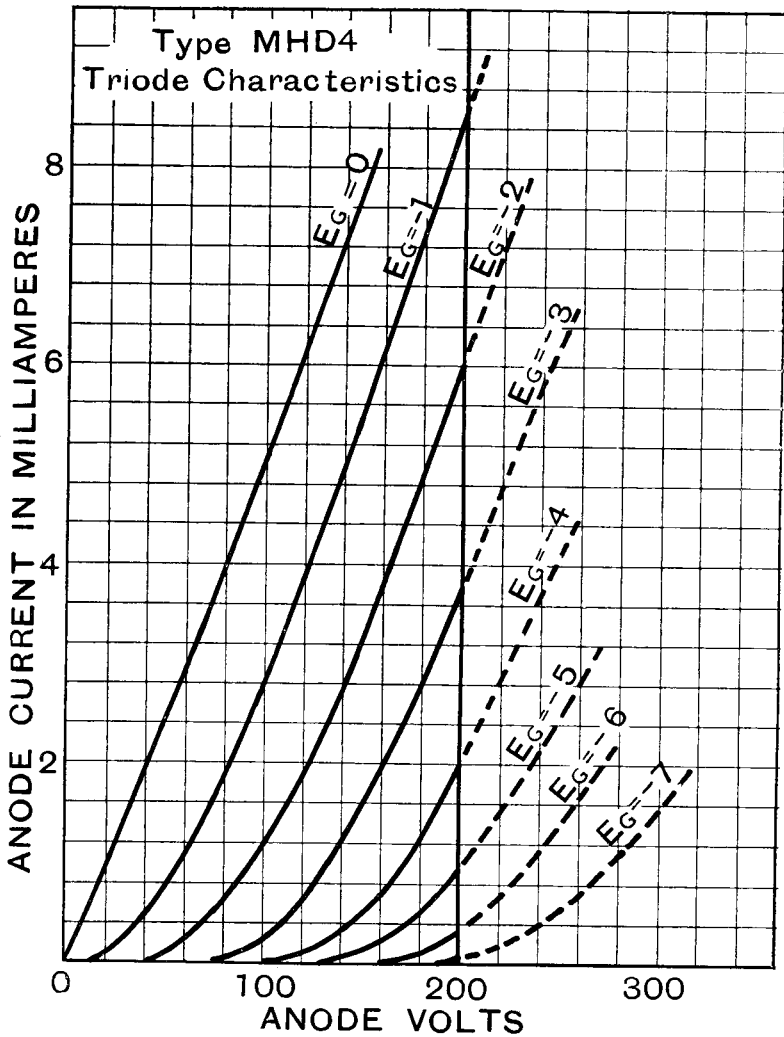

CHARACTERISTIC CURVES OF AVERAGE VALVE.

Osram Valves

Made in England



Maximum Dimensions :
Overall length (including pins)
112 m/m.
Diameter of bulb
45 m/m.

TYPE MH4 DETECTOR AND AMPLIFYING TRIODE

With Indirectly Heated Cathode
(For operation from A.C. Mains).

The OSRAM MH4 is a three-electrode valve of the indirectly Heated Cathode type recommended for use as a Detector, Amplifier, or Oscillator in A.C. Receivers designed for it. The features of high Amplification Factor combined with relatively high Mutual Conductance enable a high stage gain to be obtained. A further feature of the valve is its non-microphonic property which is of particular importance when applied to the Detector stage.

CHARACTERISTICS.

Heater Volts	4.0
Heater Current	1.0 amp. approx.
			Max.				
Anode Volts	250	200	150	100	
Grid Volts (in Amplifier)	-3	-2	-1.5	
Anode Current average	4.7 m.a.	4.2 m.a.	2.5 m.a.	
Amplification Factor	
Impedance	{ 40 11,100 ohms. 3.6 ma/volt measured at grid volts 0.
Mutual Conductance	
Automatic Grid Bias Resistance (in amplifier)							700 ohms.
Optimum Load Resistance	50,000 ohms.
Anode Dissipation	2.5 watts max.
Interelectrode Capacities :—							
Grid—Anode (others earthed)	5.7 micro-microfarad approx.
Anode—other electrodes	6.5 " " "
Grid—other electrodes	7.0 " " "

(Taken with metallised bulb)

For prices see
pages 126-129.

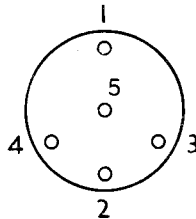

View of underside of base

BASE, 5-PIN.

- 1: Anode
- 2: Grid
- 3: Heater
- 4: Heater
- 5: Cathode and Metallising

Type MH4 has a carbonised bulb and can be supplied metallised if required.

TYPE MH4

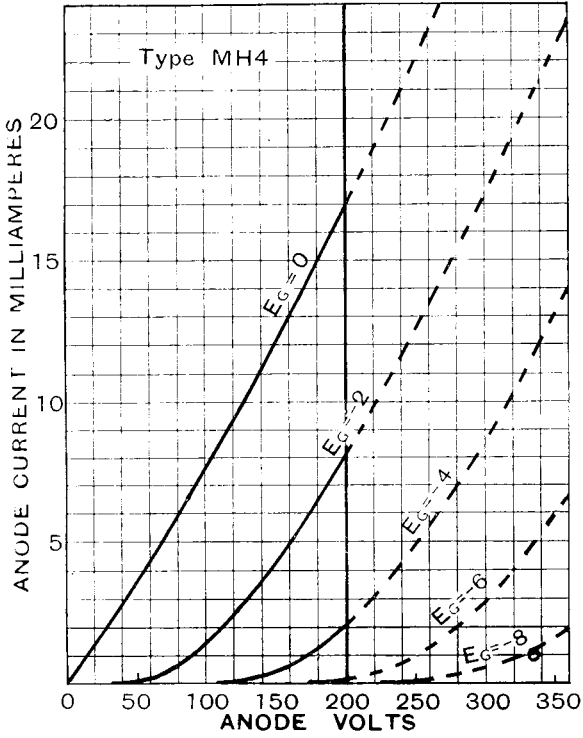

CHARACTERISTIC CURVES
OF
AVERAGE VALVE.

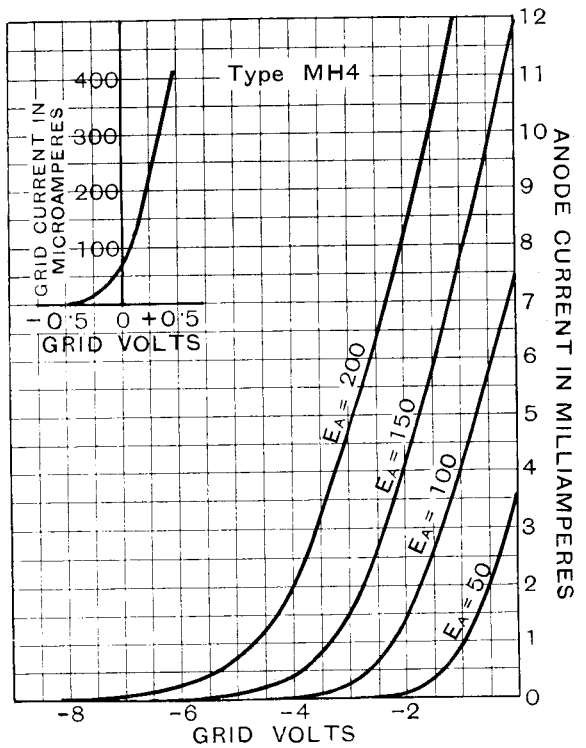

Osram Valves

Made in England



Maximum Dimensions :

Overall length (including pins)
120 m/m.

Diameter of bulb 41.5 m/m.

TYPE H42 DETECTOR AND AMPLIFYING TRIODE

With Indirectly Heated Cathode
(For operation from A.C. Mains).

The OSRAM H42 is an Indirectly Heated Cathode Triode for use in the early stages of an audio frequency amplifier, or as a Detector. Due to its high Amplification Factor it is particularly suitable for use in a resistance capacity coupled circuit. The high sensitivity of the valve enables it fully to load a PX4 valve operating at its maximum working condition from an input of 0.5 volt.

In the H42 the grid is taken to a top cap connection which materially reduces the input capacity and prevents severe attenuation of the higher frequencies.

A further feature of the type is its non-microphonic property which is of particular importance when applied to the Detector or early stages in an amplifier.

CHARACTERISTICS.

Heater Volts	4.0			
Heater Current	0.6 amp. approx.			
	Max.			
Anode Volts	250	200	150	100
Grid Volts	-2	-1.6	-1.2	-0.8
Anode Current average	1.0	0.9	0.8	0.75 mA
Amplification Factor	100			
Impedance	66,000 ohms.			
Mutual Conductance	1.5 mA/volt			1.7 mA/volt (at Eg = 0.)
Automatic Bias Resistance	2,000 ohms.			
Optimum Load Resistance	200,000 ohms.			

Interelectrode Capacities :

Grid to Anode (others earthed)	3.0 m.mfd. approx.
Anode to other Electrodes	5.3 " "
Grid to Cathode	2.6 " "

For prices see
pages 126-129.

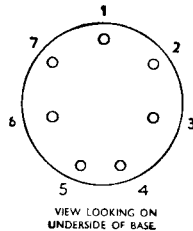

BASE, 7-pin.

- Pin 1 : —
 - 2 : —
 - 3 : —
 - 4 : Heater
 - 5 : Heater
 - 6 : Cathode
 - 7 : Anode
- Top Cap : Grid

Type H42 has a carbonised bulb and is supplied unmetallised only.

TYPE H42

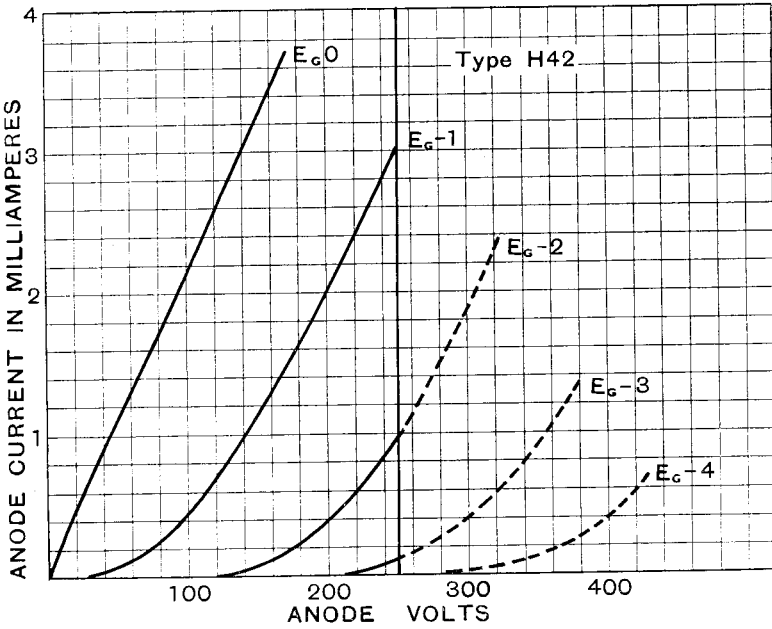
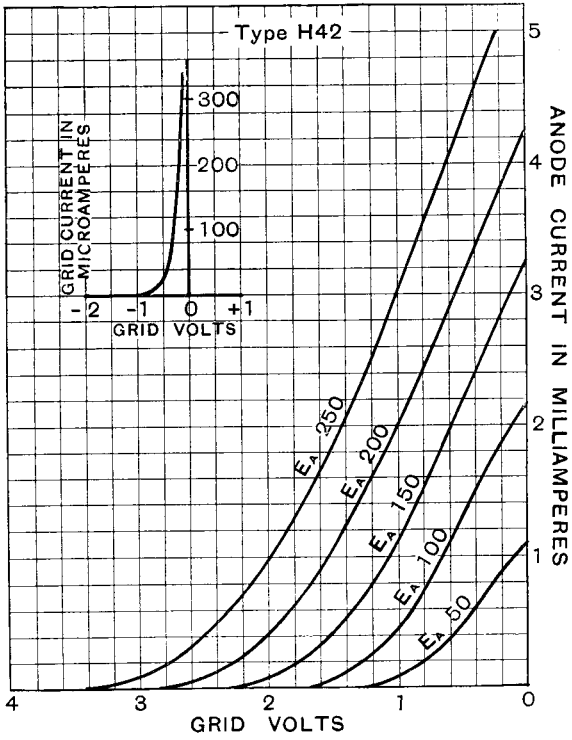

CHARACTERISTIC CURVES OF AVERAGE VALVE.

Osram Valves

Made in England.



Maximum Dimensions :
Overall length (including pins)
112 m/m.

Diameter of bulb
45 m/m.

TYPE MHL4

MEDIUM IMPEDANCE TRIODE.

With Indirectly Heated Cathode.

(For operation from A.C. Mains).

The OSRAM MHL4 is an Indirectly Heated Cathode Valve suitable for filament heating through a transformer of suitable ratio from A.C. supply mains.

The valve provides characteristics intermediate between the High Amplification Factor and the very Low Impedance types. It is a very useful valve for circuits in which a high degree of voltage amplification combined with moderately low value of impedance is required, such as the stage preceding an L.F. transformer designed for a valve of about 8,000 ohms.

CHARACTERISTICS.

Heater Volts	4.0		
Heater Current	1.0 amp. approx.		
	Max.		
Anode Volts	250	150	100
Grid Volts	-6	-4	-3
(for operation in amplifier)			
Anode Current average	7.0 ma.	3.5 ma.	2.5 ma.
Amplification Factor	20
Impedance	} 8,000 ohms. 2.5 ma./v.
Mutual Conductance	

(measured at grid volts 0)

For prices see
pages 126-129.

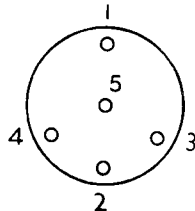

View looking on
underside of base.

BASE, 5-pin.

- 1: Anode
- 2: Grid
- 3: Heater
- 4: Heater
- 5: Cathode and Metallising

Type MHL4 has a carbonised bulb and can be supplied metallised if required.

TYPE MHL4

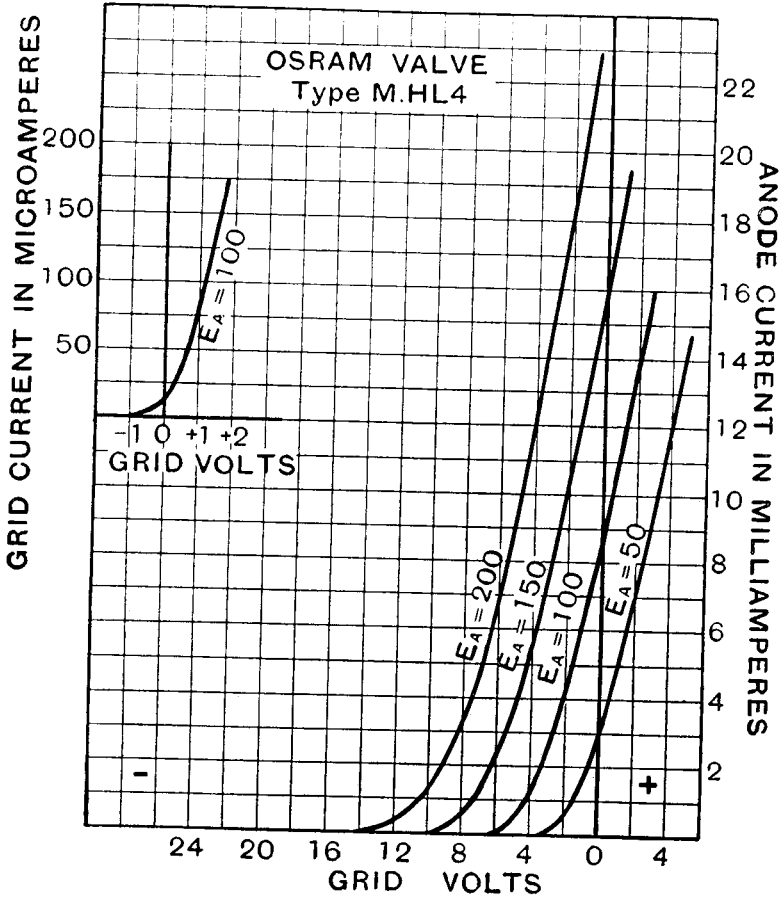

CHARACTERISTIC CURVES OF AVERAGE VALVE.

Osram Valves

Made in England.



Maximum Dimensions :
 Overall length (including pins)
 130 m/m.
 Diameter of bulb 51 m/m.

TYPE ML4

L.F. AMPLIFYING TRIODE

With Indirectly Heated Cathode

(For operation from A.C. mains).

The OSRAM ML4 is an Indirectly Heated Cathode Triode suitable for use :

1. In the early stage of receivers or amplifiers fitted with a large Power valve in the output stage.
2. As a low gain Detector.
3. As a separate Oscillator in superhet. receivers.

The filament may be fed from the A.C. Main supply through a suitable transformer. The high mutual conductance of the ML4, coupled with its low Impedance, ensures a considerable stage gain and, if desired, the valve can be allowed to dissipate a power equivalent to 5 watts.

CHARACTERISTICS.

Heater Volts	4.0			
Heater Current	1.0 amp. approx.	
		Max.			
Anode Volts	250	200	150	100
Grid Volts	-11	-8	-6
Anode Current average	16 m.a.	13 m.a.	7 m.a.
Amplification Factor	12
Impedance	} 2,860 ohms. 4.2 ma/volt measur: at grid volts 0.
Mutual Conductance	
Automatic Bias Resistance	650 ohms.		
Optimum Load Resistance	7,000 ohms.		
Anode Dissipation	5 watts max.		
Interelectrode Capacities :—					
Grid—Anode (others earthed)	6.3 micro-microfarad approx.		
Anode—other electrodes	4.5 " " "		
Grid—other electrodes	7.2 " " "		

For prices see
 pages 126-129.

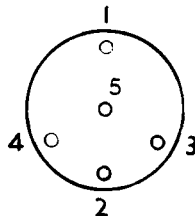

BASE, 5-PIN

- 1: Anode.
- 2: Grid.
- 3: Heater.
- 4: Heater.
- 5: Cathode.

TYPE ML4

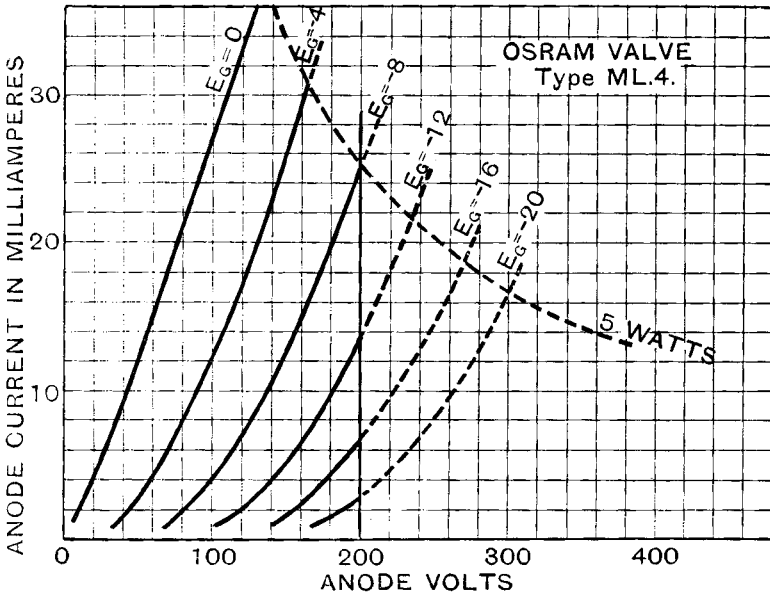
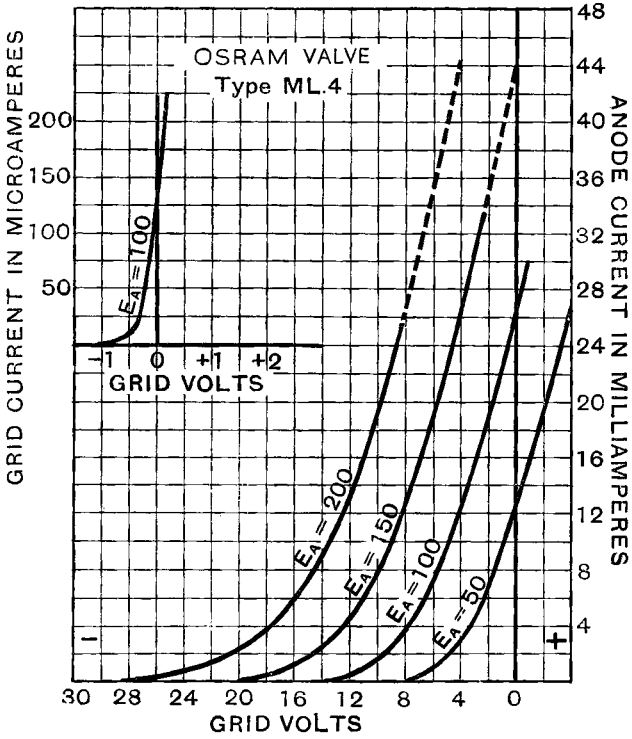

CHARACTERISTIC CURVES OF AVERAGE VALVE.



Maximum Dimensions :
 Overall length (including pins)
 135 m/m.
 Diameter of bulb 58 m/m.

Osram Valves

Made in England.

TYPE MPT4 PENTODE POWER AMPLIFYING VALVE With Indirectly Heated Cathode (For operation from A.C. mains).

The OSRAM MPT4 is a Power Amplifying Pentode for use in the output stage of A.C. Receivers. It is capable of giving a large power output with a relatively small input signal voltage. For this reason the MPT4 should be restricted to use in sets using only one stage of Low Frequency Amplification before it.

CHARACTERISTICS.

Heater Volts	4.0
Heater Current	1.0 amp. approx.
	Max.
Anode Volts	250
Screen Grid Volts	200
Amplification Factor
Impedance
Mutual Conductance
	{ 100
	{ 33,000 ohms.
	{ 3.0 ma/volt measured
	{ at Anode Volts 100,
	{ Screen Grid Volts 100,
	{ Grid Volts 0.
Negative Grid Bias	10 volts approx.
Automatic Bias Resistance	270 ohms.
Anode Current average	32 m.a.
Screen Current average	6 m.a.
Optimum Load Resistance	8,000 ohms.
Anode Dissipation	8 watts max.

For prices see pages 126-129.

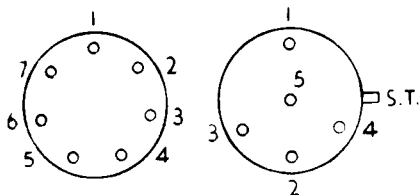

Views looking on underside of valve base.

Type MPT4 has a carbonised bulb.

TYPICAL OPERATING CONDITIONS.

It is recommended that a filter circuit be employed, as shown in the diagram, in order to prevent over-emphasis of the higher audio frequencies. The screen voltage should be obtained by connecting the screen grid to the H.T. supply through a suitable resistance, and a non-inductive condenser connected from screen grid to cathode to provide a de-coupling circuit.

The total resistance in this grid circuit should not exceed 500,000 ohms, and full automatic grid bias is recommended.

Care should be taken that the anode circuit is never broken while the screen voltage is applied.

ALTERNATIVE BASES.

7-PIN.	5-PIN.
1: —	1: Anode
2: Grid	2: Grid
3: Screen Grid	3: Heater
4: Heater	4: Heater
5: Heater	5: Cathode
6: Cathode	Side Terminal: Screen Grid.
7: Anode	

TYPE MPT4

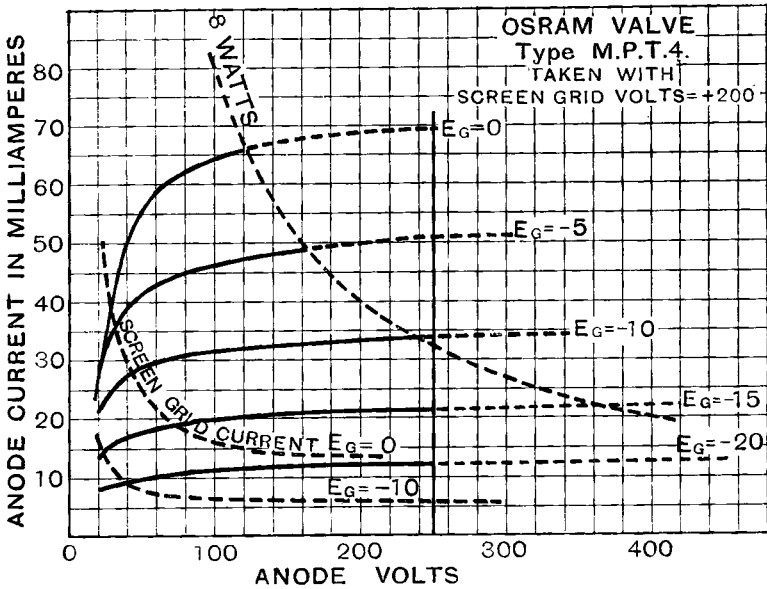
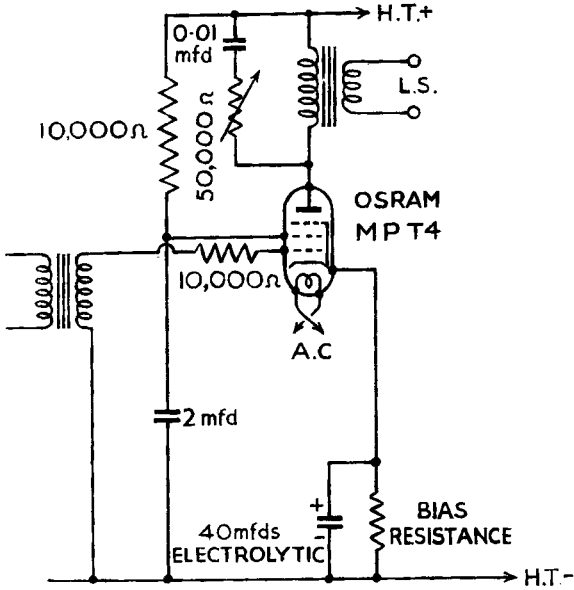

CHARACTERISTIC CURVES OF AVERAGE VALVE.

Osram Valves

Made in England.



Maximum Dimensions :
Overall length (including pins)
145 m/m.

Diameter of bulb
57 m/m.

TYPE N41

PENTODE POWER AMPLIFYING VALVE
with Indirectly Heated Cathode.
(For operation from A.C. Mains).

The OSRAM N41 is an Indirectly Heated Cathode Pentode Valve for use in the output stage of radio receivers and L.F. amplifiers.

The characteristic of the N41 is its high value of mutual conductance which results in extreme sensitivity. Thus the valve is suitable for the output stage of a receiver employing a diode detector directly coupled to its grid. Alternatively, the N41 is suitable for use in a resistance coupled L.F. amplifier where very high gain is desired.

CHARACTERISTICS.

Heater Volts	4.0
Heater Current	2.0 amps. approx.
									Max.
Anode Volts	250
Screen Volts	250
Grid Volts	-3.5
Anode Current average	32 m.a.
Screen Current average	8 m.a.
Anode Dissipation	8 watts
Mutual Conductance	10.0 ma/volt
Optimum Load Resistance	7,800 ohms.
Automatic Bias Resistance	90 ohms.
Interelectrode Capacities :—									
Grid—Anode	1.44 micro-microfarad approx.
Anode—other electrodes	20.27 " " "
Grid—other electrodes	11.1 " " "

For prices see
pages 126-129.

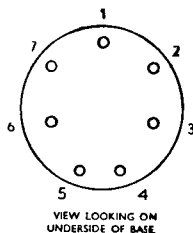

BASE, 7-PIN.

- 1: —
- 2: Grid
- 3: Screen
- 4: Heater
- 5: Heater
- 6: Cathode
- 7: Anode

Type N41 has a carbonised bulb.

TYPICAL OPERATING CONDITIONS.

Owing to the high sensitivity, a grid stopping resistance is recommended, but the total resistance in the grid circuit should in no case exceed 500,000 ohms.

Type N41 should only be employed with full automatic grid bias.

TYPE N41

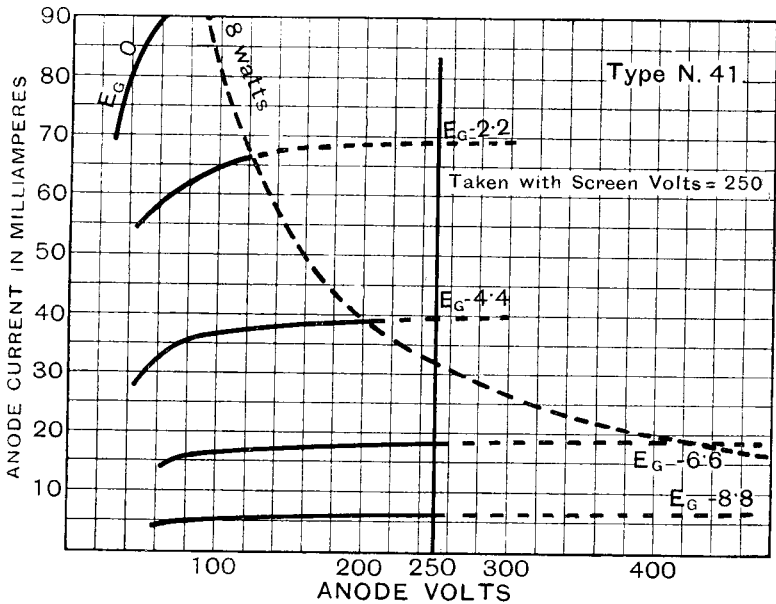
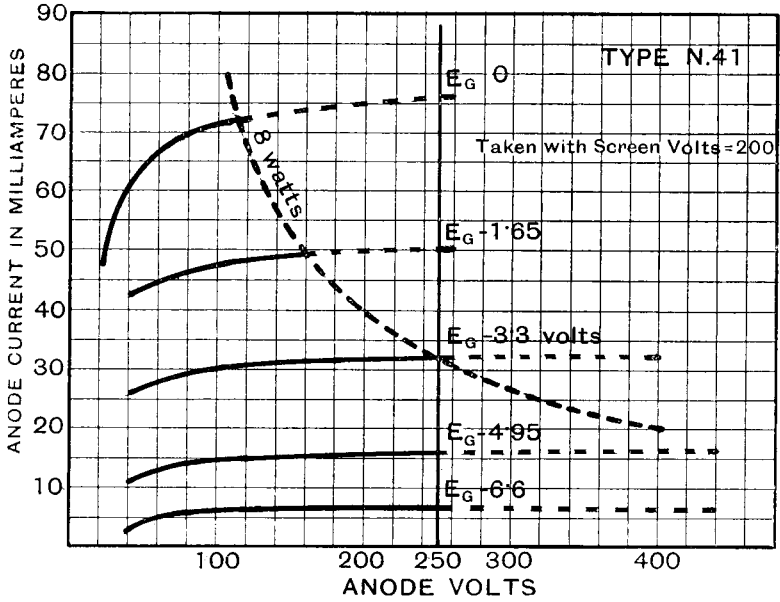

CHARACTERISTIC CURVES OF AVERAGE VALVE.

Osram Valves

Made in England



Maximum Dimensions :
Overall length (including pins)
115 m/m.
Diameter of bulb 45 m/m.

TYPE N42 POWER AMPLIFYING PENTODE With Indirectly Heated Cathode (For operation from A.C. Mains).

The OSRAM N42 is a Pentode suitable for use in the output stage of A.C. Receivers. It is capable of providing a large pure undistorted power output with a relatively small input signal voltage. For this reason type N42 should be restricted to use in sets using only one stage of Low Frequency Amplification before it. In a Super-heterodyne Receiver the N42 is suitable for operation following either a Double Diode-Triode of the DH42 type or Triode of the H42 type, preceded by Diode Detection.

CHARACTERISTICS.

Heater Volts	4.0
Heater Current	1.0 amp. approx.
	Max.
Anode Volts	250
Screen Grid Volts	250
Mutual Conductance	2.5 ma/volt
Negative Grid Bias	-16.5 volts approx.
Automatic Bias Resistance	420 ohms.
Anode Current average	34.0 m.a.
Screen Current average	5.5 m.a.
Optimum Load Resistance	7,000 ohms.
Anode Dissipation	8 watts max

For prices see
pages 126-129.

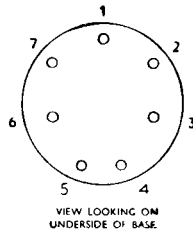

VIEW LOOKING ON
UNDERSIDE OF BASE

BASE, 7-pin.

- Pin 1: —
2: Grid
3: Screen Grid
4: Heater
5: Heater
6: Cathode
7: Anode

Type N42 has a carbonised bulb.

OPERATING CONDITIONS.

To reduce any tendency to oscillation, a grid stopper of 1,000 ohms or an anode stopper of 100 ohms can be inserted in circuit at the valve holder connections. When employed in a resistance coupled Amplifier preceded by an H42 valve, full output will be obtained from the N42 with an input of 0.15 v. R.M.S. to the H42.

Two N42 valves may be operated in push pull in which case a common bias resistance of 250 ohms may be used, and anode-to-anode load resistance of 11,000 ohms is recommended.

TYPE N42

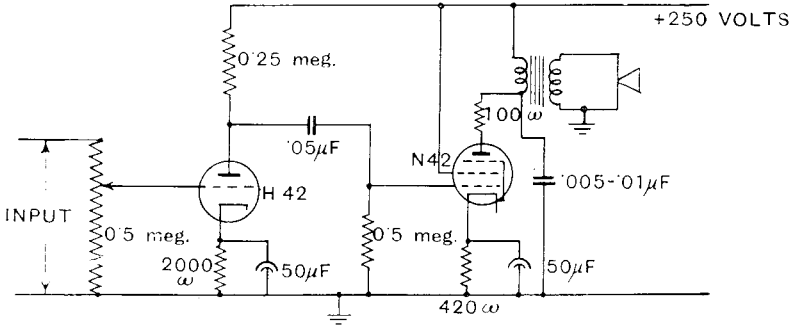

TYPICAL RESISTANCE COUPLED AMPLIFIER

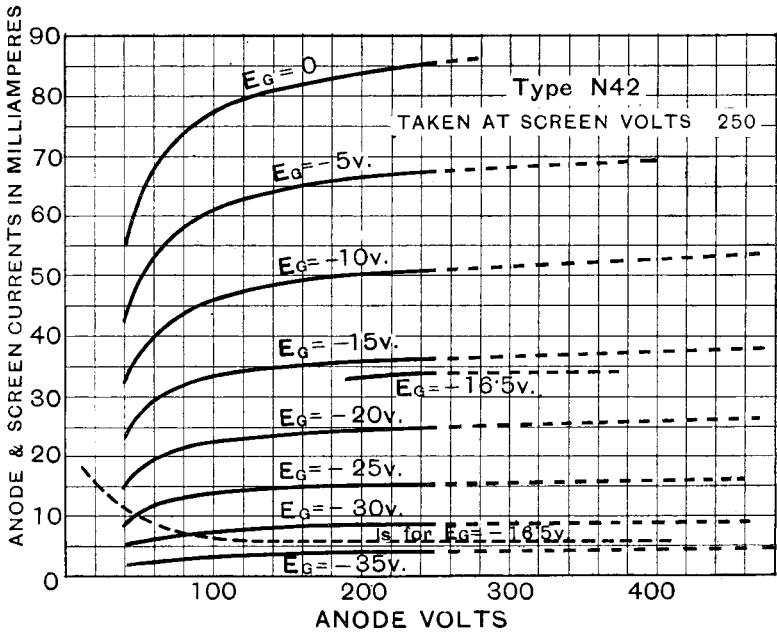

CHARACTERISTIC CURVES OF AVERAGE VALVE.



Osram Valves

Made in England

TYPE DN41

DOUBLE DIODE-OUTPUT PENTODE

With Indirectly Heated Cathode.
(For operation from A.C. mains).

The OSRAM DN41 is a power amplifier pentode and a double diode system mounted in the same bulb, with cathodes connected to a common cathode pin in the valve base. A metal plate connected to the pentode cathode is interposed between the two sections to act as an electrostatic screen.

The pentode section develops a large power output, and owing to the high mutual conductance figure, is very sensitive. As a result of this high sensitivity it can be fed directly from the diode section.

Maximum Dimensions :
Overall length (including pins)
152 m/m.
Diameter of bulb
57 m/m.

CHARACTERISTICS.

Heater Volts	4.0
Heater Current	2.3 amps. approx.
Pentode Characteristics :—	Max.
Anode Volts	250
Screen Volts	250
Grid Volts	-3.5
Anode Current average	32 ma.
Screen Current average	8 ma.
Anode Dissipation	8 watts.
Mutual Conductance	10.0 ma/volt.
Optimum Load Resistance	7,800 ohms.
Automatic Bias Resistance	90 ohms.

Diode Characteristics :—With 0.25 megohm diode load resistance.

H.F. Input Volts Modulated 30%	L.F. Output Peak Volts.
1	0.2
2	0.42
4	0.98
8	2.0
16	4.6

Interelectrode Capacities :—

Each diode anode—triode grid	0.05 micro-microfarad approx.
Both diodes—Earth	15.0 " " "
Grid—Anode	0.75 " " "
Anode—other electrodes	15.7 " " "
Grid—other electrodes	18.5 " " "

For prices see
pages 126-129.

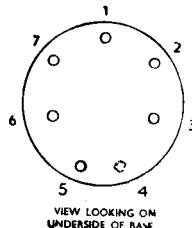

VIEW LOOKING ON
UNDERSIDE OF BASE

BASE, 7-PIN.

- 1 : Diode
- 2 : Anode
- 3 : Diode
- 4 : Heater
- 5 : Heater
- 6 : Cathode
- 7 : Screen Grid

Top Cap : Grid

Type DN41 has a carbonised bulb.

TYPE DN41

TYPICAL OPERATING CONDITIONS.

To make full use of the DN41 valve one diode will normally be operated as a detector feeding into the pentode grid while the other diode produces delayed A.V.C.

In operating the pentode section special precautions are necessary in view of its high sensitivity. The wiring and arrangement of the circuit should be such as to keep the capacity between input and output circuits as low as possible. A grid stopper resistance of 100,000 ohms or anode stopper of 100 ohms should be employed. It is recommended that in no case should the total resistance in the grid circuit exceed 500,000 ohms. In every case full automatic bias only should be used.

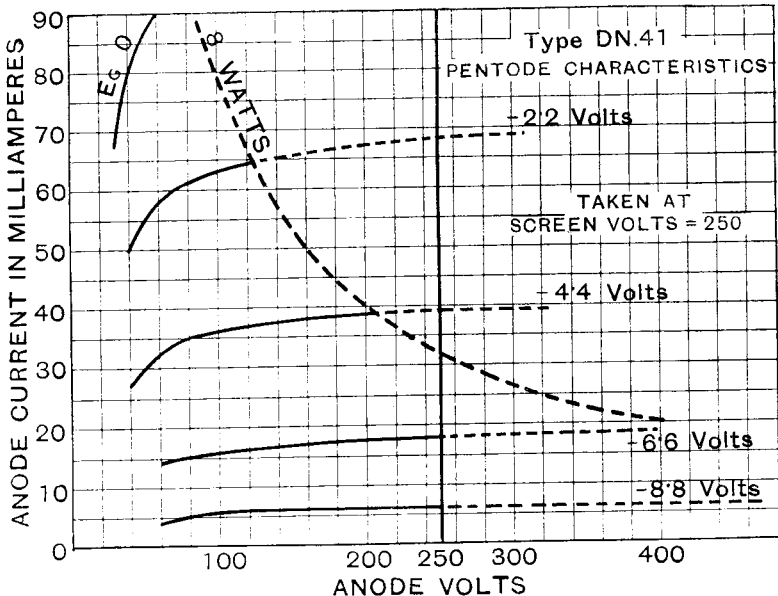
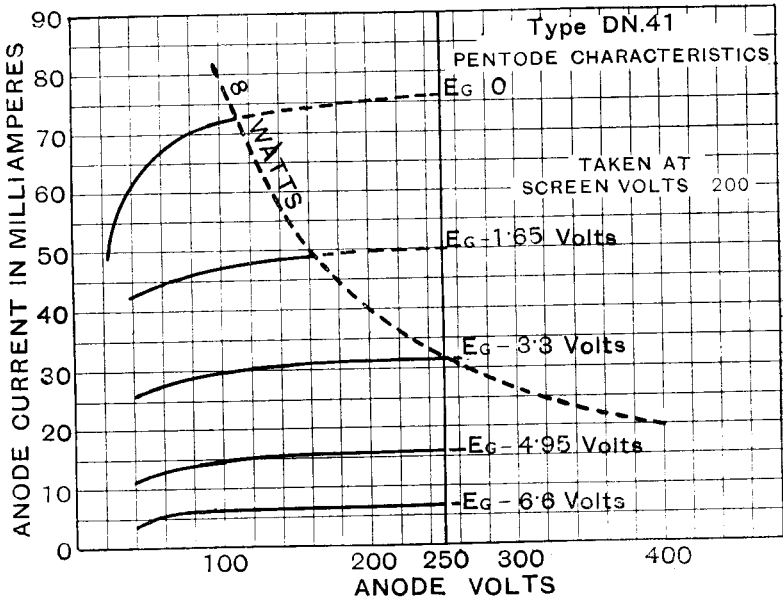

CHARACTERISTIC CURVES OF AVERAGE VALVE.

Osram Valves

Made in England.

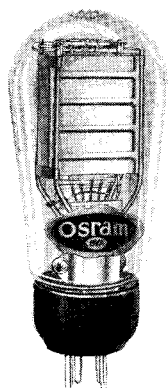

Maximum Dimensions :
Overall length (including pins)
150 m/m.

Diameter of bulb
61 m/m.

TYPE PX4

POWER AMPLIFYING TRIODE

With Directly Heated Filament.

The OSRAM PX4 is a Directly Heated Power Triode for the output stage of receivers and amplifiers where a considerable undistorted power output is required with a maximum anode voltage of 250. For this purpose the valve has exceptionally good characteristics.

The filament may be heated from A.C. through a suitable step-down transformer. If the maximum A.C. power is not required economy can be obtained by operating at a reduced anode voltage and a dissipation limited to 5 watts.

CHARACTERISTICS.

Filament Volts	4.0		
Filament Current	1.0 amp.		
	Max.		
Anode Volts	250	200	200
Grid Volts	-32	-25	-28
Anode Current average	48 ma	40 ma	25 ma
Anode Dissipation	12 watts	8 w	5 w
Amplification Factor
Impedance
Mutual Conductance
			$\left. \begin{array}{l} 3 \\ 830 \text{ ohms.} \\ 6.0 \text{ ma/v} \end{array} \right\}$
			(measured at Anode Volts 100, Grid Volts 0.)
Optimum Load Resistance	2,400 ohms	..	4,500 ohms
Automatic Bias Resistance	700 ohms	..	1,200 ohms
			(A.C. filament heating)

Interelectrode Capacities :—

Grid—Anode	13.3 micro-microfarads approx.
Anode—Filament	5.8 " " "
Grid—Filament	9.3 " " "

For prices see
pages 126-129.

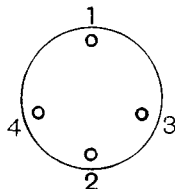

View looking on
underside of base

BASE, 4-PIN.

- 1: Anode
- 2: Grid
- 3: Filament
- 4: Filament

TYPICAL OPERATING CONDITIONS.

Automatic grid bias is recommended, the bias resistance being taken to the electrical centre of the filament or L.T. transformer secondary in order to minimise hum. Care should be taken to switch off the power supply when inserting or removing the valve from its socket, or when any adjustments are made to the circuit such as alteration to grid bias. If two valves are employed in push-pull or parallel, similar auto bias circuits and oscillation stoppers should be applied to each individual valve.

TYPE PX4

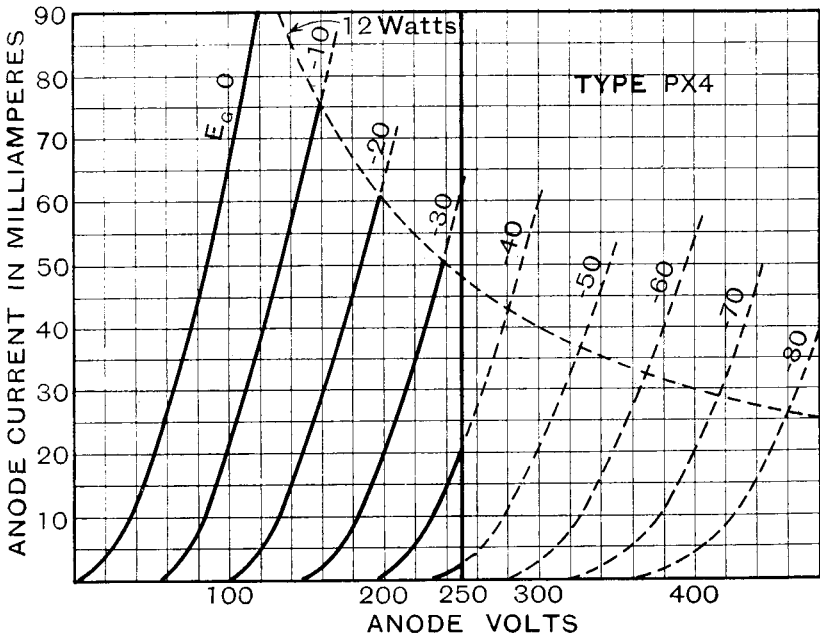
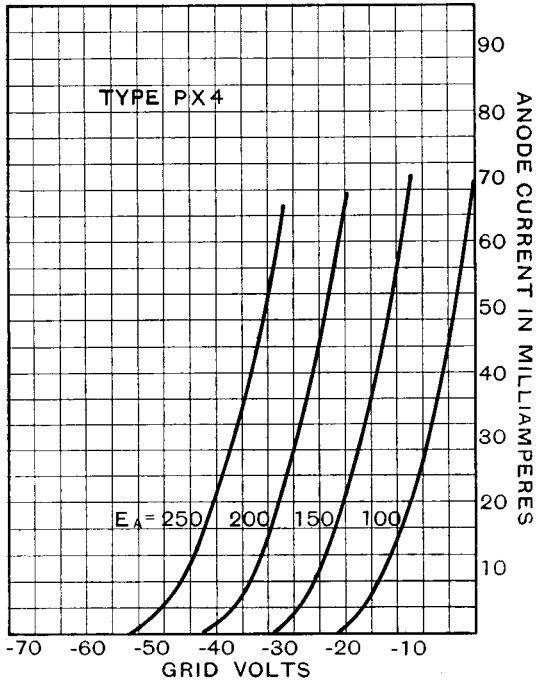

CHARACTERISTIC CURVES OF AVERAGE VALVE.

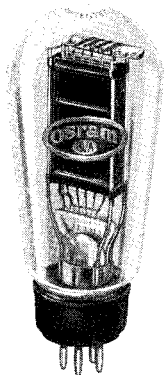

Osram Valves

Made in England.

TYPE PX25

POWER AMPLIFYING TRIODE

With Directly Heated Filament.

The OSRAM PX25 is a Power Amplifying valve of extremely high efficiency designed with a large power handling capacity to supply considerable undistorted volume.

It is intended for use in the last stage of Low Frequency Amplifiers, where provision is made for adequate high tension supply. When operating the PX25 Valve, arrangements should be made for sufficient air circulation to prevent over-heating.

CHARACTERISTICS.

Filament Volts	4.0			
Filament Current	2.0 amp. approx.			
	Max.			
Anode Volts	400	350	300	
Grid Volts	-31	-26	-21	
Anode Current average	62.5 ma	57 ma	44 ma	
Anode Dissipation	25 watts	20 watts	13 watts	
Amplification Factor	9.5			
Impedance	1,265 ohms			
Mutual Conductance	8.0 ma/volt			7.5 ma/volt
Automatic Bias Resistance	530 ohms			(measured at anode volts 100, grid volts 0).
Optimum Load Resistance	3,200 ohms			

Interelectrode Capacities :

Grid—Anode	14.8 micro-microfarad approx.
Anode—Filament	8.3 " " "
Grid—Filament	11.4 " " "

For prices see
pages 126-129,

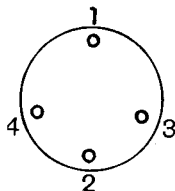

BASE, 4-PIN.

- 1 : Anode
- 2 : Grid
- 3 : Filament
- 4 : Filament

View looking on
underside of base.

TYPICAL OPERATING CONDITIONS.

Automatic grid bias should be used for each valve, the bias resistance being taken to the electrical centre of the filament or L.T. transformer secondary in order to minimise hum. If two valves are employed in push-pull or parallel, similar auto bias circuits and oscillation stoppers should be applied to each individual valve.

Care should be taken to switch off the power supply when inserting or removing the valve from its socket, or when any adjustments are made to the circuit.

TYPE PX25

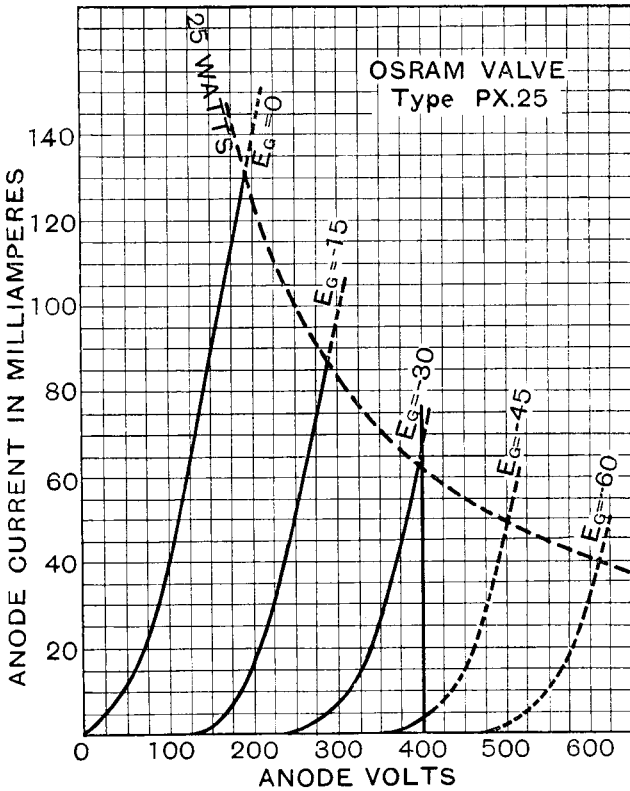
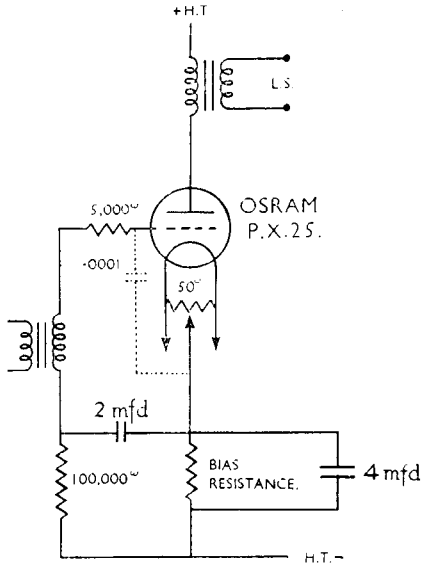

(Taken with D.C. filament heating)
CHARACTERISTIC CURVES OF AVERAGE VALVE.

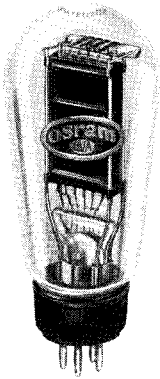

Osram Valves

Made in England.

TYPE PX25A POWER AMPLIFYING TRIODE

With Directly Heated Filament.

The OSRAM PX25A is a Power Amplifying Triode, designed with a large power handling capacity to supply considerable undistorted volume.

It is intended for use in the last stage of Low Frequency Amplifiers, particularly in low impedance loading push-pull circuits, where provision is made for adequate high tension supply. Arrangements should be made for sufficient air circulation to prevent over-heating.

Maximum Dimensions :
Overall length (including pins)
160 m/m.
Diameter of bulb
66 m/m.

CHARACTERISTICS.

Filament Volts	4.0
Filament Current	2.0 amps. approx.
	Max.
Anode Volts	400 350 300
Grid Volts	-100 -85 -75
Anode Current average	62.5 ma. 60 ma. 50 ma.
Anode Dissipation	25 w. 21 w. 15 w.
Amplification Factor	{ 3.2 } 4
Impedance	{ 860 } 580 ohms.
Mutual Conductance	{ 3.7 } 6.9 ma/volt.
	measured at
	Anode Volts 400
	Anode Current 62.5 m.a.
Optimum Load Resistance	4,500 ohms. } for single
Automatic Bias Resistance	1,600 ohms. } valve
	measured at
	Anode Volts 100.
	Grid Volts 0.
	2,800 ohms. (anode
	to anode in low
	loading push pull)

Interelectrode Capacities :—

Grid—Anode	13.0 micro-microfarads approx.
Anode—Filament	6.5 " " "
Grid—Filament	10.0 " " "

For prices see
pages 126-129.

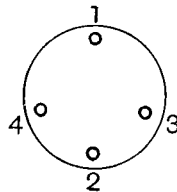

BASE, 4-PIN.

- 1: Anode
- 2: Grid
- 3: Filament
- 4: Filament

View looking on underside of base.

TYPICAL OPERATING CONDITIONS.

Under Class "A" conditions automatic grid bias is strongly recommended.

A common application of the PX25A valve is however the use of two such valves in a push-pull circuit involving low anode load impedance.

By the use of a pair of PX25A Valves in a push-pull circuit with low impedance loads, it is possible to obtain an undistorted power output up to 32 watts per pair. Complete operating details are obtainable on application.

Care should be taken to switch off the power supply when inserting or removing the valve from its socket or when any adjustments are made to the circuit, such as alteration to grid bias.

TYPE PX25A

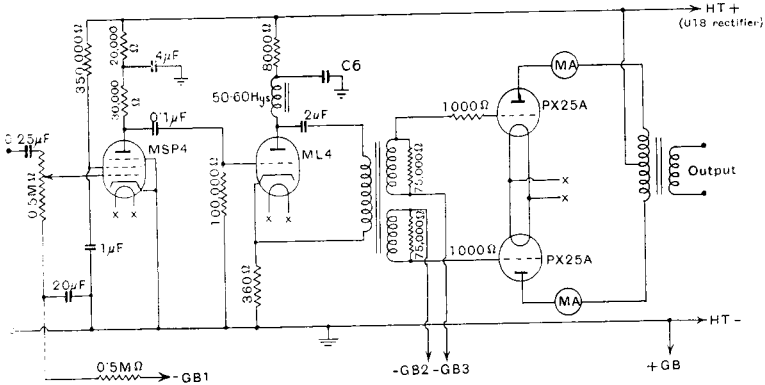

- GB1 1.5v.
 - GB2 } adjusted to give 57 m.a. each PX25A valve at anode voltage 440 (no load)
 - GB3 }
- Grid bias may conveniently be derived from a U10 rectifier & potentiometer network (total pot'r resistance not to exceed 25,000 ohms)

TYPICAL CIRCUIT FOR 32 WATT AMPLIFIER.

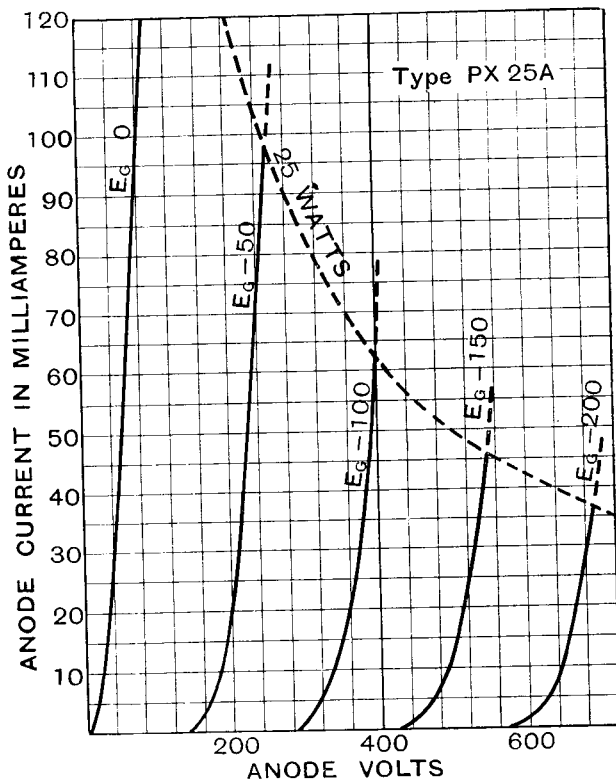

(Taken with D.C. filament heating).

CHARACTERISTIC CURVES OF AVERAGE VALVE.

Osram Valves

Made in England.

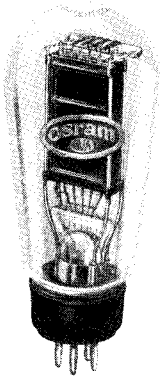

Maximum Dimensions :
Overall length (including pins) 160 m/m.
Diameter of bulb 66 m/m.

TYPE DA30 POWER AMPLIFYING TRIODE, With Directly Heated Filament.

The OSRAM DA30 is a Power Amplifying Triode for use in the output stage of amplifiers where a considerable undistorted power is required without recourse to the application of high H.T. voltages. The principal application of the DA30 is to push-pull amplifiers, in which a pair of valves are employed under conditions which allow for a considerable undistorted power output by adjustment of the anode to anode load impedance to a lower value than the normal figure for Class "A" operation.

CHARACTERISTICS.

Filament Volts	4.0
Filament Current	2.0 amps. approx.
Anode Volts	500 max.
Grid Volts	-134 approx.
Anode Current average	60 m.a.
Anode Dissipation	30 watts. max.
Amplification Factor	3.5
Impedance	910 ohms.
Mutual Conductance	3.85 ma/volt (measured at Anode Volts 500, Anode current 60 ma)
	4 } 580 ohms. (measured at Anode Volts 100, Grid Volts 0.)
Optimum Load Resistance	6000 ohms. } for single valve
Automatic Bias Resistance	2300 ohms. } anode in low loading push pull)
Interelectrode Capacities :	
Grid-Anode	13.0 micro-microfarads approx.
Anode-Filament	6.5 " " "
Grid-Filament	10.0 " " "

For prices see pages 126-129.

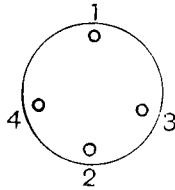

View looking on underside of base

BASE. 4-pin.

1. Anode.
2. Grid.
3. Filament.
4. Filament.

TYPICAL OPERATING CONDITIONS.

Under Class "A" conditions automatic grid bias is strongly recommended.

A common application of the DA30 valve is however the use of two such valves in a push-pull circuit involving low anode load impedance.

By the use of a pair of DA30 Valves in a push-pull circuit with low impedance loads, it is possible to obtain an undistorted power output up to 45 watts per pair. Complete operating details are obtainable on application.

Care should be taken to switch off the power supply when inserting or removing the valve from its socket or when any adjustments are made to the circuit, such as alteration to grid bias.

TYPE DA30

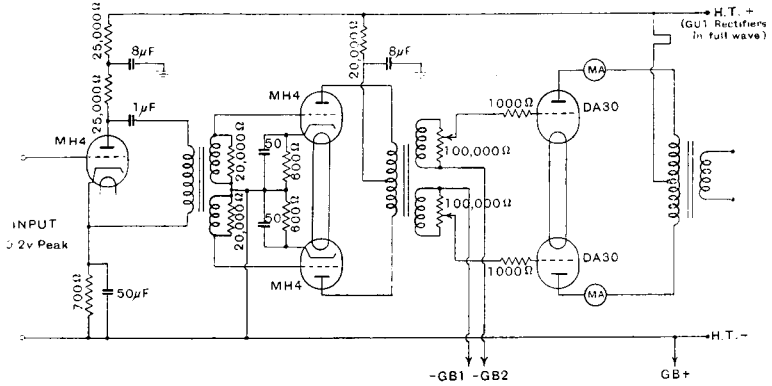

-GB1 } adjusted to give 50 m.a. each DA30 valve at anode voltage 500 (no load)
 -GB2 }
 Grid bias may conveniently be derived from a U10 Rectifier.

TYPICAL CIRCUIT FOR 45 WATT AMPLIFIER.

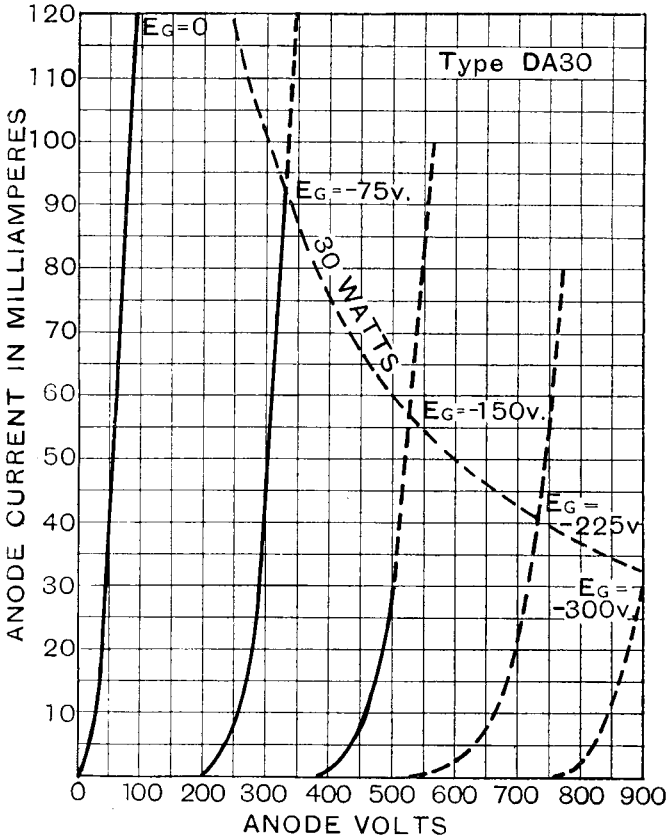

(Taken with D.C. filament heating)

CHARACTERISTIC CURVES OF AVERAGE VALVE.

Osram Valves

Made in England.



Maximum Dimensions :
Overall length (including pins)
 290 m/m.
Diameter of bulb
 90 m/m.

TYPE DA100 POWER AMPLIFYING TRIODE

With Directly Heated Filament.

The OSRAM DA100 is a Power Amplifying Triode with Directly Heated Filament, suitable for use in the output stage of an amplifier. The valve is designed for adequate power output and reliable service, and used under correct conditions will provide an exceedingly good working life.

The DA100 Valve is also suitable for operation in push-pull circuits in which a greatly increased power output is obtainable with suitable circuit arrangement.

CHARACTERISTICS.

Filament Volts	6.0
Filament Current	2.7 amps. approx.
Anode Volts	1,000 max.
Grid Volts	-146 approx.
Anode Current average	100 m.a max.
Anode Dissipation	100 watts max.
Amplification Factor	5.5
Impedance	1,410 ohms.
Mutual Conductance	3.9 ma/volt
	(measured at anode volts 1,000, anode dissipation 100 watts).
Automatic Bias Resistance with A.C. filament heating	1,490 ohms.
Optimum Load Resistance	6,700 ohms for single valve 8,000 ohms (anode to anode) in low loading push-pull
A.C. Power Output for 5% Second Harmonic Distortion	30 watts approx. for single valve 90 watts approx. in low loading push pull (without positive grid drive).
Interelectrode Capacities :-	
Grid-Anode	16.0 micro- microfarads approx.
Anode-Filaments	9.0 " " "
Grid-Filament	15.0 " " "

For prices see
pages 126-129.

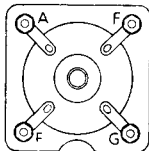

BASE, Special 4-pin

A: Anode
 F: Filament
 G: Grid
 F: Filament

View looking on
underside of base.

TYPICAL OPERATING CONDITIONS.

Under "Class A" conditions automatic grid bias is strongly recommended. A common application of the DA100 valve is the use of two of such valves in a push pull circuit involving low anode Load Impedance.

By the use of a pair of DA100 valves in a push pull circuit with low impedance loads, it is possible to obtain a greatly increased undistorted power output. Provision should be made for ample air circulation to prevent overheating and care taken to switch off the power supply when any circuit adjustments are made.

Type DA100 is also suitable for positive grid drive "Class B" circuit under suitable conditions of operation.

TYPE DA100

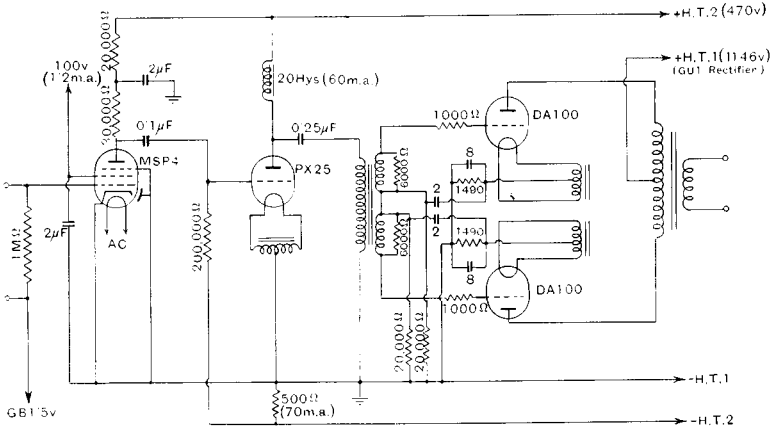

TYPICAL CIRCUIT FOR 90 WATT AMPLIFIER.

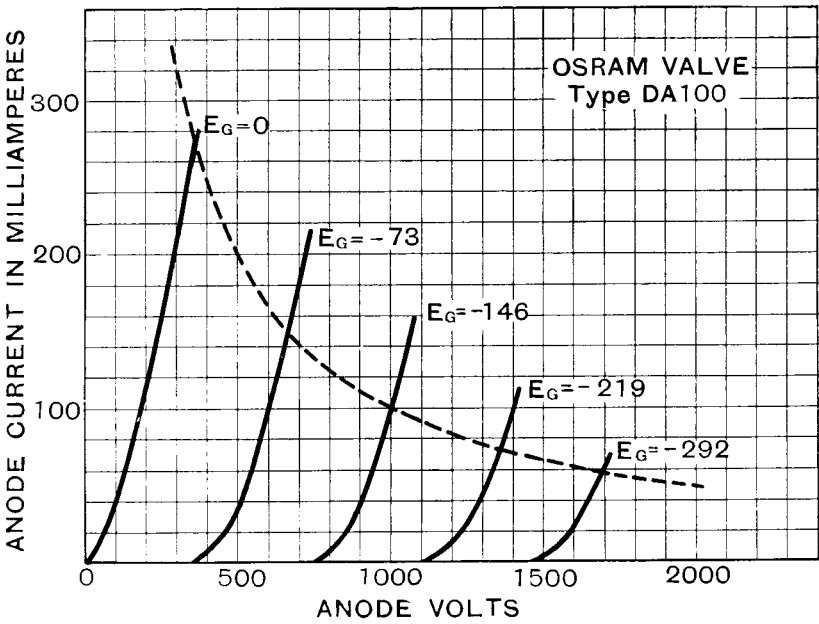

CHARACTERISTIC CURVES OF AVERAGE VALVE.

(Taken with D.C. Filament heating).



Made in England

THE UNIVERSAL RANGE FOR D.C.-A.C. RECEIVERS AND CAR RADIO

The following pages describe a range of valves suitable for operation with the heaters in series or parallel.

In D.C.-A.C. Universal Receivers the heaters are normally wired in series with a common current consumption of 0.3 ampere, thus proving economical in operation and at the same time having the features of common electrical characteristic with similar types in the A.C. mains range.

A complete range of types is available to meet all modern circuit requirements.

With the heaters wired in parallel on a common voltage rating of 13.0, the valves are suitable for use in an A.C. mains operated, or in a car radio receiver having the heater power derived from a 12 volt car battery.

The types are Indirectly Heated and are as follows :

High amplification Triode	Type H30.
Variable Mu Screen Pentode	Type W31.
Variable Mu Heptode Frequency Changers..	Types X30, X32.
Triode-Hexode Frequency Changer	Type X31.
Double Diode	Type D41.
Double Diode Triode	Type DH30.
Medium Slope Output Pentode	Type N30/G.
High sensitivity Power Pentode	Type N31.

A suitable rectifier for the above range, when used in a D.C.-A.C. Receiver is type U30, which is described in the section—RECTIFIER VALVES, and a range of 0.3 amp. Barretters for current regulation is also available (see page 120).

Osram Valves

Made in England.



Maximum Dimensions :
Overall length (including pins)
 140 m/m.
Diameter of bulb
 45 m/m.

TYPE W31

UNIVERSAL RANGE VARIABLE MU SCREEN PENTODE

(With Indirectly Heated Cathode).

The OSRAM W31 is a Variable Mu Screen Pentode suitable for use in the High Frequency or Intermediate Frequency Amplifying portions of a receiver. Its filament rating of 0.3 amp. makes it suitable for operation in D.C. and Universal Receivers employing valves having filaments of a similar current rating in series. An important feature of the W31 is the low value of anode-grid interelectrode capacity.

CHARACTERISTICS.

Heater Current	0.3 amp.
Heater Volts	13.0
	Max.
Anode Volts	250
Screen Volts	100
Control Grid Volts	
Anode Current average	
Screen Current average	
Fixed Bias Resistance	
Mutual Conductance	

Recommended Operating Condition.	
180-200	
100	
-2	-20
8.0 ma.	—
5.0 ma.	—
150 ohms.	—
2.7 ma/volt	0.01 ma/volt.

Interelectrode Capacities :—

Grid-Anode (others earthed)	0.0026 micro-microfarad approx.
Anode—other electrodes	8.7
Grid—other electrodes	14.0

For prices see
pages 126-129.

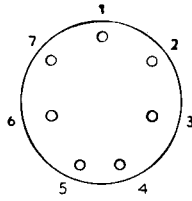

VIEW LOOKING ON
UNDERSIDE OF BASE

BASE, 7-PIN.

- 1: Metallising.
 - 2: Grid.
 - 3: Suppressor Grid.
 - 4: Heater.
 - 5: Heater.
 - 6: Cathode.
 - 7: Screen Grid.
- Top Cap : Anode.

Supplied in metallised bulb only.

TYPICAL OPERATING CONDITIONS.

It is recommended that a potentiometer network should be employed in order to maintain the screen voltage sensibly constant. This may conveniently be used also to supply the necessary screen voltage for a frequency changer such as type X31. Should a greater voltage output be required, as for example when used in the second stage of an I.F. amplifier, the screen voltage may be obtained by employing a dropping resistance in place of a potentiometer. This results in an increase in screen voltage and output, as the signal voltage and negative grid bias are increased.

TYPE W31

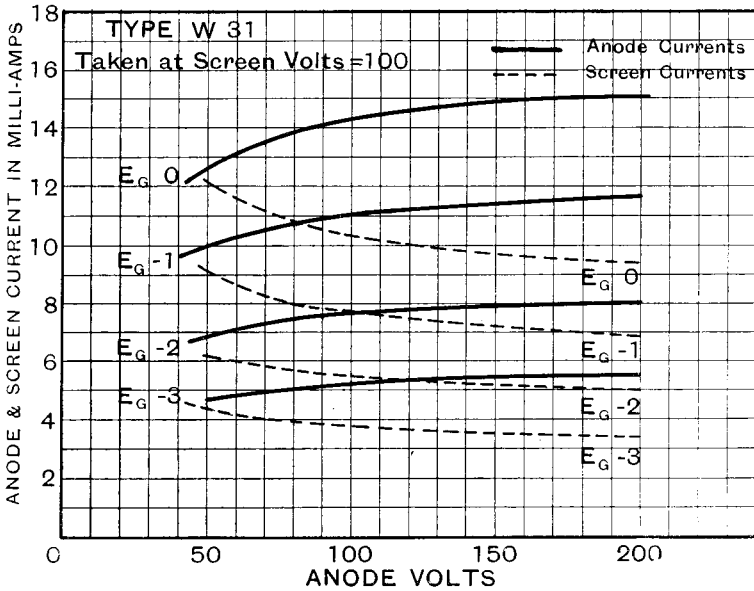
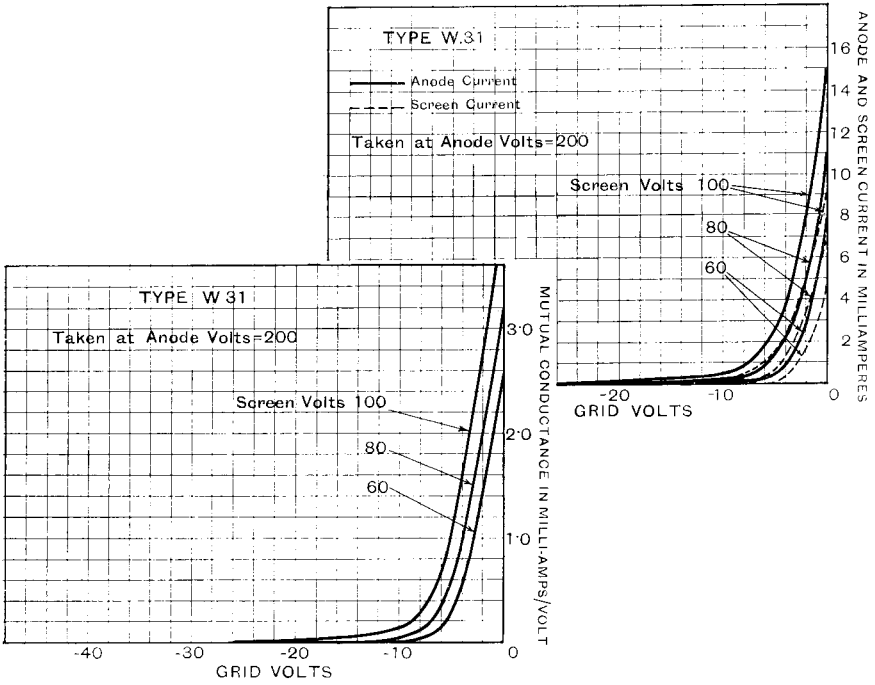

CHARACTERISTIC CURVES OF AVERAGE VALVE.

Osram Valves

Made in England.

TYPES X30 & X32

UNIVERSAL RANGE HEPTODE FREQUENCY CHANGERS

(With Indirectly Heated Cathode).



Maximum Dimensions :

Overall length (including pins)
135 m/m.

Diameter of bulb 45 m/m.

The OSRAM X30 and X32 are Heptode Valves for series or parallel running, such as in receivers intended for use with either D.C. or A.C. supply, or from 12-volt car batteries.

Their purpose is to operate as an electron coupled frequency changer in superheterodyne circuits. The Heptodes contain five grid electrodes, the function of these being as follows:—

G ₁ (in proximity to cathode)	Oscillator Grid.
G ₂	Oscillator Anode.
G ₃	Screen Grid.
G ₄	Detector Control Grid. (variable mu)
G ₅	Screen Grid (joined internally to G ₃)

Type X32 differs from Type X30 in its construction, which minimises modulation hum when used in D.C.—A.C. receivers designed for considerable low-frequency response.

CHARACTERISTICS.

Heater Current	0.3 amp.
Heater Volts	13.0
	Recommended Operating Conditions.
	180 to 250
Anode Volts	250
Screen Volts	100
Oscillator Anode Volts	150
Oscillator Grid Peak Swing	150
Control Grid Volts	10 volts
Anode Current average	-3 .. -30
Screen Current average	negligible
Oscillator Anode Current average	4.0 ma .. 3.5 ma
Total Cathode Current	2.1 ma .. 4.8 ma
Conversion Conductance	3.0 ma .. 8.3 ma
	9.1 ma .. 8.3 ma
	750 micromhos .. 2 micromho-

Interelectrode Capacities—

Anode—Control Grid G ₄	0.36	micro-microfarad approx.
Control Grid G ₄ —other electrodes	15.6	" .. "
Control Grid G ₄ —Oscillator Grid G ₁	0.23	" .. "
Control Grid G ₄ —Oscillator Anode G ₂	0.2	" .. "
Oscillator Grid G ₁ —other electrodes	12.2	" .. "
Oscillator Anode G ₂ —other electrodes	9.5	" .. "
Oscillator Anode G ₂ —Oscillator Grid G ₁	2.66	" .. "

(Taken on metallised valve)

For prices see
pages 126-129.

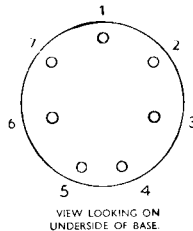

BASE, 7-PIN.

- 1: Oscillator Anode G₂
- 2: Oscillator Grid G₁
- 3: Screen Grids G₃, G₅
- 4: Heater
- 5: Heater
- 6: Cathode
- 7: Anode

Top Cap: Control Grid G₄

Types X30 and X32 are supplied with metallised bulb only.

TYPES X30 & X32

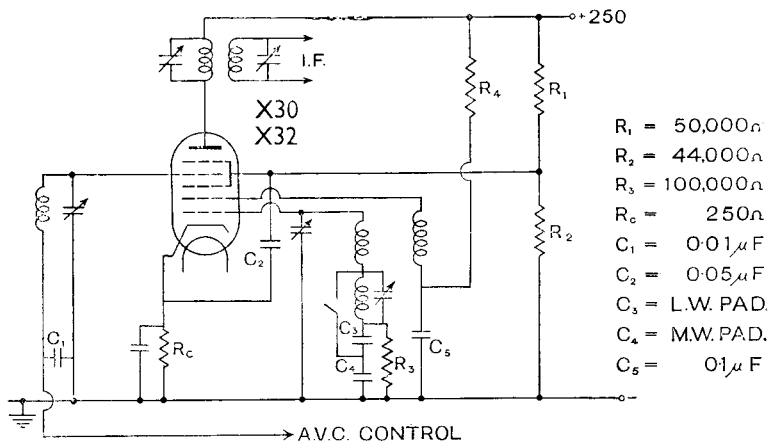

TYPICAL CIRCUIT DIAGRAM.

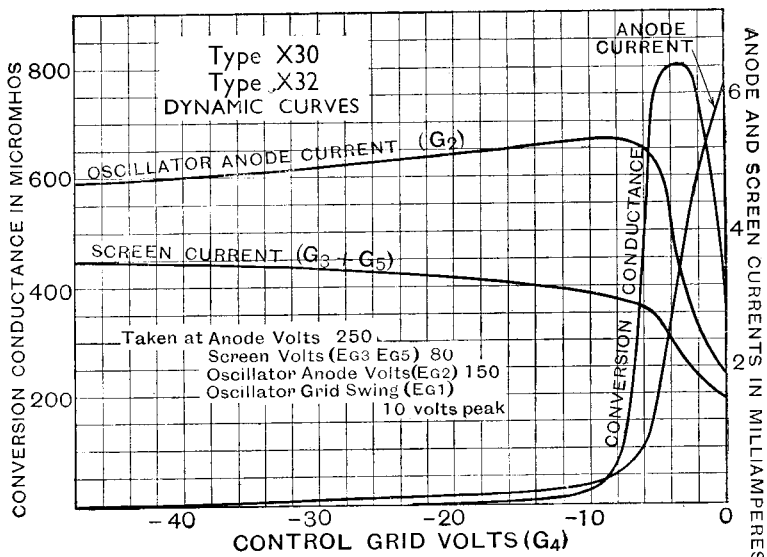

CHARACTERISTIC CURVES OF AVERAGE VALVES.

Osram Valves

Made in England.



TYPE X31 UNIVERSAL RANGE TRIODE-HEXODE FREQUENCY CHANGER. With Indirectly Heated Cathode.

The OSRAM X31 is a multi-electrode valve designed to perform as a mixer, first detector, or frequency changer valve in a superheterodyne receiver. Its filament rating of 13 volts 0.3 amp. makes it suitable for series running in D.C. and Universal Receivers. The valve consists of a cathode common to two sets of electrodes: (1) The Hexode, (2) The Triode.

The triode grid is connected to the mixer grid internally so that oscillations generated by the triode modulate the cathode hexode stream. The control grid of the hexode portion may be connected to an A.V.C. line as it has "variable mu" characteristics.

Type X31 is suitable for short wave receivers.

Maximum Dimensions :
Overall length (including pins)
135 m/m.
Diameter of bulb
45 m/m.

CHARACTERISTICS.

Heater Current	0.3 amp.
Heater Volts	13.0
		Recommended
	Max.	Operating
		Conditions.
Anode Volts 250	180—200
Screen Volts 80	70
Oscillator Anode Volts 150	100
Oscillator Grid Peak Swing 12v. peak	10-12v. peak
Control Grid Voltage	-1.5
Conversion Conductance average	640 micromhos
Conversion Impedance	0.75 megohms
Total Cathode Current average	7.6 ma.

Interelectrode Capacities :—

Control Grid—Anode	0.046 micro-microfarad approx.
Anode—Earth	21.5 " " "
Control Grid—Earth	7.0 " " "
Oscillator Grid—Oscillator Anode	3.56 " " "
Oscillator Anode—Earth	8.5 " " "
Oscillator Grid—Earth	17.0 " " "
Oscillator Grid—Control Grid	0.26 " " "

(Taken on metallised valve).

For prices see
pages 126-129.

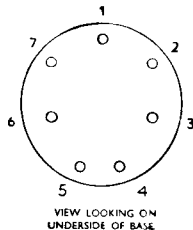

VIEW LOOKING ON
UNDERSIDE OF BASE

BASE 7-PIN.

- 1 : Oscillator Anode (A_o)
 - 2 : Oscillator & Mixer Grids (G₁, G₂)
 - 3 : Screen, (G₂, G₁)
 - 4 : Heater
 - 5 : Heater
 - 6 : Cathode
 - 7 : Anode (A)
- Top Cap : Control Grid, (G₁)

Type X31 is supplied in metallised bulb only.

TYPE X31

TYPICAL OPERATING CONDITIONS.

A typical circuit is shown herewith. The Screen grid should be fed from a low resistance potentiometer and care should be taken to reduce to a minimum any coupling between the oscillator and signal frequency circuits. In A.C.-D.C. receivers with the valve heaters connected in series the X31 should be so connected that A.C. voltage between heater and cathode is as low as possible. Care should be taken that the total resistance in the control grid to cathode circuit (A.V.C. decoupling resistances, etc.) does not exceed 2 megohms effective value.

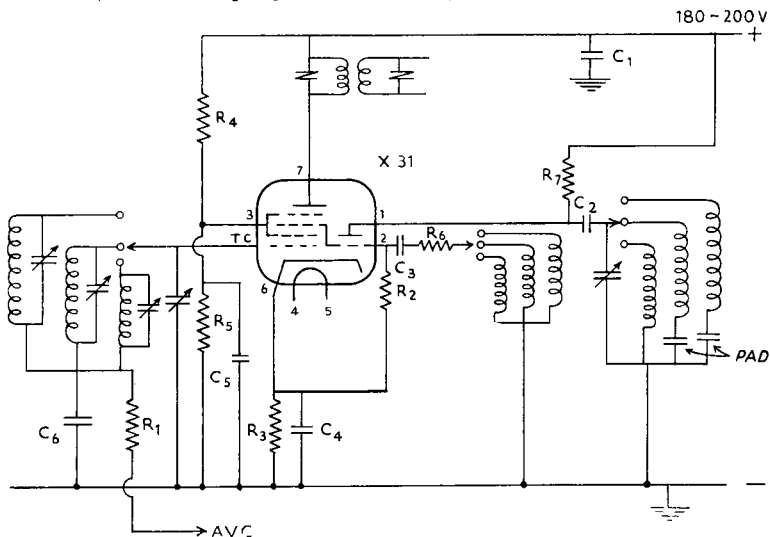

- R₁ 0.5 megohm
- R₂ 50,000 ohms.
- R₃ 200 ohms.
- R₄ 20,000 ohms.

- R₅ 20,000 ohms.
- R₆ 50-5000 ohms.
- R₇ 40,000-70,000 ohms.

- C₁ 0.1 mfd.
- C₂ 0.1 mfd.
- C₃ 0.0001 mfd.

- C₄ 0.1 mfd.
- C₅ 0.1 mfd.
- C₆ 0.05 mfd.

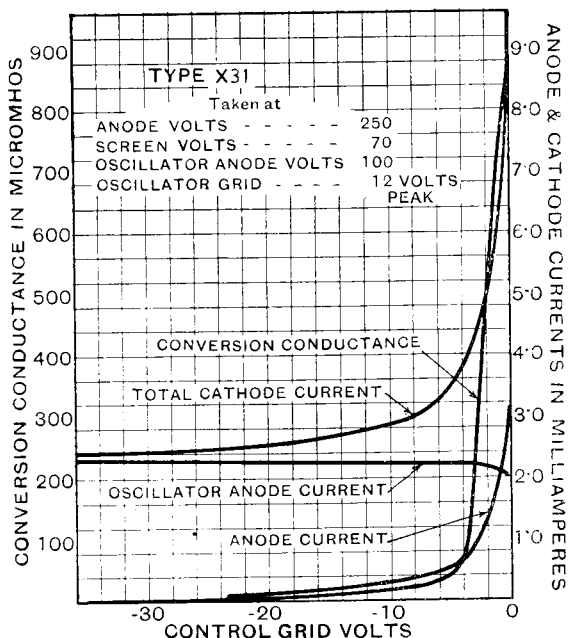

CHARACTERISTIC CURVES OF AVERAGE VALVE.



Osram Valves

Made in England

TYPE DH30

UNIVERSAL RANGE DOUBLE DIODE-TRIODE (With Indirectly Heated Cathode).

The OSRAM DH30 is an Indirectly Heated Cathode Valve combining double diode and triode electrode systems on a common cathode within the same envelope, and intended for series or parallel running such as in receivers for use on either A.C. or D.C. supply or from 12-volt car batteries.

Maximum Dimensions :
Overall length (including pins)
125 m/m.

Diameter of bulb 45 m/m.

CHARACTERISTICS.

Heater Current 0.3 amp.
Heater Volts 13.0

TRIODE CHARACTERISTICS.

Anode Volts 200 max.
Grid Volts -2
Anode Current average 2.8 ma
Amplification Factor 80
Impedance 18,000 ohms
Mutual Conductance 4.5 ma/volt measured
at anode volts 100,
grid volts 0.

DIODE CHARACTERISTICS.

With 0.5 megohm diode load resistance.

A.C. Volts R.M.S.	D.C. Volts across Diode Load
5	7
10	14
15	21
20	28
25	34

Interelectrode Capacities :—

Triode Grid-Anode 2.86 micro-microfarad approx
Triode Grid-Cathode 4.76 " " "
Triode Anode-Cathode 2.44 " " "
Each Diode Anode-Triode Grid 0.03 " " "
Diodes—all other electrodes 12.73 " " "
(Taken on metallised valve)

For prices see
pages 126-129.

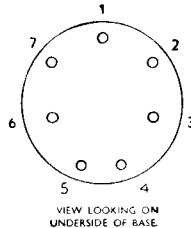

BASE, 7-PIN.

- 1: Diode
- 2: Metallising
- 3: Diode
- 4: Heater
- 5: Heater
- 6: Cathode
- 7: Anode

Metal Cap: Grid

VIEW LOOKING ON
UNDERSIDE OF BASE

Type DH30 has a carbonised bulb and can be supplied metallised if required.

TYPE D41 DOUBLE DIODE

With Indirectly Heated Cathode.

The OSRAM D41 is a Double Diode Valve for use as a combined Detector and Automatic Volume Control Valve in radio receivers. Its filament rating makes it suitable for series filament running so that it can be used with the 0.3 ampere range of D.C.—A.C. valves.

For full characteristics, dimensions, and base connections see pages 40-41. For prices see pages 126-129

Osram Valves

Made in England

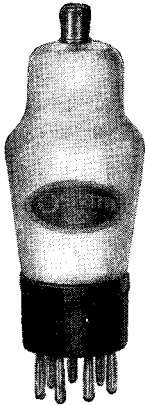

Illustrating Type H30.

Maximum Dimensions :

Overall length (including pins)
125 m/m.

Diameter of bulb 45 m/m.

TYPE H30 TYPE L30

UNIVERSAL RANGE TRIODES

(With Indirectly Heated Cathodes)

The OSRAM H30 and L30 are Triodes for series or parallel running, such as in receivers intended for use on either D.C. or A.C. supply, or from 12 volt car batteries.

Particular features of type H30 are : very low micro-
phonic response and, due to its design, very low residual
hum when used with the heater in series with other valves
in a receiver operated from A.C. mains supply. The valve
has a high Amplification Factor giving considerable gain
per stage.

Type L30 is a low impedance Triode suitable for use
in an L.F. amplifier.

CHARACTERISTICS.

Heater Current	0.3 amp.
Heater Volts	13.0

	H30			L30		
	Max.			Max.		
Anode Volts	250	200	150	200	150	100
Grid Volts	-1.7	-1.3	-1.0	-8	-7	-5
Anode Current (average)	5-5	5.5	3.8 ma.	25	16	9.6 ma.
Amplification Factor	80 } measured at anode			12 } measured at anode		
Impedance (ohms)	13,300 } volts 100, grid			2,860 } volts 100, grid		
Mutual Conductance ma./v.	6.0 } volts 0.			4.2 } volts 0.		
Automatic Bias Resistance	300 ohms			500 ohms		
Optimum Load Resistance	20,000 ohms.			6,000 ohms		

Type H30 Interelectrode Capacities:—

Grid-Anode (others earthed)	3.5 micro-microfarad approx.
Grid-other electrodes	5.0 " " "
Anode-other electrodes	2.7 " " "

For prices see
pages 126-129.

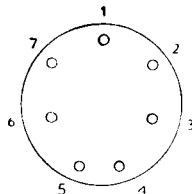

View looking on
Underside of base.

BASE :	BASE :
H30, 7-pin	L30, 7-pin
1: Metallising	1: —
2: —	2: Grid
3: —	3: —
4: Heater	4: Heater
5: Heater	5: Heater
6: Cathode	6: Cathode
7: Anode	7: Anode

Top cap: Grid

Type H30 has a carbonised bulb and can be supplied metallised if required.

Type L30 is supplied in clear bulb only.

TYPE H30

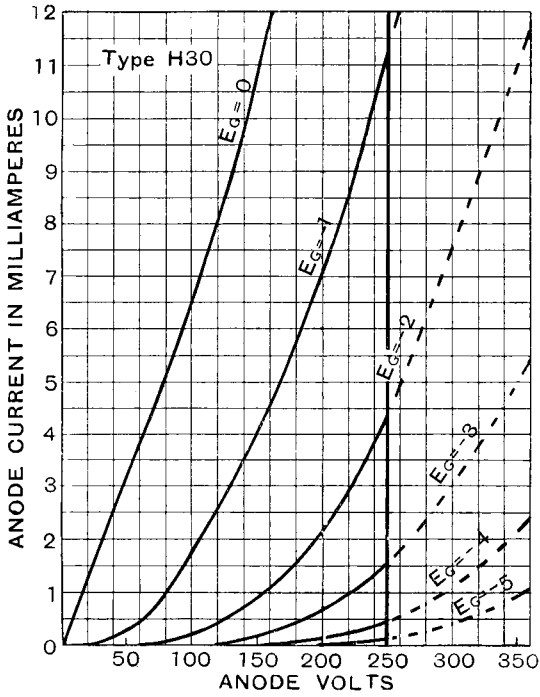

TYPE L30

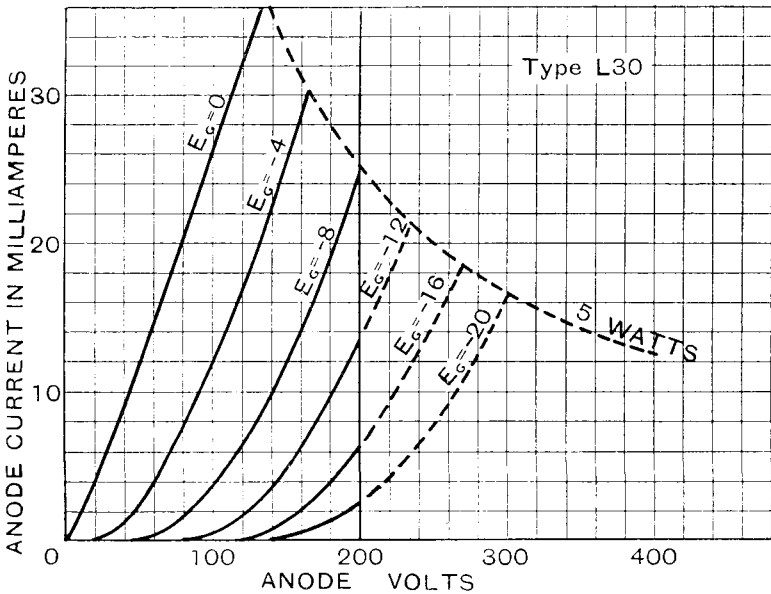

CHARACTERISTIC CURVES OF AVERAGE VALVES.



Maximum Dimensions :
 Overall length (including pins)
 130 m/m.
 Diameter of bulb
 51 m/m.

Osram Valves

Made in England.

TYPE N30/G UNIVERSAL RANGE OUTPUT PENTODE (With Indirectly Heated Cathode).

The N30/G is a Power Amplifying Pentode for series or parallel running, such as in receivers intended for use on either A.C. or D.C. supply, or from 12-volt car batteries.

The heater is intended :—

- (1) For series running with other valves in the receiver so that use can be made of the full supply voltage through a suitable limiting resistance.
- or (2) For parallel running with other valves in this range in car radio or A.C. mains sets.

CHARACTERISTICS.

Heater Current	0.3 amp.	
Heater Volts	13.0	
	Max.	
Anode Volts	250	180
Screen Volts	250	180
Grid Volts	-15	-8
Anode Current average	32 ma.	30 m.a.
Screen Current average	8 ma.	6 m.a.
Anode Dissipation	8 watts	5.4 watts
Mutual Conductance	3.9 ma/volt	
Automatic Bias Resistance	375 ohms.	220 ohms.
Optimum Load Resistance	7,500 ohms.	4,500 ohms.

For prices see
 pages 126-129.

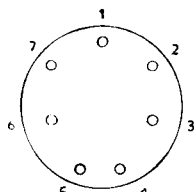

View looking on
 underside of base.

BASE, 7-PIN.

- 1: -
- 2: Grid
- 3: Screen Grid
- 4: Heater
- 5: Heater
- 6: Cathode
- 7: Anode

Type N30/G has a carbonised bulb.

TYPICAL OPERATING CONDITIONS.

Type N30/G is so designed that, while greatest undistorted output is obtained at the maximum anode and screen voltages of 250, adequate power is available at operating voltages of the order of 160—180 volts, as would normally be the case when used in a D.C.—A.C. receiver.

A grid stopping resistance is recommended, and the total grid resistance should not exceed 500,000 ohms.

TYPE N30/G

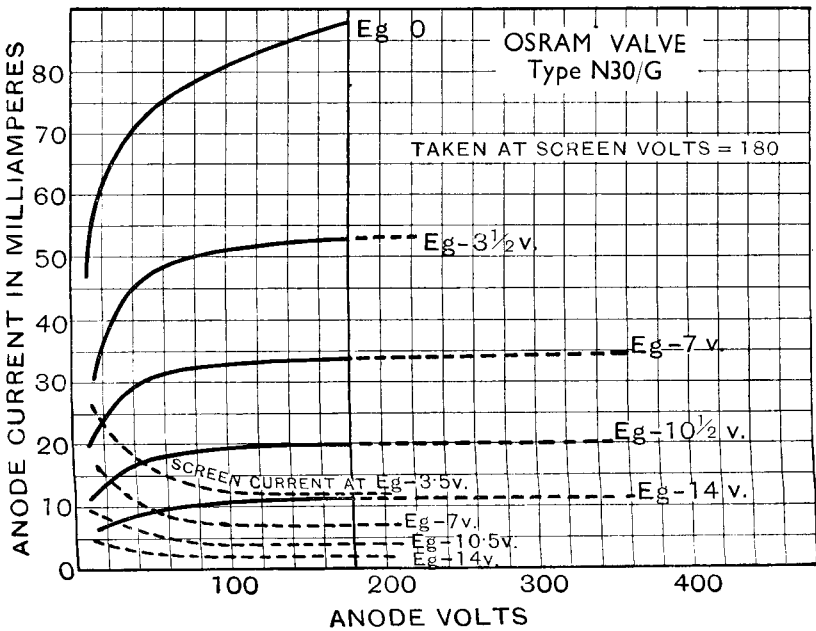
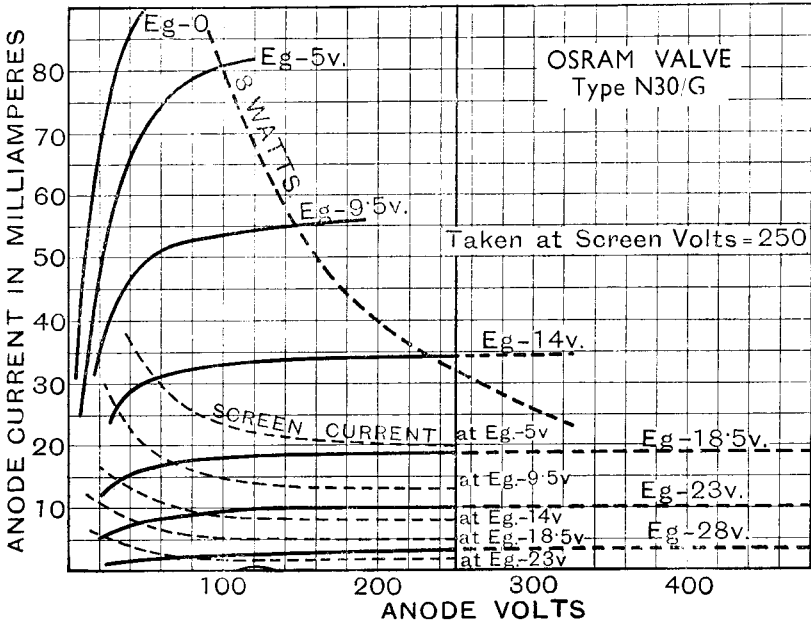

CHARACTERISTIC CURVES OF AVERAGE VALVE.

Osram Valves

Made in England.



Maximum Dimensions :
Overall length (including pins) 152 m/m.
Diameter of bulb 57 m/m.

TYPE N31

UNIVERSAL RANGE OUTPUT PENTODE

With Indirectly Heated Cathode.

The OSRAM N31 is a Power Amplifier Pentode for use in the output stage of radio receivers or low frequency amplifiers in which the heater is wired in series with the 0.3 amp. heaters of the remaining valves. It is thus suitable for use in D.C. or D.C.-A.C. Universal Receivers. The valve exhibits a high mutual conductance and as the result of its high sensitivity it can be fed directly from a diode detector. This enables the diode to operate with a much larger input voltage, giving a closer approach to distortionless amplification.

CHARACTERISTICS.

Heater Current	0.3 amp.	
Heater Volts	26.0	
	Max.	Recommended Operating Conditions.
Anode Volts	200	200
Screen Volts	180	180
Grid Volts	-4.4
Anode Current	40 ma.
Screen Current	10.6 ma.
Anode Dissipation	8 watts
Mutual Conductance	10.0 ma/volt.
Optimum Load Resistance	5,500 ohms.
Automatic Bias Resistance	87 ohms.
Interelectrode Capacities—		
Grid—Anode	0.7 micro-microfarad approx.	
Anode—other electrodes	11.0 " " "	
Grid—other electrodes	19.0 " " "	

For prices see pages 126-129.

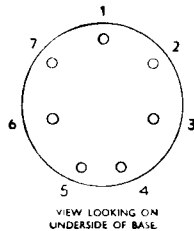

BASE, 7-PIN.

- 1: Heater Centre Tap.
 - 2: —
 - 3: Screen Grid
 - 4: Heater
 - 5: Heater
 - 6: Cathode
 - 7: Anode
- Top Cap: Control Grid

Type N31 has a carbonised bulb.

TYPICAL OPERATING CONDITIONS.

Owing to the high sensitivity of the N31 valve the wiring and arrangement of the circuit should be such as to keep the capacity between input and output circuits as low as possible. A grid stopper resistance of 100,000 ohms or anode stopper of 100 ohms should be included. It is recommended that the total resistance in the grid circuit should in no case exceed 500,000 ohms. Precautions should be taken to prevent H.F. or I.F. volts arriving at the grid of the valve. In a series heater circuit the N31 should be connected at the high potential end of the circuit, as shown opposite.

TYPE N31

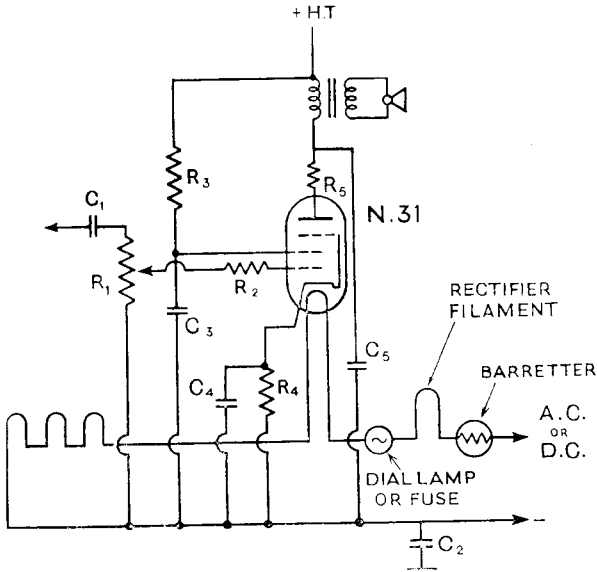

R_1	400,000 ohms variable	C_1	0.1 μ F
R_2	100,000 ohms	C_2	0.1 μ F.
R_3	4,000 ohms	C_3	2.0 μ F.
R_4	90 ohms	C_4	50 μ F. electrolytic
R_5	100 ohms	C_5	0.01 μ F.

TYPICAL CIRCUIT DIAGRAM FOR N31 VALVE IN OUTPUT STAGE OF D.C.-A.C. RECEIVER.

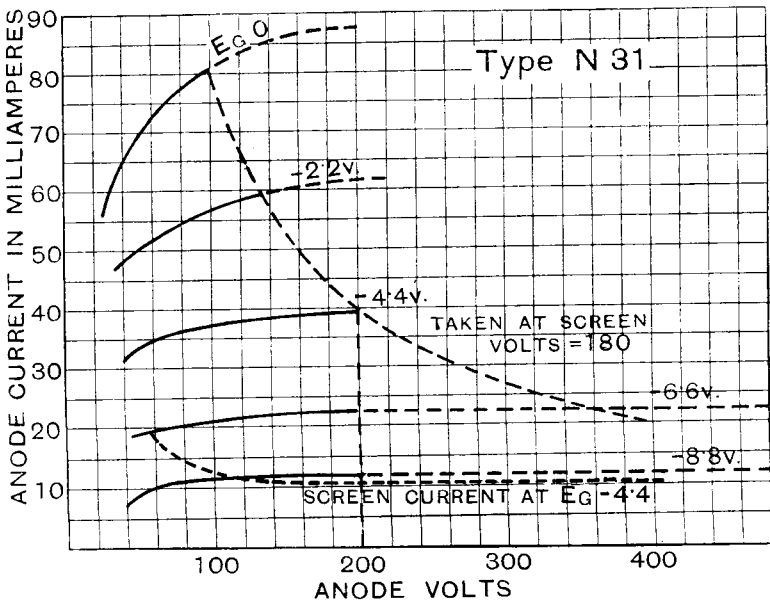

CHARACTERISTIC CURVES OF AVERAGE VALVE.

Osram Valves

Made in England

RECTIFYING VALVES

OSRAM Rectifying Valves for A.C. Mains Receivers have for years enjoyed a long period of consistent manufacture resulting in a product free from servicing troubles.

The importance of reliability in a Rectifier cannot be over-stressed as the failure of such a valve during service is liable to introduce troubles of a serious nature.

OSRAM Rectifying Valves are available covering a rectified output of from 60 mA up to 250 mA, including new types both in the hard vacuum thermionic class, and in the mercury vapour rectifier class. The types described include the following :

Full Wave Rectifier—

Directly Heated for 120 mA, 350v	Type U12.
Directly Heated for 120 mA, 500v	Type U14.
Indirectly Heated for 120 mA, 350v	Type MU12.
Indirectly Heated for 120 mA, 500v	Type MU14.
Directly Heated for 250 mA, 500v	Type U18.

Half Wave, Full Wave and Voltage doubling—

Indirectly Heated for Universal D.C.-A.C. sets, 120 mA, 250v, Type U30.

Half Wave Mercury Vapour Rectifier—

For 250 mA up to 1,000v	Type GU1.
For 250 mA, up to 1,500v	Type GU5.

Half Wave High Voltage Rectifiers, suitable for Cathode Ray Tube apparatus—

For 2 mA, 5,000v	Type U16.
For 30 mA, 2,500v,	Type U17.

Osram Valves

Made in England.



Maximum Dimensions :
Overall length (including pins)
140 m/m.
Diameter of bulb 57 m/m.

TYPE U12 TYPE U14

RECTIFYING VALVES

With Directly Heated Filament

(Full Wave).

The OSRAM U12 and U14 are rectifying Valves incorporating a dual electrode system in one bulb. Rectification of both half-cycles of the A.C. wave is obtained when the valve is fed from the A.C. Mains through a suitable transformer.

The valves are designed for a long life with ample and constant emission when operated at their rated voltage.

CHARACTERISTICS.

	U12		U14	
Filament Volts	4.0		4.0	
Filament Current	2.5 amps. approx.		2.5 amps. approx.	
	Max.		Max.	
Anode Volts R.M.S. (each anode)	350		500	
Rectified Current D.C.	120 m.a.	60 m.a.	120 m.a.	60 m.a.
(Smoothed with 4 mfd condenser)				
D.C. Output Volts	325	380	540	620
(For max-rated A.C. Volts input)				

For prices see
pages 126-129.

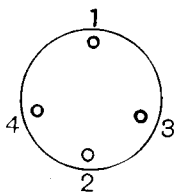

View looking on
underside of base

BASE, 4-PIN.

- 1: Anode
- 2: Anode
- 3: Filament
- 4: Filament

OPERATING CONDITIONS.

Variations in output voltage should never be made by dimming the filament, but may be made :

- (1) By tappings in the transformer secondary.
- (2) By the use of a resistance in series with the output.
- (3) By the use of a potentiometer, in which case the total current taken by the potentiometer and load should not exceed 120 m.a.

The D.C. output current should in no case exceed the maximum of 120 m.a. under smoothed conditions using a 4 mfd. input filter.

TYPE U12 TYPE U14

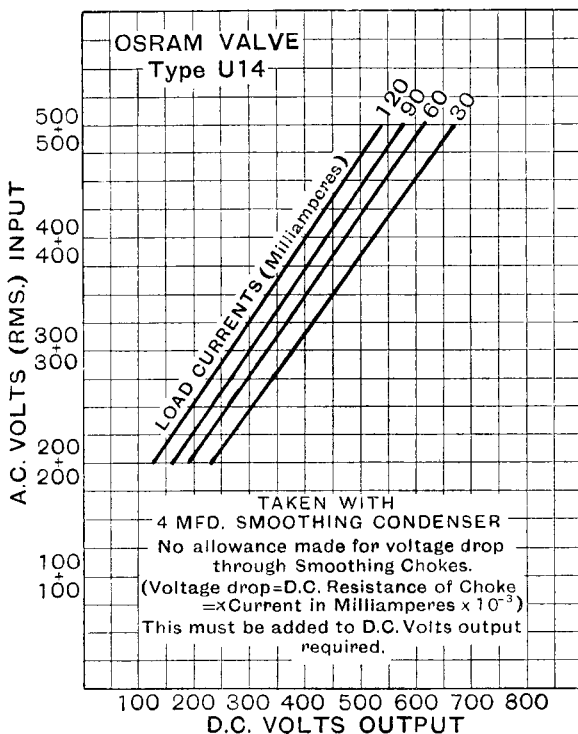
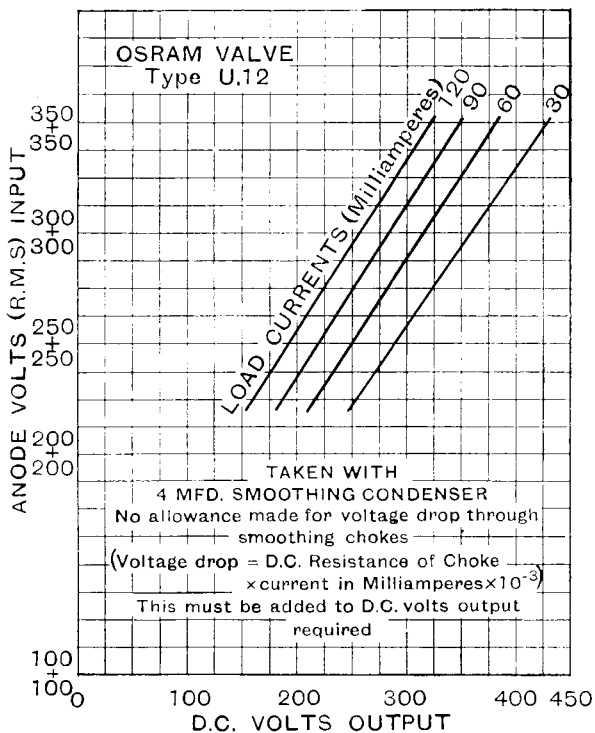

CHARACTERISTIC CURVES
OF AVERAGE VALVES.

Osram Valves

Made in England.



Maximum Dimensions :
Overall length (including pins)
130 m/m.

Diameter of bulb
51 m/m.

TYPE MU12 TYPE MU14 RECTIFYING VALVES.

With Indirectly Heated Cathode
(Full Wave)

The OSRAM MU12 and MU14 are full wave rectifier valves designed with an Indirectly Heated Cathode system. This enables the valves to attain a low effective impedance and their slow heating properties are of value in preventing high voltage surges when switching on in a receiver employing Indirectly Heated output valves.

Rectification of both half cycles of the A.C. wave is obtained when used with a suitable input transformer.

The valves are designed for long life and constant emission when operated at their rated voltage and output.

CHARACTERISTICS.

	MU12		MU14	
Heater Volts	4.0		4.0	
Heater Current	2.5 amps. approx. Max.		2.5 amps. approx. Max.	
Anode Volts R.M.S. (each anode)	350		500	
Rectified Current D.C. (smoothed with 4 mfd. condenser)	120 m.a.	60 m.a.	120 m.a.	60 m.a.
D.C. Output Volts (for max. rated A.C. volts input)	340	410	540	620

For prices see
pages 126-129.

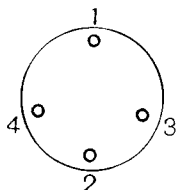

View looking on
underside of base.

BASE, 4-PIN.

- 1: Anode
 - 2: Anode
 - 3: Heater
 - 4: Heater
- } Cathode

OPERATING CONDITIONS.

Variations in output voltage should never be made by dimming the filament, but may be made :

- (1) By tappings in the transformer secondary.
- (2) By the use of a high resistance in series with the output.
- (3) By the use of a potentiometer, in which case the total current taken by the potentiometer and load should not exceed 120 m.a.

The D.C. output current should in no case exceed the maximum of 120 m.a. under smoothed conditions using a 4 mfd. input filter.

TYPE MU12 TYPE MU14

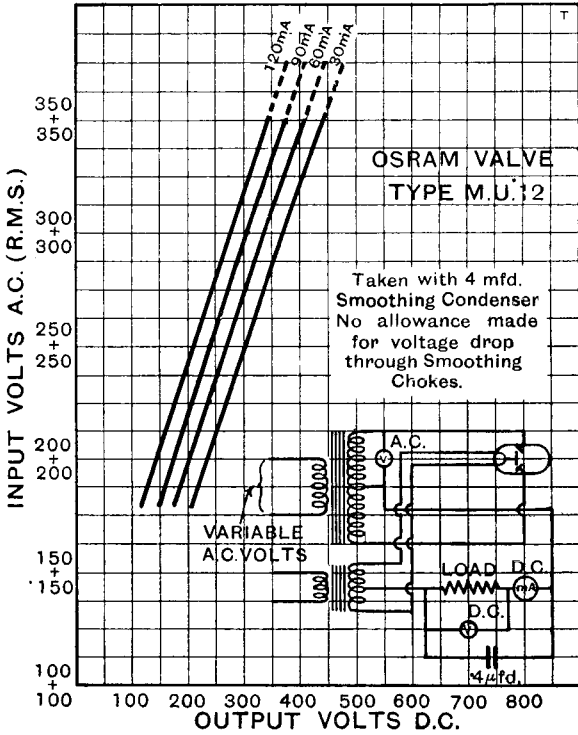

CHARACTERISTIC CURVES
OF AVERAGE VALVES.

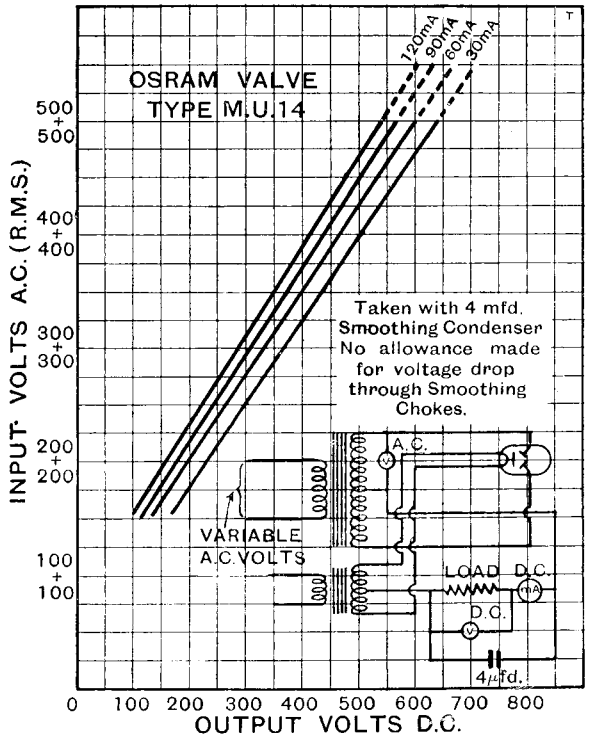

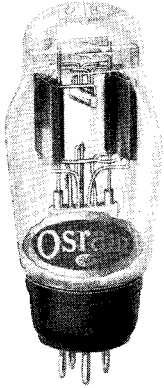

Osram Valves

Made in England.

TYPE U18 RECTIFYING VALVE

With Directly Heated Filament
(Full Wave).

The OSRAM U18 is a Rectifying Valve incorporating a dual electrode system in one bulb.

Rectification of both half cycles of the A.C. wave is obtained when the valve is fed from an A.C. supply through a suitable transformer.

The valve is designed for long life and constant emission when operated at its rated voltage and output.

Max. Dimensions :
Overall length (including pins)
140 m/m.

Diameter of bulb 56 m/m.

CHARACTERISTICS.

Filament Volts	4.0
Filament Current	3.75 amps approx.
Anode Volts R.M.S. (each anode)	Max.	500	
Rectified Current D.C. (smoothed with 4 mfd condenser)	250 mA.	150 mA.	
D.C. Output Volts (for 500 A.C. volts input)	520	580	

For prices see
pages 126-129.

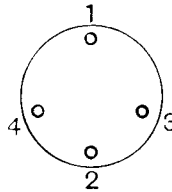

View looking on
underside of base

BASE, 4-pin.

- 1 : Anode.
- 2 : Anode.
- 3 : Filament.
- 4 : Filament.

OPERATING CONDITIONS.

Variations in output voltage should never be made by dimming the filament, but may be made :

1. By tappings in the transformer secondary.
2. By the use of a resistance in series with the output.
3. By the use of a potentiometer, in which case the total current taken by the potentiometer and load should not exceed 250 mA.

The D.C. output current should in no case exceed the maximum of 250 mA under smoothed conditions using a 4 mfd. input filter.

TYPE U18

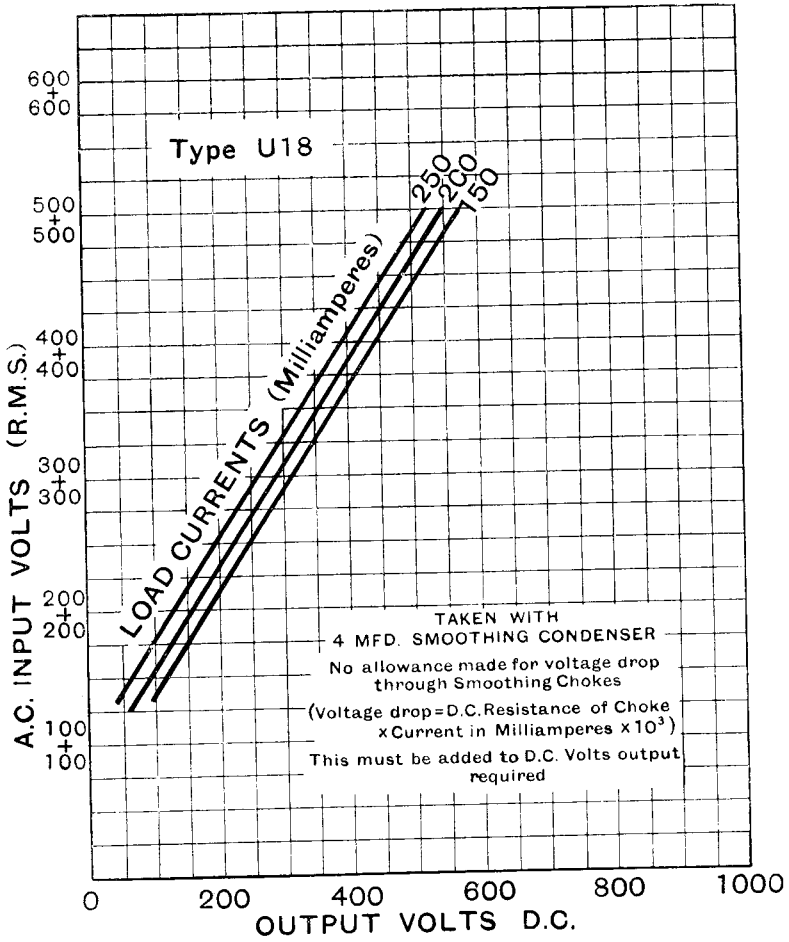

CHARACTERISTIC CURVES OF AVERAGE VALVE.

Osram Valves

Made in England.

TYPE U30 UNIVERSAL RANGE RECTIFIER (With Indirectly Heated Cathode).



Maximum Dimensions :
Overall length (including pins)
145 m/m.
Maximum diameter of bulb
57 m/m.

The OSRAM U30 is an Indirectly Heated Rectifier fitted with a 0.3 amp. 26 volt heater, thus making it suitable for wiring in series with other 0.3 ampere valves in a Universal A.C.-D.C. receiver. The valve may be used under the following conditions :

- 1—As a half wave rectifier with cathodes in parallel and anodes in parallel.
- 2—As a voltage doubling rectifier.
- 3—As a full wave rectifier.

As a half wave rectifier for D.C.-A.C. Receivers.
The two anodes should be connected by strapping pins 2 and 7 on the base. In the case of an A.C. mains supply the valve then functions as a half wave rectifier, the cathode being at the positive voltage of the rectified feed. When used on a D.C. supply the U30 merely functions as a resistance in H.T. feed.

CHARACTERISTICS

Heater Current	{ 0.3 amp.	or	{ 0.6 amp.
Heater Volts	{ 26		{ 13
Anode Volts R.M.S. (each anode) 250 max.

As Half-Wave Rectifier (Anodes in parallel).

Rectified Current D.C... .. . 120 m.a. max.
(Smoothed with 8-32 mfd. condenser)

As Voltage Doubler.

Rectified Current D.C... .. . 75 m.a.
(Smoothing condensers 8 mfd. each in series)

As Full-Wave Rectifier.

Rectified Current D.C... .. . 120 m.a.
(Smoothed with 4 mfd. condenser).

For prices see
pages 126-129.

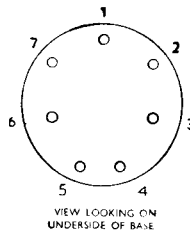

BASE, 7-PIN.

- 1: Heater Centre Tap
- 2: Anode₁
- 3: Cathode₁
- 4: Heater
- 5: Heater
- 6: Cathode₂
- 7: Anode₂

OPERATING CONDITIONS.

As Half-Wave Rectifier (Anodes in parallel).

Anode Volts (A.C. Input R.M.S.)	Rectified Current m.a.	*Output Volts	Drop Across Rectifier. Volts. (For D.C. condition)
250	120	250	—
200	120	172	20
	60	212	13

* With 16 mfd. condenser and neglecting voltage drop across smoothing chokes.

TYPE U30

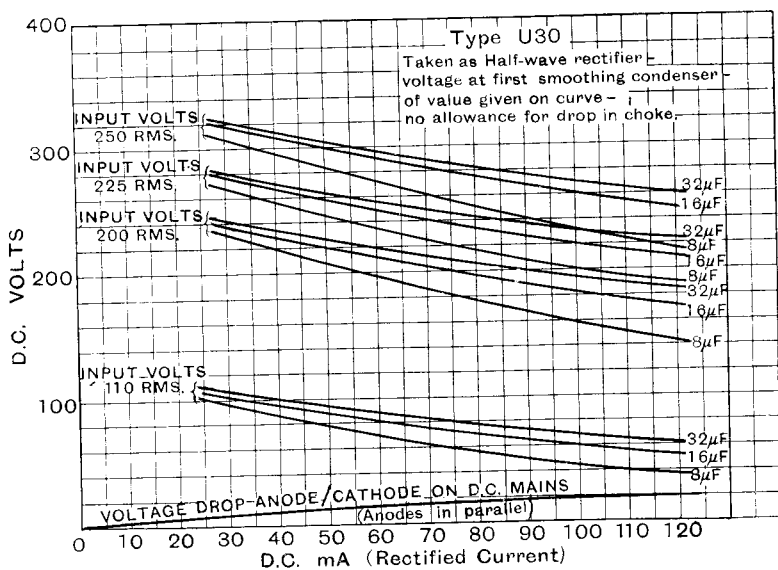
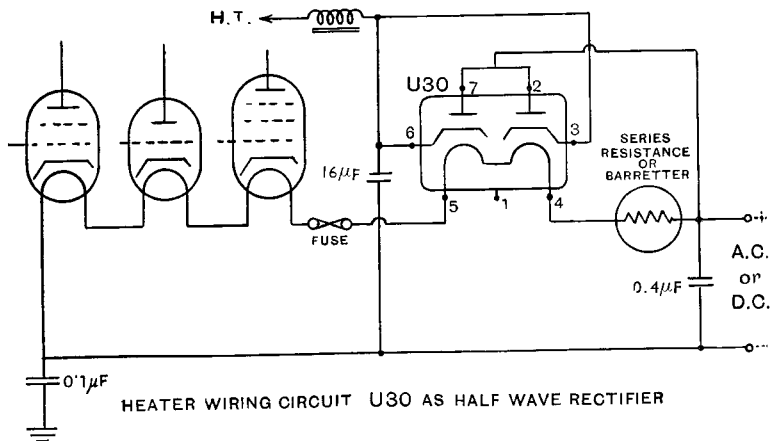

CHARACTERISTIC CURVES OF AVERAGE VALVE.

Osram Valves

Made in England



Approx. Dimensions :
Overall length (including pins)
130 m/m.
Maximum diameter of bulb
50 m/m.

TYPE U16 RECTIFYING VALVE With Directly Heated Filament (Half Wave).

The OSRAM U16 is a Half Wave Rectifier Valve designed primarily to supply the accelerator, or anode voltage to Cathode Ray Tubes. For this purpose it is capable of withstanding an anode voltage up to 5,000 volts R.M.S. and the rectified current output is adequate.

The type is not intended for power rectification purposes where rectified currents greater than 2 milliamps are required.

CHARACTERISTICS.

Filament Volts	2.0
Filament Current	0.25 amp. approx.
Anode Volts R.M.S.	5,000 max.
Rectified Current D.C. (smoothed with 0.25 mfd. condenser) ..	2.0 ma. max.

For prices see
pages 126-129.

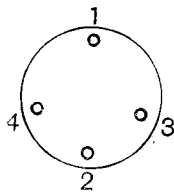

View looking on
underside of base.

BASE, 4-pin.

Pin 1: —
2: —
3: Filament
4: Filament
Top Cap: Anode

OPERATING CONDITIONS.

A typical circuit is shown overleaf in which it is recommended that resistance capacity smoothing is employed, a value of 100,000 ohms in conjunction with 0.25 mfd. condensers being adequate.

Care should be taken that the filament voltage is maintained at the rated value to ensure satisfactory life.

The data given are taken with a transformer of good regulation. A reduction of from 300 to 500 volts at 2 milliamps is likely to occur with small commercial transformers.

TYPE U16

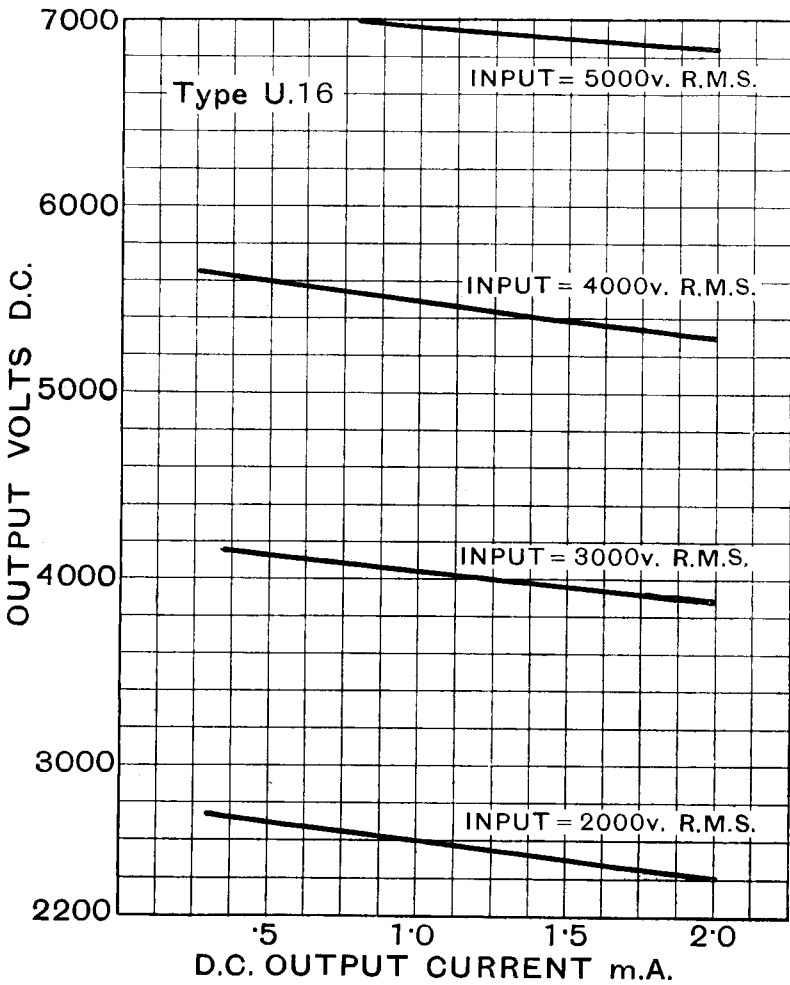
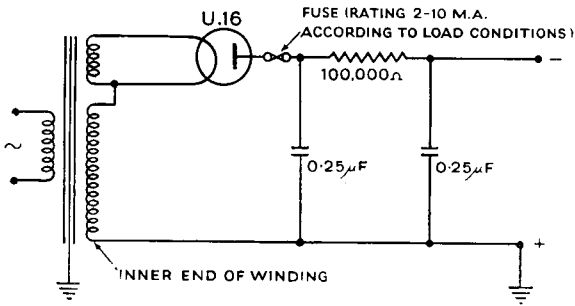

CHARACTERISTIC CURVES OF AVERAGE VALVE.

Osram Valves

Made in England

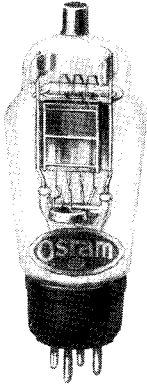

Maximum Dimensions :
Overall length (including pins)
 140 m/m.
Diameter of bulb
 51 m/m.

TYPE U17 RECTIFYING VALVE

With Directly Heated Filament
(Half Wave)

The OSRAM U17 is a high voltage Half Wave Rectifier capable of withstanding an anode voltage up to 2,500 volts R.M.S. and of giving an output of 30 mA. The type is suitable for supplying the voltages necessary for Cathode Ray Tube and associated circuits.

CHARACTERISTICS.

Filament Volts	4.0
Filament Current	1.0 amp. approx.
Anode Volts R.M.S.	2,500 max.
Rectified Current D.C. (smoothed with 1.0 mfd. condenser)	30 mA. max.

For prices see
pages 126-129.

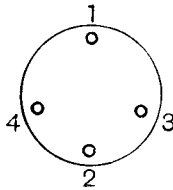

View looking on
underside of base

BASE, 4-pin.
 Pin 1: —
 2: —
 3: Filament
 4: Filament
 Top Cap: Anode

OPERATING CONDITIONS.

Care should be taken that the filament voltage is maintained at the rated value in order to secure a satisfactory life and under no circumstances must variation of the filament volts be used as a means of varying the output.

TYPE U17

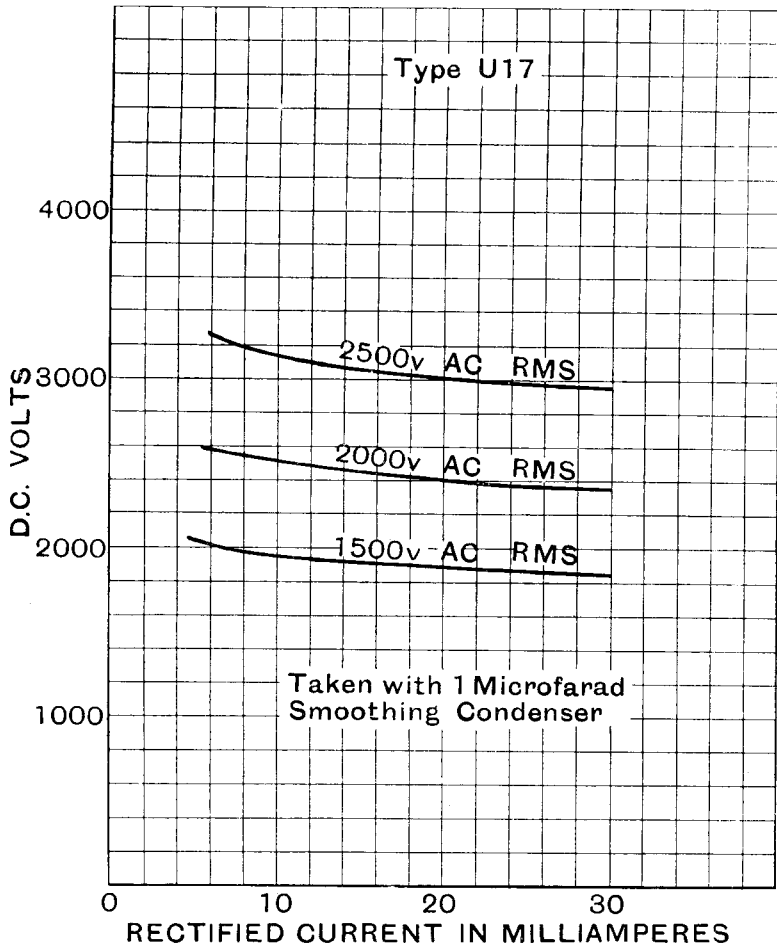

CHARACTERISTIC CURVES OF AVERAGE VALVE.

Osram Valves

Made in England.

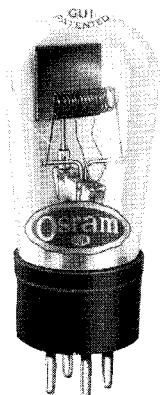

Illustrating Type GU1

Maximum Dimensions :
Overall length (including pins)
110 m/m.
Diameter of bulb 45 m/m.

TYPE GU1 TYPE GU5 HOT CATHODE MERCURY VAPOUR RECTIFYING VALVES (Half Wave).

The OSRAM GU1 and GU5 are half wave Mercury Vapour-filled Rectifiers suitable for the supply of rectified current up to 250 milliamps without the necessity for the application of high A.C. voltages. Under normal conditions the bulb is filled with a blue glow due to ionisation of the mercury vapour. By virtue of the gas-filling the impedance of the rectifier is low which ensures high efficiency of rectification and results in a practically constant voltage drop across the valve of 15 volts, while the discharge is maintained.

Two such rectifiers may be used in a bi-phase circuit to give full wave rectification if desired, whereby a total rectified current of up to 500 milliamps may be obtained.

Type GU1 is suitable for anode voltages up to 1,000 max.; type GU5 will withstand voltages up to 1,500 max.

CHARACTERISTICS.

	GU1	GU5
Filament Volts	4.0	4.0
Filament Current	3.0 amps. approx.	3.0 amps. approx.
Anode Volts (R.M.S.)	Up to 1,000	Up to 1,500
Max. Rectified Current (with Delayed Switching of Anode voltage)*	250 m.a.	250 m a.

* See operating conditions below.

For prices see
pages 126-129

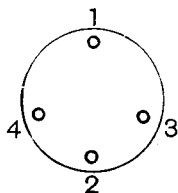

View looking on underside of base.

GU1
BASE, 4-pin.
Pin 1: Anode
2: --
3: Filament
4: Filament

GU5
BASE, 4-pin.
Pin 1: —
2: —
3: Filament
4: Filament
Top Cap: Anode

OPERATING CONDITIONS.

On no account must the H.T. voltage be applied to the valve at the same time as application of filament voltage. The filament should be switched on from half to one minute before the H.T. in every case. Similarly the H.T. should be switched off before or at the same time as the filament.

In order to ensure reliable life operation it is important that after transit, or following a period of disuse, the filament should be run at operating temperature for 15 minutes before the anode voltage is applied.

A positive voltage greater than 15 should never be applied to the anode without the addition of a series resistance to limit the current.

Variations in output current may be obtained by the use of a potentiometer or series resistance. On no account must the output be regulated by controlling the filament voltage.

When used under the maximum rectified current conditions a choke input to the filter circuit is recommended of values as shown opposite.

TYPE GU1

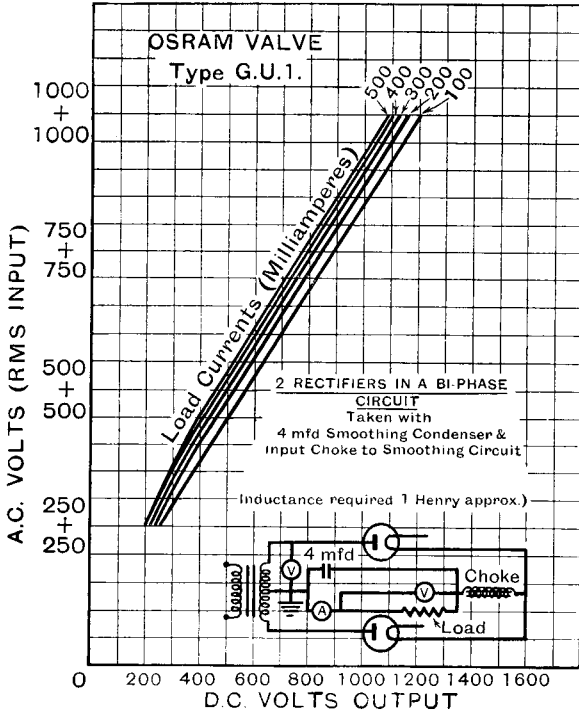

TYPE GU5

AVERAGE
CHARACTERISTIC CURVES.

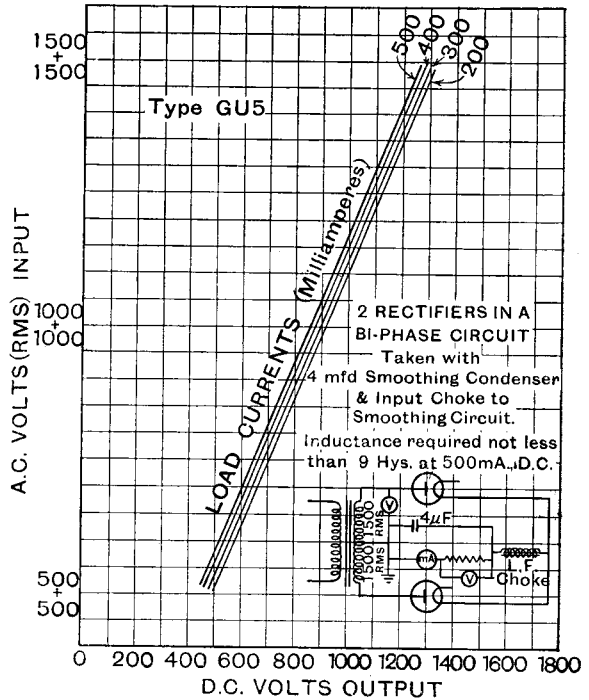



Made in England

SPECIALISED VALVE TYPES

In the following pages will be found technical data and characteristics of certain types of valves developed for specialised purposes, such as in microphone head amplifiers, and for industrial and laboratory applications.

Included in these types are the following :

A Single Diode suitable for use in television receiving apparatus . . . Type D42.

High sensitivity Output Pentode with features of low interelectrode capacity, suitable for use in television and high frequency power amplifiers. . . Type N43.

A special design low capacity Triode for ultra-high frequency circuits (the "Acorn") Type HA1.

Indirectly Heated Triode with feature of low microphonic design for condenser microphone amplifiers, etc. Type A537.

Indirectly Heated high gain Triode, for use in microphone amplifiers followed by high gain Type MH40.

Indirectly Heated Triode with high input resistance, for use in Valve Voltmeters. Type A577.

In addition to the thermionic valves, technical data are given for Gasfilled Relays for which applications are available in industrial apparatus and in time base circuits for Cathode Ray Oscillographs :

Mercury Vapour Gasfilled Relay for 1.0 amp. peak anode current (0.3 amp. average value) Type GT1.

Argon filled Gasfilled Relay for 0.6 amp. peak anode current (0.2 amp. average value) Type GT1A.

Data are also given covering Barretters suitable for the approximate regulation of currents of values 0.3 amp. and 0.2 amp. on various voltage ranges.

The "Tuneon Indicators" for visual tuning are described with circuit applications.

Osram Valves

Made in England.



Maximum Dimensions :
Overall length 86 m/m.
Diameter of bulb 29 m/m.

TYPE D42 SINGLE DIODE

With Indirectly Heated Cathode.

The OSRAM D42 is a Single Diode Valve with more generous emission than type D41.

It is suitable for use as a second Detector in super-heterodyne receivers, and also as a rectifier to provide A.V.C. voltage.

Type D42 is not suitable for use as a power rectifier.

CHARACTERISTICS.

Heater Volts	4.0
Heater Current	0.6 amp. approx.
Max. A.C. or H.F. volts	75 volts R.M.S.
Max. Rectified Current	15 m.a. D.C.

Interelectrode Capacities :

Diode to Cathode	4.0 m.mfd. approx
------------------	----	----	----	----	----	----	----	----	----	-------------------

For prices see
pages 126-129.

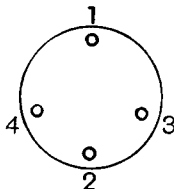

BASE, 4-pin.

- Pin 1: Anode
- 2: Cathode
- 3: Heater
- 4: Heater

TYPE D42

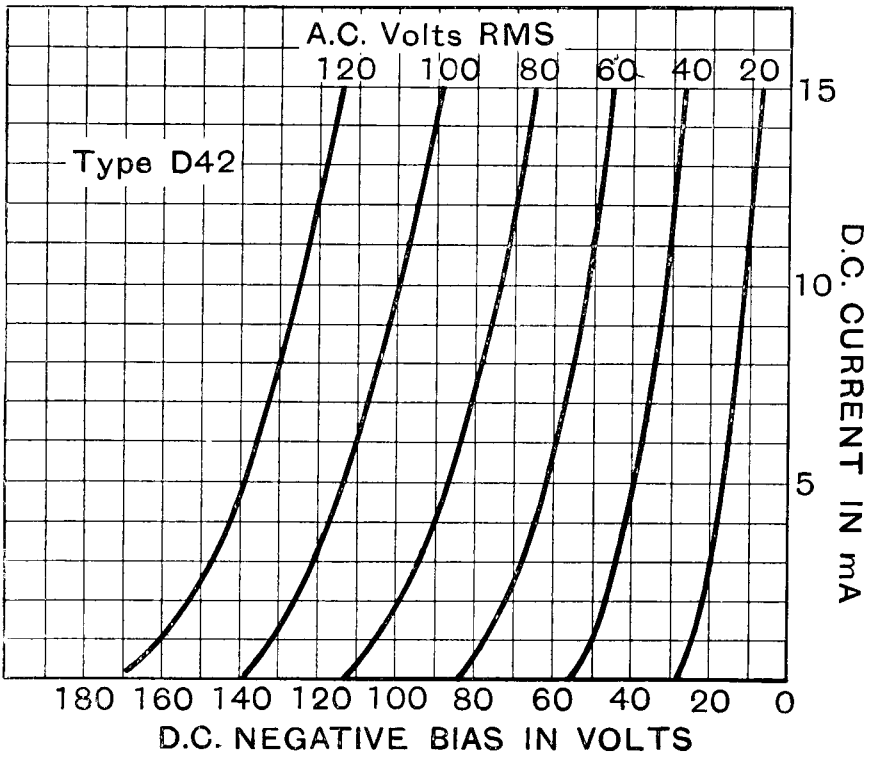

CHARACTERISTIC CURVES OF AVERAGE VALVE.

Osram Valves

Made in England



Maximum Dimensions :
Overall length (including pins)
 152 m/m.
Diameter of bulb 57 m/m.

TYPE N43 SCREENED OUTPUT PENTODE

With Indirectly Heated Cathode
 (For operation from A.C. Mains).

The OSRAM N43 is an Indirectly Heated Pentode designed to combine high sensitivity, large undistorted power output and a low value of interelectrode capacity. To achieve these results the type has a high value of mutual conductance and employs an electrode design with the grid taken to a top cap connection which results in a value of anode-grid capacity considerably lower than in the normal power amplifying pentode.

Type N43 is thus particularly applicable to high quality receivers or amplifiers, or to the output stage of the vision channel in Television Receivers which are required to deal with a very wide band of audio frequencies without attenuation.

CHARACTERISTICS.

Heater Volts	4.0	
Heater Current	2.0	amps. approx.
							Max.	
Anode Volts	250	250
Screen Volts	250	200
Grid Volts	-4.5	-3.5
Anode Current average	40 mA	32 mA
Screen Current average	10 mA	8 mA
Anode Dissipation	10 watts	8 watts
Mutual Conductance	10.0 mA/volt	10.0 mA/volt
Optimum Load Resistance	5,400	7,800 ohms.
Automatic Bias Resistance	90	90 ohms

Interelectrode Capacities :

Grid to Anode	0.3	m.mfd.
Anode to other Electrodes (Output)	16.5	"
Grid to other Electrodes (Input)	15.5	"

For prices see
 pages 126-129.

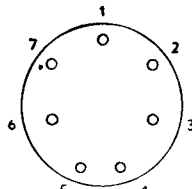

VIEW LOOKING ON
 UNDERSIDE OF BASE

BASE, 7-pin.

Pin 1: —
 2: —
 3: Screen
 4: Heater
 5: Heater
 6: Cathode
 7: Anode
 Top Cap: Grid

TYPICAL OPERATING CONDITIONS.

Owing to the high sensitivity a grid stopping resistance is recommended, but the total resistance in the grid circuit should in no case exceed 500,000 ohms.

Type N43 should only be employed with full automatic grid bias.

TYPE N43

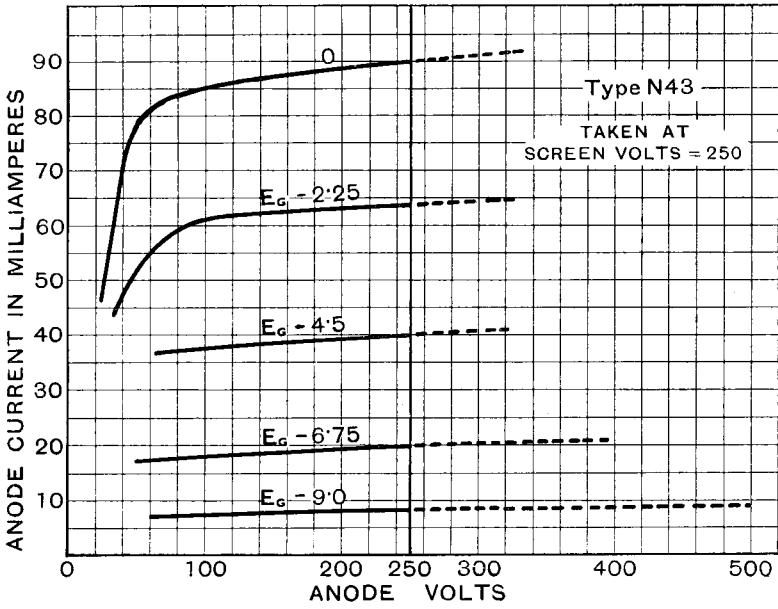

CHARACTERISTIC CURVES OF AVERAGE VALVE.

Osram Valves

Made in England.



Illustration full size.

Maximum Dimensions :
 Overall Height 35 m/m.
 Diameter of Bulb 13.5 m/m.
 Diameter of glass seal 22 m/m.

TYPE HA1 MINIATURE LOW CAPACITY TRIODE (With Indirectly Heated Cathode).

The OSRAM HA1 is an Indirectly Heated Triode of special design intended to reduce the capacity between the electrodes, or their respective support and lead-in wires, to a minimum. In order to achieve this result the electrode supports are taken to a circular seal mounting instead of to the normal base. Due to the low capacity between electrodes, type HA1 is particularly applicable to operation either for reception or low power transmission on ultra-short wavelengths of the cm. order, and may also be applied to ultra-high frequency amplification where, with suitable circuit and lay-out of components, a material gain per stage can be achieved.

CHARACTERISTICS.

Heater Volts	4.0
Heater Current	0.3 amp. approx. max.
Anode Volts	180
Grid Volts	-6.5
Anode Current	4.5 ma. max.
Amplification Factor	20
Impedance	11,800 ohms
Mutual Conductance	1.7 mA/v measured at $E_a = 100$, Ia 4 ma.

Interelectrode Capacities :

Grid to Anode	1.4 m.mfd. approx.
Anode to Cathode	0.6 " "
Grid to Cathode	1.0 " "

For prices see
 pages 126-129.

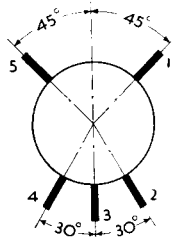

PIN ARRANGEMENT.

- 1: Anode
- 2: Heater
- 3: Cathode
- 4: Heater
- 5: Grid

Angular spacing and connections
 of ultra short wave valve.
 View from above, i.e. end containing
 electrode system.

In no circumstances should connections be soldered to valve contacts.

TYPE HA1

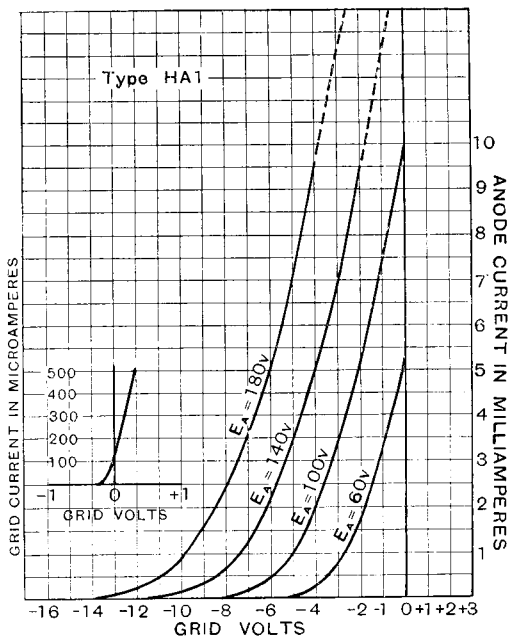
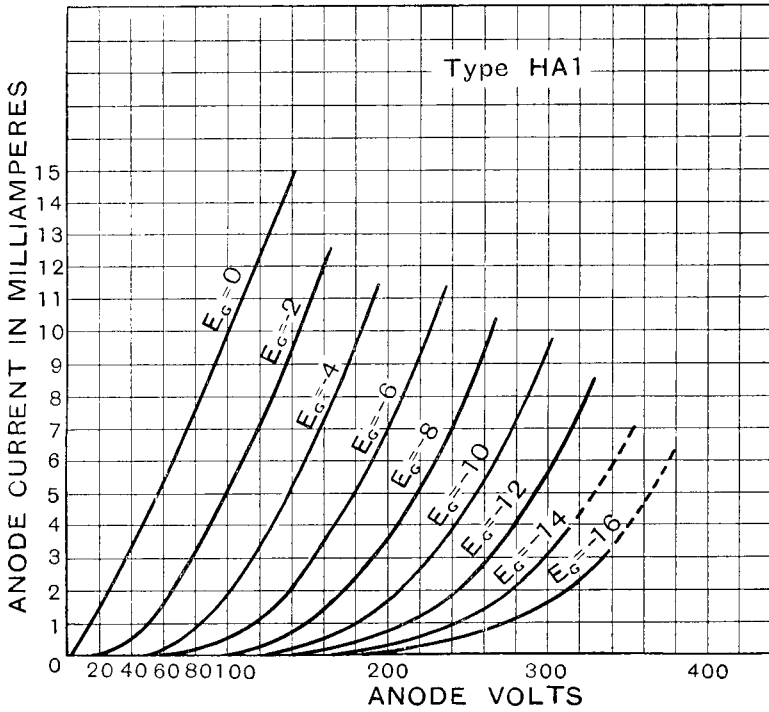

CHARACTERISTIC CURVES OF AVERAGE VALVE.

Osram Valves

Made in England.



Maximum Dimensions :
Overall length 77 m/m.
Diameter of bulb
29 m/m.

For prices see
pages 126-129.

TYPE A537 TRIODE FOR MICROPHONE AMPLIFIERS, With Indirectly Heated Cathode. (For operation from low tension battery).

The OSRAM A537 is a Triode suitable for use in the initial stages of microphone amplifiers. The particular feature of the A537 is its very low order of microphony and background noise, thus enabling a high gain amplifier to be employed in conjunction with microphones of the condenser type. The small physical dimensions of the valve afford ready portability and enable the valve to be built in as an integral part of the microphone equipment. The A537 is fitted with an Indirectly Heated Cathode.

CHARACTERISTICS.

Filament Volts	4.0 max.			
Filament Current	0.4 amp.			
Anode Volts	Max. 150	100	50	
Amplification Factor	15.5		
Impedance	10,000 ohms.		
Mutual Conductance	1.55 ma./v.		
							(measured at grid volts, 0)		
Grid Bias volts	-6	-3	-2.0	
Anode Current, average	3.3 ma.	3.0 ma.	1.0 ma.	
Interelectrode Capacities :-									
Anode-Grid	1.7	micro-microfarad approx.		
Grid-Filament	1.4
Anode-Filament	1.5

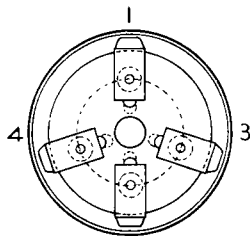

2
VIEW OF UNDERSIDE
OF BASE

BASE. Small 4 side-contact type.

Pin 1: Anode.
2: Cathode.
3: Filament.
4: Filament.
Top Cap: Grid.

OPERATING CONDITIONS.

Type A537 is intended for use on a D.C. (Battery) filament supply. If an attempt is made to employ A.C. filament heating, some hum may be experienced when used in a high gain amplifier.

TYPE A537

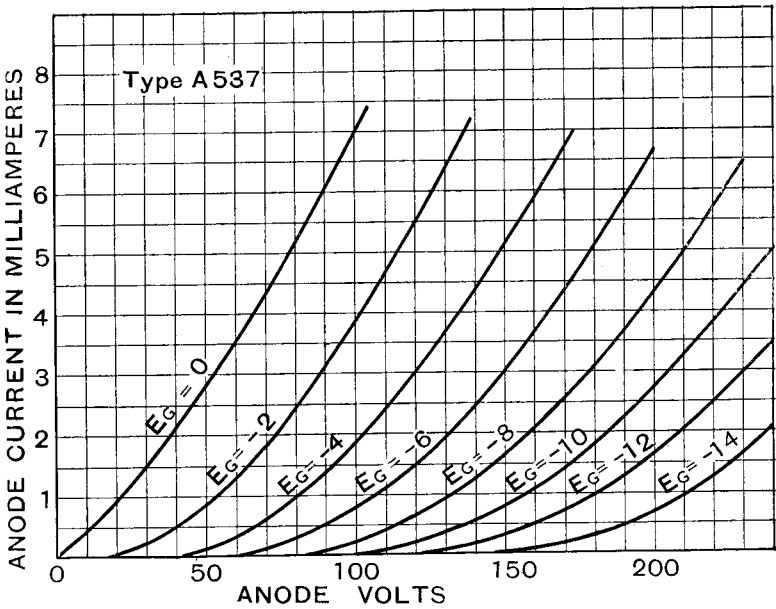
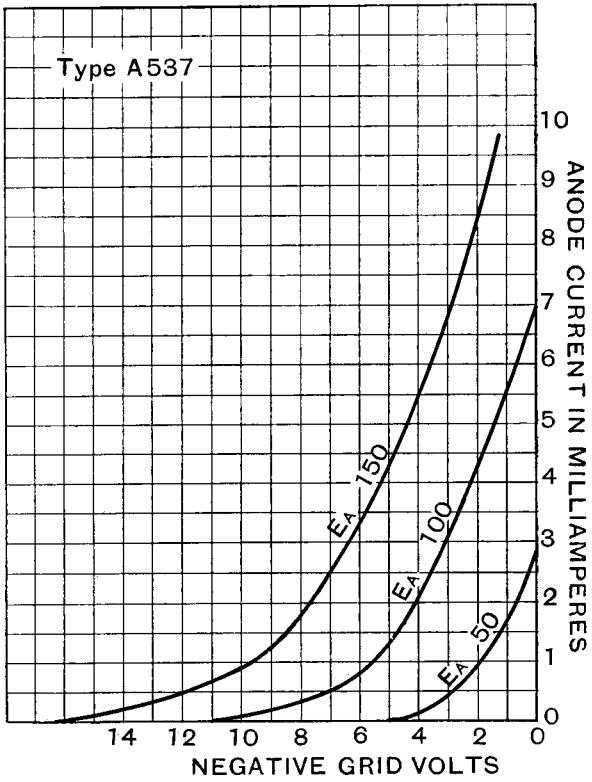

CHARACTERISTIC CURVES OF AVERAGE VALVE.

Osram Valves

Made in England.

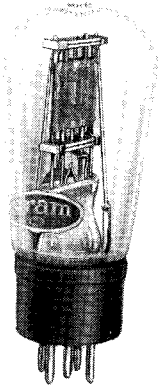

Approx. Dimensions :
 Overall length (including pins)
 135 m/m.
 Maximum diameter of bulb
 51 m/m.

TYPE MH40 TRIODE FOR MICROPHONE AMPLIFIERS (With Indirectly Heated Cathode).

The OSRAM MH40 is an Indirectly Heated Triode suitable for the initial stage of high gain amplifiers.

The outstanding features of type MH40 are its very low order of microphony and background noise, owing to the particularly rigid electrode construction and the use of steatite electrode insulators.

In addition, type MH40 has a high Amplification Factor and Mutual Conductance, thus enabling it to be used with microphones of the condenser, ribbon or velocity type where considerable magnification is required in the first stage.

CHARACTERISTICS.

Heater Volts	4.0
Filament Current	1.0 amp. approx.
Anode Volts	Max. 200 150 100
Grid Volts	-3 -2 -1.5
Anode Current, average	2.7 ma. 2.3 ma. 1.0 ma.
Amplification Factor	45
Impedance	18,750 ohms.
Mutual Conductance	2.4 ma/volt measured at E_A100 , Grid Volts 0.
Automatic Grid Bias Resistance	1,000 ohms.
Optimum Load Resistance	50,000 ohms.

Interelectrode Capacities :

Grid—Anode (others earthed)	7.3 micro-microfarad approx.
Anode—other electrodes	4.0 " " "
Grid—other electrodes	6.0 " " "

For prices see
 pages 126-129.

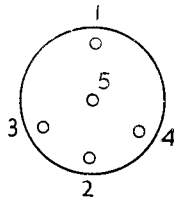

View looking on
 underside of base.

BASE, 5-PIN.

- Pin 1 : Anode
- 2 : Grid
- 3 : Heater
- 4 : Heater
- 5 : Cathode

TYPE MH40

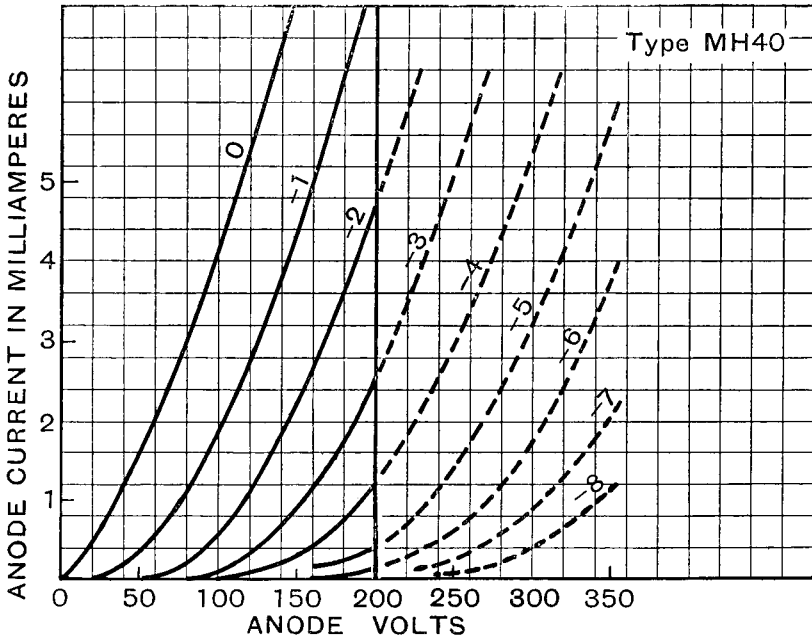

CHARACTERISTIC CURVES
OF
AVERAGE VALVE.

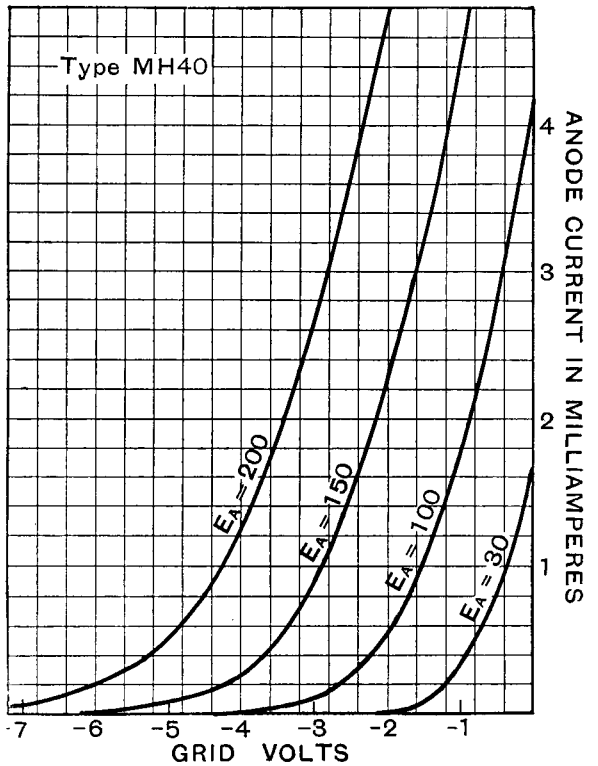

Osram Valves

Made in England.

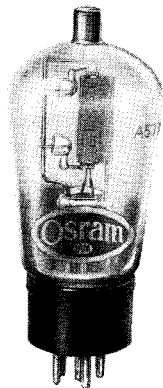

Approx. Dimensions :
Overall length (including pins)
130 m/m.

Maximum diameter of bulb
50 m/m.

TYPE A577

TRIODE FOR VALVE VOLTMETERS With Indirectly Heated Cathode.

The OSRAM A577 triode is designed with characteristics suitable for use in a valve voltmeter which is mains-operated, portable, and capable of operating at high frequencies, and at the same time covering a wide range of voltages. In such an instrument the valve operates as an anode bend rectifier and may be calibrated to read R.M.S. volts on a sinusoidal supply.

Type A577 is suitable for use in such an instrument on all frequencies included in normal radio and audio frequency work, but is not applicable to an audio frequency amplifier.

CHARACTERISTICS.

Heater Volts	4.0	
Heater Current	1.0 amp.	
Anode Volts	250 max.	
Amplification Factor	6	} measured at Ea=100 Eg=0
Impedance	3,000	
Mutual Conductance	2.0 mA/v.	
Input A.C. resistance (measured on a cold valve at 1 megacycle)	20 megohms approx	
Input Capacity	6.0 mmfd. approx.	

For prices see
pages 126-129.

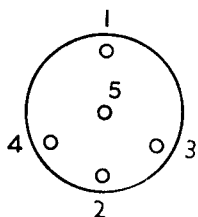

View looking on underside
of valve base

BASE, 5-pin.

- Pin 1: Anode
 - 2: —
 - 3: Heater
 - 4: Heater
 - 5: Cathode
- Top Cap: Grid

OPERATING CONDITIONS.

A typical circuit diagram opposite shows type A577 operating as a self-biased anode bend rectifier.

It is important that the lead from the grid terminal be made as short as possible and if connected to any additional terminal, insulators must be of low loss construction.

The voltmeter may be designed for mains operation or can be run from batteries.

TYPE A577

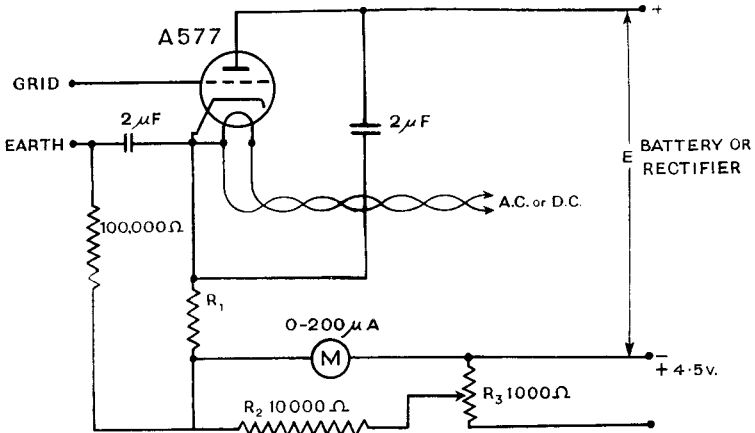

Typical Circuit Diagram.

R_2 and R_3 backing off circuit with zero adjustment on R_3 .
The microammeter M should be short circuited while connecting up the supplies.

Recommended Values (approximate.)

R.M.S. Voltage Range	0-5	0-15	0-50	0-100	0-150
Supply Voltage E (anode + bias)	35	75	270	270	270
Bias Resistance R_1	13,000	60,000	250,000	550,000	800,000
	ohms	ohms	ohms	ohms	ohms

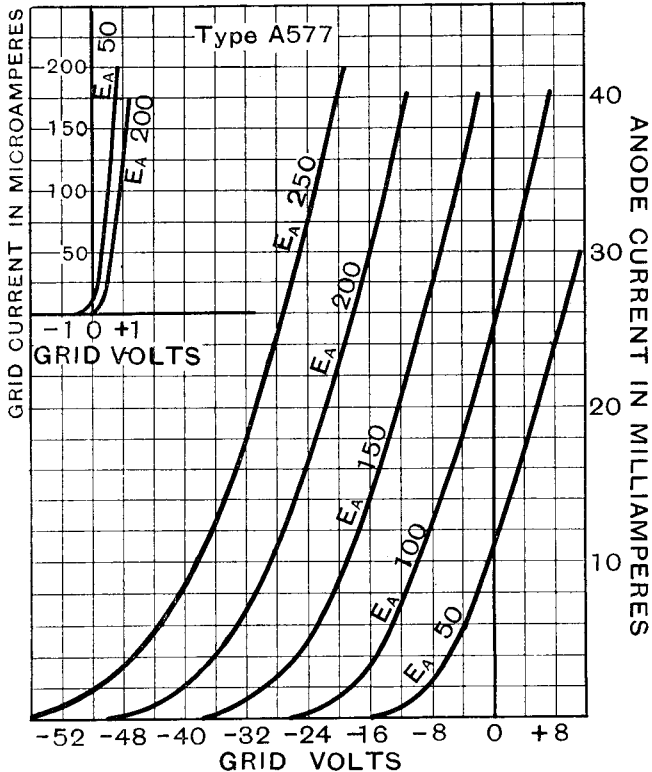

CHARACTERISTIC CURVES OF AVERAGE VALVE.



Made in England.



**GASFILLED RELAY
TYPE GT1
HOT-CATHODE GRID-CONTROLLED
MERCURY VAPOUR RECTIFIER
(Indirectly Heated Cathode).**

The OSRAM GT1 Gasfilled Relay is a trigger device. It comprises an indirectly heated cathode, an anode and a control grid, and is enclosed in a bulb containing mercury vapour. Current is carried through the Relay by the passage of electrons from the cathode to the anode, under the influence of a positive potential applied to the latter. If, however, a sufficiently negative grid bias is applied before the anode is made positive, the flow of current between anode and cathode will be withheld. If the anode voltage is now increased, or the negative grid bias reduced, to a critical ratio (see characteristic curve opposite) a discharge will strike in the mercury vapour and anode current will flow. Under this condition the bulb is filled with the blue glow due to the ionisation of the mercury vapour, and the internal voltage drop between anode and cathode is about 15 volts, irrespective of the value of the anode current. Once ionisation has been produced, the grid has normally no longer any power to control the discharge.

It is essential that the impedance of the external circuit shall of itself be sufficient to limit the anode current to the rating given below.

Maximum Dimensions :
Overall length (including pins)
115 m/m.
Diameter of bulb 50 m/m.

For prices see
pages 126-129.

CHARACTERISTICS.

Heater Voltage	4.0 volts minimum.
Heater Current	1.3 amps. approx.
Maximum Safe Anode Voltage	1,000 volts (peak value).
Maximum Safe Anode Current	1.0 amp. (peak value).
		.5 amp. (R.M.S. value).
		.3 amp. (average value measured on moving coil meter).
Cathode-Anode Voltage Drop	12 to 18 volts.*
Grid Control Ratio	20 to 25.*
Cathode heating time	1 minute.**

* According to temperature.

**After transit, or after a long period of disuse, it is recommended that 5 minutes heating time be allowed.

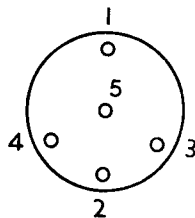

View looking on
underside of base.

BASE: 5-pin.

- 1: Anode
- 2: Grid
- 3: Heater
- 4: Heater
- 5: Cathode

TYPE GT1 OPERATING CONDITIONS.

It is essential that the cathode should be allowed at least one minute to reach full operating temperature before any anode current is permitted to flow. Disregard of this precaution will cause cumulative destruction of the cathode.

It is also essential that the anode current shall never, even momentarily, exceed the rated peak value of 1 amp. This point requires particular attention in circuits where there are condensers which may charge or discharge through the Gasfilled Relay. In circuits where an accidental overload may be liable to occur, it is wise to protect the Gasfilled Relay with an instantaneous overload circuit breaker set to operate at about 1 amp.—a fuse is not sufficiently rapid to afford protection.

A resistance of at least 1,000 ohms should be included in the grid circuit in order to limit the grid current, otherwise the grid circuit impedance should be kept as low as practicable, and at any rate should not exceed 1 megohm.

A large voltage difference between heater and cathode must be avoided; whenever possible, the heater circuit should be connected to the cathode through a resistance of 10 to 1,000 ohms. A floating heater circuit tends to cause irregularity of control.

If the Gasfilled Relay is not in occasional use, it is advisable to heat the cathode to operating temperature for five minutes once every two months, in order to keep the cathode free from mercury.

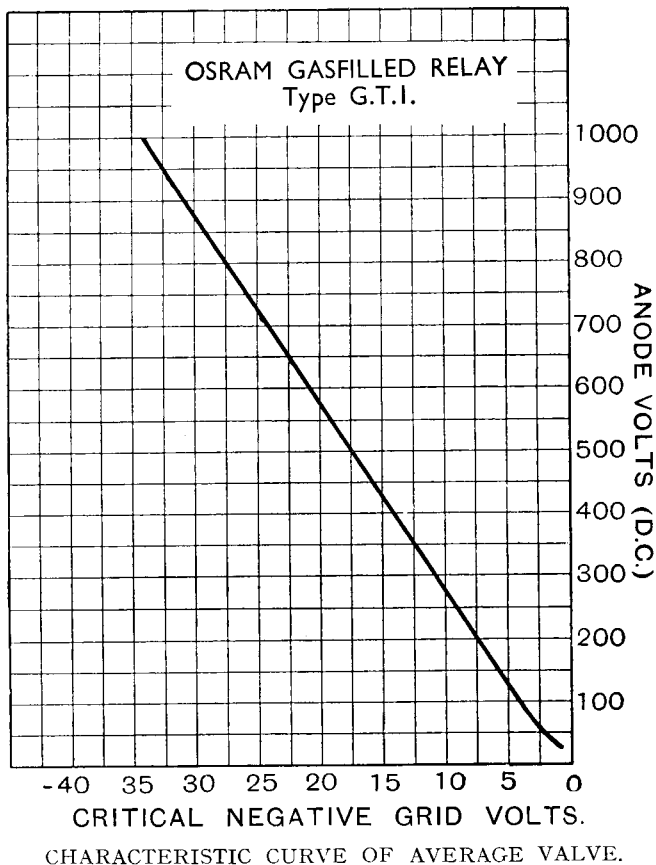

The GT1 can be employed to control currents up to 1 amp. (peak value) in either A.C. or D.C. circuits, and is capable of a variety of applications. In D.C. circuits the anode current can only be stopped by breaking the circuit, or by removing the applied anode voltage for a time long enough to allow of the decay of the ionisation. This may require anything from 10 to 1,000 microseconds, according to circumstances. In A.C. circuits the anode current falls to zero once per cycle; the grid can therefore be made to control the flow of anode current during each cycle and hence the average output power.



Made in England.



Maximum Dimensions :
 Overall length (including pins)
 115 m/m.
 Diameter of bulb 50 m/m.

GASFILLED RELAY
TYPE GT1A.
ARGON FILLED GRID-CONTROLLED
RECTIFIER

(Indirectly Heated Cathode)

The OSRAM GT1A Gasfilled Relay comprises an indirectly heated cathode, an anode, and a control grid, and is enclosed in a bulb filled with argon.

Current is carried through the Relay by the passage of electrons from Cathode to Anode, under the influence of a positive anode potential. By application of a sufficiently large negative grid bias, the flow of anode current will be withheld until either the anode voltage is increased, or the negative grid voltage reduced to a critical ratio. Once the discharge has been produced the grid has normally no longer any power to control it.

The use of a permanent gas filling such as argon in place of mercury vapour ensures a practically constant characteristic under normal variations of room temperature.

CHARACTERISTICS :

Heater Voltage	4.0 volts minimum
Heater Current	1.3 amp. approx.
Maximum Safe Anode Voltage	300 volts (peak value)
Maximum Safe Anode Current	0.6 amp. (peak value)
		.3 amp. (R.M.S. value)
		.2 amp. (measured on moving coil meter)
Anode-Cathode Voltage Drop	15 volts
Grid Control Ratio	20
Cathode heating time..	30 seconds minimum

For prices see
 pages 126-129.

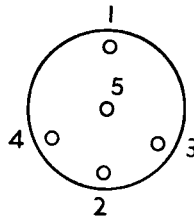

View looking on
 erside of base.

BASE, 5-pin.
 Pin 1 : Anode
 2 : Grid
 3 : Heater
 4 : Heater
 5 : Cathode

TYPE GT1A.

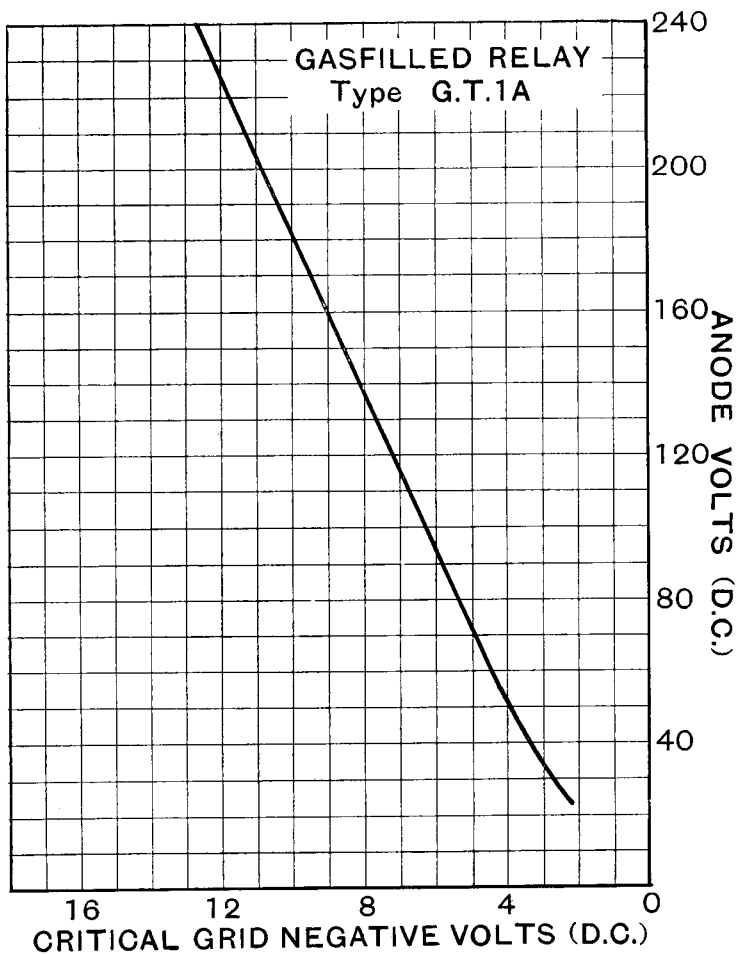

CHARACTERISTIC CURVE OF AVERAGE VALVE.

OPERATING CONDITIONS :

It is essential that the cathode should be allowed at least 30 seconds to reach full operating temperature before any anode current is allowed to flow. Disregard of this precaution will cause cumulative destruction of the cathode, and change of characteristics due to clean-up of the gaseous filling.

It is also essential that the anode current shall never, even momentarily, exceed the ratio peak current of 0.6 ampere. This requires particular attention in circuits where condensers may charge or discharge through the gasfilled relay.

A large voltage difference between heater and cathode should be avoided. A floating heater circuit tends to cause irregularity of control. A resistance of at least 1,000 ohms should be included in the grid circuit in order to prevent excessive grid currents. It is recommended that the total impedance of the grid circuit be kept below 100,000 ohms.

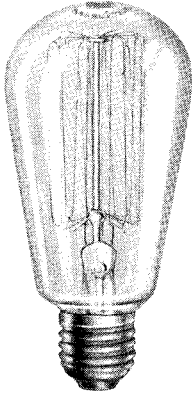

Made in England.

BARRETTERS CURRENT REGULATORS

(For use in series with 0.3 amp. Valves).

Approx. Dimensions :
Overall length 130 m/m.
Maximum diameter of bulb
64 m/m.

**For prices see
pages 126-129.**

OSRAM BARRETTERS are designed to maintain the current passing through them substantially constant within certain limits, although fluctuating values of voltage be applied across the barretter in series with the load.

They may thus be employed with advantage to obviate the necessity for an external tapped resistance in receivers operating from A.C. or D.C. Mains in which the valve heaters are wired in series and the full heater current is drawn from the mains without (in the case of A.C. Mains) the intervention of a filament transformer.

OSRAM BARRETTERS for use with 0.3 amp. valves are supplied in four types, as follow :

CHARACTERISTICS.

Mean Current 0.3 ampere.

Type 301	Voltage Range	138-221
Type 302	„ „	112-195
Type 304	„ „	95-165
Type 303	„ „	86-129
Cap	Standard Edison Screw	

OPERATING CONDITIONS.

Barretters types 301, 302 and 304 accommodate the regulation of from three to seven 0.3 amp. heaters in series respectively for a mains supply range of from 190 to 260 volts.

In the case of Barretter type 303, however, when employed on a voltage supply of from 230 to 260 volts a small additional series resistance of approximately 150 ohms is required.

In operation, ample air circulation should be allowed round the Barretter. Care should be taken in handling as the bulb becomes hot on circuit and remains so for some time after the current is switched off. Approximately five minutes should be allowed for the Barretter to settle to its steady current regulation.

OSRAM 0.3 AMP. BARRETTERS

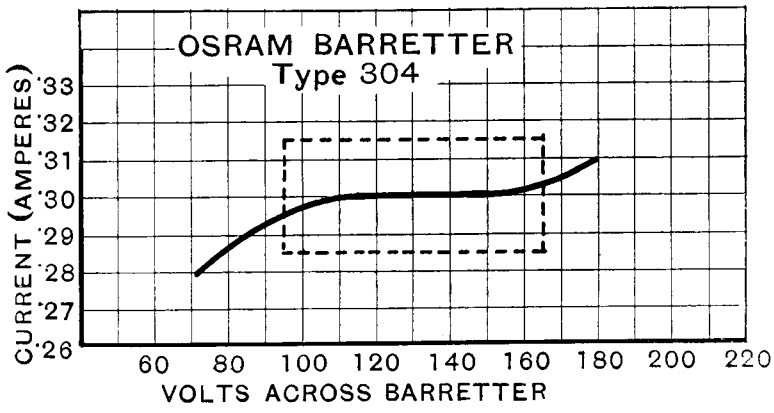
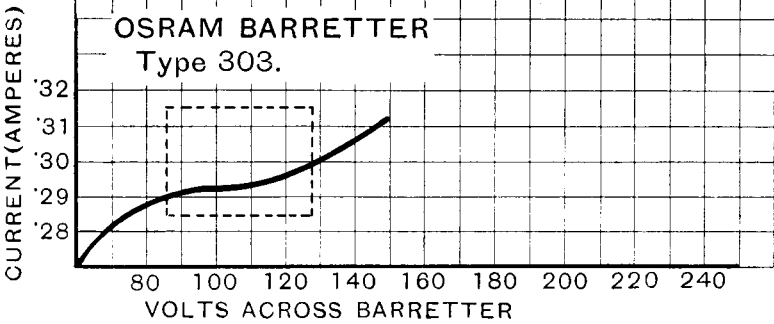
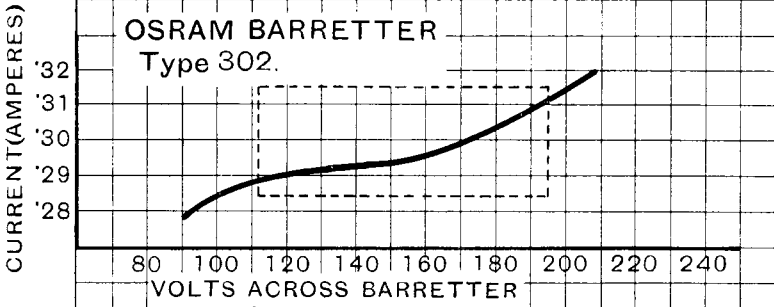
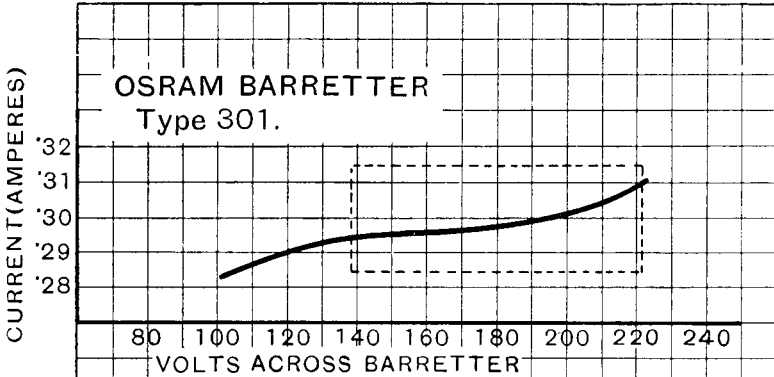



Made in England.

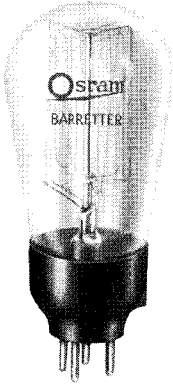

BARRETTTER TYPE 202 CURRENT REGULATOR

(For use in series with 0.2 amp. valves).

OSRAM Barretters are designed to maintain the current passing through them substantially constant within certain limits, although fluctuating values of voltage can be applied across the Barretter in series with the load.

They may thus be employed with advantage to obviate the necessity for an external tapped resistance in receivers operating from A.C. or D.C. Mains in which the valve heaters are wired in series and the full heater current is drawn from the mains without (in the case of A.C. Mains) the intervention of a filament transformer.

OSRAM Barretters are designed for reliable operation and long life.

Maximum Dimensions :
Overall length (including pins)
145 m/m.
Diameter of bulb 60 m/m.

CHARACTERISTICS.

Mean Current	0.2 ampere
Voltage Range	120 to 200

For prices see
pages 126-129.

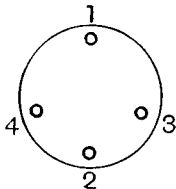

View looking on
underside of base.

CAP, 4-PIN

- 1: —
- 2: —
- 3: Filament
- 4: Filament

This type can also be supplied fitted with a standard Edison Screw Cap.

BARRETTTER

TYPE 202

OPERATING CONDITIONS.

In operation, ample air circulation should be allowed round the Barretter. Care should be taken in handling as the bulb becomes hot on circuit and remains so for some time after the current is switched off. Approximately five minutes should be allowed for the Barretter to settle to its steady current regulation.

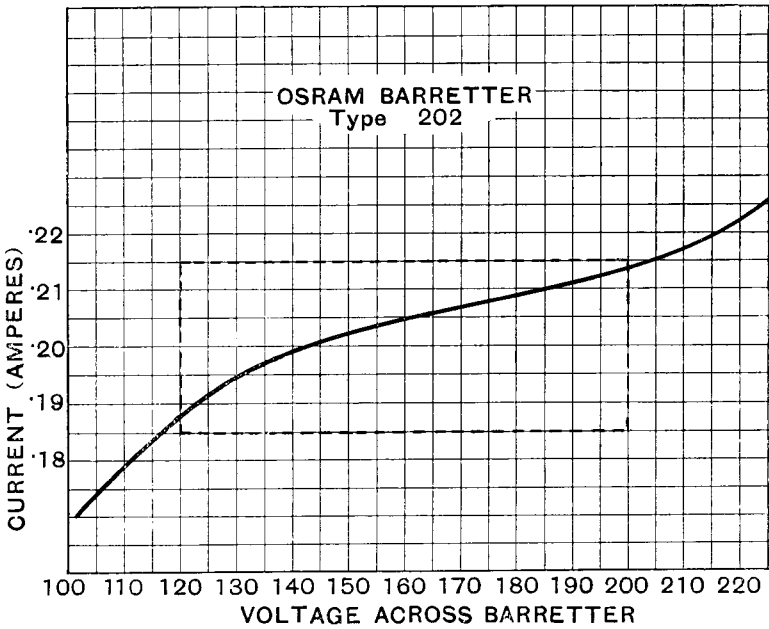

G.E.C.

TUNEON INDICATOR NEON FILLED 3-ELECTRODE TUNING INDICATOR.

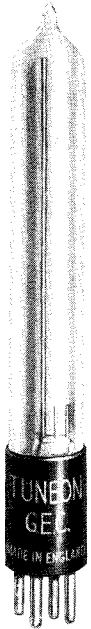

Approx. Dimensions :
Overall length (including pins)
115 m/m.
Maximum diameter of bulb
13 m/m.

The G.E.C. TUNEON INDICATOR consists of a neon-filled tube containing three electrodes ; two short and the third long, and is intended for use as a visual indication of the correct tuning point in an A.V.C. receiver. On the passage of a small current through the tube a luminous glow appears on the long electrode. If the tube is connected in a suitable circuit correct tuning is indicated when this glow is of maximum length.

CHARACTERISTICS.

Striking Voltage	165 approx.
Cover Voltage	180 approx.
Current at commencement of glow ..	0.15 mA approx.
Normal Operating Current	1.4 mA approx.

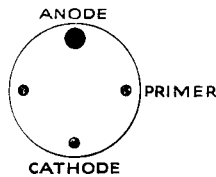

VIEW LOOKING AT END OF PINS

BASE :

Miniature 4 pin connections as shown in diagram.
Also supplied fitted with S.B.C cap cathode to metal shell anode and primer to the two contacts.

For prices see
pages 126-129.

Dimensions with S.B.C. Cap.
Overall length including cap .. 105 m/m.
Maximum diameter 13 m/m.

TYPICAL CIRCUIT.

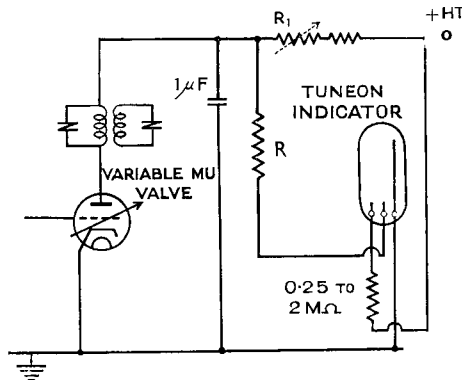

R_1 = 20,000 to 80,000 ohms (5,000 ohms minimum) depending on the H.T. voltage available.

R = 10,000 to 60,000 ohms depending upon range of current variation given by controlled valve.

G.E.C.

BUTTON TUNEON

NEON FILLED 2-ELECTRODE TUNING INDICATOR.



Illustration full size.

Approx. Dimensions :

Overall length (including cap)
27.5 m/m.

Diameter of bulb 12.5 m/m.

The G.E.C. BUTTON TUNEON consists of a neon-filled tube containing two electrodes, and is intended for a simple indication of the correct tuning point in a Radio Receiver.

As distinct from the Tuneon Indicator the correct tuning point is shown by the degree of brightness of the glow alone, and not by a combination of brightness and length. It may be used in circumstances where the restriction of space does not allow of the use of a standard Tuneon.

CHARACTERISTICS.

Striking Voltage	180 approx.
Extinguishing Voltage	165 approx.
Normal Operating Current	0.5 mA approx.*

*Resistances should be so adjusted that full glow current never exceeds 0.7 m.a. otherwise tube will rapidly blacken.

For prices see
pages 126-129.

BASE :

S.E.S. cap.
Centre contact—disc.
Barrel of cap—ring.

TYPICAL CIRCUIT.

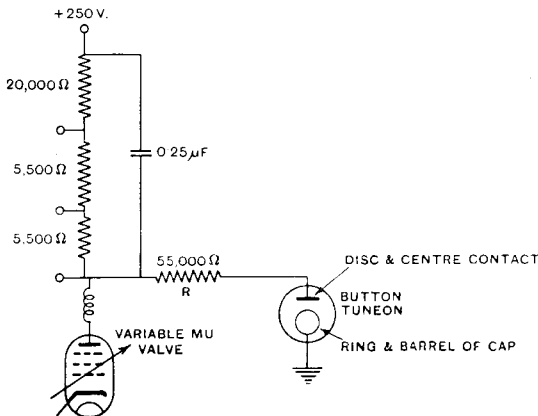

The resistance values given in diagram above may be varied to accommodate different types of variable mu valves and R should be adjusted so that the Button Tuneon just glows on no signal. The maximum current for full brightness should not be exceeded to ensure satisfactory life.

OSRAM VALVES
SCHEDULE OF TYPES FOR BROADCAST RECEIVERS AND PRICE LIST
 (Types in italics are not normally stocked, but are available for replacement purposes, if required.)

Type	Description.	Price.		Filament		Amplification Factor.	Impedance ohms.	Mutual Conductance ma/volt.	Anode Volts max.	Screen Volts max.	Base.	Finish M = Metallised P = Plain.	Type.
		s.	d.	Volts	Current amp.								
Battery Valves.													
2-volt	Heptode Frequency Changer ..	14	0	2.0	0.1	—	—	Conversion Conductance 240 micromhos	150	70	7-pin	M or P	X.21
S.23	Screen Grid ..	11	0	2.0	0.1	300,000	1.1	150	70	4-pin	M or P	S.23	
S.24	Screen Grid ..	11	0	2.0	0.15	300,000	1.4	150	70	4-pin	M or P	S.24	
V.S.24	Variable Mu Screen Grid ..	11	0	2.0	0.15	250,000	1.5	150	75	4-pin	M or P	V.S.24	
V.S.24/K	Variable Mu Screen Grid ..	12	6	2.0	0.15	250,000	1.5	150	75	4-pin	M or P	V.S.24/K	
VP.21	Variable Mu Screen Pentode ..	11	0	2.0	0.1	1,000,000	1.1	150	60	7-pin	M	VP.21	
HL.2	Triode Detector or L.F. ..	4	9	2.0	0.1	18,000	1.5	150	—	4-pin	M or P	HL.2	
<i>HL.210</i>	<i>General Purpose Triode..</i>	5	6	2.0	0.1	20,000	1.2	150	—	4-pin	M or P	<i>HL.210</i>	
<i>H.210</i>	<i>Triode Detector and R.C.</i>	4	9	2.0	0.1	50,000	0.7	150	—	4-pin	M or P	<i>H.210</i>	
<i>H2</i>	<i>Triode ..</i>	4	9	2.0	0.1	35,000	1.0	150	—	4-pin	P	<i>H2</i>	
L.21	L.F. Triode ..	9	0	2.0	0.1	8,900	1.8	150	—	4-pin	M or P	L.21	
HD.22	Double Diode Triode ..	9	0	2.0	0.2	18,000	1.5	150	—	5-pin	M or P	HD.22	
LP.2	L.F. and Power..	6	0	2.0	0.2	3,900	3.85	150	—	4-pin	P	LP.2	
<i>P.215</i>	<i>L.F. and Power ..</i>	7	0	2.0	0.15	5,000	1.4	150	—	4-pin	P	<i>P.215</i>	
P.2	Super Power ..	10	0	2.0	0.2	2,150	3.5	150	—	4-pin	P	P.2	
PT.2	L.F. Pentode ..	11	0	2.0	0.2	—	2.5	150	150	5-pin	P	PT.2	
QP.21	Double Pentode..	17	6	2.0	0.4	—	—	150	150	7-pin	P	QP.21	
B.21	Double Triode "Class B"	11	0	2.0	0.2	—	—	150	—	7-pin	P	B.21	
A.C. Mains Valves, Indirectly Heated.													
MX.40	Heptode Frequency Changer ..	15	0	4.0	1.0	—	—	Conversion Conductance 500 micromhos	250	100	7-pin	M or P	MX.40
X.41	Triode Hexode Frequency Changer ..	15	0	4.0	1.2	—	—	490 micromhos	250	80	7-pin	M or P	X.41
X.42	Heptode Frequency Changer ..	15	0	4.0	0.6	—	—	micromhos	250	100	7-pin	P	X.42
<i>MS.4</i>	<i>Screen Grid ..</i>	12	6	4.0	1.0	500,000	1.1	250	70	5-pin	M or P	<i>MS.4</i>	
MS.4.B	Screen Grid ..	12	6	4.0	1.0	350,000	3.2	250	80	5-pin	M or P	MS.4.B	
VMS.4	Variable Mu Screen Grid ..	12	6	4.0	1.0	250,000	2.4	250	80	5-pin	M or P	VMS.4	
VMS.4.B	Variable Mu Screen Grid ..	12	6	4.0	1.0	250,000	2.9	250	80	5-pin	M or P	VMS.4.B	
VMP.4.G	Variable Mu Screen Pentode ..	12	6	4.0	1.0	—	2.8	250	100	7-pin	M	VMS.4.B	
<i>VMP.4</i>	<i>Variable Mu Screen Pentode ..</i>	17	6	4.0	1.0	—	3.5	200	100	5 and 7-pin	M or P	<i>VMP.4</i>	
W.42	Variable Mu Screen Pentode ..	12	6	1.0	0.6	—	1.75	250	125	7-pin	P	W.42	
WD.40	Vari-Mu Screen Pentode Double Diode ..	20	0	4.0	1.0	—	2.6	250	100	9-pin	M	WD.40	
MSP.4	Screen Pentode ..	12	6	4.0	1.0	—	4.0	250	100	5 and 7-pin	M or P	MSP.4	
MSP.41	Screen Pentode ..	15	0	4.0	1.0	—	3.2	250	240	7-pin	M or P	MSP.41	

OSRAM VALVES

SCHEDULE OF TYPES FOR BROADCAST RECEIVERS AND PRICE LIST

(Types in italics are not normally stocked, but are available for replacement purposes, if required.)

Type.	Description.	Price.	Heater	Amplification Factor.	Impedance ohms.	Mutual Conductance ma/volt.	Anode Volts max.	Screen Volts max.	Base.	Finish M = Metallised. P = Plain.	Type.
<i>—continued.</i>											
A.C. Mains Valves, Indirectly Heated											
MH.4	Triode Detector and L.F.	9 6	4.0	40	11,000	3.6	250	—	5-pin	M or P	MH.4
H42	Triode ..	9 6	4.0	100	66,000	1.7	250	—	7-pin	P	H42
MH.41	Triode ..	9 6	4.0	80	13,300	6.0	250	—	5-pin	M or P	MH.41
MHL.4	Triode ..	13 6	4.0	20	8,000	2.5	250	—	5-pin	M or P	MHL.4
ML.4	Triode ..	10 0	4.0	12	2,860	4.2	250	—	5-pin	M or P	ML.4
MHD.4	Double Diode Triode ..	12 6	4.0	40	18,200	2.2	250	—	7-pin	M or P	MHD.4
D.41	Double Diode ..	5 6	4.0	—	—	—	—	—	5-pin	M or P	D.41
MPT.4	L.F. Pentode ..	13 6	4.0	—	—	3.0	250	200	5 & 7-pin	P	MPT.4
MPT.4—	L.F. Pentode ..	18 6	4.0	—	—	3.0	250	250	5 and 7-pin	P	MPT.4—
Cathin											
N.41	Output Pentode..	13 6	4.0	—	—	10.0	250	250	7-pin	P	N.41
N42	Output Pentode..	13 6	4.0	—	—	2.5	250	250	7-pin	P	N42
DN.41	Double Diode-Output Pentode	16 0	4.0	—	—	10.0	250	250	7-pin	P	DN.41
A.C. Mains Valves, Directly Heated.											
PX.4	Triode, 12-watt ..	12 6	4.0	5	830	6.0	250	—	4-pin	P	PX.4
PX.25	Triode, 25-watt ..	25 0	4.0	9.5	1,265	7.5	400	—	4-pin	P	PX.25
PX.25A	Triode, 25-watt ..	25 0	4.0	4	580	6.9	400	—	4-pin	P	PX.25A
PT.25	<i>Pentode, 8-watt ..</i>	18 6	4.0	120	42,000	2.85	250	250	5-pin	P	PT.4
PT.25	<i>Pentode, 25-watt ..</i>	45 0	4.0	100	25,000	4.0	400	200	5-pin	P	PT.25
PT.25H	Pentode, 25-watt ..	45 0	4.0	180	28,000	6.5	400	400	5-pin	P	PT.25H
DA.30	Triode, 30-watt ..	30 0	4.0	4	580	6.9	500	—	4-pin	P	DA.30
DA.60	Triode, 60-watt ..	110 0	6.0	2.5	835	3.0	500	—	Special	P	DA.60
DA.100	Triode, 100-watt ..	210 0	6.0	5.5	1,410	3.9	1000	—	Special	P	DA.100
Universal Range, D.C./A.C.											
X.32 & X.30	Heptode Frequency Changer ..	15 0	13.0	—	—	Conversion Conductance 750 micromhos	250	100	7-pin	M	X.32 & X.30
X.31	Triode Hexode Frequency Changer ..	15 0	13.0	—	—	550 micromhos	250	80	7-pin	M	X.31
W.30	Vari-Mu H.F. Screen Pentode ..	12 6	13.0	—	—	4.0 micromhos	250	250	7-pin	M	W.30
W.31	Vari-Mu Screen Pentode ..	12 6	13.0	—	—	2.78	200	100	7-pin	M	W.31
WD.30	Vari-Mu Screen Pentode-D.D.	20 0	13.0	—	—	2.6	250	100	9-pin	M	WD.30
H.30	Triode ..	9 6	13.0	80	13,300	6.0	250	—	7-pin	M or P	H.30
DH.30	D.D.-Triode ..	12 6	13.0	80	18,000	4.5	200	—	7-pin	M or P	DH.30
D.41	Double Diode ..	5 6	4.0	—	—	—	—	—	5-pin	M or P	D.41
N.30	Output Pentode..	13 6	13.0	—	—	3.9	250	250	7-pin	P	N.30
N30G	Output Pentode..	13 6	26.0	—	—	10.0	200	180	7-pin	P	N30G
N.31	Output Pentode..	13 6	26.0	—	—	—	—	—	7-pin	P	N.31

OSRAM VALVES

SCHEDULE OF TYPES FOR BROADCAST RECEIVERS AND PRICE LIST

(Types in italics are not normally stocked, but are available for replacement purposes, if required.)

Type.	Description.	Price.		Heater		Amplification Factor.	Impedance ohms.	Mutual Conductance ma/volt.	Anode Volts max.	Screen Volts max.	Base.	Finish M=Metallised. P=Plain.	Type.
		s.	d.	Volts	Current amp.								
D.C. Mains Range (0.25 amp).													
<i>D.S</i>	<i>Screen Grid</i>	17	6	16.0	0.25	550	500,000	1.1	200	70	5-pin	M or P	DS
DSB	<i>Screen Grid</i>	17	6	16.0	0.25	1120	350,000	3.2	200	80	5-pin	M or P	DSB
VDS	<i>Variable-Mu Screen Grid</i>	17	6	16.0	0.25	—	—	2.4	200	80	5-pin	M or P	VDS
VDSB	<i>Variable-Mu Screen Grid</i>	17	6	16.0	0.25	—	—	3.0	200	80	5-pin	M or P	VDSB
DHD	<i>D.D.-Triode</i>	15	6	16.0	0.25	40	18,200	2.2	200	—	7-pin	M or P	DHD
DH	<i>Triode</i>	13	6	16.0	0.25	40	10,800	3.7	200	—	5-pin	M or P	DH
DL	<i>Triode L.F.</i>	14	0	16.0	0.25	12	2,660	4.5	200	—	5-pin	P	DL
DPT	<i>Output Pentode</i>	18	6	16.0	0.25	—	—	3.0	200	200	5 or 7-pin	P	DPT

Rectifiers

Type.	Description.	Price.		Filament Volts.	Current amps.	Anode Volts R.M.S. max.	Rectified Current m.a. max. (Smoothed with a 4 mfd. condenser).	Base.	Type.
		s.	d.						
<i>U.5</i>	<i>Directly Heated Full Wave</i>	30	0	5.0	1.6	400+400	45	4-pin	U.5
<i>U.8</i>	<i>Directly Heated Full Wave</i>	30	0	7.5	2.4	500+500	120	4-pin	U.8
U.10	Directly Heated Full Wave..	10	6	4.0	1.0	250+250	60	4-pin	U.10
U.12	Directly Heated Full Wave..	10	6	4.0	2.5	350+350	120	4-pin	U.12
U.14	Directly Heated Full Wave..	15	0	4.0	2.5	500+500	120	4-pin	U.14
U.18	Directly Heated Full Wave..	25	0	4.0	3.75	500+500	250	4-pin	U.18
MU.12	Indirectly Heated Full Wave	10	6	4.0	2.5	350+350	120	4-pin	MU.12
MU.14	Indirectly Heated Full Wave	15	0	4.0	2.5	500+500	120	4-pin	MU.14
U.30	Indirectly Heated for Universal Range : Half Wave .. Voltage Doubler .. Full Wave ..	15	0	26.0	0.3	180	120	7-pin	U.30
U.16	Directly Heated Half Wave	20	0	13.0	0.6	250	75	4-pin	U.16
U.17	Directly Heated Half Wave	20	0	2.0	0.25	5000	2.0	4-pin	U.17
GU.1	Mercury Vapour Half Wave	25	0	4.0	3.0	1000	30	4-pin	GU.1
GU.5	Mercury Vapour Half Wave	25	0	4.0	3.0	1500	250	4-pin	GU.5

OSRAM VALVES
SCHEDULE OF TYPES FOR BROADCAST RECEIVERS AND PRICE LIST

Special Types.

Type.	Description.	Price.	Filament.	Amplification Factor.	Impedance ohms.	Mutual Conductance ma/volt.	Anode Volts max.	Screen Volts max.	Base.	Finish.	Type.
HA1	Low Capacity Triode (Acorn)	s. d. 50 0	0.3	20	11,700	1.7	180	—	Special	M	HA1
N43	Output Pentode (H.F.)	25 0	4.0	—	—	10.0	250	250	7-pin	P	N43
D42	Indirectly Heated Single Diode	10 0	4.0	—	—	—	75	—	4-pin	P	D42
H.11	Midget Amplifying Triode	15 0	1.0	15	30,000	0.5	100	—	Small side contact	P	H.11
L.11	Midget Amplifying Triode	15 0	1.0	5	12,500	0.4	100	—	—	P	L.11
A.537	Triode for Microphone Amplifiers	50 0	4.0	15.5	10,000	1.55	150	—	—	P	A.537
MH40	Triode for Microphone Amplifiers	50 0	4.0	45	18,750	2.4	200	—	5-pin	P	MH40
GT1	Gasfilled Relay (Mercury filled)	40 0	4.0	—	—	—	1000	—	5-pin	P	GT.1
GT1A	Gasfilled Relay (Argon-filled)	60 0	4.0	—	—	—	300	—	5-pin	P	GT1A
A577	Triode for Valve Voltmeters	60 0	4.0	6	3,000	2.0	250	—	5-pin	P	A577

BARRETTERS.

Type.	Description.	Price.	Voltage range.
301	For control of current 0.3 amp.	s. d. 8 6	138—221
302	"	8 6	112—195
303	"	8 6	86—129
304	"	8 6	95—165
251	For control of current 0.25 amp.	12 6	100—180
202	For control of current 0.2 amp.	8 6	120—200

TUNEON INDICATOR .. Price each 4/-.. Base.—Miniature 4-pin or S.B.C.
BUTTON TUNEON .. Price each 2/6.. Base.—S.E.S. Cap.

PIN CONNECTIONS

(All views looking on underside of valve base).

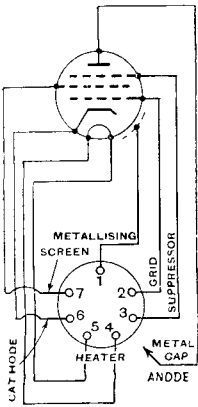

SCREEN PENTODES
 VMP4. VMP4K.
 VMP4G. MSP4.
 W30. W31.
 VP21 (Pin 6 Blank)

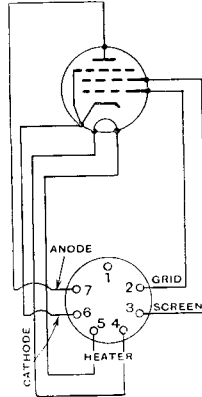

L.F. PENTODES
 MPT4. MPT4 (Catkin)
 DPT. N41. N30
 N42

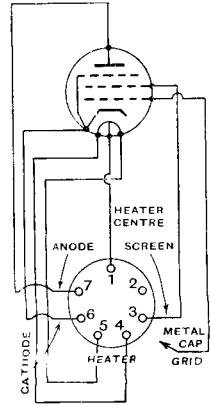

L.F. PENTODES WITH
 GRID TOP CAP.
 N31 N43
 (Pin 1 Blank in N43)

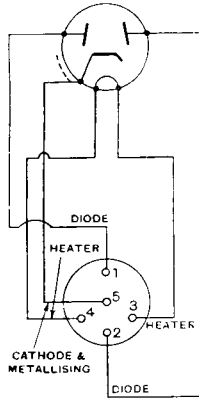

DOUBLE DIODE
 D41

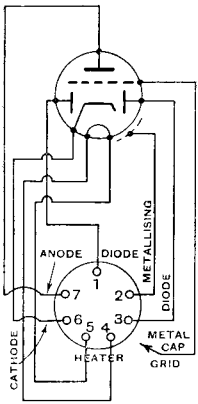

DOUBLE DIODE
 TRIODES
 MHD4
 DHD
 DH30

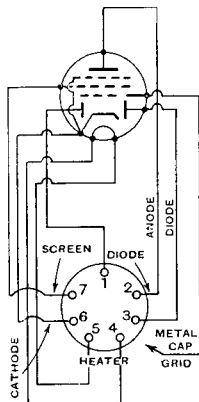

DOUBLE DIODE
 L.F. PENTODE
 DN41

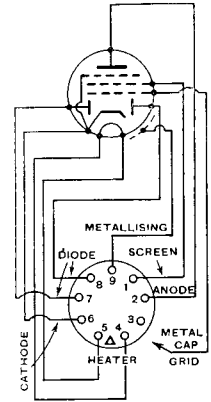

DOUBLE DIODE
 SCREEN PENTODES
 WD40
 WD30

PIN CONNECTIONS

(All views looking on underside of valve base.)

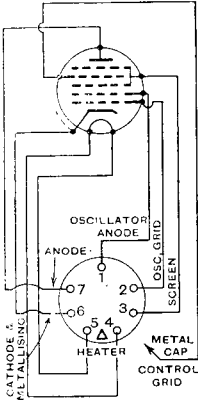

HEPTODES

MX40

X30, X32

X21 (Pin 6 Blank)

X42

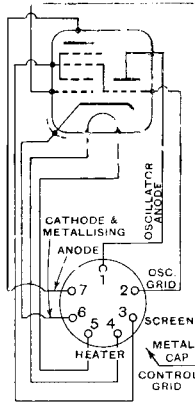

TRIODE-HEXODES

X41

X31

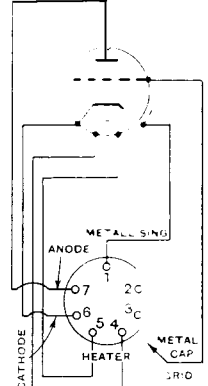

TRIODES WITH GRID
TOP CAP.

H30

H42

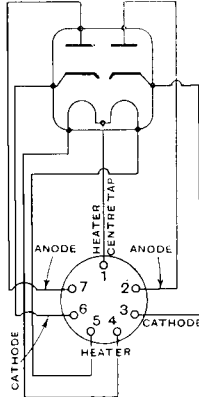

UNIVERSAL RANGE
RECTIFIER

U30

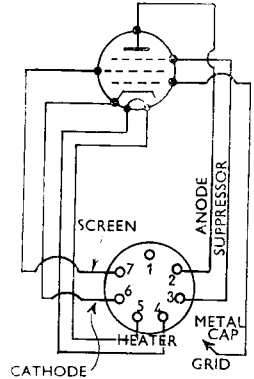

SCREEN PENTODES
WITH GRID TOP CAP.

W42

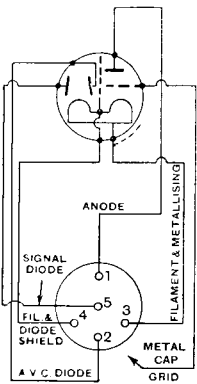

BATTERY
DOUBLE DIODE-TRIODE

HD22

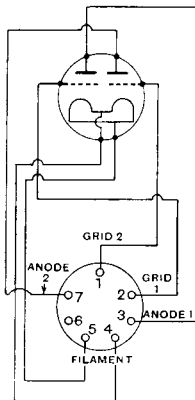

DOUBLE TRIODE
"CLASS B"

B21

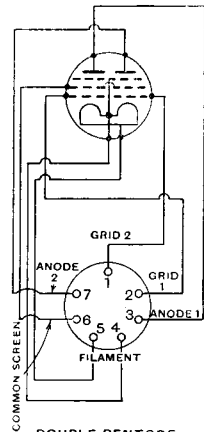

DOUBLE PENTODE

QP21

Osram Valves

INDEX.

2-VOLT BATTERY VALVES.		Page		Page
S23	4	DA30 66
S24	4	DA100 68
VS24	6	UNIVERSAL D.C.—A.C. VALVES & CAR RADIO VALVES.	
VS24/K	6	W31 72
VP21	8	X30, X32 74
X21	10	X31 76
HL2	12	D41 78
L21	12	DH30 78
HD22	14	H30 80
LP2	16	L30 80
P2	16	N30/G 82
PT2	18	N31 84
QP21	20	RECTIFIERS.	
A.C. MAINS VALVES.			U12 88
Indirectly Heated :—			U14 88
MS4B	24	MU12 90
VMS4	26	MU14 90
VMS4B	26	U18 92
VMP4G	28	U30 94
W42	30	U16 96
MSP4	32	U17 98
MSP41	32	GU1 100
MX40	34	GU5 100
X41	36	SPECIALS.	
X42	38	D42 104
D41	40	N43 106
MHD4	42	HA1 108
MH4	44	A537 110
H42	46	MH40 112
MHL4	48	A577 114
ML4	50	GT1 116
MPT4	52	GT1A 118
N41	54	BARRETTERS.	
N42	56	301, 302, 303, 304 120
DN41	58	202 122
Directly Heated :—			Tuneon Indicator 124
PX4	60	Button Tuneon.. 125
PX25	62	SCHEDULE OF TYPES & PRICE LIST .. 126—129	
PX25A	64	Pin Connections .. 130—131	