

The Series of books on Electronic Valves includes :

- Book I Fundamentals of Radio Valve Technique
 547 pages, 6'' × 9'', 384 illustrations.
- Book II Data and Circuits of Radio Receiver and Amplifier Valves
 424 pages, 6'' × 9'', 531 illustrations (1933/39).
- Book III Idem, 220 pages, 6'' × 9'', 267 illustrations (1940/41).
- Book IIIA Idem, 487 pages, 505 illustrations (1945/50)
- Book IIIB Idem, 1951/52, in preparation.
- Book IIIC Idem, on Television Valves, in preparation.
- Book IV Application of the Electronic Valve in Radio Receivers and
 Amplifiers (Part 1)
 1) R.F. and I.F. amplification 2) Frequency changing 3) Deter-
 mination of the tracking curve 4) Interference and distortion
 due to curvature in characteristics of the receiving valves
 5) Detection.
 440 pages, 6'' × 9'', 256 illustrations.
- Book V Application of the Electronic Valve in Radio Receivers and
 Amplifiers (Part 2)
 6) A.F. amplification 7) Output stage 8) Power supply
 434 pages, 6'' × 9'', 343 illustrations.
- Book VI Application of the Electronic Valve in Radio Receivers and
 Amplifiers (Part 3) (in preparation).
 9) Inverse feedback 10) Control devices 11) Stability and insta-
 bility of circuits 12) Parasitic feedback 13) Interference phe-
 nomena (hum, noise and microphony) 14) Calculation of
 receivers and amplifiers.
- Book VII Transmitting Valves, 284 pages, 6'' × 9'', 256 illustrations.
- Book VIIIA Television Receiver Design 1.
 I.F. Stages.
- Book VIIIB Television Receiver Design 2.
 Flywheel synchronization of saw tooth generators.

BOOK IIIA

**DATA AND CIRCUITS
OF RADIO RECEIVER
AND AMPLIFIER VALVES**

(Second supplement)

Valves developed during the period 1945/50

DISTRIBUTORS FOR UNITED KINGDOM :

CLEAVER HUME PRESS LTD

42a SOUTH AUDLEY STREET - LONDON W 1

U.S.A. AND CANADA :

ELSEVIER PRESS INC.

402 LOVETT BOULEVARD - HOUSTON 6 (TEXAS)
300 PARK AVENUE - NEW YORK CITY

DATA AND CIRCUITS OF RADIO RECEIVER AND AMPLIFIER VALVES

(Second supplement)
621.385:621.396.694

Compiled and Edited by

N. S. MARKUS AND J. OTTE

This publication furnishes a review, with full descriptions and data, of receiver, amplifier and rectifier valves developed during the period 1945-1950, together with their applications and circuits. A large variety of receiver and amplifier circuits employing the valves under review is also provided. This book further contains descriptions of measuring instruments and auxiliary equipment for use in the laboratory, testing department and factory, as at December 31 1950.

PHILIPS TECHNICAL LIBRARY

The English translation of this book is by: J. F. HAVINGA - LONDON

Publisher's note:

This work has been published in: Dutch, English, French and German.

All rights reserved by N.V. Philips' Gloeilampenfabrieken, Eindhoven (Holland).

All data in this book are given without prejudice to patent rights of the above company.

English edition first published in 1952.

Printed in the Netherlands.

Foreword

This book contains descriptions and data of the receiving and amplifying valves brought out by Philips in the post-war years 1945-1950, and is a sequel to Books II and III of the Series covering 1933-1939 and 1940-1941 respectively. Rimlock-valves take a prominent place, together with the miniature battery valves and various Noval types, in which class the EQ 80 is an important newcomer for F.M. and A.M./F.M. receivers.

As in the earlier books of the series, considerable space is devoted to applications of the new valves, illustrated with many circuit diagrams of receivers. The graphs are reproduced on a larger scale than before, so as to make them more legible and useful to the set-designer, service dealer and student. Descriptions of the latest measuring instruments and of auxiliary equipment for use in laboratories, testing stations and factories are again included.

The book was compiled from data contributed by many experts in the Philips Laboratories and Factories. We have to thank Mr. J. F. Havinga, London, for the English translation and Mr. F. M. Walker, London, for checking the English manuscript.

The Authors

Eindhoven, June 1952

Index

	Page
Foreword	07
Index	09
Explanations relating to the technical data of Philips receiving and amplifying valves 1	
List of symbols	8
Introduction	11
“Miniwatt” Rimlock valves	14
Features of the Rimlock valves	15
Dimensions of the Rimlock valves	15
Simplicity of construction	16
Self-locating and locking of Rimlock valves	16
The Rimlock valveholder	17
Classification of the Rimlock valves.	20
Rimlock valves for radio receivers	21
The E-series of Rimlock valves	21
Classification of Rimlock E-type radio valves according to function	22
Receivers employing Rimlock E-type valves	25
AZ 41 Full-wave rectifying valve	27
EAF 42 (EAF 41) Diode-pentode	30
EB 41 Double diode	53
EBC 41 Double diode-triode	57
ECH 41 Triode-hexode frequency changer	64
ECH 42 Triode-hexode frequency changer	76
EF 41 Variable- μ R.F. pentode	90
EL 41 9 W output pentode	97
EL 42 Low-consumption output pentode	106
EZ 40 Full-wave rectifier	115
EZ 41 Full-wave rectifier	119
I Five-valve A.C. superheterodyne receiving circuits using two valves EAF 42.	121
II A superhet with 4 Rimlock valves and separate power units for battery and A.C. mains	132
III A four-valve A.C. superheterodyne receiver	137
IV A five-valve receiving circuit for car radio	143
V A seven-valve quality A.C. mains receiver with Rimlock valves	152
VI A fifteen-valve quality receiver for A.C. mains	160

	Page
The Rimlock U-series of broadcast valves	170
UAF 42 (UAF 41) Variable-mu diode-pentode	171
UB 41 Double diode	189
UBC 41 Double diode-triode	191
UCH 41 Triode-hexode frequency changer	196
UCH 42 Triode-hexode frequency changer	211
UF 41 Variable-mu R.F. pentode	228
UL 41 9 W output pentode	235
UY 41 Half-wave rectifying valve	245
UY 42 Half-wave rectifying valve	249
U 30 Barretter	252
VII A five-valve receiver for A.C./D.C. mains	254
VIII A four-valve A.C./D.C. superheterodyne receiver	259
XI An eight-valve A.C./D.C. superheterodyne receiver with push-pull output stage	264
The Rimlock D-range of broadcast valves	270
DAF 40 Diode-R.F. pentode battery valve	272
DAF 41 Diode-A.F. pentode battery valve	279
DK 40 Battery octode	282
DL 41 Battery output pentode	298
X A battery receiver with 4 Rimlock valves	313
Miscellaneous Rimlock type amplifying valves	319
ECC 40 Double triode	320
EF 40 A.F. pentode	334
EF 42 R.F. pentode with high mutual conductance	340
UF 42 R.F. pentode with high mutual conductance	345
XI A 10-watt amplifier with two Rimlock valves EL 41 in Class AB push-pull	348
“Miniwatt” miniature valves	351
DAF 91 Diode-A.F. pentode battery valve	353
DF 91 Battery-type R.F. pentode	357
DK 91 Battery-operated frequency changer	363
DL 92 Battery output pentode	374
XII A battery receiver employing “Miniwatt” miniature valves	385
XIII A four-valve battery receiver	390

	Page
“Miniwatt” Noval valves	396
EBF 80 Double diode-variable-mu pentode	397
UBF 80 Double diode-variable-mu pentode	405
EQ 80 Enneode	413
XIV A four-valve A.C. superheterodyne receiver with reflex circuit	423
XV A five-valve A.C. mains superheterodyne receiver	427
XVI A four-valve A.C./D.C. superheterodyne receiver	430
XVII A nine-valve A.M./F.M. receiver for A.C. mains	432
Latest Philips Measuring and Auxiliary Equipment	443
Cathode-ray oscilloscope GM 5653	444
Signal tracer GM 7628	447
RC-oscillator GM 2315	450
D.C. power supply unit with stabilized output voltage, type GM 4560/01	453
Modulated R.F. oscillator GM 2883	456
Universal measuring apparatus GM 4257.	459
R.F. service oscillator GM 2884	462
A.F. generator GM 2307	465
Electronic volt-chm-mA meter GM 7635	468
Cathode-ray oscilloscope GM 5655	471
Calibrating oscillator GM 2885	474
“Cartomatic” III valve tester GM 7633	477
Electronic voltmeter GM 6005	479
Universal bridge GM 4144	482
Diode-voltmeter GM 6004	485

Explanations relating to the technical data of Philips receiving and amplifying valves

Introduction

Technical data relating to receiving and amplifying valves fall under three headings :

- a. Typical characteristics
- b. Operating characteristics
- c. Limiting values

Typical characteristics cover the properties of the valve alone, with no electrical components connected to the electrodes. They include the mutual conductance, the internal resistance, the I_a/V_g and I_a/V_a characteristics, etc.

Under *operating characteristics*, the particular applications with appropriate circuits, working conditions and properties are given. Although it is generally advisable to adhere as closely as possible to the published data, deviations are permissible provided that no value is allowed to exceed the maximum specified for the valve in question under the heading *limiting values*.

Limiting values are the maximum permissible values for the voltages, currents, loads, etc. to be applied to the valve. Failure to observe these limits will undermine the quality and effective life of the valve; this subject is dealt with more fully in a subsequent paragraph.

I. General observations

- a. The data given for any one valve should be regarded as applicable to the average valve, representative of the type in question.
- b. Data relating to a valve used for a specific purpose are usually based on the anode current; this means that the grid bias should be adjusted to secure the anode current specified, without input signal, the grid bias being as a rule only approximate.
- c. The various electrode potentials of a valve are usually given with respect to a certain basic point, namely the cathode of indirectly heated valves, or the negative side of the filament of directly heated valves.
- d. In all circumstances, a D.C. conductor must be provided between each of the electrodes and the cathode of an electronic valve. Generally speaking, the resistance in an electrode circuit should not be higher than is necessary to ensure satisfactory performance of the valve. If the valve has a suppressor grid with a separate external contact, this grid should, unless it is used for a special purpose, be connected direct to the cathode.
- e. The output power W_o of an output valve is the power the valve is capable to deliver; owing to losses in the output transformer, amongst other things, the effective power is usually lower.
- f. As a rule, good air circulation is essential to avoid overheating of valves, and this is particularly true in the case of output and rectifying valves. For the same reason, other valves and components radiating heat should be kept sufficiently far apart.

II. Limiting values

IIA. General observations

Among the technical data of the electronic valves, a section headed "Limiting values" will be found. None of the electrical values listed under this heading should be exceeded when the valve, an average specimen of the type in question, is used in a circuit in which:

- a. the components are of nominal value,*
- b. the voltages are of nominal value,*
- c. there is no input signal.¹⁾*

Since in actual practice these conditions are not usually fulfilled, it is impossible always to remain within the specified limits. For normal variations in components and voltages, however, the valves possess enough reserve to ensure that their properties or life will not be affected. To clarify the phrase "normal variations", the following definition has been accepted: *Provided that, when an average valve is used in the circuit conforming to a, b and c above, none of the limiting values is exceeded, it is permissible:*

- 1. to use any valve of the type in question in that circuit;*
- 2. to allow such variations in the voltages as will correspond to a mains voltage fluctuation not exceeding $\pm 10\%$ (the voltage of an H.T. battery may drop to two-thirds of its nominal value; for L.T. batteries see para. IID);*
- 3. to allow such tolerances on the components, and apply such input signals as are specified in para's IIB and IIC.*

In car-radio sets and other vibrator-driven receivers operating on a 6 V (or 12 V) battery, allowances must be made for the pronounced voltage fluctuations liable to occur under normal working conditions: with this in view, the valve voltages in such sets are adjusted for a battery voltage of 7 (or 14 V); the filament voltage being then also 7 V. It is then permissible for the battery voltage to vary between 5.5 and 8 V (or between 11 and 16 V) - (see also para's IIB and IIC).

If variations in voltages or components greater than would be permissible according to the foregoing are anticipated, the working point of the valve must be reduced accordingly, although it is not permissible to raise the working point when variations encountered are below the limits set, seeing that the valve reserve is not usually sufficient to permit of continuous operation on values higher than the specified maxima. Nor is it permissible to allow variations in one voltage or component in excess of the maximum permissible limit when the variations in other voltages or components do not reach this limit.

IIB. Limiting values for anode and screen grid dissipations (W_a , W_{g2})

Anode and screen grid dissipations in an output valve may exceed the limit by max. 15% as a result of variations in the values of the components, or owing to the rise in voltage when the A.G.C. comes into operation.

¹⁾ For class B push-pull circuits this should read: *where the input signal is such that the anode dissipation reaches its maximum.*

In mains receivers, the different mains voltages are usually divided into a number of groups, covered by a tapping plate. Deviations arising from the fact that the nominal voltage in any one such range differs from the average voltage, fall within the above-mentioned 15%.

It is usual to include in the limiting values for output valves the maximum screen grid dissipation in the absence of an input signal (W_{g2} at $V_i=0$); this value should not be regarded as the maximum permissible dissipation, as it is given merely to assist in determining the working point of the valve: if this value is not exceeded in the absence of an input signal, it is unlikely that the maximum permissible dissipation will be exceeded when the signal is applied.

The limiting value for the screen grid dissipation in an output valve delivering maximum output power (W_{g2} at $W_0=\text{max.}$) is to be regarded as a limit which may be approached during brief periods only, under normal working conditions. Therefore, if the valve is required to deliver its maximum output continually, e.g. for measuring purposes, a lower working point must be employed.

To avoid excessive anode dissipation, the anode should be loaded continuously; this means that the anode circuit should never be interrupted, or the loud-speaker disconnected unless replaced by an equivalent resistor.

IIC. Limiting values for the positive voltages (V_a , V_{g2} , etc.)

The positive voltages in a circuit may exceed the limiting values, as a result of the causes enumerated in para. IIB, provided that the anode and screen grid dissipations of the output valve(s) remain within the limits defined in the same paragraph.

When switching on, and also owing to the subsequent effects of the A.G.C. coming into operation, the positive voltages may increase to the limiting values applicable when no current flows to the electrode in question (V_{a_0} , V_{g2_0} , etc.). If both alternating and direct voltages are applied to an anode simultaneously, the peak value may also approach this limit, provided that the current at that moment approximates to zero.

IID. Limiting values for heater voltages and currents (V_f , I_f)

Electronic valves may be divided into three classes, according to the filament or heater supply.

- a. *Valves for parallel feed* : Valves of which the filaments or heaters may be connected in parallel with a voltage source (transformer, battery or accumulator). The technical data of valves in this category are based on the filament or heater voltage as specified, whereas the current is only approximate.
- b. *Valves for series feed* : The filaments or heaters of these valves are connected in series with the voltage source (mains or battery). The technical data are applicable for the filament or heater current specified, the voltage being regarded as approximate.
- c. *Valves for parallel or series feed* : In this case the technical data are based on both the voltage and the current.

Apart from the condition that mains voltage fluctuations should not exceed 10% of the nominal value, the following has been laid down for the various types of valves :

1. Generally speaking, the filament or heater voltage of valves fed in parallel from a transformer should not vary by more than 5% of the nominal value as a result of tolerances on the transformer.

The mains voltage is usually divided into a number of ranges by means of tappings on the primary of the transformer. To prevent over- or under-heating, the highest and lowest nominal values in any such range should not differ by more than 5% from the average voltage in the range in question.

2. When indirectly heated valves are operated on a 6.3 (or 12.6) volt battery (car radios and other vibrator-driven sets), the battery voltage should never be allowed to drop below 5.5 (or 11) volts, or to exceed 8 (or 16) volts (see also para. IIA).
3. When a fixed series resistor is employed for series-fed valves, the heater or filament current should not vary by more than 3% of the nominal value as a result of tolerances on the value of the resistor, or in consequence of the nominal mains voltage failing to correspond to the average voltage within the range to which the set is adjusted. If a barretter is used instead of a fixed resistor, a tolerance in the heater or filament current of max. 5% is permissible.

Fig. 1 shows the voltage ranges which can be accommodated on the tapping plate when a fixed resistor is employed: $\Delta R/R$ represents the tolerance on the resistors involved, V_f the total heater voltage, and V_m the average voltage within a given range. The limits of a voltage range are determined by $V_m (1 \pm \Delta V_m/V_m)$.

4. The set of valves UCH 41 (or UCH 42, or UCH 21), $2 \times$ UAF 42, UL 41 and UY 41 can be fed in series from mains supplying a nominal voltage of 110—127 V, without employing any series resistor.

The UCH 41 (or UCH 42), UAF 42, UL 41 and UY 41 can be operated on such mains in conjunction with a 130 ohm resistor, whilst the UCH 21, UAF 42, UL 41 and UY 41 require a 70 ohm resistor (tolerances on these resistors not to exceed $\pm 5\%$).

At higher mains voltages it should be borne in mind that the minimum heater current of the Rimlock U-range and the UCH 21 is 92.5 mA, and the maximum heater current 110 mA; these limits must be maintained, even when mains voltage fluctuations are

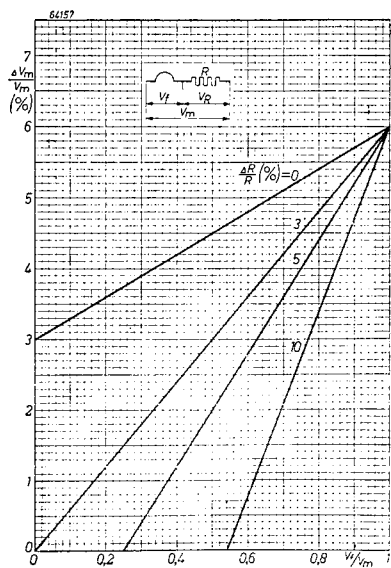

Fig. 1. For explanation see text.

likely to occur. In this connection the barretter U 30 described in this book is important.

For other valves, used with a series heater chain, reference should be made to para. 3.

5. If the filaments of battery valves are operated in series, a resistor must be connected across each filament to divert the cathode currents of the other valves. If the filament has a central tapping, a similar resistor should be connected across the negative section of the filament, to divert the cathode current of the other half of the filament.
6. Battery valves of which the nominal filament voltage is 1.4 (or 2.8) V should be operated from batteries supplying a voltage of the same nominal value, the maximum being 1.5 (or 3.0) V, and the minimum 1.1 (or 2.2) V. If the filaments of such valves are operated in series from D.C. mains, or, by using a rectifier, from A.C. mains, the filament voltages should be reduced to 1.3 (or 2.6) V.
7. When the switch of a set in which the heaters are fed in series, is closed, the differences between the warming-up times of the various cathodes may cause the heater voltages of some of the valves to rise above the nominal value. In an average valve this rise should not exceed 50% of the nominal voltage. If greater fluctuations occur, a current-limiting resistor (varite) must be used to reduce the variation, or, as an alternative, a relay connected across the heaters concerned can be made to short-circuit them when the set is first switched on.

Note : In broadcast receivers employing standard series of valves, the rise in heater voltage is always well within the 50% limit mentioned, and no precautions are necessary.

III. Limiting values for the voltage between heater and cathode (V_{fk})

The limits specified under this heading are applicable to direct voltage, to the r.m.s. value of an alternating voltage, or to the sum of both and relate to the voltage between the cathode and that end of the heater at which the voltage is the higher. For direct voltage it is usually best if the cathode is made positive with respect to the heater. Furthermore, it is generally advisable to prevent voltages at signal frequency from occurring between the heater and the cathode; owing to lack of uniformity in the insulation of the cathode, such voltages may lead to crackle or interfering modulation. If a limiting value of $V_{fk}=0$ V is specified, the cathode should be connected to one end of the heater.

III. Limiting values for the grid and diode starting current

(V_g at $I_g=+0.3 \mu\text{A}$ and V_d at $I_d=+0.3 \mu\text{A}$)

In contrast with the other limiting values, these are not limits in the sense that they must never be exceeded, but represent the limit below which the current flowing to the particular grid (or diode-anode) will remain below $0.3 \mu\text{A}$. This limit is determined when the valve is used in a normal circuit, operating on normal voltages.

II G. Limiting values for the external resistance between control grid and cathode (R_g , R_{g1})

In the case of output valves, two limiting values are often specified for this resistance, one relating to fixed grid bias and the other to automatic bias (bias derived from a cathode resistor). If semi-automatic grid bias is employed (bias obtained by means of a resistor in the common negative line of the valves), the maximum permissible value of the grid leak can be determined with the aid of the formula :

$$R_{g1} = \max. \frac{\text{cathode current of output valve}}{\text{total current flowing through the common neg. line}} \times R_{g1}'$$

where R_{g1}' is the maximum permissible grid leak when automatic bias is employed.

III H. Limiting values for the protecting resistance for rectifying valves (R_t)

In order to avoid sputtering (momentary flash-over between anode and cathode) in a rectifying valve, a certain D.C. resistance should be included in each anode circuit; the minimum value for this resistance is always specified. If a transformer is connected between the mains and the rectifier, the D.C. resistance of this transformer will provide all, or part of, the resistance required. In this case the following formula applies :

$$R_t = R_s + n^2 R_p + R_1, \text{ where, for half-wave rectifiers :}$$

- R_t = the necessary protecting resistance,
- R_s = the D.C. resistance of the secondary winding,
- n = the transformation ratio,
- R_p = the D.C. resistance of the primary,
- R_1 = the extra resistance required.

For full-wave rectifiers, the symbols have the following meanings :

- R_t = the necessary protecting resistance, per anode,
- R_s = the D.C. resistance of half the secondary winding,
- n = the transformation ratio between the primary and half the secondary,
- R_p = the D.C. resistance of the primary,
- R_1 = the extra resistance required in each anode circuit.

If the rectifier is followed by a reservoir capacitor, the fact that ripple current as well as direct current will flow through the protective resistor should be taken into account in determining the wattage of this resistor. Accordingly, it is usual to take a wattage about three times as high as would be necessary for direct current only.

III K. Limiting values for the cathode current of pulse-operated valves

In the pulse-operation of receiving or amplifying valves, cathode current pulses of up to 25 times the maximum permissible average cathode current, as

stipulated under the heading "Limiting values", are usually permissible. The duration of the pulse, however, should not exceed 10% of the repetition period, and should not in any case exceed 50 μ sec. Any departure from this condition will always be specified in the data of the valve concerned.

III. Mounting of electronic valves

Unless otherwise indicated, a valve may be mounted in any position, provided that the following conditions are observed :

- a. Valves of pinch construction must not be so mounted that the base is on a higher level than the top of the bulb.
- b. Should a directly heated rectifying valve be mounted in any other position than the vertical, the filament(s) must lie in a vertical plane.

If necessary, precautions must be taken to ensure that valves will not fall out of their holders as a result of jolting or vibration, either in transit or in use. Any cans fitted round the valves for this purpose must not interfere with the essential air circulation for cooling the valve (see Chapter I, para. f).

IV. Microphony in A.F. amplifying valves

In the data for A.F. amplifying valves minimum values are given for the input voltage, which can be allowed to result in a given power output from the amplifier, without the need for special precautions to prevent microphony. The significance of this will be seen from the following explanation.

Microphony may be caused in various ways, e.g. by vibration of the components of the valve. Such vibrations may be of mechanical origin, as for instance vibration of the speaker cone, transmitted to the electrode system either mechanically through the chassis, valveholder and valve pins, or acoustically (sound waves striking the bulb). In an A.F. valve this might affect the anode current, with the result that sound is emitted from the speaker in the form of a continuous or gradually diminishing note, or as crackle or background noise, even when no A.F. signal is applied to the grid of the valve.

The most important factors affecting microphony are the amplification of the valve concerned and that of the valve or valves next in sequence, the acoustic efficiency of the speaker, etc. Other factors, however, such as cabinet resonance, may also have an effect.

In order to illustrate the conditions under which microphony is not likely to occur, the operating characteristics of the A.F. amplifying valves state the permissible strength of the input signal, applicable to the entire frequency range, when the output valve delivers 50 mW to the speaker, it being assumed that the speaker has an acoustic efficiency of 5% and that the valve and the speaker are at least 10 cm apart, but in the same cabinet. It is emphasized, however, that this value of the input signal is given for general information only, since microphony might occur at lower signal strengths under adverse conditions, or it could be due to causes other than inter-action between speaker and valve, e.g. when the chassis is subjected to mechanical vibration or jolts.

In amplifiers where, as a rule, the loudspeaker is not mounted in the vicinity of the valves, microphony does not usually occur so readily. The general rule applicable here is that no special measures need be taken to avoid microphony if the sound intensity with respect to the valve, at the input signal strength specified, corresponds to that described above. If it is desired to use a greater amplification than would be in keeping with the restrictions mentioned, special measures will generally have to be taken to avoid microphony, such as using an antimicrophonic valveholder, or the fitting of rubber grommets between valveholder and chassis (necessitating flexible leads), or an acoustic shield round the valve.

List of symbols

1. Symbols for electrodes and base connections

Anode	<i>a</i>
Anode of detector diode	<i>d</i>
Filament, heater or resistance wire	<i>f</i>
Central tapping of filament or heater	<i>f_c</i>
Grid	<i>g</i>
Terminals not for external connection	<i>i.c.</i>
Cathode	<i>k</i>
External conductive coating	<i>m</i>
Internal screening	<i>s</i>

Remarks

- a. Where there are a number of identical electrodes in a valve, they are distinguished by the use of accented letters; the anodes of a full-wave rectifier, for example, are indicated thus: *a* and *a'*.
- b. Electrodes of the same kind in any one electrode system are differentiated by the use of subscripts, the electrode nearest the cathode being numbered 1. The grids of a pentode, for instance, are indicated thus: *g₁*, *g₂*, *g₃*. Figures are also used to qualify two or more diodes contained in a single envelope; that diode which is the most suitable for detection of the signal is always numbered 2 (*d₂*).
- c. Electrodes of the same kind in different electrode systems contained in the same envelope are distinguished by means of the following subscripts:

for a triode	<i>T</i>
for a tetrode	<i>Q</i>
for a pentode	<i>P</i>
for a hexode, or heptode	<i>H</i>

2. Symbols denoting voltage

Voltage between anode and cathode	V_a
Ditto., with no anode current flowing	V_{a_s}

Peak inverse anode voltage	$V_{a\text{inv}\rho}$
Supply voltage	V_b
Voltage range of a barretter	V_{contr}
Voltage between anode and cathode of a detector diode	V_d
R.M.S. value of a voltage	V_{RMS} or V_{eff}
Filament or heater voltage	V_f
Voltage between heater and cathode	V_{fk}
Voltage between grid and cathode	V_g
Ditto., with no current flowing to the grid concerned	V_{g_c}
Alternating input voltage	V_i
Direct voltage delivered by a rectifier, or alternating output voltage	V_o
Oscillator voltage	V_{osc}
Peak voltage	V_p
Voltage for A.G.C.	V_R
Output voltage of a transformer (not under load)	V_{tr}

3. **Symbols denoting current.** Positive electric current flows in the opposite direction to the electron stream.

Anode current	I_a
Current of a detector diode	I_d
R.M.S. value of a current	I_{RMS} or I_{eff}
Filament or heater current	I_f
Grid current	I_g
Cathode current	I_k
Direct current delivered by a rectifying valve	I_o
Peak value of a current	I_p
Stabilized current of a barretter	I_{reg}

4. **Symbols denoting power**

Anode dissipation	W_a
Grid dissipation	W_g
Input power	W_i
Output power	W_o

5. **Symbols denoting capacitance** (measured with cold valve)

Capacitance between anode and all other electrodes and screens, excluding the control grid	C_u
Capacitance between anode and grid (all other electrodes and screens earthed)	C_{ug}
Capacitance between anode and cathode (all other electrodes and screens, not connected to the cathode, earthed)	C_{uk}
Input capacitance of smoothing filter	C_{jil}
Capacitance between cathode and heater	C_{fk}
Capacitance between grid and all other electrodes and screens, excluding the anode	C_g

Capacitance between two grids (all other electrodes and screens earthed)	C_{g1g2}
Capacitance between grid and cathode (all other electrodes not connected to the cathode, earthed)	C_{gk}
Capacitance between cathode and all other electrodes	C_k

6. Symbols denoting resistance

External resistance in anode circuit, or optimum load	R_a
Optimum load in push-pull circuit (anode to anode)	R_{aa}
R.F. damping resistance of a diode circuit	R_d
Equivalent noise resistance	R_{eq}
External resistance between cathode and heater	R_{fk}
External resistance in grid circuit	R_g
Internal resistance	R_i
Resistance in cathode circuit	R_k
Protective resistance in each anode circuit of a rectifying valve	R_t

7. Miscellaneous symbols

Distortion factor	d
Noise factor	F
Frequency	f
Maximum or limiting frequency	f_{max}
Power amplification	G
Voltage gain	g
Cross-modulation factor	K
Hum-modulation factor	m_b
Transformation ratio	n
Mutual conductance	S
Conversion conductance	S_c
Effective slope of an oscillator	S_{eff}
Slope of grid 1 with respect to grid 2	S_{g2g1}
Slope of oscillator triode with $V_g=0$ V and $V_{osc}=0$ V	S_o
Phase angle	φ
Efficiency	η
Wavelength	λ
Resonance wavelength	λ_{res}
Amplification factor	μ
Amplification factor, grid 2 with respect to grid 1	μ_{g2g1}
a less than b	$a < b$
a greater than b	$a > b$

Introduction

Over recent years Philips have introduced a range of valves under the trade-mark of "Miniwatt" for radio receivers and other purposes, and the more important types in this range have already been described in volumes II and III; the latest additions are dealt with in this volume.

The entire evolution of the radio valve is reflected, as it were, in this range of valves, the interesting point about the development being that it has followed three different trends. First there was the evolution of the electrode system. Whereas all the functions in earlier radio receivers were fulfilled by triodes, it was not long before most of these functions were taken over by valves of more intricate design. In consequence, most valves today are made with three or more grids. The advantages of multi-grid valves in their various fields of application are fully discussed in the first volume of this series of books, so that there is no need to dwell on the subject here.

The second direction in which development took place was perhaps not quite so obvious, but it has nevertheless contributed considerably to the general progress of radio technology and is mainly responsible for the high quality and sensitivity of present-day receivers. We refer to the development of the components from which the electrode system is built up.

During the last decades, extensive scientific research has furnished us with a great deal more information regarding such factors as thermal and secondary emission, valve noise, microphony, distortion, and so on. Electronics and material research, too, have made enormous strides, added to which the accuracy and reliability of tools and machines have both reached much higher levels. All these factors have made possible a better choice of materials, and improved design and disposition of the components, thus continually bringing to the fore the more useful properties of the valves, whilst suppressing the less advantageous characteristics.

Quite apart from the ingenious principle upon which it is based, a modern radio valve may therefore be regarded as one of the greatest accomplishments in science and technology.

One aspect of the development under discussion is of special interest ; originally, in endeavouring to improve the properties of the radio valve, the spacing of the various electrodes was continually being reduced. At one particular phase in the development, however, some of the spacing, notably that between the cathode and the control grid, did not appear to be undergoing any further changes. The reason for this will be obvious : any further reduction would undoubtedly have yielded still greater improvements, but these would not have outweighed the disadvantages of the more critical construction and consequent increased risk of a short circuit or other defects. It will thus be seen that the more critical spacing within the electrode system in a modern radio valve very nearly corresponds to that of older types, in spite of the fact that the external dimensions have been considerably reduced. A typical example of this is given in Figs. 2 and 3. Fig. 2 shows that the reduction in the overall height of the valve is obtained entirely by eliminating ineffective space, whilst in Fig. 3 we see that, although the diameters of both envelope and electrode system have been reduced, the

distance from the cathode to the control grid is only slightly smaller than before.

At the same time, it should be noted that in some valves intended for special purposes these critical dimensions have actually been reduced, although this was made possible only by taking special precautions to maintain the reliability of the valve.

The third factor in the evolution was concerned with the envelope of the valve; since this subject is reviewed fully in volume I, a brief summary will here suffice.

Originally, valves of all types were designed on the principle of the incandescent lamp, employing the so-called glass "pinch" through which the leading-in wires passed to the various electrodes, the other ends being soldered to pins or contacts on a "Philit" base attached to the envelope.

For a long time the "pinch" method of construction gave every satisfaction, but eventually it was found to have certain disadvantages, mainly owing to the demand for better quality reception and to the ever-increasing importance of short-wave broadcasting. Some of the difficulties were overcome

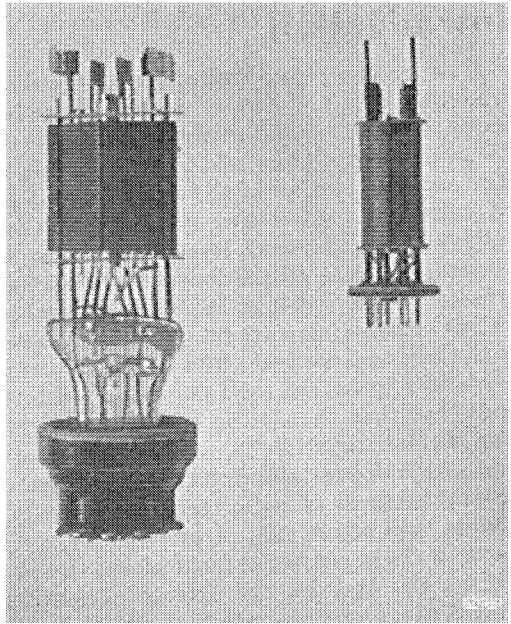

Fig. 2. Left: the electrode system of an old type of output pentode (EL 3N). Right: the electrode system of a Rimlock output pentode (EL 41). The maximum anode dissipation of both valves is 9 W, the slope being about 10 mA/V.

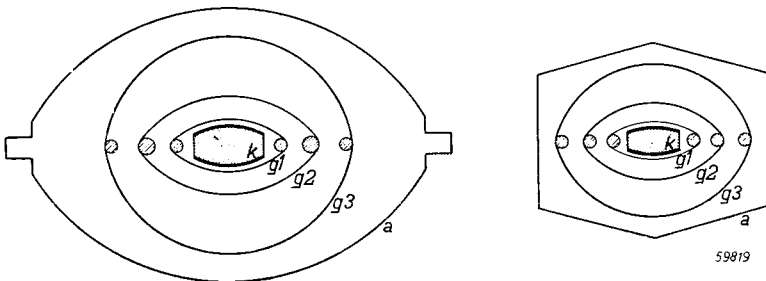

Fig. 3. Cross-sections of the two electrode systems shown in Fig. 2. The distance from cathode to control grid is roughly the same in both diagrams.

by altering the design, but no definite improvement was achieved until the "pinch" was replaced by a flat, glass base. With this method of construction, a number of pins sealed in the base, so as to be vacuum-tight, serve as the electrode connections, ensuring a robust, compact assemblage. The "Philite" base previously used was thus rendered superfluous.

The excellent properties of valves designed on this principle are fully described in Volumes I and III, and can be summarized as follows :

1. Owing to the reduced length of the connections to the various electrodes, the capacitances, self-inductances and electrical losses in these connections are very low, whilst undesirable coupling between these connections is also considerably reduced. This is the reason for the very satisfactory performance of these valves in the short-wave bands.
2. As no "Philite" base is used, the capacitances of the valve are only to a small degree dependent on the temperature; hence, tuned circuits used with the new type of valve suffer only slight detuning while the valves are warming up. This is particularly important in oscillator circuits, since the troublesome frequency drift that occurs when the valve is warming up, is now much less pronounced.
3. Since the electrodes are welded to the contact pins, there are no soldered joints and there is no risk of interference due to faulty soldered connections.
4. In all-glass valves with flat bases it is a simple matter to provide screens, so that all the electrode connections may be taken through one end of the valve. Even the grid-to-anode capacitance is thus reduced to the low value prevailing in earlier types of valve with top caps. The wiring of the chassis can now be arranged in a simple, logical manner, and the awkward arrangement of the lead to the top cap is eliminated.
5. Owing to the absence of the "pinch" and "Philite" base, the overall dimensions of the valve are now very much smaller, without necessitating any reduction in the critical dimensions of the electrode system itself. The smaller dimensions of the valve in no way affect the electrical properties of the valve, nor have they rendered the valve more sensitive to interference.

Apart from the Loctal valves described in Volume III, Philips manufacture three different types of valves with flat glass bases, namely the Rimlock, miniature and Noval valves. All these types are dealt with in this volume.

"Miniwatt" Rimlock valves

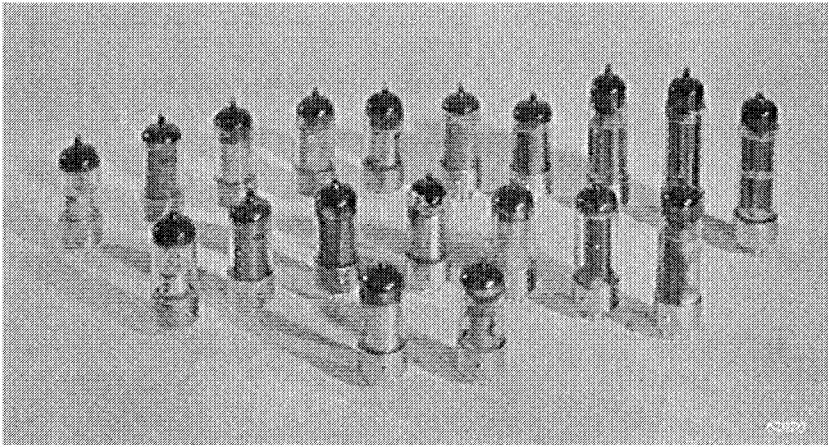

Fig. 4. Rimlock valves.

As previously mentioned, the new Rimlock valves are all-glass with flat bases and therefore have all the advantages that this method of construction offers, one of these being that the valves can be made with smaller dimensions without any adverse effects on the electrical properties.

Smaller radio valves have long been the aim of the designer, as manifested by the fact that the size of the "Miniwatt" range of valves has year by year been gradually reduced (the "Gold" range, the "Red" range and the "Loctal" range). One of the reasons for this tendency has been the ever-increasing demand for smaller receivers in all parts of the globe; also smaller valves have come to be regarded as essential in other fields of application, such as in portable receivers, measuring apparatus and for numerous industrial purposes. Another fact that must not be overlooked is that the performance of a valve on short waves is generally improved by reduction in the size of the valve. Prior to the war the use of short waves was restricted almost exclusively to the wavelengths above 10 metres, but a radical change has since taken place; suffice it to mention only the development of F.M. and television receivers, both of which operate mainly on the shorter wavelengths.

Taken all round, there have been ample reasons for continued research into every possibility of making still smaller valves, and when Philips have been able to achieve this by applying new ideas they have promptly acted upon them. Moreover, when the means were discovered for making receiving valves in the smaller types as well, which were not only quite as good as the larger types from the point of view of electrical properties but in many respects even better, a whole range of valves of the new design was introduced. This was the new "Rimlock" range of radio valves, already described in volume I.

Features of the Rimlock valves

The advantages of the Rimlock valve may be summarized as follows:

1. All-glass construction with flat base, ensuring excellent high-frequency characteristics.
2. Small dimensions.
3. Simple design and hence reliability in operation.
4. It is almost impossible to insert the valve incorrectly in the valveholder.
5. The valve is locked in position and cannot come loose in transit.
6. The valve has eight contact pins, enabling a frequency changer of high quality on the triode-hexode principle to be included in the range.
7. Low power consumption, this being particularly important in the case of battery valves.
8. A wide range of types ensures that the most suitable set of valves is available for any kind of receiver, or to meet any given conditions.

Dimensions of the Rimlock valves

In the past, any further reduction in the size of all-glass valves with flat base was restricted by the method of manufacture employed at the time, but since the introduction of a new sealing-in process, these limitations no longer exist, the size of the valve being limited only by the electrical properties. Naturally, extensive research then became essential to determine those factors which would impose new restrictions. As expected, the temperature of the electrode system under working conditions proved to be a deciding factor, which meant that the output valves in the broadcast series, with their high anode dissipation, called for special consideration. As these valves were designed to give a high mutual conductance (approx. 10 mA/V), the heater consumption was also on the high side (approx. 4.5 W). A reduction in the slope would have permitted a reduction in size, but as this would also mean a corresponding drop in sensitivity, this was not resorted to.

It was also found that the temperature of the glass envelope might adversely affect the performance of the valve, if allowed to become too high. The dielectric properties of an insulating material usually deteriorate at high temperatures; thus, for instance, the dielectric losses in the glass surrounding the pins are increased and the chance of electrolysis becomes greater, whereby eventually the vacuum in the envelopes may be endangered. The foregoing remarks also apply to the valveholder; here over-heating results in increased losses and possible carbonization of the insulating material, in consequence of which leakage currents flow and even flash-over may occur between the contacts.

Accordingly, a minimum of 22 mm has been laid down for the diameter of Rimlock valves, but even this means a considerable saving in chassis space, seeing that the diameter of the Loctal valves is 32 mm.

Rimlock valves are also much shorter than their predecessors, but, as the different valves have not all exactly the same length, the actual dimensions are included in the descriptions of the individual valves.

These small Rimlock valves, including the output valves with their high mutual conductance, can be guaranteed to give a good performance even under adverse climatic conditions, such as those which prevail in the tropics. Actually, they possess sufficient reserve easily to discount all normal mains voltage fluctuations as well as the tolerances on resistors and other components. Further reference is made to this point in the section on output valves. Needless to say that, although it is not desirable to reduce the diameter of the output and certain other valves beyond 22 mm, this limit need not necessarily apply to all the remaining types. It would, in fact, be quite possible to reduce the size of most types without any difficulty, but they would then require special valveholders. In that case, in the manufacture of the valves, as well as in the development of receivers, a departure would have to be made from the principles of standardization, for which reason all Rimlock valves are made in the same diameter, viz. 22 mm.

Simplicity of construction

Generally speaking, the less complicated the electrode system of a radio valve, the more reliable its performance. The guiding principle in the development of Rimlock valves has therefore been that logical and consistent simplification of the system would result in stable and reliable performance, coupled with good electrical properties.

Self-locating and locking of Rimlock valves

The base of the Rimlock valve contains eight contact pins evenly spaced around the periphery of a circle 11.5 mm in diameter (Fig. 5). With this uniform spacing, some device that will preclude any possibility of the valve being inserted incorrectly in the valveholder is essential.

Loctal valves were therefore made with a central pilot secured to the bottom of the valve by means of a metal plate. Rimlock valves, however, have a pip on the rim of the base, which serves, firstly, to guide the valve into the holder, and, secondly, to lock it in position (hence the name "Rimlock").

To ensure that the pip

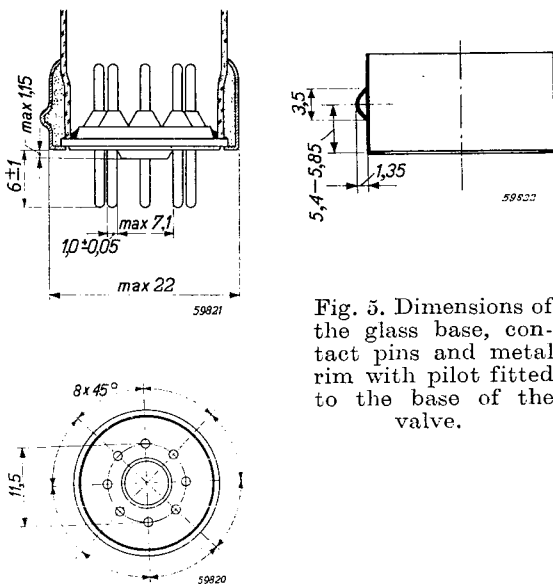

Fig. 5. Dimensions of the glass base, contact pins and metal rim with pilot fitted to the base of the valve.

will correctly guide the valve into the holder, the latter is made with a grooved sleeve. When inserted in the holder, the valve is rotated until the pip locates in the groove, after which it can be pressed home. The great advantage of this method of locating the valve in its holder is that only the sense of touch is involved in inserting the valve correctly, so that this can be done without difficulty when the holder is not directly visible. Once the valve, thus automatically located in the holder, is pressed home, the projection engages with a spring clip which then holds the valve in position. This arrangement ensures that the valve is always held securely in the holder during such time as the equipment is in transit.

The Rimlock valveholder (Fig. 6)

Generally speaking, the development of a new valve design cannot be regarded as having reached completion until a valveholder has been designed which is adapted to the mechanical and electrical properties of the valve,

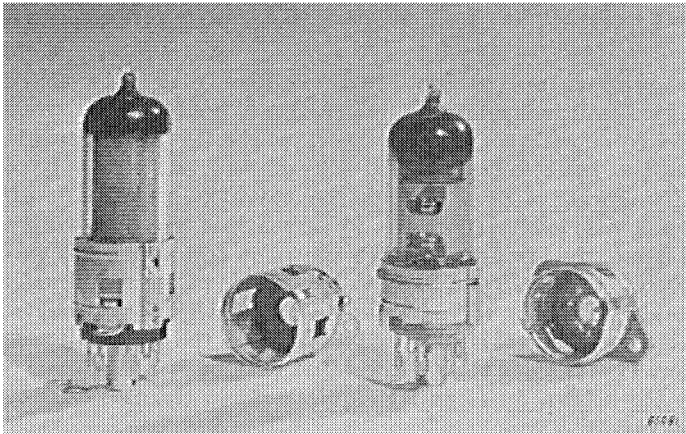

Fig. 6. Rimlock valveholders.

and in the combination of Rimlock valve and valveholder this is particularly apparent. As already explained, the mechanism here is such that the valve is automatically aligned in the holder and is then securely locked in position, so that there is no risk of its shaking loose in rough transit.

The many electrical advantages, especially for the shorter wavelengths, of the method of carrying the electrode connections out through the glass base by means of pins include the low capacitances between the contact pins and the shortness of the conductors between the electrodes and the external connections. These advantages are maintained in the new valveholder by using so-called "scraper springs" (Fig. 7). Since these springs are quite small, the capacitances between them are low, and, as they make contact with the pins immediately below the base of the valve, short con-

nections are ensured. Another advantage of these springs is that they scrape off all dust etc. from the pins when the valve is inserted, thus ensuring effective electrical contact between spring and pin.

These scraper springs are split longitudinally, as will be seen from the slightly

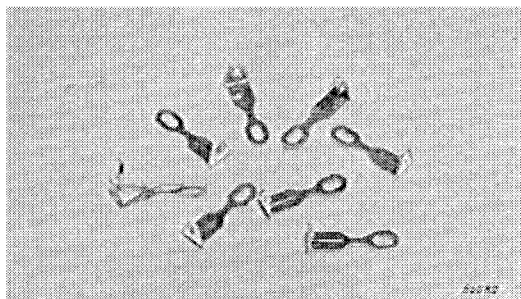

Fig. 7. A set of scraper springs: that on the extreme left is slightly twisted to show the slot.

twisted spring in Fig. 7. When the valve pin is pressed through the spring, the spring opens out slightly and so makes flexible, but firm, contact on both sides of the pin. The upper end of the spring is held between two plates of insulating material; the lower part, used as the solder tag, protrudes from the holder. Photographs and drawings of two different types of Rimlock valveholders are shown in Figs. 6, 8 and 9. In the one the springs are held by two "Philite" plates, in the other by plates of synthetic resin-bonded paper. Both holders are provided with a metal sleeve m with a groove l ; the valve can be pressed into the holder only when the pilot b has entered this groove. In one type of valveholder a flat spring is used to lock the valve in position (n in Fig. 8), in the other a wire spring (n in Fig. 9) serves this purpose; when the valve is pressed home, the spring slips over the pilot and holds the valve down. A metal bush (k in Figs. 8 and 9) on the underside of the valveholder extends up to the underside of the valve base and, when earthed, provides electrostatic screening between the valve pins, the wiring and the contact springs of the valveholder. This ensures that a low value of C_{ag1} is maintained when the valve is in the holder, an essential requirement in the case of R.F. and I.F. amplifying valves.

N.B. There are one or more tongues on the metal sleeve of the valveholder; it is important that these be *bent slightly inwards before the valve is inserted*, so that electrical contact will be established between the earthed metal sleeve of the valveholder and the metal ring round the base of the valve¹). Capacitances between the valve pins are thus kept as low as possible, and the leads themselves are at the same time provided with an external screen. Moreover, the transfer of heat from the metal ring round the valve is assisted by the metal sleeve on the valveholder, which ensures that the temperature of the valve is kept as low as possible. This is particularly important in the case of output and rectifying valves.

¹) Formerly, the pilot was part of a metal ring fitted round the base of the valve, but it is now made integral with the glass envelope. The metal sleeve on the valveholder must still be properly earthed, however.

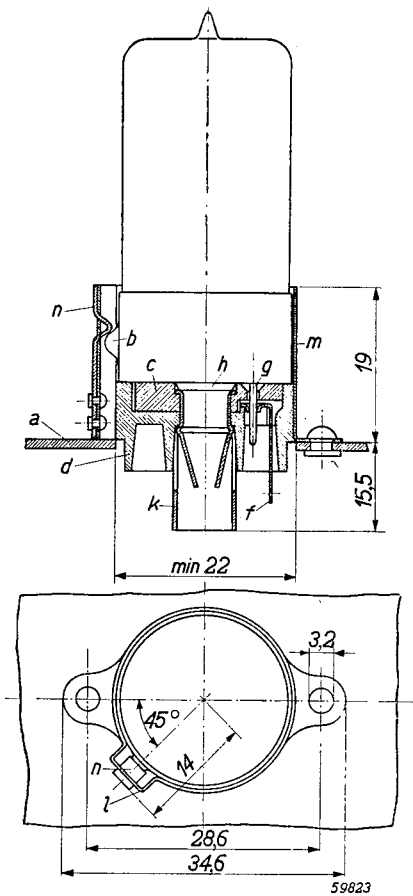

Fig. 8.
Valveholder for Rimlock valves,
with "Philite" insulation.

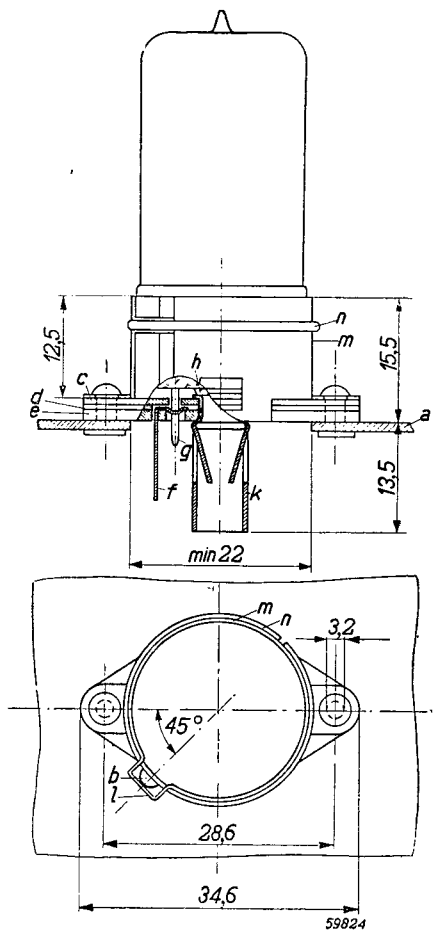

Fig. 9.
Valveholder for Rimlock valves,
with resin-bonded paper insulation.

Explanation of Figs. 8 and 9.

- a* = chassis
- b* = pilot
- c*
- d* } = insulating plates
- e* }
- f* = scraper spring
- g* = valve pin
- h* = depression in the glass base
- k* = screening bush between the connections
- l* = groove for pilot *b*
- m* = raised metal sleeve
- n* = locking spring

It is important that the valve *be inserted into the holder as far as possible*. The internal screening between the electrode connections of certain valves (see, for example, the description of the EF 41) is then almost continuous with the external screening, which consists of a metal bush (*k* in Figs. 8 and 9). In this way capacitances between the electrode connections are reduced to a minimum.

Classification of the Rimlock valves

The great significance of the Rimlock method of construction has already been sufficiently well demonstrated in the foregoing paragraphs ; it brings with it many advantages not only in valves for ordinary radio receivers, but also for other purposes, such as in F.M., ultra-short wave and television receivers. The Rimlock range, then, embraces not only a series of standard receiving valves, but also various types intended for special purposes, so that the following classification is possible :

- a. Valves for standard (A.M.) receivers
- b. Valves for F.M. receivers
- c. Valves for amplifiers
- d. Valves for television receivers

It should be noted that this classification does not place the valves in sharply defined categories; the valves in any one group may quite easily be just as important in other groups. Generally speaking, however, classification of the valves according to their main functions should present no difficulties. Apart from the above general classification, Rimlock valves can, with one or two exceptions, be divided into three groups according to their filament or heater supplies, viz :

1. E-type valves for A.C. operation, with a heater voltage of 6.3 V
2. U-type valves for A.C. or D.C. operation; heater current 100 mA
3. D-type valves for battery operation; filament voltage 1.4 V

The AZ 41, which is a rectifying valve for a filament voltage of 4 V, is one of the valves which cannot strictly be included in any of these groups, but since it is intended for use in the power section of sets employing E-type valves, it has been included in group 1.

Rimlock valves for radio receivers

It is stated above that the Rimlock range of valves includes not only valves for radio receivers, but also a number of types developed primarily for use in amplifiers, television receivers, etc. In many cases, of course, these valves can also be used for radio reception, where, owing to their special properties, they will often give excellent results. A list of the valves which fall in this category, together with particulars of their functions and characteristics, is given in this chapter. More detailed descriptions will be found in other sections of the book.

THE E-SERIES OF RIMLOCK VALVES

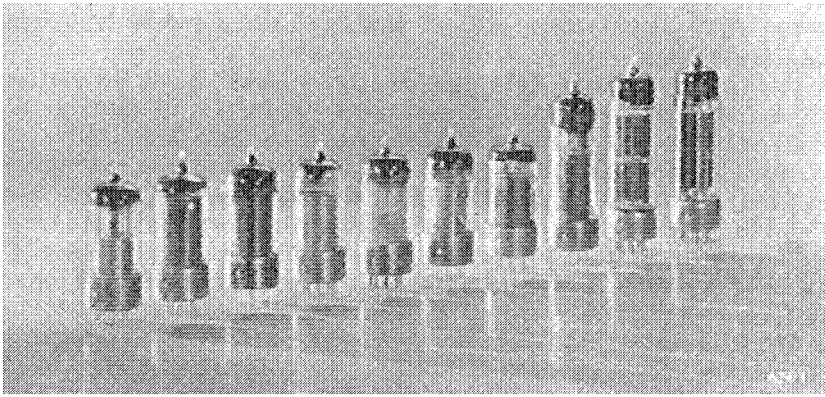

Fig. 10. Rimlock E-type valves for radio receivers.

The Rimlock E-type radio valves, with a heater voltage of 6.3 V, are intended for A.C. sets. Owing to their low filament consumption, however, most of these valves are also suitable for car-radio sets. Two special valves, the output valve EL 42 and the full-wave rectifying valve EZ 41, are also available for carradio sets. The last-mentioned valve can be used in conjunction with a single vibrator unit.

The entire series comprises the following valves :

AZ 41¹⁾: directly heated, full-wave rectifying valve for a rectified current of 70 mA max.

EAF 42 (EAF 41): diode variable- μ pentode used as a R.F., I.F. or A.F. amplifying valve. At the working point the slope is about 2 mA/V.

EB 41 : Double diode with separate cathodes.

EBC 41 : Double diode-triode with an amplification factor of 70.

ECC 40 : Double triode with separate systems ; amplification factor 32.

ECH 41 : Triode-hexode frequency changer with a conversion conductance of 500 μ A/V. This valve can also be used as an A.F. amplifier and phase inverter.

ECH 42 : As above, with a conversion conductance of 750 μ A/V. This valve can also be used as combined A.F. amplifier and phase inverter.

EF 40 : A.F. pentode with a straight characteristic and a slope of 1.85 mA/V.

EF 41 : Variable- μ pentode with a slope of 2.2 mA/V at the working point. This valve was designed primarily for R.F. and I.F. amplification.

EF 42 : R.F. pentode with straight characteristic and very high mutual conductance, viz. 9 mA/V.

EL 41 : Output pentode for a maximum permissible anode dissipation of 9 W, and a slope of 10 mA/V, capable of delivering 4.8 W output.

EL 42 : Output pentode for a maximum permissible anode dissipation of 6 W, intended especially for car-radio sets, for which reason the heater current has been kept as low as possible, viz. 200 mA.

EZ 40 : Indirectly heated full-wave rectifying valve capable of delivering a rectified current of max. 90 mA. The insulation between the heater and the cathode of this valve is so efficient that the heater can be fed from the same transformer winding as those of the other valves in the set.

EZ 41 : Indirectly heated full-wave rectifying valve capable of supplying a rectified current of max. 60 mA, intended especially for car-radio sets. The insulation between the heater and the cathode corresponds to that of the EZ 40.

CLASSIFICATION OF RIMLOCK E-TYPE RADIO VALVES ACCORDING TO FUNCTION

In order to provide a clear review of the Rimlock E-range as a whole, a brief classification of these valves according to their functions is given below.

R.F. amplifying valves

The EF 41 is the most suitable valve in the series for R.F. amplification. The slope is 2.2 mA/V, this being quite sufficient for most purposes, whilst the low anode-to-grid capacitance (<0.002 pF) is satisfactory from the point of view of parasitic oscillation. The equivalent noise resistance of this valve is only 6.5 k Ω .

Should an extra diode be required, the EAF 42 can be used as the R.F. amplifier.

Particulars relating to the use of the EF 42 as a R.F. amplifier will be found on page 340.

¹⁾ Although the filament voltage of this valve is 4 V, for which reason its type number commences with the letter A, it is included in the E-series because it was designed specifically to feed the valves in this series.

Frequency changers

The ECH 41 and ECH 42 are the frequency changers in the Rimlock E-series. The first is a variable- μ valve with a conversion conductance of $500 \mu\text{A/V}$ at the working point.

The ECH 42 is also a variable- μ triode-hexode, but the conversion conductance is higher ($750 \mu\text{A/V}$ at the working point) and the oscillation characteristics are better; it is therefore very suitable for sets in every price range.

I.F. amplifying valves

The EF 41 and the EAF 42 are intended for I.F. amplification. The slope of the EF 41 is 2.2 mA/V at the working point; that of the EAF 42 is slightly lower, viz. 2 mA/V at the working point, due to the fact that a part of the cathode serves the diode incorporated in this valve.

The anode-to-grid capacitance of both the EF 41 and the EAF 42 has been kept below 0.002 pF by fitting suitable internal screens. When determining the conditions for stability in an I.F. amplifier employing the EAF 42, the designer must bear in mind the fact that interaction occurs not only between anode and control grid, but also between the diode-anode and the control grid.

On the other hand, if measures are taken to reduce wiring capacitance to a minimum, the over-all coupling will be low enough to admit of full amplification, even if high-quality ($Q \approx 180 - 200$) coils are used, without any risk of parasitic oscillation. Further details on this subject will be found in the description of the EAF 42.

The EAF 42 is intended to replace the EAF 41; the electrical properties of the two valves are almost identical, but the third grid of the EAF 41 is internally connected to the cathode, whilst that of the EAF 42 is taken to a separate pin. This change was made because it was found that quite a sensitive receiver can be designed round the valves ECH 42 (or ECH 41), EAF 42, EL 41 and AZ 41, such that the EL 41 will deliver its full output power on relatively weak aerial signals. With the EAF 41 in a receiver of this kind, it is very difficult to provide delayed A.G.C. When undelayed A.G.C. is used, either the sensitivity is reduced or distortion sets in on strong signals. No such trouble is experienced when the EAF 42 is used instead, since then the separately connected third grid can be employed as a "delay diode" and the A.G.C. suitably delayed. This point is also mentioned in the description of the EAF 42.

In receivers employing the ECH 41 or ECH 42 as frequency changer with the EAF 42 or EF 41 for I.F. amplification, the screen grids of the two valves can be fed from the same potentiometer, thus saving one resistor and one decoupling capacitor. This method of combining the feeds has been taken into account in the design of the valve, i.e. the control characteristics are so matched that cross-modulation and modulation distortion in the combination are reduced to a minimum

Detector and A.F. amplifying valves

For A.F. amplification the Rimlock E-series includes the EAF 42, EBC 41 and EF 40.

The maximum A.F. amplification of the EAF 42 is at least 100, which, naturally, is much more than is usually required; in fact it is not even practicable to utilize the full gain without taking special precautions to prevent microphony. The actual limit below which no such precautions are necessary, is indicated in the detailed description of the valve.

When in practice the whole of the available gain of the EAF 42 is not used, a considerable reserve is made available, which can be usefully employed to provide negative feedback and so greatly reduce distortion. For example, with a feedback factor of 7, which reduces distortion by roughly the same factor, an amplification of 15 is still obtainable, this being quite sufficient for most purposes.

As an I.F. amplifying valve for use in conjunction with the A.F. amplifier EAF 42, a second EAF 42 is recommended. Two diodes will then be available, one for detection and the other for delayed A.G.C.

The amplification factor of the EBC 41 is 70, which also represents more gain than is usually required, and with this valve, too, feedback is generally used for the reduction of distortion. Since the EBC 41 contains two diodes, it can be used to advantage in conjunction with the I.F. amplifier EF 41. If, on the other hand, a three-diode circuit is required, the EAF 42 should be used as the I.F. amplifier.

The A.F. amplifying valve EF 40 is particularly recommended for high-quality receivers in which a low hum level is required. This valve has a bifilar heater, which ensures a very low hum level. From the point of view of microphony, too, the EF 40 is much better than either the EBC 41 or the EAF 42.

Output valves

The 9 W output pentode EL 41 is intended for use in standard types of receiver. It is capable of delivering a maximum of 4.8 W and, owing to its high slope (10 mA/V), is so sensitive that an input of only 5.1 V_{RMS} is required to drive the valve fully. This high slope is one of the reasons why a receiver designed round the combination of ECH 42 (or ECH 41), EAF 42, EL 41 and AZ 41 is sufficiently sensitive in spite of the few valves used. In larger sets the high sensitivity of the EL 41 enables negative feedback to be employed, with a consequent gain in quality.

Two EL 41 valves used in Class A push-pull (without grid current) will give an output of 9.4 W with 4.6% distortion. In this case the ECH 42 or the ECC 40 can be employed as a combined A.F. amplifier and phase inverter. The ECC 40 is a double triode of which each system has an amplification factor of 32 and a slope of 2.9 mA/V. It incorporates certain special features, including short, thick cathodes, to ensure that microphony will be suppressed as much as possible. In push-pull output stages in which the A.F. amplifier EF 40 is used, the use of the EBC 41 as phase inverter is recommended.

Besides the EL 41, there is the EL 42 output valve which, in view of its smaller size and low heater current (0.2 A), is particularly suitable for car radio. The EL 42 will deliver 2.5 W, with 10% distortion, the slope being 3.2 mA/V. In Class AB push-pull the maximum output power is 7 W, for a supply voltage of 250 V.

Rectifying valves

The rectifying valves AZ 41, EZ 40 and EZ 41 are available for use with the valves described in the preceding paragraphs. The AZ 41 is a directly heated fullwave rectifier with a 4 V filament, capable of giving a maximum output current of 70 mA.

The second of these, the EZ 40, is an indirectly heated full-wave rectifier capable of delivering a maximum of 90 mA. The heater voltage is 6.3 V and, since the maximum permissible (peak) voltage between heater and cathode is 500 V, the heater can be fed from the same transformer winding as those of the other valves. This eliminates the necessity for a separate heater winding with the high insulation usually required for this purpose. Another advantage of the EZ 40 is that it takes longer to warm up than other valves. This means that, since no voltage surge occurs across the smoothing filter in the power section when the receiver is switched on, the electrolytic capacitors used in the filter need not be rated for such a high voltage, and the cost of these components is thus reduced.

The EZ 41 is designed for car-radio sets supplied from a single vibrator unit. As in the case of the EZ 40, the heater is well insulated from the cathode, so that it can be fed from the same source, usually an accumulator, as the other valves in the set. This valve will deliver a maximum of 60 mA.

Tuning indicator

There is no tuning indicator in the Rimlock series. The reason for this is obvious: owing to the small diameter of this range of valves, the deflection would be difficult to gauge, and so would be almost ineffective. The tuning indicator EM 34 is therefore recommended; this tube is electrically identical with the EM 4¹⁾, but is fitted with the Octal base.

RECEIVERS EMPLOYING RIMLOCK E-TYPE VALVES

A few examples of suitable combinations of Rimlock E-type valves for receivers have already been suggested in the preceding paragraphs. The following is a summary of such combinations, which however by no means exhausts all the possibilities. Some of the arrangements suggested are described in detail in subsequent sections.

¹⁾ A complete description of the EM 4 will be found in Volume II of this series of books.

1. ECH 42 (or ECH 41), EAF 42, EL 41, AZ 41 (or EZ 40)

This is a receiver in the lowest price range; it is quite sensitive in spite of the few valves used. Delayed A.G.C. is made possible by using the EAF 42.

2. (EF 41), ECH 42 (or ECH 41), EAF 42, EAF 42, EL 41, AZ 41 (or EZ 40), EM 34

Since two diodes are available, the detection and A.G.C. circuits can be separated. By using the EAF 42 for A.F. amplification, sufficient gain is held in reserve to admit of ample A.F. feedback, and this greatly improves the quality of reproduction. If necessary, a R.F. amplification stage can be added by including the EF 41, thus ensuring a better signal-to-noise ratio, especially in the short-wave range.

3. (EF 41), ECH 42 (or ECH 41), EF 41, EBC 41, EL 41, AZ 41 (or EZ 40), EM 34

Standard valve series for receivers employing the EBC 41 for A.F. amplification.

4. EAF 42, ECH 42, EAF 42, EF 40, EL 41, AZ 41 (or EZ 40), EM 34

A quality receiver using the EF 40 for A.F. amplification and the diodes of the R.F. and I.F. amplifying valves EAF 42 for detection and A.G.C.

5. EF 41, ECH 42, EF 41, EB 41, EF 40, EL 41, AZ 41 (or EZ 40), EM 34

Corresponds very closely to the arrangement given in para. 4, the only difference being that the diodes of the EB 41 can be used for detection and A.G.C.

6. EAF 42, ECH 42, EAF 42, ECH 42 (or ECC 40), 2×EL 41, 2×AZ 41 (or 2×EZ 40), EM 34

A set giving a large output, using relatively few valves.

7. EF 41, ECH 42, EF 41, EF 40, EBC 41, 2×EL 41, 2×AZ 41 (or 2×EZ 40), EM 34

A high-quality receiver, with the EF 41 for R.F. and I.F. amplification, the ECH 42 as frequency changer and the EF 40 for A.F. amplification. The diodes of the EBC 41 can be used for detection and A.G.C., with the triode as phase inverter for the push-pull output stage comprising the two EL 41 valves.

8. EF 41, ECH 42, EAF 42, EAF 42, EL 42, (EZ 41)

A car-radio receiver using the R.F. amplifier EF 41 and the low consumption output valve EL 42.

AZ 41 Full-wave rectifying valve

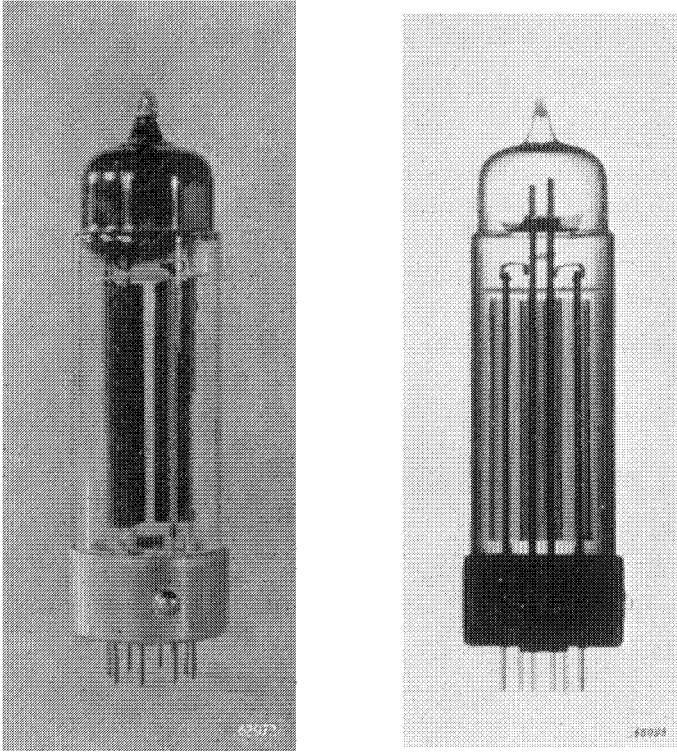

Fig. 1

Normal and X-ray photographs of the AZ 41 (approximately actual size).

The AZ 41 is a directly heated, high-vacuum, full-wave rectifier capable of delivering a current of 70 mA for a transformer voltage of $2 \times 300 V_{RMS}$. This is sufficient to supply a receiver containing the valves ECH 42 (or ECH 41), $2 \times$ EAF 42 and EL 41, leaving enough in hand to operate an extra R.F. stage and tuning indicator.

For higher transformer voltages, up to a maximum of $2 \times 500 V_{RMS}$, the valve will deliver 60 mA.

In order to avoid sputtering, or momentary flash-over between filament and anode, a D.C. resistance R_t , the minimum value of which is specified in the following table, should be included in each of the anode circuits. In practice, this resistance R_t is often present in the form of the D.C. resistance of the primary and secondary windings of the mains transformer.

Let R_p be the D.C. resistance of the primary, R_s that of half the secondary,

AZ 41

and n the transformation ratio between the primary and half the secondary winding. The effective resistance R_t in each anode circuit is then given by:

$$R_t = R_s + n^2 R_p.$$

If the value thus obtained is less than the minimum value specified in the operating data, extra resistance must be added in each anode circuit.

TECHNICAL DATA OF THE FULL-WAVE RECTIFIER AZ 41

Filament data

Heating : direct by A.C.

Filament voltage	V_f	=	4.0 V
Filament current	I_f	=	0.72 A

Limiting values

Alternating input voltage	V_{tr}	=	2 × 300	2 × 400	2 × 500	V_{RMS}
Direct-current output	I_o	=	max. 70	60	60	mA
Total resistance in anode circuits (minimum)	R_t	=	2 × 100	2 × 150	2 × 200	Ω
Input capacitance of smoothing filter	C_{filt}	=	max. 50	50	50	μF

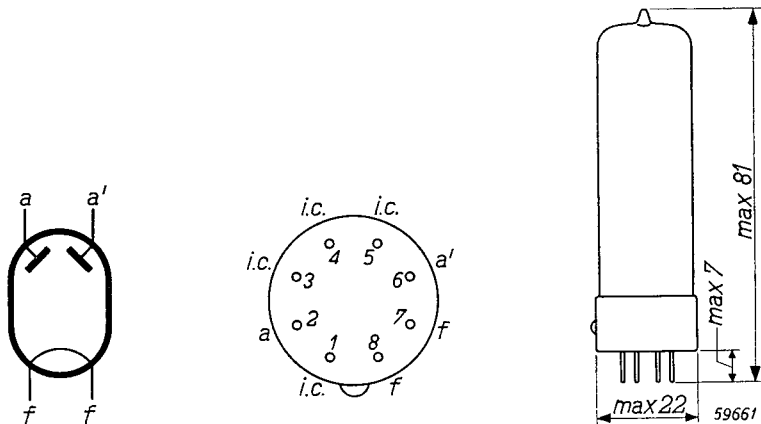

Fig. 2. Electrode arrangement, electrode connections and maximum dimensions in mm. The letters i.c. at pins 1, 3, 4 and 5 indicate that these pins must not be connected externally for any purpose whatsoever.

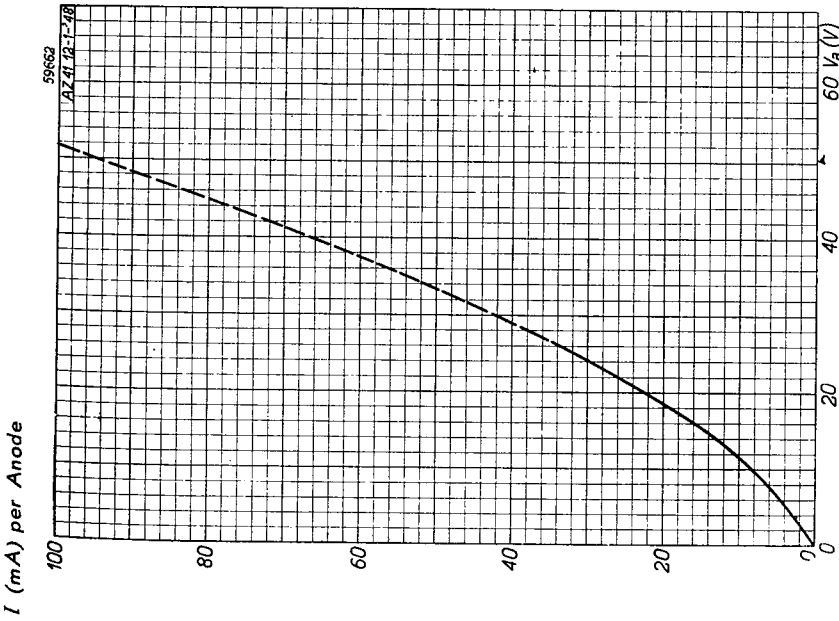

Fig. 3. Anode current (I_a) per anode as a function of the anode voltage (V_a). As the maximum permissible current is 35 mA per anode, the curve above this point is shown by a dotted line.

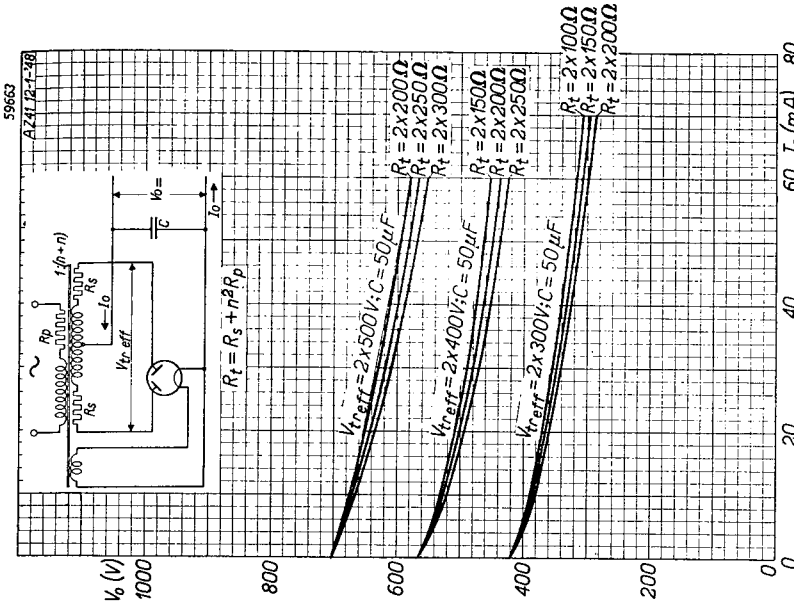

Fig. 4. Regulation curves of the AZ 41 (D.C. output voltage V_o as a function of the direct output current I_o).

EAF 42

EAF 42 (EAF 41) Diode-Pentode

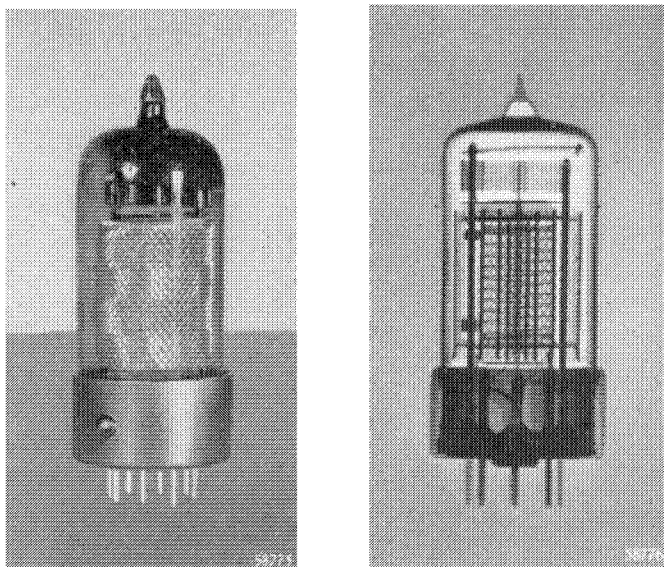

Fig. 1
Normal and X-ray photos of the EAF 42 (approximately actual size).

The EAF 42 is a diode-pentode having variable- μ characteristics, and can be used with a sliding screen grid voltage ; the pentode section is intended for use as a R.F., I.F., or A.F. amplifier, the slope at the working point being 2.15 mA/V (1.8 mA/V in the EAF 41) and the internal resistance 1.4 M Ω (EAF 41 - 1.2 M Ω). The diode part serves for detection or other purposes such as automatic gain control. There is no very great difference between the electrical characteristics of the EAF 41 and EAF 42 ; the main physical difference lies in the connection of the third grid, for in the EAF 41 this is connected internally to the cathode, whereas in the EAF 42 it has a separate pin in the valve base. This is a distinct advantage in small receivers having only four Rimlock valves, e.g. ECH 42 (or ECH 41) frequency changer, EAF 42 I.F. amplifier, detector and *delayed* gain control, EL 41 output valve and AZ 41 or EZ 40 rectifier. In spite of the small number of valves, a receiver of this type can be quite sensitive, its other qualities being improved by the delay on the gain control. Delay is obtained by employing the separately connected third grid of the EAF 42 as the so-called "delay diode". Further details are given in the following pages. If an EAF 41 be used instead of the EAF 42 in a receiver of this kind, the gain control cannot

be delayed, or at best only with difficulty, and the advantages of this arrangement are then lost¹⁾).

EAF 42 as I.F. amplifier

In the circuit of Fig. 2 the pentode section of the first valve EAF 42 is used as an I.F. amplifier with a sliding screen grid voltage; the optimum values for the series resistor are indicated in the table at the end of this section. In this circuit a control voltage of about 43 V applied to the control grid reduces the slope to 1/100 of the original value. If the EAF 42 and the ECH 41 or ECH 42 are employed together, the screen grids of the frequency changer

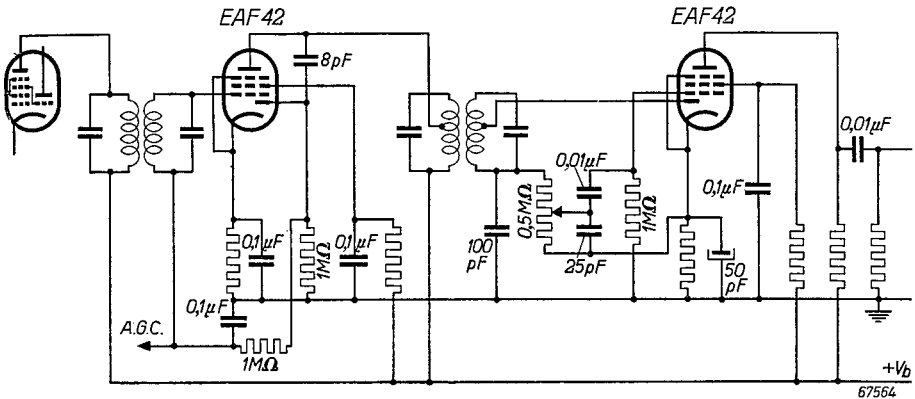

Fig. 2

Circuit diagram showing the EAF 42 as an I.F. amplifier (left-hand valve) and as a resistance-coupled A.F. amplifier (right-hand valve). The diode of the first valve is used for automatic gain control and that of the second as detector; the values of the resistors not indicated above will be found in the tables at the end of this section.

valve and the I.F. amplifier EAF 42 can be fed from the same potentiometer, thus saving the extra components (see Fig. 3). Further particulars of such a circuit will be found in the description of the ECH 42, whilst data relating to the EAF 42 in this circuit are included among the tables and characteristics at the end of this section.

Adequate screening is ensured by a metal cage surrounding the pentode section of the valve; external screening is therefore unnecessary. Special attention has also been given to the screening between control grid and anode; the

¹⁾ For this reason the EAF 41 in its original form is no longer being manufactured, but is replaced by the EAF 42. For replacement purposes in the re-valving of a set, the EAF 42 can take the place of the EAF 41, it being only necessary to short-circuit sockets 4 and 7 of the valveholder (see Fig. 8); in this way the connection between the third grid and the cathode (which is inside the EAF 41) is established externally of the EAF 42. In numerous receivers fitted with the EAF 41 this connection is already established.

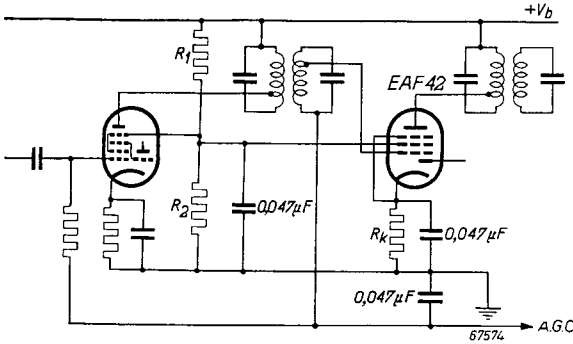

Fig. 3

Circuit in which the screen grids of the frequency changer (ECH 41 or ECH 42) and the I.F. amplifier (EAF 42) are fed from a common potentiometer, R_1 , R_2 .

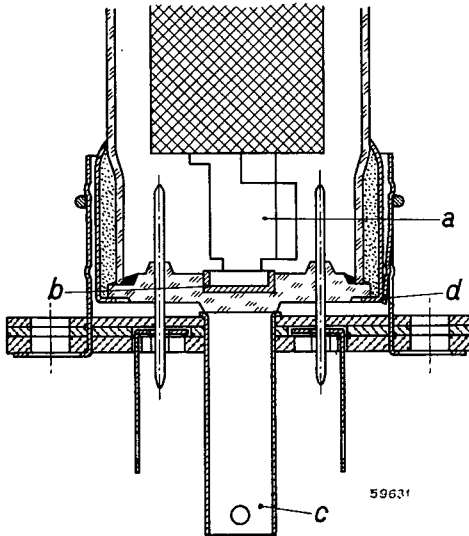

Fig. 4

Screening between anode and control grid in the EAF 42: a is a shield between the diametrically opposite anode and grid pins; b is a metal plate mounted in a recess in the glass base between the pins; c is a metal bush between the contacts of the valveholder.

respective pins are diametrically opposite each other on the base, and a shield is provided between these pins within the envelope (a , Fig. 4). This shield is continued underneath the base of the valve by a metal bush (c), connected to earth, which is fixed in the centre of the valveholder.

In order that the internal and external shielding shall be as continuous as possible, a further metal plate b is mounted in a small recess in the glass base, and is connected to the other shields in the valve. By this means it has been possible to reduce the anode-grid capacitance to something less than 0.002 pF, but in order to maintain this low capacitance it is essential to press the valve well home in the valveholder to minimize the gap between internal and external shields. It is also necessary to see that the metal skirt at the base of the valve is properly earthed (see note on page 18), by bending the lugs on the metal rim of the valveholder before inserting the valve, to ensure proper contact between this earthed rim and the skirt on the valve (see d in Fig. 4).

When calculating the amount of feedback the grid circuit of the EAF 42 when it is used as an I.F. amplifier, it must be remembered that feedback occurs not only from the anode of the pentode but also from that of

the diode. If the latter is employed for automatic gain control, it will usually be connected to the first tuned circuit of the I.F. transformer, to which the pentode anode is also connected. The I.F. voltages on the anodes of the

diode and pentode are thus in phase and of the same order of size, so that the effective feedback capacitance is roughly equal to the anode-to-grid capacitance plus the diode-grid capacitance ($C_{ag1} < 0.002$ pF, $C_{dg1} < 0.0015$ pF); on the other hand, if the diode is used for detection purposes, it is usually connected to the secondary of the I.F. transformer, in which case the diode voltage is 90° out of phase with the pentode anode voltage and will have a damping effect on the grid circuit.

In either case the feedback, even when high-quality coils are used ($Q=180$ to 200), will not have any serious consequences, provided that wiring capacitances are kept as low as possible. This can be achieved by fitting a screening plate under the valveholder, between pins 3 and 4, 6 and 7 (see Figs. 7 and 8).

EAF 42 as A.F. amplifier

In Fig. 2 the second EAF 42 is shown connected as an A.F. amplifier; tables are included in the technical data at the end of this section indicating the amplification and distortion for a number of different circuits, with various combinations of resistors and for several values of the control voltage. Fig. 5

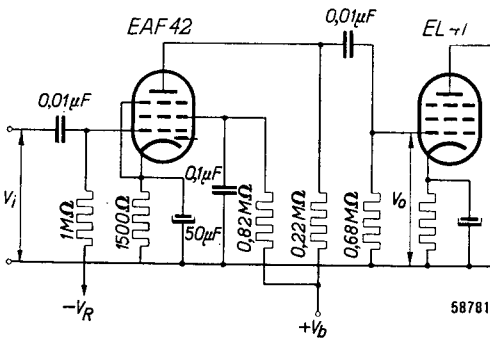

Fig. 5

Circuit diagram showing the EAF 42 as a resistance-coupled A.F. amplifier with control ($-V_R$) on the grid.

is an example of the circuits in question, but, before looking more closely at the details, it may be better to consider the question of hum in the EAF 42 when used as a voltage amplifier, and, in particular, the hum produced by the magnetic field of the heater. As the EAF 42 is a variable- μ valve, it has a variable pitch grid, which means that the pitch of part of the grid is relatively wide, and it would seem to be more especially those electrons that pass between the widely spaced turns of the grid which are affected by the magnetic field produced by the heater. The result is a higher hum voltage than otherwise, especially when gain control is applied, as the greater part of the electrons then find their way through the more widely spaced turns of the grid. It may therefore be concluded that control applied to the A.F. amplifier will generally increase the equivalent hum voltage on the control grid, whilst a variable- μ valve is, from the point of view of hum, not the best kind of valve to use for A.F. amplification.

From the tables on page 43 it will be seen that the maximum obtainable amplification is 120, but as such a high gain is not usually required, the reserve can be used for negative feedback purposes and the quality of reproduction thereby considerably improved. A feedback factor of 6 or 7, which will reduce the distortion by the same amount, still leaves a total effective gain of about 20 in the A.F. stage.

EAF 42

Another reason why the full extent of the gain should not be utilized in the case of the EAF 42 is related to the possibility of microphony; in many cases it will be found necessary to take special precautions in this direction. Some idea of the A.F. gain that may be obtained from the EAF 42 without risk of microphony is given by the fact that a circuit driving a loudspeaker with an acoustic efficiency of 5% will not usually necessitate any special precautions to prevent microphony when the control grid of the EAF 42 requires an A.F. input of at least 10 mV for 50 mW to be delivered to the speaker.

To illustrate the practical significance of this value of 10 mV, let us take the case of a circuit using an EAF 42 as the A.F. pre-amplifier and an EL 41 as the output valve. To produce an output of 50 mW the EL 41 requires an alternating input voltage of 0.32 V: if the voltage amplifier has a gain of 20 — this being usually considered sufficient — it will require an input of 16 mV, and this is well above the minimum value of 10 mV.

In fixing this limit, above which no trouble from microphony is met with, external influences such as cabinet resonance, which impose heavy requirements on the microphonic properties of the valve, have not been taken into account.

In such cases, as also when still more gain is required, it will generally be found necessary to take steps to avoid microphony, such as the use of anti-microphonic valveholders, or a vibration-damping cover on the valve itself. In the table on page 45 the gain of the EAF 42 is given for a grid leak of 10 M Ω , with no cathode resistor. A grid leak of such high value may be used only if no extra source of grid bias is available: the reasons for this will be found in the description of the EBC 41.

Detection and automatic gain control

a. *Detection and A.G.C. using two EAF 42 valves*

In the circuit diagram of Fig. 2 the diode of the second EAF 42 functions as detector, whilst that of the first valve serves for the A.G.C.; the detector diode is connected to the secondary of the I.F. transformer and the A.G.C. diode to the primary. As the diodes are in different valves, there is no need to take any steps to minimize capacitance between them.

In the EAF 42 the diode anode is connected internally to the most suitable pin, to ensure a minimum of coupling between diode and pentode sections, but in order to keep the capacitance between the leads to the respective electrodes as low as possible, it is essential to fit a screening plate below the valveholder, between contacts 3 and 4, and 6 and 7, in the manner shown in Figs. 7 and 8.

Apart from the circuit under review, in which the diode of the A.F. amplifier is used for detection and that of the I.F. amplifier for A.G.C., it is also possible to reverse the functions of these diodes, although there is a disadvantage in so doing, in that, when the volume control is turned right back, any residual signal will be distorted. Such a signal is likely to occur, if only weakly, because the A.F. voltage on the diode of the EAF 42 used as A.F. amplifier tends to reach high values on strong input signals.

There need only be the slightest coupling between this diode and the pentode-anode to convey an A.F. signal to the latter, and, as this anode follows the volume control in the circuit, any such signal will be at once audible in the speaker. When the signal comes from the detector diode it is not distorted, since the A.F. voltage on that diode does not usually suffer from distortion, in contrast with the A.F. voltage on the A.G.C. diode which, owing to the bias voltage employed for the delaying action, is distorted and unpleasant to the ear.

In cases where the bias on the I.F. valve is derived from a cathode resistor, a further consequence of the interchange of the diode functions is that the control voltage increases less rapidly. When control is applied to the I.F. valve in the circuit shown in Fig. 2, the voltage across the cathode resistor, and therefore also the delay voltage for the diode, disappear, and the latter then supplies a higher control voltage.

b. *Detection and A.G.C. using one EAF 42*

As already mentioned, a receiver can be designed round the ECH 42 (or ECH 41), EAF 42, EL 41 and AZ 41 or EZ 40, which, despite the small number of valves, will still be reasonably sensitive. Since a circuit of this kind includes only one diode, this must serve for both detection and A.G.C. There is no objection to this, but, if the EAF 41 is used instead of the EAF 42, it is not a simple matter to delay the A.G.C., since a bias on the diode-anode, as frequently employed to produce the delaying effect, cannot then be used, as this prevents detection of weak signals. Moreover, neither the EAF 41 nor any of the other valves has an electrode suitable for use as so-called delay diode. (The action of such a diode will be explained in the following.) When the EAF 41 is used, therefore, the A.G.C. must be undelayed, but this involves certain difficulties, which are best illustrated by means of two extreme examples.

In the first case the whole of the rectified voltage from the diode is used for the A.G.C. This results in a very strong gain control and, also, noticeable attenuation of the weaker signals, which is not desirable. Further, with such control the output valve is driven fully only on strong signals. On the other hand, if only a small portion of the rectified voltage is taken for the purpose of A.G.C., these objections are certainly eliminated, but the control is then inadequate in the face of strong signals, and high I.F. voltages occur which, especially on deeply modulated signals, are likely to give rise to modulation distortion.

Naturally, a more or less satisfactory compromise can be made between these evils by allocating a suitable proportion of rectified voltage from the detector to the A.G.C., but better results are usually obtained when the control is delayed so as to attenuate the strong signals and not the weak ones; the output valve is then also able to deliver its full output on fairly weak signals.

The EAF 42 enables such delay to be applied quite conveniently, the separately connected third grid being then employed as "delay diode"; the relative circuit diagram is shown in Fig. 6. A potentiometer comprising R_1 (20 M Ω),

EA F 42

R_2 (1.5 M Ω) and R_3 (2.7 M Ω) is introduced between the H.T. voltage V_b (250 V) and a voltage of -7 V obtained from the bias on the output valve EL 41. The junction A between resistors R_1 and R_2 is connected to the third grid of the EA F 42 and further, through R_4 (1.8 M Ω), to a point B in the detector circuit. From another point C at the junction of resistors R_2 and R_3 the necessary bias $-V_R$ for the control grids of the frequency changer and I.F. amplifier is obtained. The various resistance values are so arranged as to give point A a small positive potential ($V_{g3} < 1$ V) with respect to cathode when no signal is being received.

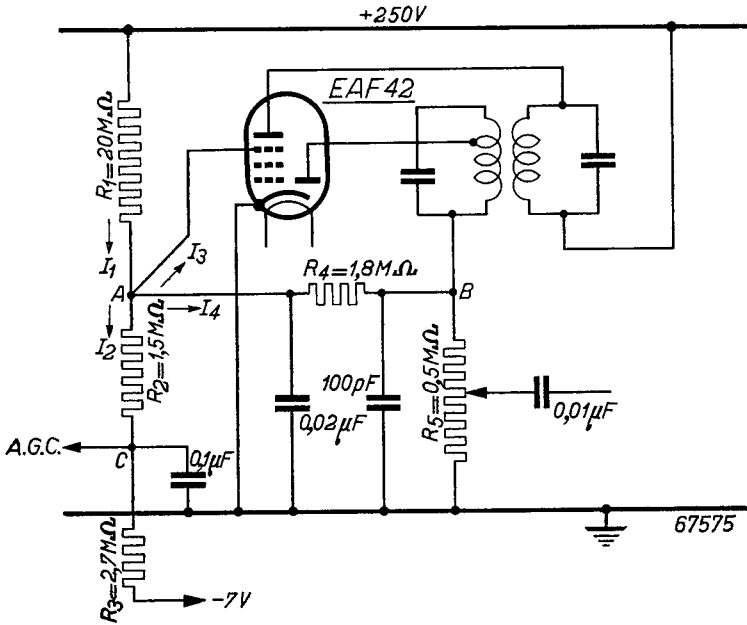

Fig. 6
Circuit diagram showing the EA F 42 used as an I.F. amplifier with the diode employed for detection and A.G.C., the third grid functioning as "delay diode".

By means of the given voltages and resistance values it is a simple matter to calculate that in this case the potential $-V_R$ will be about -2 V. This determines the working point of the frequency changer and I.F. amplifier. The values of the currents to and from point A are also easily computed. It is found that the current I_1 flowing in resistor R_1 is $12.5 \mu\text{A}$, the current I_2 in resistor R_2 is $1.9 \mu\text{A}$ and the current I_4 in resistor R_4 $0.4 \mu\text{A}$. Voltage V_{g3} , that is the potential at point A, can be expressed to a close approximation as $V_{g3} = V_{g3_0} + I_3 \cdot R_{g3}$, in which V_{g3_0} is the contact potential of the

third grid with respect to cathode and R_{g3} the internal resistance of the third grid, also to cathode.

Now, when an I.F. signal of gradually increasing strength is applied to the diode, the effect of detection is to render point B negative with respect to earth; the current I_4 therefore increases. As current I_1 is kept practically constant by the high resistance of R_1 (20 M Ω), whilst I_2 — and therefore also the variation in I_2 — may be ignored at a first approximation, the increase in I_4 takes place at the cost of I_3 . So long as the current I_3 exists, however, the potential at point A will differ but slightly from that of the cathode. If the I.F. signal increases so much that $I_3=0$, V_{g3} has decreased from its original small positive value to V_{g3c} , which also differs only slightly from 0 V. Since the bias on the EL 41 remains unchanged at -7 V, the voltage $-V_R$ does not alter very much either. Thus no control is applied to the frequency changer and I.F. valve so long as the current I_3 flows. However, as soon as the I.F. signal becomes so strong that the current I_3 disappears altogether, the increase in I_4 takes place at the cost of I_2 , since I_1 cannot undergo any great change owing to the presence of the series-resistor of 20 M Ω .

From the circuit diagram it will be clearly seen that a reduction in I_2 (whereby I_2 may also change direction) renders C still more negative, so that control is applied to the valves.

Let us now see at what point the control begins to take effect. As mentioned above, this occurs when the current I_3 drops to zero. Now, this current is 10.2 μ A in the absence of a signal, which means that the control commences to operate when the current I_4 is increased to about 10 μ A by the I.F. signal: in actual fact, I_4 is 10.8 μ A at the moment when $I_3=0$. A current I_4 of 10.8 μ A means that there is a direct voltage of $10.8 \times 1.8 = 19.4$ V across resistor R_4 , and this voltage also occurs across the volume control R_5 , corresponding at the same time to the peak carrier voltage of the detected I.F. signal. Assuming that the modulation depth of the I.F. signal is 30%, the volume control will carry an A.F. signal of which the R.M.S. voltage is $0.3 \cdot 19.4/\sqrt{2} = 4.1$ V. At this voltage, which is roughly what is required to load fully the output valve EL 41, the automatic gain control commences to operate. In the foregoing, the various resistance values are introduced without further elucidation; naturally there is a certain freedom of choice in fixing the resistance values, and, with slightly modified conditions, it is quite possible that values other than those indicated would give better results. This point is referred to again in the description of a receiver incorporating the circuit described above (see page 137).

TECHNICAL DATA OF THE DIODE-PENTODE EAF 41

Heater data

Heating : Indirect, A.C. or D.C., parallel feed

Heater voltage V_f	=	6.3 V
Heater current I_f	=	0.2 A

EAF 41

Capacitances (measured on the cold valve)

Pentode section

Input capacitance	C_{pi}	=	4.0 pF
Output capacitance	C_a	=	6.5 pF
Anode - control grid	C_{ag1}	<	0.002 pF
Heater - control grid	C_{gf}	<	0.05 pF

Diode section

Anode - cathode	C_d	=	3.8 pF
Anode - heater	C_{df}	<	0.02 pF

Between diode and pentode sections

Diode anode - pentode control grid	C_{dgi}	<	0.0015 pF
Diode anode - pentode anode	C_{da}	<	0.15 pF

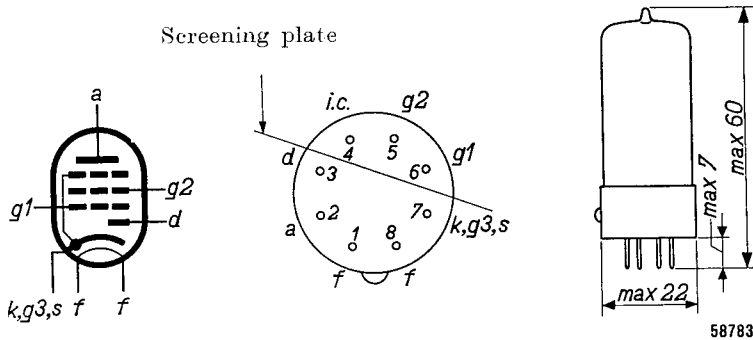

Fig. 7

Electrode arrangement, electrode connections and maximum dimensions in mm of the EAF 41. The screening plate, indicated by a line through the centre diagram, obviates undesirable coupling in the wiring. The letters i.c. at pin 4 indicate that this pin is internally connected to the electrode system and must not be connected to the external circuit.

Operating characteristics of the pentode section used as a R.F. or I.F. amplifier

(Circuit similar to that of the left-hand EAF 42 in Fig. 2)

Anode and supply voltage	$V_a = V_b$	=	250	V
Screen grid resistor	R_{g2}	=	95	k Ω
Cathode resistor	R_k	=	300	Ω
Grid bias	V_{g1}	=	-2	-40 V
Screen grid voltage	V_{g2}	=	100	250 V
Anode current	I_a	=	5.0	— mA
Screen grid current	I_{g2}	=	1.6	— mA
Mutual conductance	S	=	1800	18 $\mu\text{A/V}$
Internal resistance	R_i	=	1.2	> 10 M Ω
Equivalent noise resistance	R_{eq}	=	9.0	— k Ω
Amplification factor of grid 2 with respect to grid 1	μ_{g2g1}	=	19	—

Operating characteristics of the pentode section used as a resistance-coupled A.F. amplifier (circuit similar to Fig. 5)

A. Supply voltage $V_b=250$ V Anode resistor $R_a=0.2$ M Ω
 Cathode resistor $R_k=1.6$ k Ω Screen grid resistor $R_{g2}=0.8$ M Ω

Control voltage $-V_R$ (V)	Anode current I_a (mA)	Screen grid current I_{g2} (mA)	Amplification V_o/V_i	Distortion (%) for an output of		
				3 V_{RMS}	5 V_{RMS}	10 V_{RMS}
0	0.86	0.28	105	1.0	1.5	2.7
5	0.68	0.22	33	1.0	1.6	3.5
10	0.56	0.18	21	1.1	1.8	3.9
18	0.39	0.12	12	1.3	2.0	5.0
25	0.24	0.08	8	1.8	2.8	7.5

B. Supply voltage $V_b=250$ V Anode resistor $R_a=0.1$ M Ω
 Cathode resistor $R_k=900$ Ω Screen grid resistor $R_{g2}=0.4$ M Ω

Control voltage $-V_R$ (V)	Anode current I_a (mA)	Screen grid current I_{g2} (mA)	Amplification V_o/V_i	Distortion (%) at an output of		
				3 V_{RMS}	5 V_{RMS}	10 V_{RMS}
0	1.57	0.50	85	0.9	1.3	2.5
5	1.18	0.37	29	1.1	1.6	3.5
10	0.91	0.28	16	1.3	2.2	4.1
18	0.60	0.18	9.5	1.6	2.8	5.5
25	0.36	0.12	6	2.5	4.1	9.0

EAF 41

Operating characteristics of the pentode section used as a resistance-coupled A.F. triode (screen grid connected to anode).

A. Supply voltage $V_b=250$ V Anode resistor $R_a=0.1$ M Ω
 Cathode resistor $R_k=900$ Ω

Control voltage $-V_R$ (V)	Anode current $I_a + I_{g2}$ (mA)	Amplification V_o/V_i	Distortion (%) at an output of		
			3 V_{RMS}	5 V_{RMS}	10 V_{RMS}
0	1.96	15.5	1.4	2.0	5.2
5	1.40	8	1.0	1.7	3.8
10	1.10	6	0.9	1.4	3.0
18	0.75	4.5	1.2	1.6	3.3
25	0.45	3.3	1.6	2.2	5.2

B. Supply voltage $V_b=250$ V Anode resistor $R_a=0.05$ M Ω
 Cathode resistor $R_k=500$ Ω

Control voltage $-V_R$ (V)	Anode current $I_a + I_{g2}$ (mA)	Amplification V_o/V_i	Distortion (%) at an output of		
			3 V_{RMS}	5 V_{RMS}	10 V_{RMS}
0	3.60	15.5	1.1	1.8	3.8
5	2.50	8	1.3	2.0	4.5
10	1.85	5.9	1.1	1.7	4.0
18	1.14	3.8	1.5	2.0	5.0
25	0.65	2.8	2.4	3.5	8.0

Limiting values of the pentode section

Anode voltage, valve biased to cut-off	V_{a_c}	= max.	550 V
Anode voltage	V_a	= max.	300 V
Anode dissipation	W_a	= max.	2 W
Screen grid voltage, valve biased to cut-off	V_{g2_0}	= max.	550 V
Screen grid voltage, with control	$V_{g2}(I_a < 2.5 \text{ mA})$	= max.	300 V
Screen grid voltage, without control	$V_{g2}(I_a = 5 \text{ mA})$	= max.	125 V
Screen grid dissipation	W_{g2}	= max.	0.3 W
Cathode current	I_k	= max.	10 mA
Grid current starting point	$V_{g1}(I_{g1} = +0.3 \text{ } \mu\text{A})$	= max.	-1.3 V
External resistance between grid 1 and cathode	R_{g1}	= max.	3 M Ω
External resistance between heater and cathode	R_{fk}	= max.	20 k Ω
Voltage between heater and cathode	V_{fk}	= max.	50 V

Limiting values of the diode section

Peak inverse anode voltage	$V_{dinv p}$	= max. 350 V
Diode current	I_d	= max. 0.8 mA
Peak diode current	I_{dp}	= max. 5 mA
Diode current starting point	$V_a(I_d = +0.3 \mu A)$	= max. -1.3 V
External resistance between heater and cathode	R_{fk}	= max. 20 k Ω
Voltage between heater and cathode	V_{fk}	= max. 50 V

TECHNICAL DATA OF THE DIODE-PENTODE EAF 42

Heater data

Heating : Indirect, A.C. or D.C., parallel feed

Heater voltage	V_f	= 6.3 V
Heater current	I_f	= 0.2 A

Capacitances

Pentode section

Input capacitance	C_{g1}	= 4.1 pF
Output capacitance	C_a	= 5.2 pF
Anode - control grid	C_{ag1}	< 0.002 pF
Heater - control grid	C_{g1f}	< 0.05 pF

Diode section

Anode - cathode	C_d	= 3.3 pF
Anode - heater	C_{af}	< 0.02 pF

Between diode and pentode sections

Diode anode - pentode control grid	C_{dg1}	< 0.0015 pF
Diode anode - Pentode anode	C_{da}	< 0.15 pF

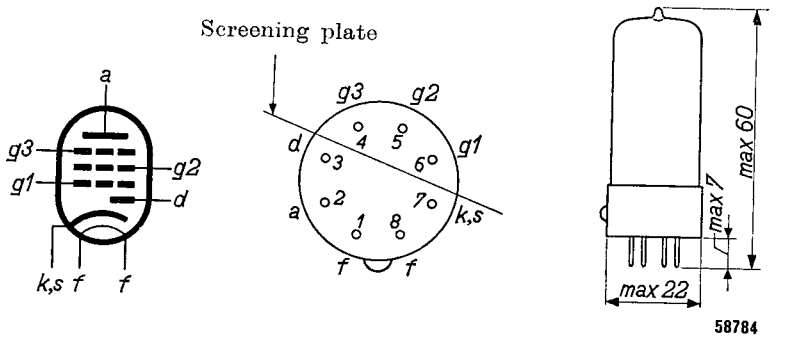

Fig. 8

Electrode arrangement, electrode connections and maximum dimensions in mm of the EAF 42. The screening plate shown in the centre diagram serves to reduce unwanted coupling in the wiring.

EAF 42

Operating characteristics of the pentode section used as a R.F. or I.F. amplifier

(For circuit diagram see left-hand EAF 42 in Fig. 2.)

Anode and supply voltage	$V_a = V_b$	=	250	V
Voltage, third grid	V_{g3}	=	0	V
Screen grid resistor	R_{g2}	=	110	k Ω
Cathode resistor	R_k	=	310	Ω
Grid bias	V_{g1}	=	-2	-43 V
Screen grid voltage	V_{g2}	=	85	250 V
Anode current	I_a	=	5.0	— mA
Screen grid current	I_{g2}	=	1.5	— mA
Mutual conductance	S	=	2000	20 μ A/V
Internal resistance	R_i	=	1.4	> 10 M Ω
Equivalent noise resistance	R_{cq}	=	7.5	— k Ω
Amplification factor of grid 2 in respect of grid 1	μ_{g2g1}	=	16	—

Anode and supply voltage	$V_a = V_b$	=	250	V
Voltage, third grid	V_{g3}	=	0	V
Screen grid resistor	R_{g2}	=	68	k Ω
Cathode resistor	R_k	=	220	Ω
Grid bias	V_{g1}	=	-2	-43 V
Screen grid voltage	V_{g2}	=	105	— V
Anode current	I_a	=	6.9	— mA
Screen grid current	I_{g2}	=	2.1	— mA
Mutual conductance	S	=	2150	21.5 μ A/V
Internal resistance	R_i	=	1.4	> 10 M Ω
Equivalent noise resistance	R_{cq}	=	9	— k Ω
Amplification factor of grid 2 in respect of grid 1	μ_{g2g1}	=	16	—

Operating characteristics of the pentode section used as a R.F. or I.F. amplifier

(Screen grids of EAF 42 and ECH 41 fed by means of a common potentiometer; see Fig. 3, page 32. For details of the ECH 41 in this circuit, see page 69.)

Anode and supply voltage	$V_a = V_b$	=	250	V
Voltage, third grid	V_{g3}	=	0	V
Potentiometer for screen grid voltage supply	$\left\{ \begin{matrix} R_1 \\ R_2 \end{matrix} \right.$	=	18	k Ω
Cathode resistor	R_k	=	27	k Ω
		=	220	Ω
Grid bias	V_{g1}	=	-2	-23.5 V
Screen grid voltage	V_{g2}	=	105	147 V
Anode current	I_a	=	6.9	— mA
Screen grid current	I_{g2}	=	2.1	— mA
Mutual conductance	S	=	2150	21.5 μ A/V
Internal resistance	R_i	=	1.4	> 10 M Ω
Equivalent noise resistance	R_{cq}	=	9	— k Ω
Amplification factor of grid 2 with respect to grid 1	μ_{g2g1}	=	16	—

Operating characteristics of the pentode section used as a R.F. or I.F. amplifier
 (Screen grids of the EAJ 42 and ECH 42 fed by means of a common potentiometer, see Fig. 3, page 32. For details of the ECH 42 in this circuit, see page 80.)

Anode and supply voltage	$V_a = V_b$	=	250	V
Voltage, third grid	V_{g3}	=	0	V
Potentiometer for screen grid voltage supply	$\begin{cases} R_1 \\ R_2 \end{cases}$	=	22	k Ω
Cathode resistor	R_k	=	27	k Ω
		=	310	Ω
Grid bias	V_{g1}	=	-2 -20.5 V	
Screen grid voltage	V_{g2}	=	85	137 V
Anode current	I_a	=	5.0	— mA
Screen grid current	I_{g2}	=	1.5	— mA
Mutual conductance	S	=	2000	20 μ A/V
Internal resistance	R_i	=	1.4	> 10 M Ω
Equivalent noise resistance	R_{eq}	=	7.5	— k Ω
Amplification factor of grid 2 in respect of grid 1	μ_{g2g1}	=	16	—

Operating characteristics of the pentode section used as a resistance-coupled A.F. amplifier (Fig. 5)

A. Supply voltage $V_b=250$ V Anode resistor $R_a=0.22$ M Ω
 Cathode resistor $R_k=1.5$ k Ω Screen grid resistor $R_{g2}=0.82$ M Ω

Control voltage — V_R (V)	Anode current I_a (mA)	Screen grid current I_{g2} (mA)	Amplification V_o/V_i	Distortion (%) at an output of		
				3 V_{RMS}	5 V_{RMS}	8 V_{RMS}
0	0.80	0.26	120	0.9	1.0	1.2
5	0.65	0.20	40	1.3	1.5	2.5
10	0.52	0.17	23	1.3	1.6	2.7
15	0.41	0.14	16	1.5	2.0	3.2
20	0.31	0.11	11	1.8	2.7	5.5

B. Supply voltage $V_b=250$ V Anode resistor $R_a=0.1$ M Ω
 Cathode resistor $R_k=680$ Ω Screen grid resistor $R_{g2}=0.39$ M Ω

Control voltage — V_R (V)	Anode current I_a (mA)	Screen grid current I_{g2} (mA)	Amplification V_o/V_i	Distortion (%) at an output of		
				3 V_{RMS}	5 V_{RMS}	8 V_{RMS}
0	1.52	0.53	100	0.8	0.9	1.0
5	1.20	0.40	35	1.0	1.4	2.4
10	0.94	0.30	20	1.2	2.0	3.2
15	0.70	0.23	13	1.4	2.3	3.7
20	0.52	0.17	9	1.8	3.0	6.0

EAF 42

Operating characteristics of the pentode section used as a resistance-coupled A.F. amplifier triode (screen grid connected to anode)

A. Supply voltage $V_b=250$ V Anode resistor $R_a=0.1$ M Ω
 Cathode resistor $R_k=680$ Ω

Control voltage $-V_R$ (V)	Anode current $I_a + I_{g2}$ (mA)	Amplification V_o / V_i	Distortion (%) at an output of		
			3 V_{RMS}	5 V_{RMS}	8 V_{RMS}
0	2.00	15	0.9	1.1	1.2
5	1.50	8.5	1.1	1.6	2.4
10	1.17	6	1.1	1.6	2.4
15	0.90	5	1.1	1.6	2.4
20	0.68	4	1.2	1.7	2.6

B. Supply voltage $V_b=250$ V Anode resistor $R_a=0.05$ M Ω
 Cathode resistor $R_k=390$ Ω

Control voltage $-V_R$ (V)	Anode current $I_a + I_{g2}$ (mA)	Amplification V_o / V_i	Distortion (%) at an output of		
			3 V_{RMS}	5 V_{RMS}	8 V_{RMS}
0	3.80	14	0.7	0.9	1.1
5	2.70	9	1.1	1.6	2.6
10	2.00	6.5	1.1	1.6	2.6
15	1.44	5	1.1	1.6	2.6
20	1.05	4	1.4	2.2	3.4

Operating characteristics of the pentode section used as a resistance-coupled A.F. amplifier, with a large leak resistance in the grid circuit

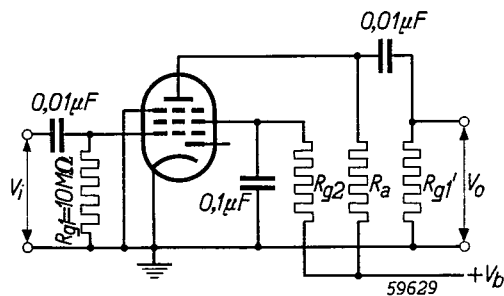

Fig. 9

A. Pentode connection

Supply voltage	V_b	= 250	250 V
Anode resistor	R_a	= 0.22	0.1 MΩ
Screen grid resistor	R_{g2}	= 1.0	0.39 MΩ
Grid leak	R_{g1}	= 10	10 MΩ
Grid leak of output valve	R_{g1}'	= 0.68	0.33 MΩ
Anode current	I_a	= 0.76	1.60 mA
Screen grid current	I_{g2}	= 0.23	0.56 mA
Amplification	V_o/V_i	= 160	100
Distortion at an output of			
3 V_{RMS}	$d_{tot}(V_o=3 V_{RMS})$	= 0.55	0.35 %
5 V_{RMS}	$d_{tot}(V_o=5 V_{RMS})$	= 0.75	0.55 %
8 V_{RMS}	$d_{tot}(V_o=8 V_{RMS})$	= 1.0	0.7 %

B. Triode connection (screen grid connected to anode)

Supply voltage	V_b	= 250	250 V
Anode resistor	R_a	= 0.1	0.047 MΩ
Grid leak	R_{g1}	= 10	10 MΩ
Grid leak of output valve	R_{g1}'	= 0.33	0.15 MΩ
Anode current	I_a	= 2.15	4.50 mA
Amplification	V_o/V_i	= 14	13.5
Distortion at an output of			
3 V_{RMS}	$d_{tot}(V_o=3 V_{RMS})$	= 0.7	0.5 %
5 V_{RMS}	$d_{tot}(V_o=5 V_{RMS})$	= 1.2	0.8 %
8 V_{RMS}	$d_{tot}(V_o=8 V_{RMS})$	= 2.0	1.4 %

Limiting values of the pentode section

Anode voltage, valve biased to cut-off	V_{a_o}	= max.	550 V
Anode voltage	V_a	= max.	300 V
Anode dissipation	W_a	= max.	2 W
Screen grid voltage, valve biased to cut-off	V_{g2_o}	= max.	550 V
Screen grid voltage, controlled valve	$V_{g2}(I_a < 2.5 \text{ mA})$	= max.	300 V
Screen grid voltage, without control	$V_{g2}(I_a = 5 \text{ mA})$	= max.	125 V
Screen grid dissipation	W_{g2}	= max.	0.3 W
Cathode current	I_k	= max.	10 mA
Grid current starting point	$V_{g1}(I_{g1} = +0.3 \text{ } \mu\text{A})$	= max.	-1.3 V
External resistance between grid 1 and cathode	R_{g1}	= max.	3 MΩ ¹⁾

¹⁾ If the working point of the valve is determined only by the potential difference across the grid leak (R_{g1}), i.e. no separate source of bias and no cathode resistor, the maximum value of R_{g1} may be increased to 22 MΩ.

EAF 42

External resistance between grid 3 and cathode . . .	R_{g3}	= max.	3 M Ω
External resistance between heater and cathode . . .	R_{jk}	= max.	20 k Ω
Voltage between heater and cathode	V_{jk}	= max.	100 V

Limiting values of the diode section

Peak inverse anode voltage .	$V_{d \text{ inv } p}$	= max.	350 V
Diode current	I_d	= max.	0.8 mA
Peak diode current	I_{dp}	= max.	5 mA
Diode current starting point	$V_d(I_d = +0.3 \mu\text{A})$	= max.	-1.3 V
External resistance between heater and cathode . . .	R_{jk}	= max.	20 k Ω
Voltage between heater and cathode	V_{jk}	= max.	100 V

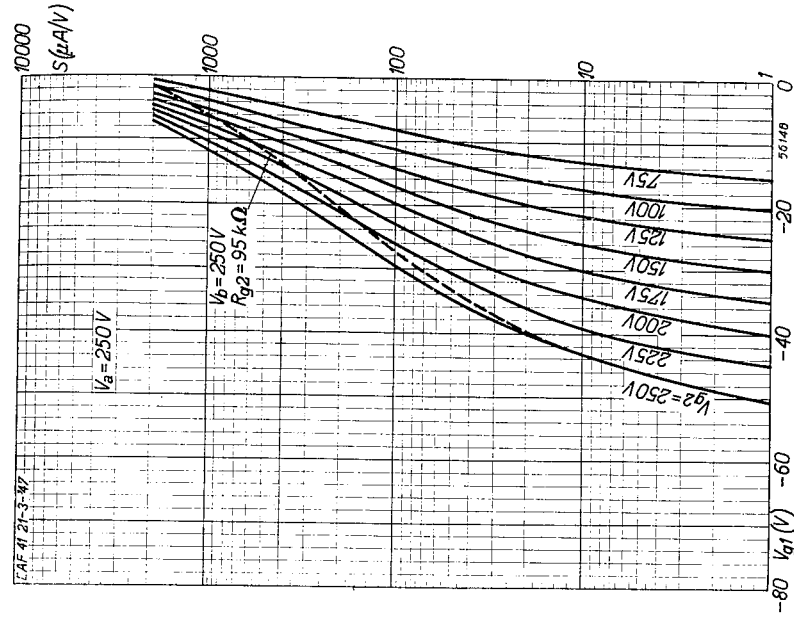

Fig. 11

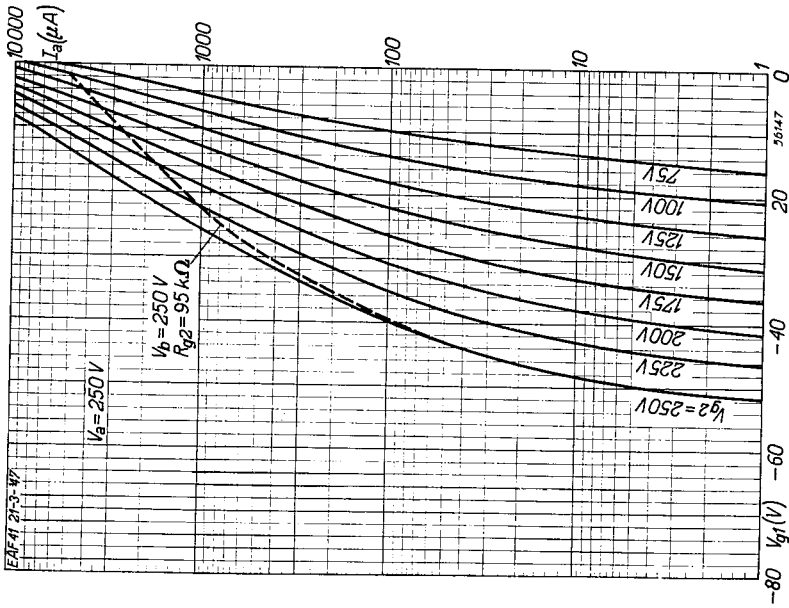

Fig. 10

Anode current (Fig. 10) and mutual conductance (Fig. 11) of the EAF 41 as functions of the grid bias for different screen grid voltages. The broken lines represent the anode current and slope with a 95 kΩ-resistor in series with the screen grid.

EAF 42

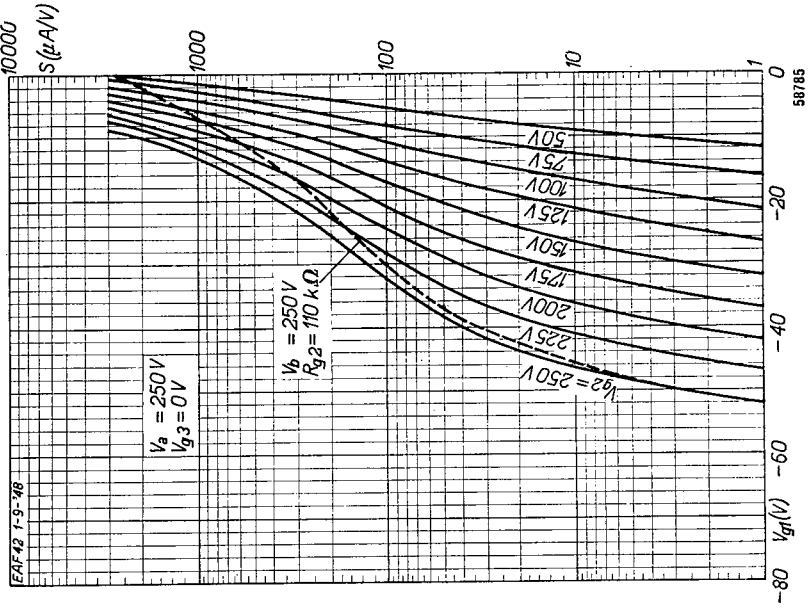

Fig. 13

Fig. 13
 Anode current (Fig. 12) and mutual conductance (Fig. 13) of the EAF 42 as functions of the grid bias for various screen grid voltages. The broken lines represent the anode current and slope of the I.F. valve EAF 42 in the circuit of Fig. 2.

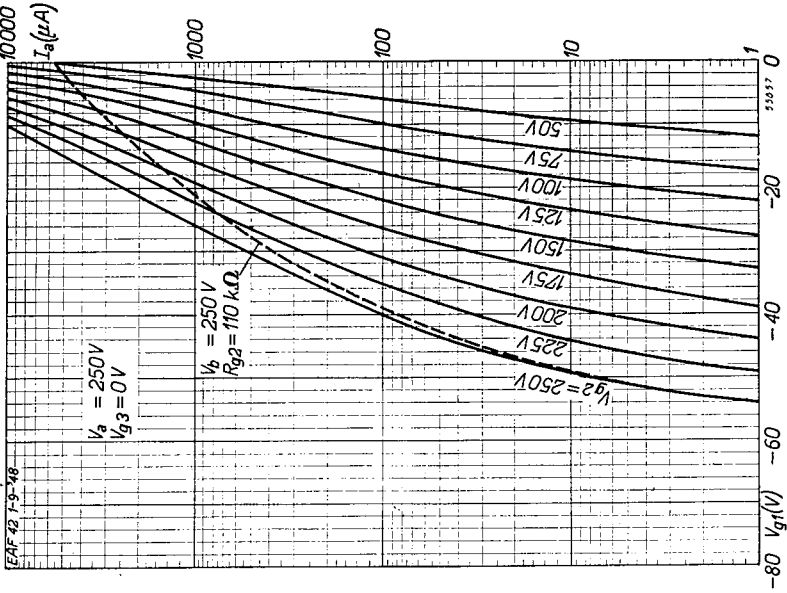

Fig. 12

Fig. 12
 Anode current (Fig. 12) and mutual conductance (Fig. 13) of the EAF 42 as functions of the grid bias for various screen grid voltages. The broken lines represent the anode current and slope of the I.F. valve EAF 42 in the circuit of Fig. 2.

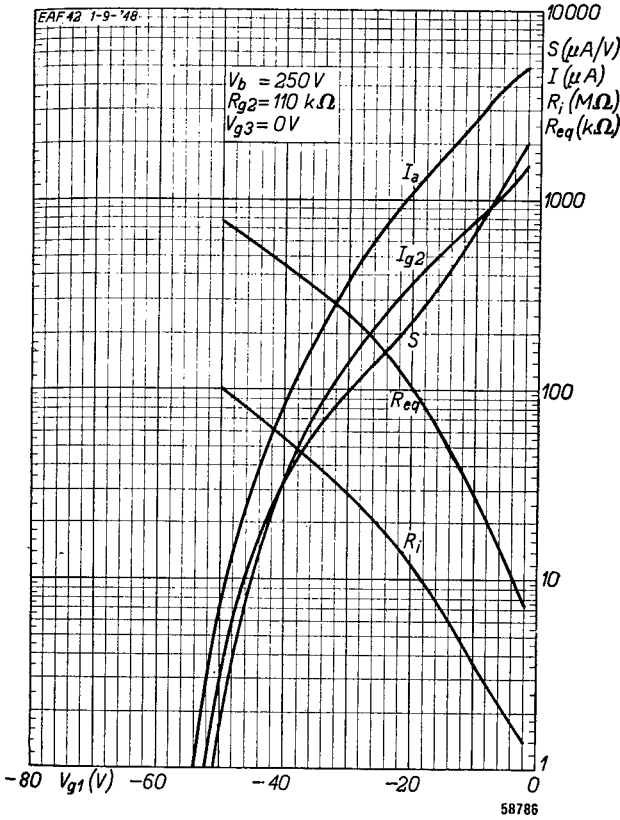
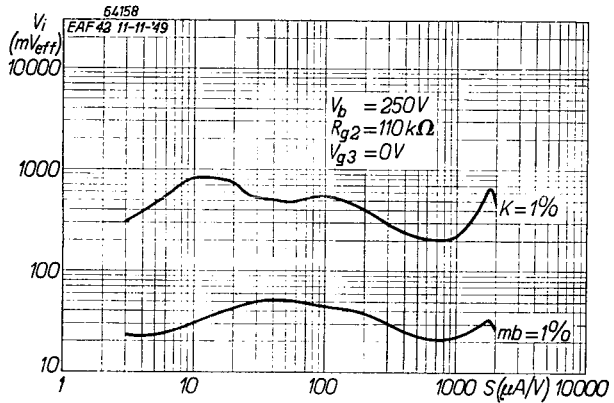

Fig. 14
Anode current (I_a), screen grid current (I_{g2}), mutual conductance (S), internal resistance (R_i) and equivalent resistance (R_{eq}) of the pentode section of the EAF 42 as functions of the grid bias, measured in the I.F. circuit shown in Fig. 2.

Fig. 15
R.M.S. voltage (V_i) of an interfering signal at the grid of the EAF 42, producing 1% cross modulation (curve $K = 1\%$), together with the R.M.S. value (V_i) of a hum voltage at the grid, resulting in 1% modulation hum (curve $m_b = 1\%$), measured as a function of the mutual conductance in the I.F. circuit shown in Fig. 2.



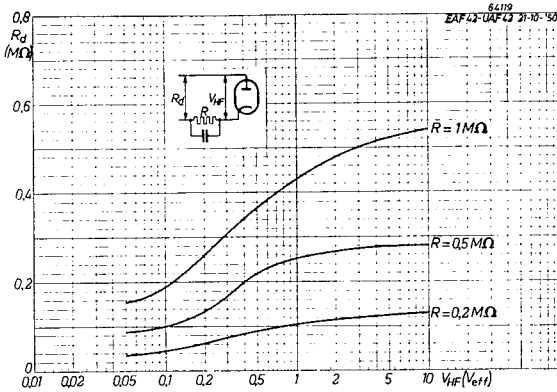

Fig. 16
Diode damping as a function of the applied R.F. voltage, for different values of the diode load resistance. This applies equally well to the diodes of the EAF 41 and the EAF 42.

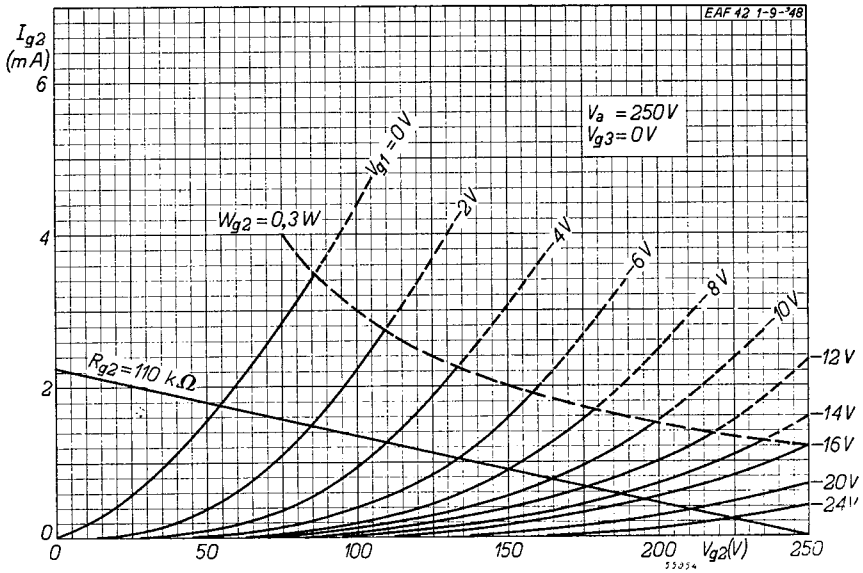

Fig. 17
Screen grid current (I_{g2}) of the pentode section of the EAF 42 as a function of the screen grid voltage (V_{g2}), with grid bias (V_{g1}) as parameter. The broken line indicates the maximum screen grid dissipation (0.3 W). The straight line refers to a series resistor of 110 k Ω in the screen grid circuit (see Fig. 2).

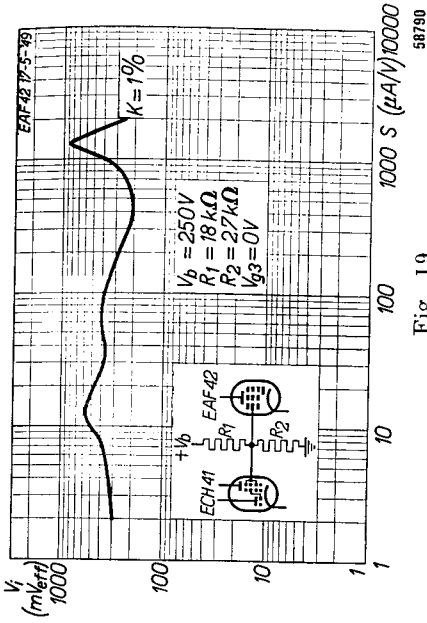

Fig. 19

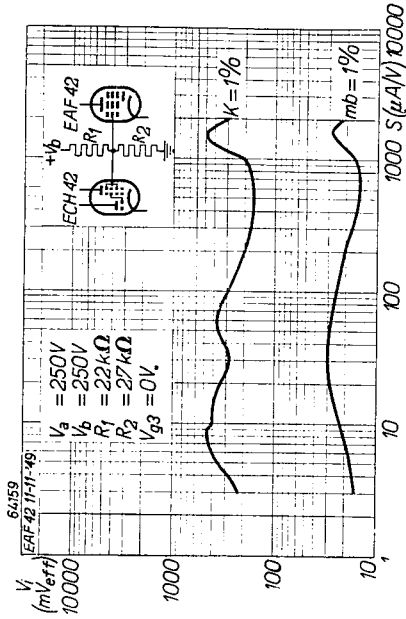

Fig. 20

As Fig. 15, The screen grids of the EAF 42 and frequency changer ECH 41 (Fig. 19) or ECH 42 (Fig. 20) are fed by means of a common potentiometer.

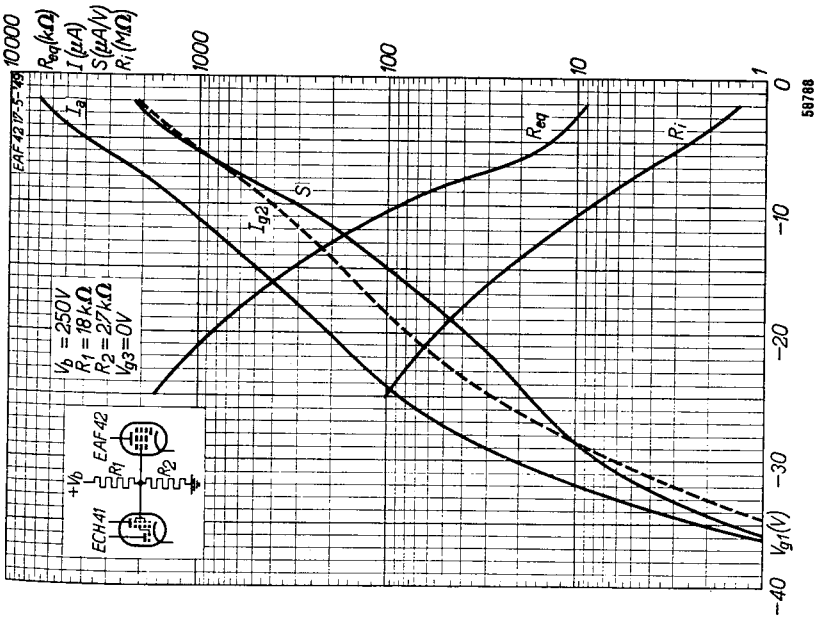

Fig. 18

As Fig. 14, In this case the screen grid voltage for the EAF 42 is derived from a potentiometer together with that of the ECH 41 (see Fig. 3).

EAF 42

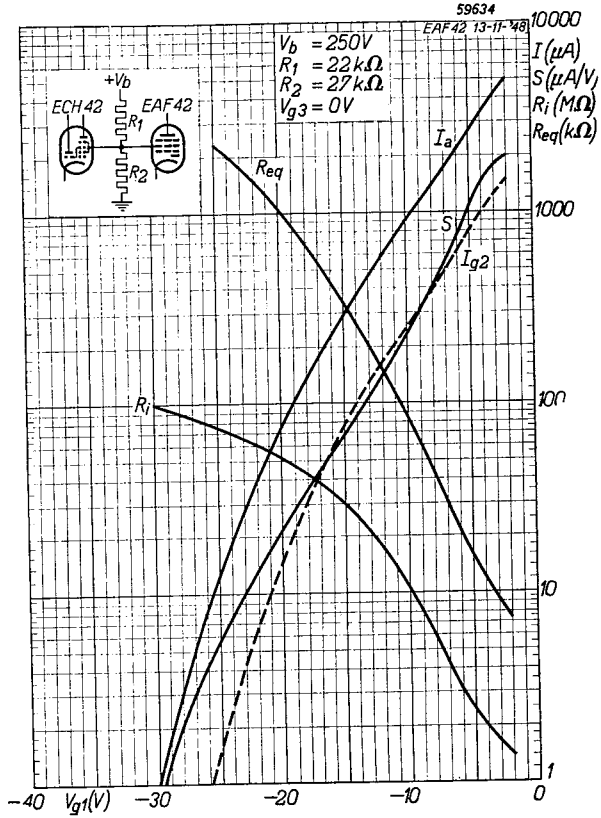

Fig. 21

As Fig. 14, but with the screen grids of the EAF 42 and frequency changer ECH 42 fed by means of a common potentiometer (see Fig. 3).

EB 41 Double diode

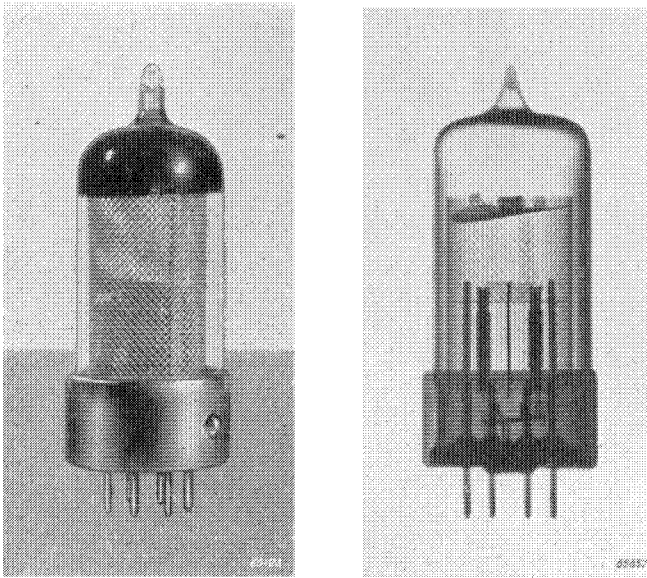

Fig. 1

Normal and X-ray photographs of the EB 41 (approximately actual size).

The EB 41 comprises two separate, indirectly heated diodes screened from each other; only the heaters are interconnected. The advantage of this design is that neither diode in any way affects the other, whilst the low inter-electrode capacitance and low internal resistance render this valve eminently suitable for television and F.M. receivers. For instance, to obtain a television picture with sufficient detail, it is essential that the highest modulation frequencies are not attenuated during detection of the signal; furthermore, to prevent picture distortion, the phase displacement of the detected voltages should be as nearly as possible proportional to the frequency. Both these conditions can be fulfilled if the detector loading resistance is kept low, which means that the internal resistance of the diode must also be low. The EB 41 is therefore an excellent valve for use in such detector circuits. If one diode of the EB 41 is used as detector in a television receiver, the other is still available for use as a so-called D.C. restorer. If the picture signal is detected and amplified in the normal manner, the brightness of the picture appearing on the C.R. tube is not at the correct brightness level. This can be rectified by means of a D.C. voltage, obtained by using the D.C. restorer diode to detect the I.F. signal.

In addition to these applications of the EB 41, it can be used as signal limiter and detector in F.M. receivers, whilst in ordinary broadcast receivers it will give better results than the conventional diodes.

EB 41

TECHNICAL DATA OF THE DOUBLE DIODE EB 41

Heater data

Heating : indirect, A.C. or D.C., series or parallel feed

Heater voltage	V_f	=	6.3 V
Heater current	I_f	=	0.3 A

Capacitances (cold valve)

Anode - cathode, first diode	C_{d1}	=	3.6 pF
Anode - cathode, second diode	C_{d2}	=	3.6 pF
Cathode - other electrodes, first diode	C_{k1}	=	4.5 pF
Cathode - other electrodes, second diode	C_{k2}	=	4.5 pF
Diode anode - diode anode	C_{d1d2}	<	0.03 pF

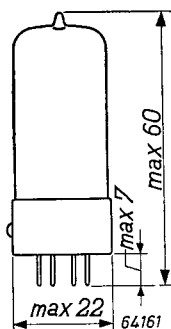
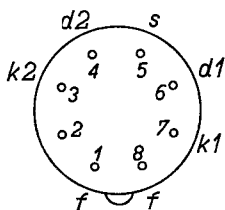
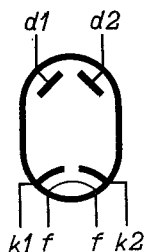

Fig. 2

Electrode arrangement, electrode connections and dimensions (in mm) of the EB 41.

Limiting values for use as half-wave rectifier (for each section)

Transformer voltage	V_{tr}	= max.	150 V_{RMS}
Output current	I_o	= max.	9 mA
Input capacitance of smoothing filter	C_{fnt}	= max.	8 μF
Total resistance in anode circuit	R_t	= min.	300 Ω
Voltage between heater and cathode	V_{fkp} (k pos., f neg.)	= max.	330 V ¹⁾

Limiting values (for each system)

Peak inverse voltage at the diode	$V_{d inv p}$	= max.	420 V
Diode current	I_d	= max.	9 mA
Peak diode current	I_{dp}	= max.	54 mA

¹⁾ Max. 200 V D.C. + max. 165 V A.C. (RMS-value).

Voltage between heater and cathode	V_{fk}	= max. 150 V
Voltage between heater and cathode (cathode positive with respect to heater)	V_{fkp} (k pos., f neg.)	= max. 330 V ¹⁾
External resistance between heater and cathode	R_{fk}	= max. 20 k Ω

¹⁾ Max. 200 V D.C. + max. 165 V A.C. (RMS-value).

Application of the EB 41 in television receivers

In Fig. 3 the diode D_1 is shown connected as a detector in a television receiver ; the load is provided by the resistor R_1 (approx. 4 k Ω), whilst C_1 is the detector capacitor (10 - 20 pF). The coil L_1 , connected in series with R_1 , works in conjunction with coil L_2 to compensate parasitic capacitances, thus making it possible to pass the necessary bandwidth to about 4 Mc/s. The diode D_2 functions as a D.C. restorer. Since the object in this case is to obtain a D.C. voltage, a high RC time constant is permissible. The load is formed by a potentiometer comprising resistors R_2 in parallel with capacitor C_2 , and R_3 in parallel with C_3 . The D.C. voltage across R_3 is applied through L_1 , R_1 and L_2 to the control grid of the next valve and so provides this valve with sufficient bias to ensure correct picture brightness.

In the arrangement shown in Fig. 3 the bias for the next valve is reduced ; if a more negative bias is required the anode and cathode connections of the EB 41 must be interchanged.

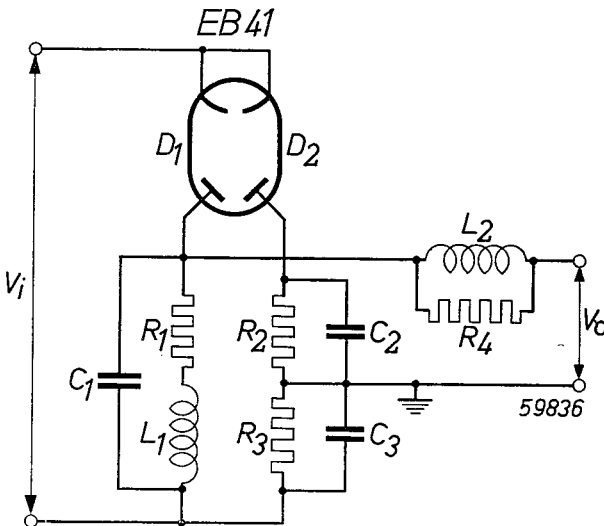

Fig. 3
The EB 41 used as detector diode and D.C. restorer in a television receiver.

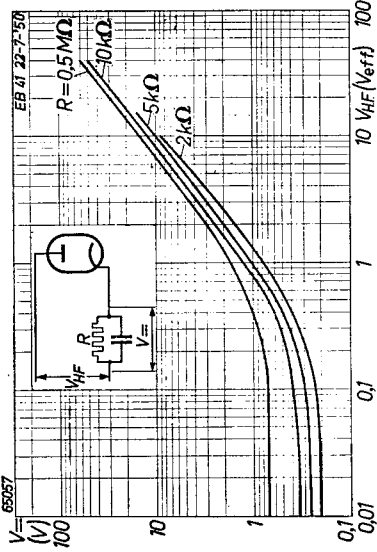

Fig. 5

The detected D.C. voltage (V) of each section of the EB 41, as a function of the H.F. input signal (V_{HF}) for various values of the load resistance (R).

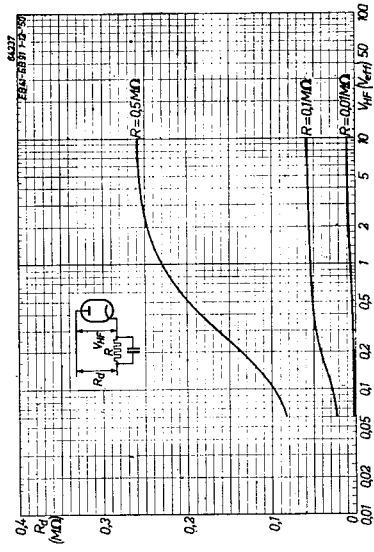

Fig. 6

Diode damping resistance (R_d), as a function of the H.F. input signal (V_{HF}) for various values of the diode load resistance (R).

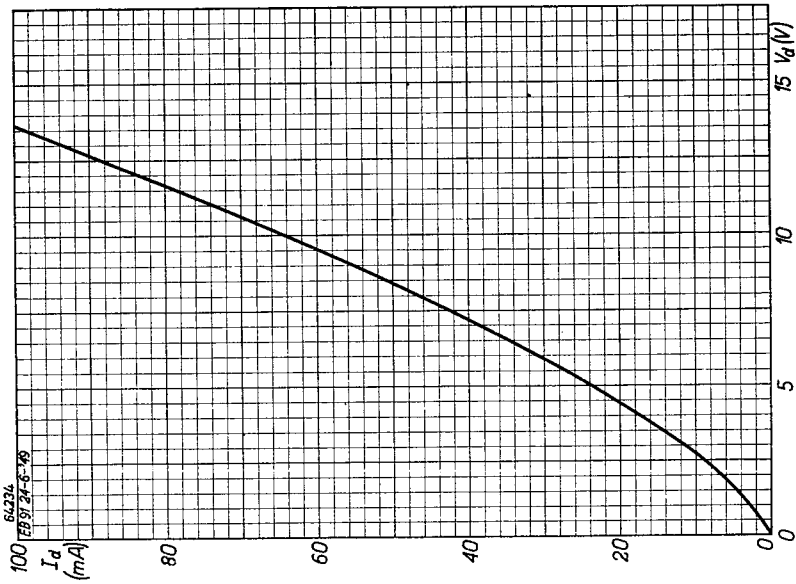

Fig. 4

The current I_d of each system of the EB 41, as a function of the voltage V_d .

EBC 41 Double diode-triode

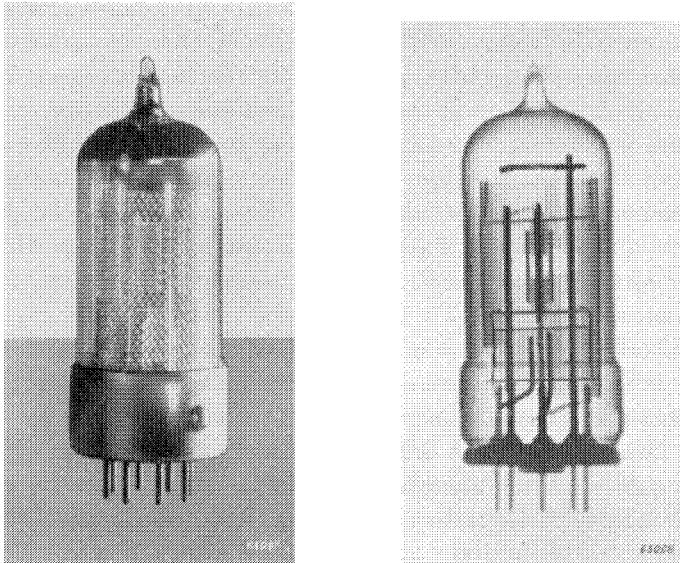

Fig. 1
Normal and X-ray photographs of the EBC 41 (approximately actual size).

The EBC 41 combines a triode with two diodes, having a common cathode ; the diodes can be used for detection and A.G.C., whilst the triode is suitable for A.F. amplification. Owing to the high amplification factor of the triode ($\mu=70$), an A.F. gain of about 50 is obtainable, with roughly 1% distortion. An A.F. gain of this value is rather higher than that generally required for ordinary broadcast receivers, and a certain gain reserve is therefore available to the set designer. This reserve can be utilized very effectively for feedback purposes, since the distortion introduced by the output stage can thus be considerably reduced.

To give an example, when the EL 41 is used as output valve, the EBC 41 should deliver 5.1 V to load fully the EL 41. If the gain of the EBC 41 is 20, the input voltage for this valve would have to be 0.26 V.

If it is intended to use the EBC 41 to furnish a higher gain than is normally required for broadcast receivers, it is essential to take into account that certain undesirable effects — such as hum and microphony — may be encountered, and that appropriate measures must then be taken. Naturally, the gain of the EBC 41 is not the only deciding factor ; the output stage following this valve is also important in this respect and must therefore be taken into account as well. Two factors determine the effect of the output stage on the microphony, namely the electrical gain from input to loudspeaker and the acoustic efficiency of the speaker. Here we are obviously dealing

EBC 41

with the total gain of both the A.F. stage and the output stage ; the amount contributed by each stage to the total gain being immaterial.

When the EBC 41 is used as an A.F. amplifier in conjunction with any particular output stage, the following rule is useful in ascertaining the extent to which the amplification can be increased without involving microphony. The actual value associated with this rule is mentioned in the description of the EAF 42, on page 34.

If the acoustic efficiency of the speaker is 5%, the EBC 41 can be used, without taking steps to prevent microphony, in circuits in which the alternating input voltage necessary to produce an output of 50 mW is not less than 10 mV. If this condition is satisfied, both the input signal and the volume can be increased without any risk of microphony. Assuming that microphony is caused by acoustic feedback from speaker to A.F. amplifier, it thus follows that the occurrence or absence of microphony is dependent only on the total A.F. amplification, and not on the presence of a strong or weak signal.

If the EL 41 be employed as an output valve, the EBC 41 — with the above-mentioned gain of 20 — must deliver 0.32 V to produce an output power of 50 mW ; this necessitates an input voltage of 16 mV, which, according to the foregoing remarks, is generally sufficient to prevent microphony.

Should a higher overall gain be required, it is usually necessary to take certain precautions, e.g. by placing the EBC 41 in an anti-microphonic valveholder, or by providing the valve with an acoustic screen.

In order to prevent undesirable hum voltages from reaching either the control grid or the detector diode (diode d_2), the arrangement and screening of the leads to the valveholder must be given careful attention. The internal capacitances between heater and control grid, and between heater and detector diode, are less than 0.05 pF, and any increase in these capacitances brought about by coupling in the wiring will naturally have an adverse effect on the amount of hum.

The gain for various resistance values is given in the table on page 61. In one of the circuits represented the biasing resistor is omitted, and a grid leak of 10 M Ω is recommended, this circuit being sometimes employed to save components, viz. the biasing resistor and the necessary de-coupling capacitor. The grid bias is then controlled by the grid current. A grid leak of not more than 22 M Ω may be used in this arrangement. A further condition to be observed is that, when a grid leak of such a high value is employed, the valve must not be biased in any other way, since traces of gas are always present in any valve; a flow of ions would otherwise be set up, which, in turn, would produce a voltage across the grid leak, opposed to the applied voltage. Moreover, owing to the fact that the actual quantities of residual gas in different valves vary considerably, the characteristics of the circuit would become very unstable. If the grid bias is obtained from a separate source, the grid leak should not exceed 3 M Ω , so that the variations in question may be kept within reasonable bounds.

In order to avoid hum when a large grid leak is used, it is most important to ensure that the hum voltage impedance in the grid circuit is as low as possible. To this end, a capacitor whose impedance will ensure this should

be connected in parallel with the grid leak. Usually, the coupling capacitor for the detector circuit, in series with the volume control, is sufficient for this purpose.

Of the two diodes in the EBC 41, that which is marked d_2 in the diagram is the most suitable for detection, since the capacitance of this diode with respect to the heater is lower than that of the other; the hum voltage is thus also lower.

As already mentioned, it is essential so to arrange the diode and heater leads as to reduce the capacitance between them to a minimum.

Diode d_1 can be used for A.G.C. In view of the fact that this diode is usually connected to the primary of the second I.F. transformer, and the detector diode to the secondary, the capacitance between these diodes and their leads must also be kept as low as possible, to avoid excessive capacitive coupling between the two circuits.

In order to limit as much as possible the effect on the triode section of the A.C. voltages in the diode section, a screen is provided in the envelope between the two sections. Another screen is fitted round the whole of the system, to shield the valve systems from external influences.

TECHNICAL DATA OF THE DOUBLE DIODE-TRIODE EBC 41

Heater data

Heating : indirect, A.C. or D.C., parallel feed		
Heater voltage	V_f	= 6.3 V
Heater current	I_f	= 0.23 A

Capacitances (cold valve)

a) *Triode section*

Input capacitance	C_g	= 2.5 pF
Output capacitance	C_a	= 1.7 pF
Anode - grid	C_{ag}	= 1.5 pF
Heater - grid	C_{gf}	< 0.05 pF

b) *Diode section*

Input capacitance, diode 1	C_{d1}	= 0.8 pF
Input capacitance, diode 2	C_{d2}	= 0.7 pF
Between the two diodes	C_{d1d2}	< 0.3 pF
Diode 1 - heater	C_{d1f}	< 0.1 pF
Diode 2 - heater	C_{d2f}	< 0.05 pF

c) *Between diode and triode sections*

Between grid and diode 1	C_{gd1}	< 0.007 pF
Between grid and diode 2	C_{gd2}	< 0.03 pF
Between anode and diode 1	C_{ad1}	< 0.01 pF
Between anode and diode 2	C_{ad2}	< 0.01 pF

EBC 41

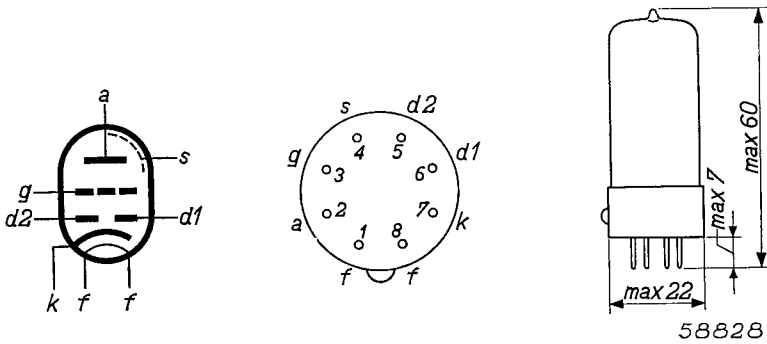

Fig. 2

Electrode arrangement, electrode connections and maximum dimensions of the EBC 41 (dimensions in mm).

Typical characteristics (see Figs. 4 and 5)

Anode voltage	V_a	=	250 V
Grid voltage	V_g	=	-3 V
Anode current	I_a	=	1.0 mA
Slope	S	=	1.2 mA/V
Amplification factor	μ	=	70
Internal resistance	R_i	=	58 k Ω

Operating characteristics of the triode system as A.F. amplifier

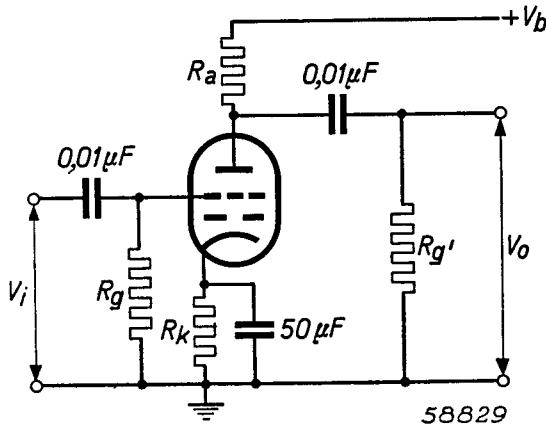

Fig. 3

The EBC 41 used as A.F. amplifier with resistance coupling. R'_g represents the grid leak of the next valve.

For particulars concerning microphony, see page 57.
 Supply voltage $V_b=250$ V.

Anode resistor R_a (M Ω)	Cathode resistor R_k (k Ω)	Grid resistor R_g (M Ω)	Grid resistor of output valve R'_g (M Ω)	Anode current I_a (mA)	Amplification V_o/V_i	Distortion d_{tot} (%) with output voltage \bar{V}_o of	
						5 V _{RMS}	10V _{RMS}
0.22	1.8	1	0.68	0.70	51	0.55	0.9
0.1	1.2	1	0.33	1.15	43	0.6	1.1
0.22	0	10	0.68	0.76	52	0.5	0.75
0.1	0	10	0.33	1.40	44	0.7	0.9

Limiting values of the triode system

Anode voltage, valve biased to cut-off	V_{a_o}	= max. 550 V
Anode voltage	V_a	= max. 300 V
Anode dissipation	W_a	= max. 0.5 W
Cathode current	I_k	= max. 5 mA
Grid current starting point	$V_g(I_g=+0.3\mu A)$	= max. -1.3 V
External resistance between grid and cathode	R_g	= max. 3 M Ω ¹⁾
External resistance between heater and cathode	R_{fk}	= max. 20 k Ω
Voltage between heater and cathode	V_{fk}	= max. 100 V

Limiting values of the diode system

Peak inverse voltage both anodes	$V_{d\ inv\ p}$	= max. 350 V
Current flowing to each anode	I_a	= max. 0.8 mA
Peak current flowing to each anode	I_{ap}	= max. 5 mA
Diode current starting point	$V_a(I_a=+0.3\mu A)$	= max. -1.3 V
External resistance between heater and cathode	R_{fk}	= max. 20 k Ω
Voltage between heater and cathode	V_{fk}	= max. 100 V

¹⁾ The value of 3 M Ω is applicable only if the grid bias is obtained from a biasing resistor in the cathode lead. If the grid bias is derived only from a resistor in the grid circuit, the maximum value for R_g is 22 M Ω .

EBC 41

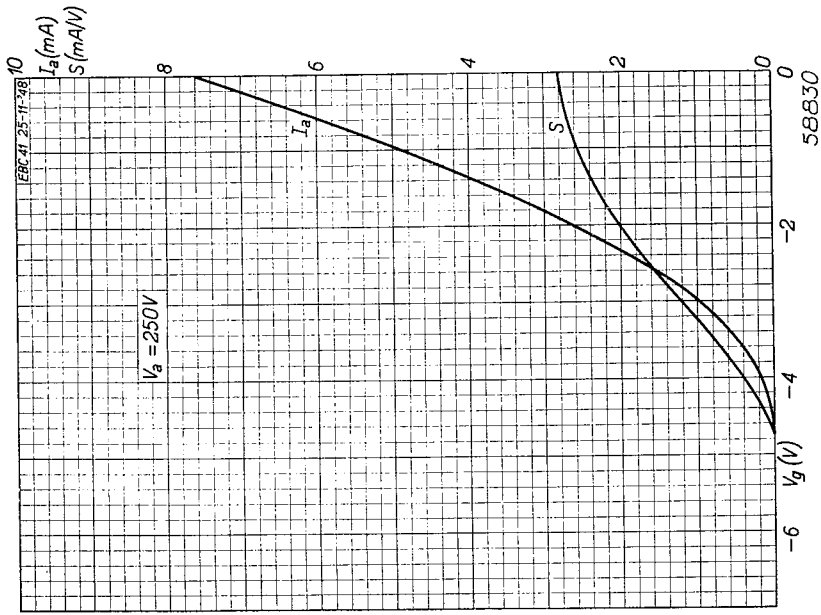

Fig. 4
 I_a/V_g and S/V_g characteristics of the EBC 41
 for an anode voltage of 250 V.

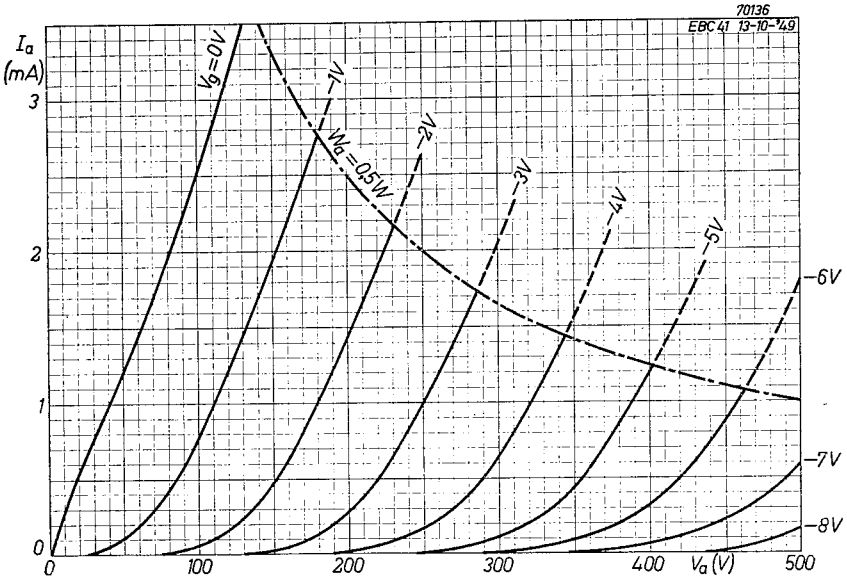

Fig. 5
 I_a/V_a characteristics of the EBC 41 for different
 values of the grid bias V_g . The dotted line
 indicates the maximum permissible anode
 dissipation.

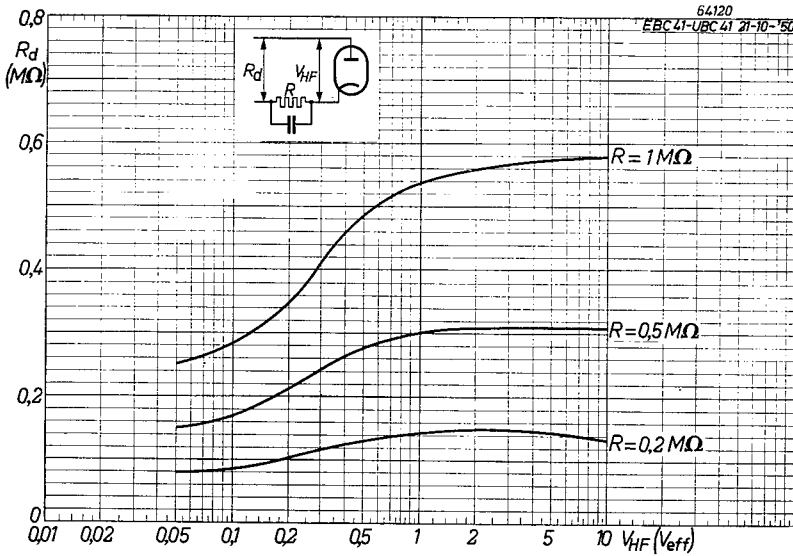

Fig. 6
Diode damping resistance as a function of the R.F. input signal for different values of the diode load resistance.

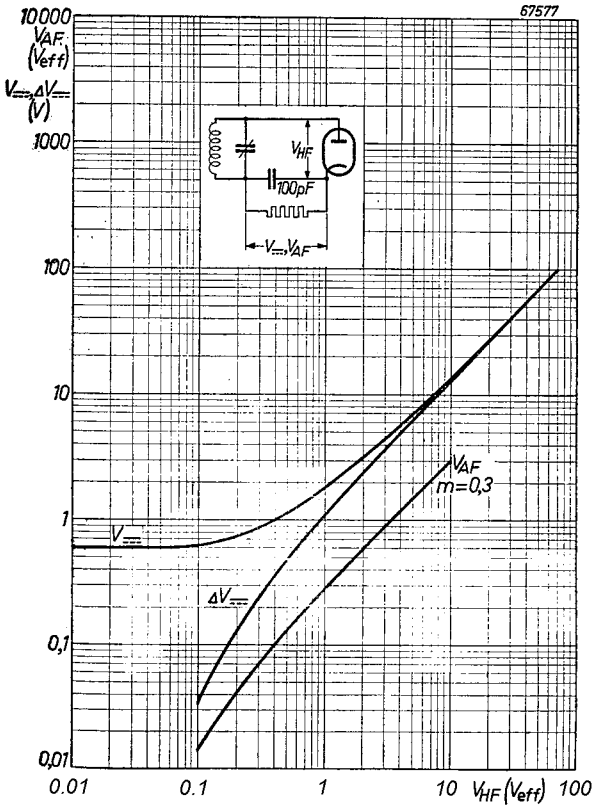

Fig. 7
The D.C. voltage $V =$ and the increase in the D.C. voltage $\Delta V =$ across the resistor in the diode circuit, as a function of the unmodulated R.F. voltage (V_{HF}) on a diode of the EBC 41. Also the A.F. voltage (V_{AF}) across this resistor, as a function of the R.F. voltage modulated to 30% (V_{AF} ; $m = 0.3$). These characteristics are applicable with resistors of 0.1 to 1 $M\Omega$.

ECH 41

ECH 41 Triode-hexode frequency changer

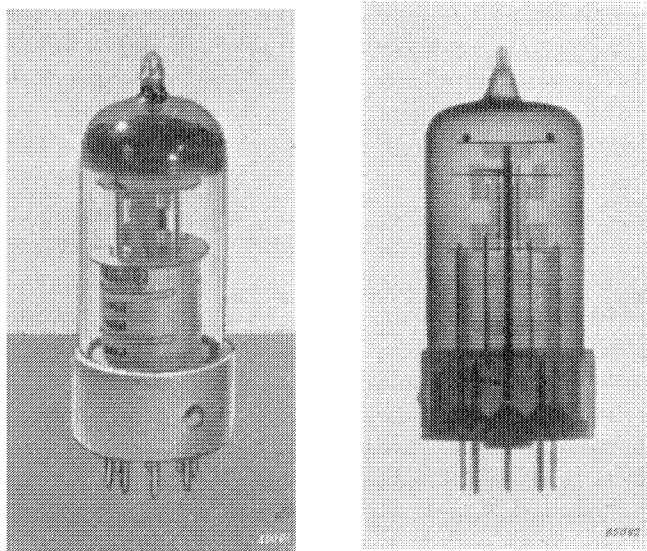

Fig. 1

Normal and X-ray photographs of the ECH 41 (approximately actual size).

The ECH 41 is a triode-hexode designed along the simplest possible lines, whilst retaining the best possible mixing properties. As the grid of the triode system and the modulator (third) grid of the hexode system are internally connected, the valve can be used as frequency changer only.

The conversion conductance of this valve is variable, being $500 \mu\text{A}/\text{V}$ at the working point, for an oscillator voltage of $8 V_{\text{RMS}}$. From Fig. 12 it will be seen that the conversion conductance varies only slightly with the oscillator voltage. Since the internal resistance of the valve is $2 \text{ M}\Omega$ at the working point, the anode can be connected to the "top" of the first I.F. transformer. Using I.F. transformer circuits with coils having a quality factor of $Q=140$ and critical coupling, with tuning capacitors of 100 pF , a conversion gain of about 90 is obtainable.

The initial slope of the triode section (i.e. the slope of the valve when not oscillating) (at $V_o=0$) is $1.9 \text{ mA}/\text{V}$; the effective slope of the oscillating valve is $0.55 \text{ mA}/\text{V}$, with an oscillator voltage of $8 V_{\text{RMS}}$ (the effective slope is the quotient of the fundamental components of alternating anode current and alternating grid voltage). Although the initial slope is of a sufficiently high value to start the oscillation under normal circumstances, and the effective slope more than enough to maintain oscillation, it is advisable to use an extra coil in the short-wave band. Further reference is made to this point later.

Fig. 2 shows the ECH 41 used as frequency changer for medium and long wavelengths. To ensure that the very satisfactory internal resistance of the valve is retained when control is applied, the screen grids of the hexode system should be fed from a potentiometer, and a good arrangement consists in connecting a resistor of 33 kΩ between the supply voltage and the screen grids, with 47 kΩ between screen grids

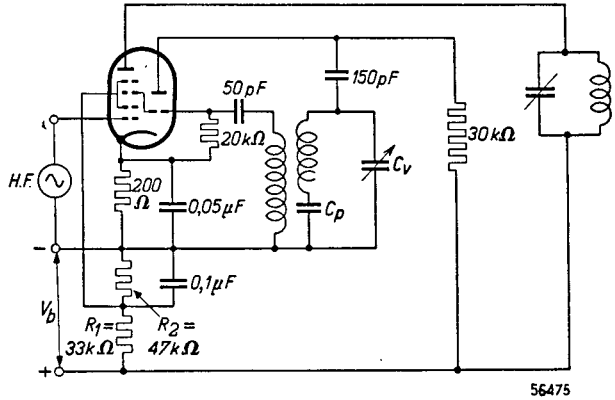

Fig. 2
The ECH 41 used as frequency changer in a conventional type of circuit.

and chassis. When the EAF 42, or EF 41 is used as I.F. amplifier, the screen grid voltage for this valve can be derived from the same potentiometer, thus saving a resistor and a decoupling capacitor. The recommended resistance values for this potentiometer are then $R_1 = 18\text{ k}\Omega$ and $R_2 = 27\text{ k}\Omega$. To prevent squegging at the short-wave ends of the wave-bands, it is advisable to limit the oscillator grid leak to 20 kΩ and the capacitance between grid and feedback coil to about 50 pF; these values, however, should also be regarded as minima, since a further reduction would unnecessarily impair the characteristics of the circuit.

In order to minimize frequency drift due to mains voltage fluctuations and the action of A.G.C., the tuned circuit is incorporated in the anode circuit of the triode; parallel feed is then employed to ensure that no D.C. voltage will reach the variable capacitor. This also tends to produce a constant oscillator voltage over the entire wave-band. The recommended value for the parallel resistor is about 30 kΩ.

An even more constant oscillator voltage is ensured throughout the whole wave-band if the lower end of the feedback coil is connected to the padding capacitor (Fig 3). By this means an inductive coupling is combined with a capacitive coupling as in the Colpitts oscillator; at the lower values of the tuning capacitor the inductive feedback predominates, at high values the capacitive coupling. The two types of coupling therefore supplement each other and the oscillator voltage remains prac-

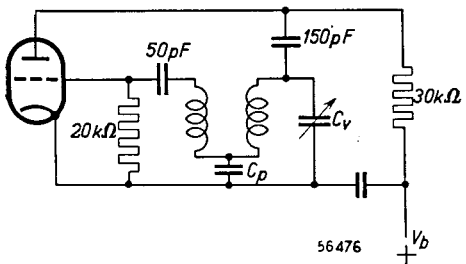

Fig. 3
Oscillator circuit with feedback coil connected to the padding capacitor to secure an oscillator voltage that will vary but little over the whole of the wave-band.

ECH 41

tically constant throughout the wave-band.

In view of the fact that the impedance of the oscillator circuit is lowest on short waves, this circuit should be given careful consideration in the case of short-wave reception. To ensure a satisfactory oscillator voltage, the coupling of the coil system should be made fairly tight

$$(t = \frac{\text{alternating grid voltage}}{\text{alternating anode voltage}} = \text{approx. } 0.5).$$

This naturally has the disadvantage of more pronounced frequency drift when gain control is applied and a greater likelihood of squegging, particularly at the short wavelengths of the wave-band. These difficulties are overcome in the circuit shown in Fig. 4, which employs less feedback (e.g. $t=0.35$) but an extra coil, L_2 , between grid capacitor and feedback coil.

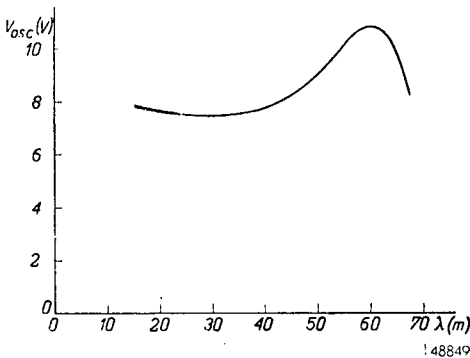

Fig. 5

Variations in the oscillator voltage as a function of the wavelength, relative to the circuit shown in Fig. 4.

roughly 1 kc/s, even at the lower end of the short-wave range. Furthermore, as a result of the looser coupling between oscillator circuit and feedback coil, the effects of the parallel capacitance of the grid circuit are not transmitted to the tuned circuit to the same extent. This results in a wider frequency range, which is usually desirable on the short-wave band. Particulars of practical interest concerning the extra coil will be found in the description of circuit I, on page 123.

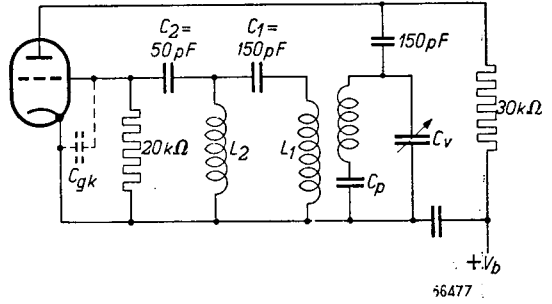

Fig. 4

Oscillator circuit for short waves. An extra coil, L_2 , is introduced between grid capacitor and feedback coil, thus increasing the oscillator voltage at the upper end of the wave-band.

The oscillator voltage induced in the feedback coil L_1 is here divided between the isolating capacitor C_1 and the coils L_1 and L_2 , and an oscillator voltage gain is obtained at the resonant frequency. Coil L_2 is so proportioned that this resonant frequency occurs outside the wave-band, say at $\lambda=60$ m. The reduced inductive coupling at 50 m is then supplemented by the voltage gain across L_2 , producing a voltage which varies as a function of the wavelength in the manner depicted in Fig. 5.

By using the extra coil, the risk of squegging is completely eliminated, and the frequency drift caused by the gain control is restricted to

TECHNICAL DATA OF THE TRIODE-HEXODE ECH 41

Heater data

Heating : indirect, A.C. or D.C., parallel feed

Heater voltage	V_f	=	6.3 V
Heater current	I_f	=	0.23 A

Capacitances (cold valve)

Hexode section

Input	C_{g1}	=	3.4 pF
Output	C_a	=	6.0 pF
Anode - control grid	C_{ag1}	<	0.1 pF
Control grid - heater	C_{g1f}	<	0.15 pF

Triode section

Input	$C_{(gT+g3)}$	=	4.8 pF
Output	C_a	=	1.5 pF
Anode - grid	$C_{a(gT+g3)}$	=	1.2 pF

Between triode and hexode sections

Between control grids	$C_{(gT+g3)-g1H}$	<	0.35 pF
Hexode anode - triode grid	$C_{(gT+g3)-aH}$	<	0.2 pF

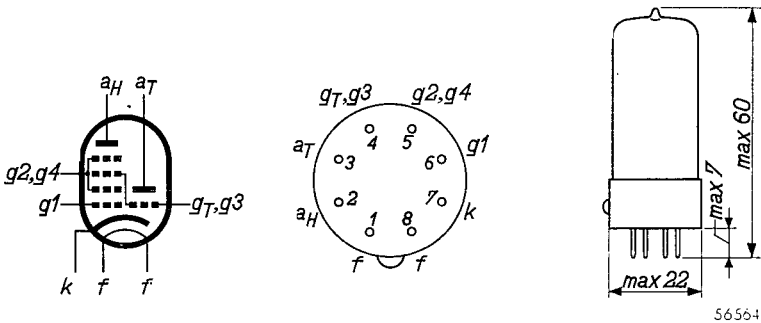

Fig. 6
Electrode arrangement, electrode connections and maximum dimensions in mm of the ECH 41.

ECH 41

Operating characteristics of the hexode section used as mixer (see Figs. 2 and 9 to 12 inclusive)

Anode and supply voltage	$V_{aH}=V_b$	=	250	V
Resistor between supply voltage and screen grids	R_1	=	33	k Ω
Resistor between screen grids and chassis	R_2	=	47	k Ω
Biasing resistor	R_k	=	200	Ω
Oscillator grid leak	$R_{(gT+g3)}$	=	20	k Ω
Oscillator grid current	$I_{(gT+g3)}$	=	350	μ A
Grid bias	V_{g1}	=	$\overbrace{-2 \quad -28}$	V
Screen grid voltage	$V_{(g2+g4)}$	=	105	147 V
Anode current	I_{aH}	=	3.0	— mA
Screen grid current	$I_{(g2+g4)}$	=	2.2	— mA
Conversion conductance	S_c	=	500	5 μ A/V
Internal resistance	R_i	=	2.0	>5 M Ω
Equivalent noise resistance	R_{eq}	=	170	— k Ω

Operating characteristics of the triode section used as oscillator (see Figs. 2 and 16)

Supply voltage	V_b	=	250	V
Anode resistor	R_a	=	30	k Ω
Grid leak	$R_{(gT+g3)}$	=	20	k Ω
Anode current	I_a	=	4.9	mA
Grid current	$I_{(gT+g3)}$	=	350	μ A
Oscillator voltage	V_{osc}	=	8	V_{RMS}
Effective slope	S_{eff}	=	0.55	mA/V

Typical characteristics of the triode section (see Figs. 14 and 15)

Anode voltage	V_a	=	100	V
Grid bias	V_g	=	0	V
Anode current	I_a	=	8.5	mA
Slope	S	=	1.9	mA/V
Amplification factor	μ	=	19	

Operating characteristics of the ECH 41 used as phase inverter

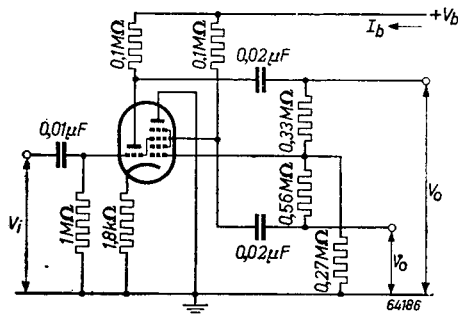

Fig. 7

Supply voltage V_b (V)	Total current I_b (mA)	Amplification V_o/V_i	Distortion (%) at an output voltage of		
			5 V_{RMS}	10 V_{RMS}	15 V_{RMS}
250	3.0	10	0.8	1.3	1.8
350	4.2	10	0.7	1.2	1.6

Operating characteristics of the hexode section used as frequency changer, with screen grids of ECH 41 and I.F. amplifier EAF 42 fed by means of a common potentiometer (see Fig. 17)

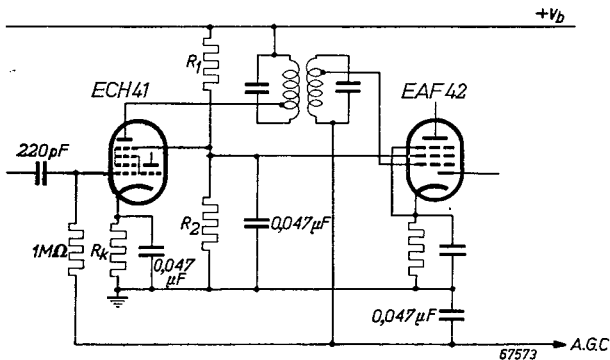

Fig. 8

ECH 41

Anode and supply voltage	$V_{aH} = V_b$	=	250	V
Potentiometer for screen grid feed (see Fig. 8)	$\left\{ \begin{array}{l} R_1 \\ R_2 \end{array} \right.$	=	18	k Ω
Biasing resistor	R_k	=	27	k Ω
Oscillator grid leak	$R_{(gT+g3)}$	=	200	Ω
Oscillator grid current	$I_{(gT+g3)}$	=	20	k Ω
		=	350	μ A
Grid bias	V_{g1}	=	$\overbrace{-2 \quad -23.5}$	V
Screen grid voltage	$V_{(g2+g4)}$	=	105	147
Anode current	I_{aH}	=	3.0	— mA
Screen grid current	$I_{(g2+g4)}$	=	2.2	— mA
Conversion conductance	S_c	=	500	10 μ A/V
Internal resistance	R_i	=	2.0	>5 M Ω
Equivalent noise resistance	R_{eq}	=	170	— k Ω

Limiting values of the hexode section

Anode voltage, valve biased to cut-off	V_{a_o}	= max.	550	V
Anode voltage	V_a	= max.	300	V
Anode dissipation	W_a	= max.	0.8	W
Screen grid voltage, valve biased to cut-off	$V_{(g2+g4)_o}$	= max.	550	V
Screen grid voltage	$V_{(g2+g4)}$	= max.	125	V
Screen grid dissipation	$W_{(g2+g4)}$	= max.	0.3	W
Grid current starting point	$V_{g1}(I_{g1} = + 0.3 \mu A)$	= max.	-1.3	V
Cathode current	I_k	= max.	7	mA
External resistance between cathode and control grid	R_{g1}	= max.	3	M Ω
External resistance between cathode and third grid	R_{g3}	= max.	3	M Ω
External resistance between cathode and heater	R_{fk}	= max.	20	k Ω
Voltage between cathode and heater	V_{fk}	= max.	100	V

Limiting values of the triode section

Anode voltage, valve biased to cut-off	V_{a_o}	= max.	550	V
Anode voltage	V_a	= max.	175	V
Anode dissipation	W_a	= max.	0.9	W
Grid current starting point	$V_g(I_g = + 0.3 \mu A)$	= max.	-1.3	V
Cathode current	I_k	= max.	5.5	mA
External resistance between cathode and grid	R_g	= max.	3	M Ω
External resistance between cathode and heater	R_{fk}	= max.	20	k Ω
Voltage between cathode and heater	V_{fk}	= max.	100	V

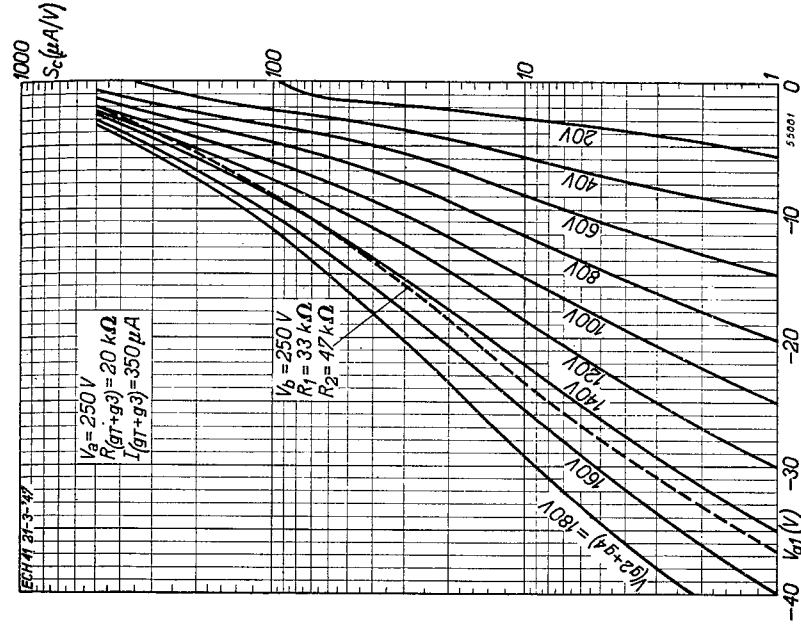

Fig. 10

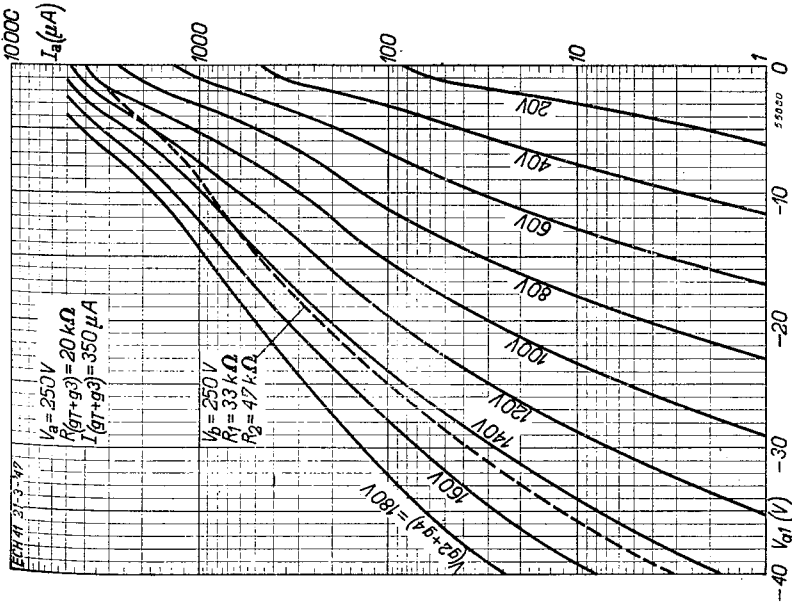

Fig. 9

Anode current I_a (Fig. 9) and conversion conductance S_c (Fig. 10) as functions of the grid bias V_{g1} for various values of the screen grid voltage $V_{(g2+g4)}$, with oscillator voltage of 8 V RMS on third grid producing a direct current $I_{(g1+g3)}$ of 350 μA through the grid leak $R_{(g1+g3)}$ of 20 k Ω . The dotted lines indicate the I_a (Fig. 9) and S_c (Fig. 10) when $V_{(g2+g4)}$ is derived from a potentiometer R_1, R_2 connected between the supply voltage and chassis (see Fig. 2).

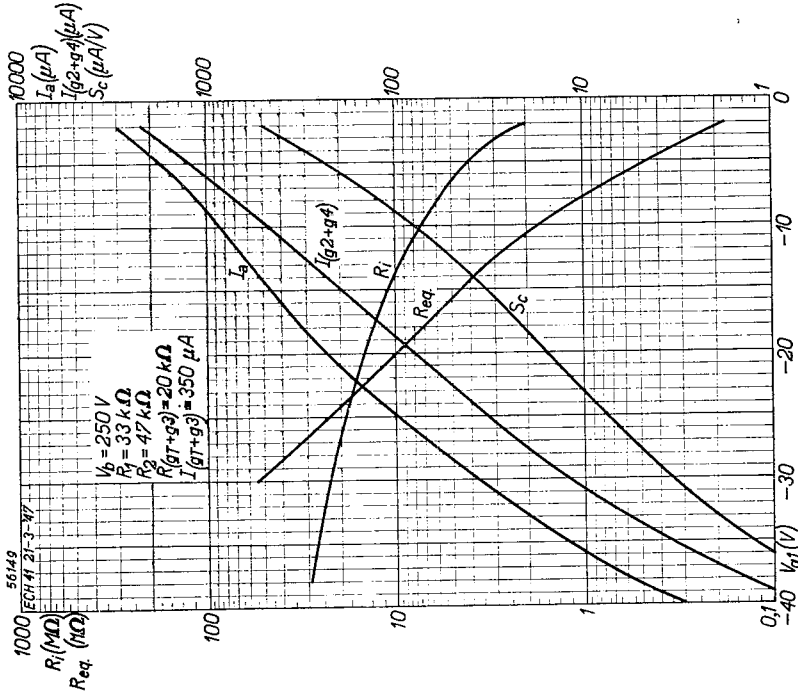

Fig. 11

Anode current I_a , screen grid current $I_{(g_2+g_4)}$, conversion conductance S_c , internal resistance R_i , and equivalent noise resistance R_{eq} of the hexode section as functions of the grid bias V_{g1} . The oscillator voltage on the third grid = 8V_{RMS} and the screen grid voltage is derived from a potentiometer R_1, R_2 (see Fig. 2).

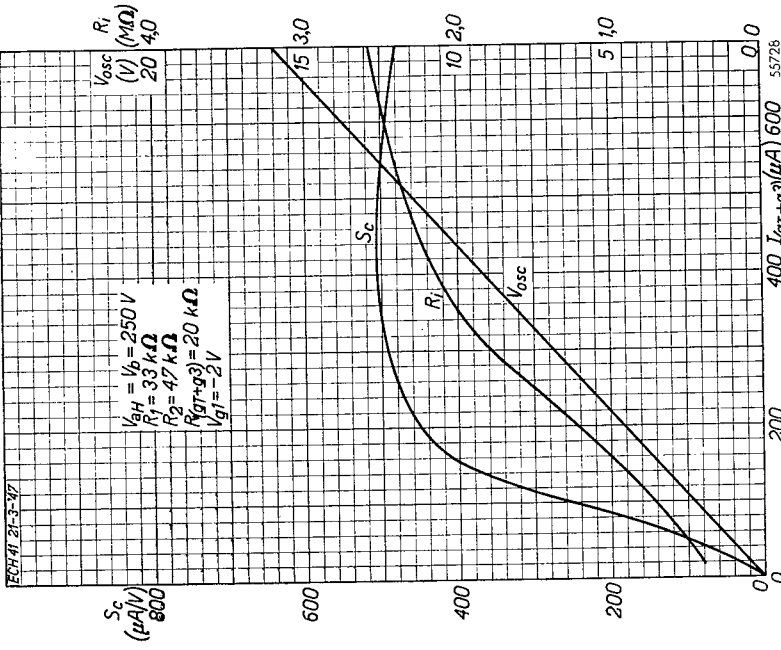

Fig. 12

Conversion conductance S_c , internal resistance R_i , and oscillator voltage V_{osc} of the hexode section as functions of the oscillator grid current $I_{(g_1+g_3)}$ with grid bias $V_{g1} = -2 V$ and oscillator grid leak $R_{(g_1+g_3)} = 20 k\Omega$. Screen grid voltage obtained from a potentiometer R_1, R_2 (see Fig. 2).

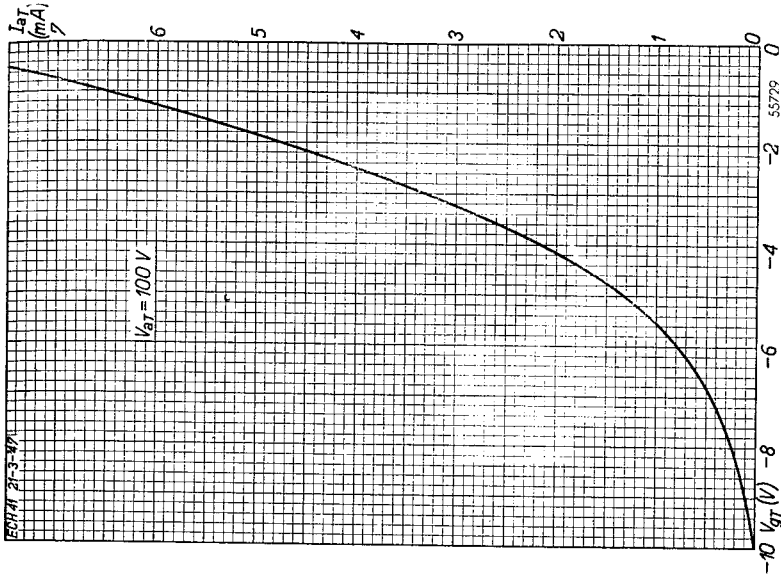

Fig. 14 Anode current I_{aT} of the triode section, as a function of the triode grid voltage V_{gT} , at an anode voltage $V_{aT} = 100 \text{ V}$ (static characteristic).

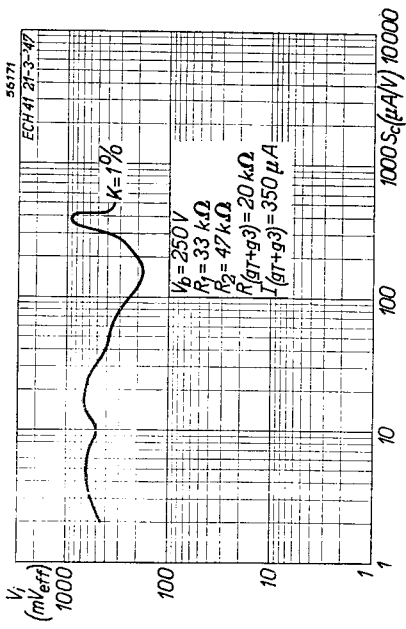

Fig. 13 Effective voltage V_i of an interfering signal on the control grid of the hexode section and producing 1% cross-modulation, as a function of the conversion conductance S_c . Oscillator voltage on third grid = $8V_{RMS}$, screen grid voltage derived from a potentiometer R_1, R_2 (see Fig. 2).

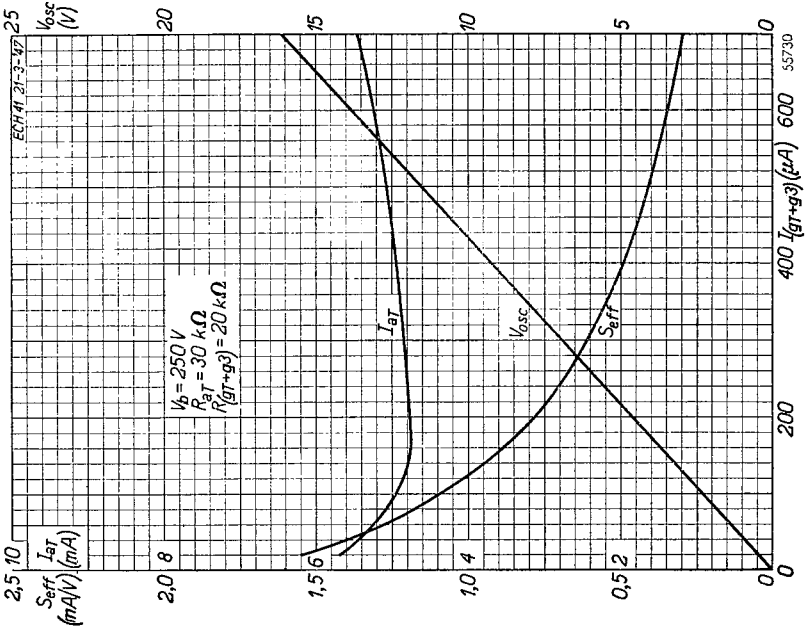

Fig. 16
Anode current I_{aT} , oscillator voltage V_{osc} and effective slope S_{eff} of oscillating triode, as a function of the oscillator grid current $I_{(gT+g3)}$. For circuit diagram see Fig. 2.

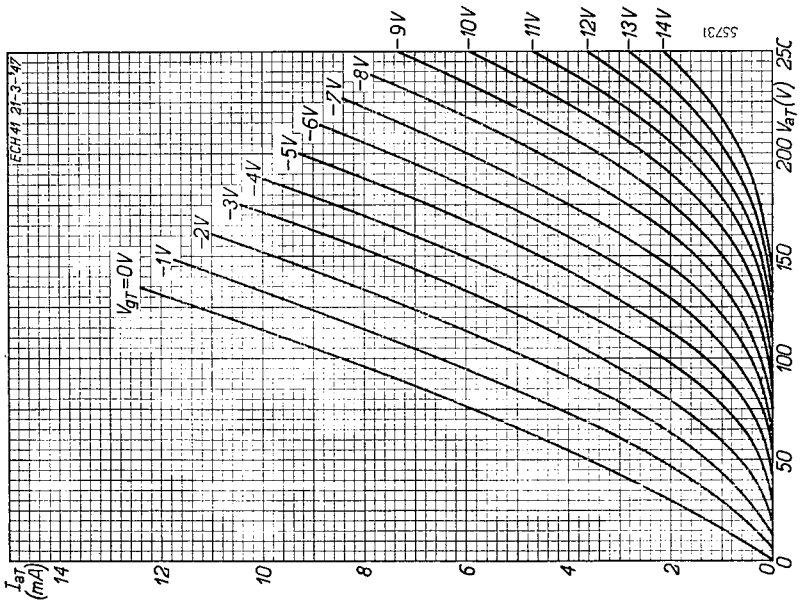

Fig. 15
Anode current I_{aT} of the triode section, as a function of the triode anode voltage V_{aT} , at various values of the grid bias V_{gT} (static characteristic-).

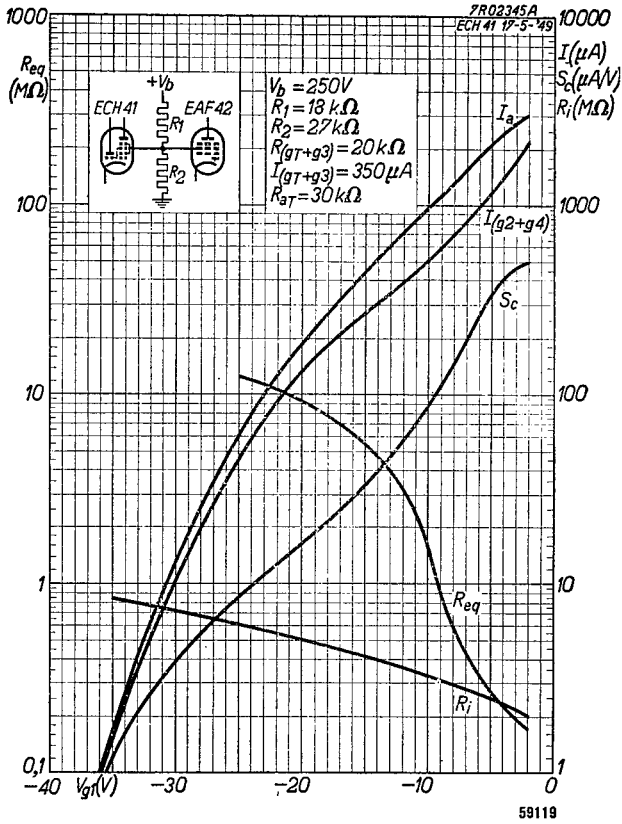

Fig. 17
As Fig. 11, but with screen voltage of the ECH 41, together with that of the R.F. or I.F. amplifier EAF 42 derived from a common potentiometer.

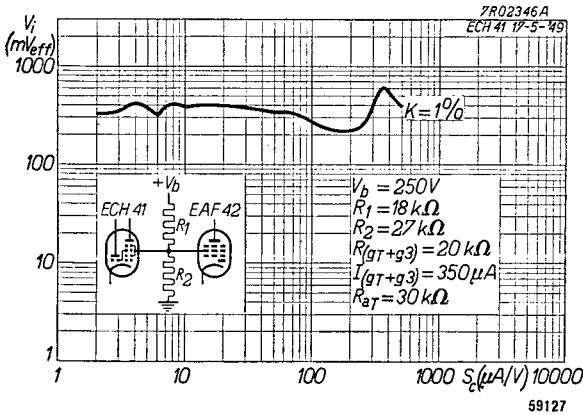

Fig. 18
As Fig. 13, but with the screen grids of the ECH 41 and EAF 42 fed by means of a common potentiometer.

ECH 42

ECH 42 Triode-hexode frequency changer

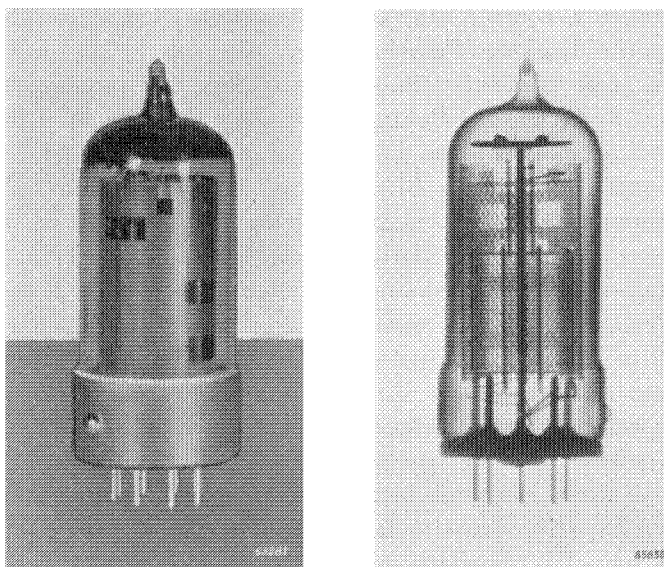

Fig. 1

Normal and X-ray photographs of the ECH 42 (approximately actual size).

The ECH 42 is a frequency changer which, like the ECH 41, is designed as a triode hexode, but various features, including a screen fitted round the entire system, have so improved the design that the properties of the ECH 42 are much superior to those of the ECH 41. The conversion slope of the ECH 42 is variable, being $750 \mu\text{A}/\text{V}$ at the working point.

The third grid of the hexode section and the grid of the triode section are internally connected, as in the earlier model; hence this valve is also unsuitable for combined A.F. and I.F. amplification.

On the other hand, the ECH 42 can be employed as a combined A.F. amplifier-phase inverter, the triode system being then connected as the A.F. amplifier and the hexode system as the phase inverter. In view of the fact that the third grid of the hexode is connected to the grid of the triode, the voltage on the former will counteract the gain in the hexode, but, since no amplification is required in this case, the efficiency of the valve is not thereby adversely affected.

The initial slope of the triode system, i.e. the slope without oscillator voltage or grid bias, is $2.8 \text{ mA}/\text{V}$, so that, from the point of view of oscillatory properties, this valve is better than the ECH 41, the improvement being particularly noticeable on the short-wave range.

Frequency displacement attributable to gain control or mains fluctuations is so slight, even at the shortest wavelengths in the short-wave range, that

it may be disregarded ; moreover, the hexode principle ensures that induction effects are so small that they have no effect on the conversion gain.

As with the ECH 41, the screen grids must be fed by means of a potentiometer ; if a series resistor is employed, the screen voltage rises as soon as control is applied, resulting in secondary emission and a pronounced drop in internal resistance. With low internal resistance, the conversion gain decreases, but this is not generally detrimental, since the valve is controlled for the very purpose of reducing the gain ; however, another result of low internal resistance is that the I.F. transformer in the anode circuit of the hexode is heavily damped, to the detriment of the selectivity. In general, then, the use of a series resistor feed is not recommended.

If the EF 41, or EAF 42, is used as I.F. amplifier in conjunction with the ECH 42 as frequency changer, it is possible to feed the screen grids of both valves by means of a common potentiometer, resulting in a saving of various components.

TECHNICAL DATA OF THE TRIODE-HEXODE ECH 42

Heater data

Heating : indirect, A.C. or D.C., parallel feed

Heater voltage	V_f	=	6.3 V
Heater current	I_f	=	0.23 A

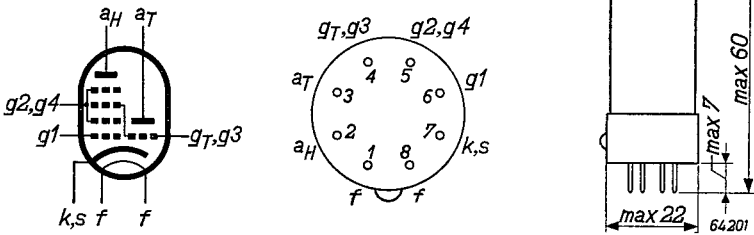

Fig. 2

Electrode arrangement, electrode connections and dimensions (in mm) of the ECH 42.

Capacitances (cold valve)

Hexode section

Input capacitance	C_{g1}	=	4.0 pF
Output capacitance	C_a	=	9.4 pF
Anode - control grid	C_{ag1}	<	0.1 pF
Control grid - heater	C_{gf}	>	0.15 pF

Triode section

Input capacitance	$C_{(gT+g3)}$	=	5.9 pF
Output capacitance	C_a	=	2.4 pF
Anode - grid	$C_{(gT+g3)a}$	=	1.3 pF

ECH 42

Between hexode system and triode system

Between the two control grids	$C_{(gT+g3)g1H}$	<	0.35 pF
Between hexode control grid and triode anode	C_{g1HaT}	<	0.06 pF
Between triode grid and hexode anode	$C_{(gT+g3)aH}$	<	0.2 pF
Between the two anodes	C_{aHaT}	<	0.5 pF

Operating characteristics of the hexode system used as mixer (see Figs. 6 to 11 incl.)

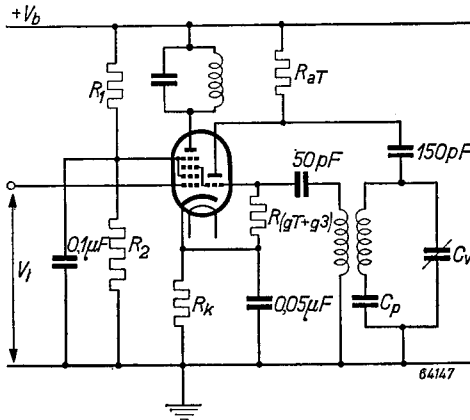

Fig. 3

Anode and supply voltage	$V_a = V_b$	=	250	V
Potentiometer for feeding screen grids (Fig. 3)	$\begin{cases} R_1 \\ R_2 \end{cases}$	=	27	kΩ
Biasing resistor	R_k	=	180	Ω
Oscillator grid leak	R_{gT+g3}	=	22 ¹⁾	kΩ
Oscillator grid current	I_{gT+g3}	=	350 ¹⁾	μA
Grid bias	V_{g1}	=	-2	-29 V
Screen grid voltage	V_{g2+g4}	=	85	124 V
Anode current	I_a	=	3.0	— mA
Screen grid current	I_{g2+g4}	=	3.0	— mA
Conversion conductance	S_c	=	750	7.5 μA/V
Internal resistance	R_i	=	1.7	>5 MΩ
Equivalent noise resistance	R_{eq}	=	100	— kΩ

¹⁾ If the grid leak is 47 kΩ instead of 22 kΩ, an oscillator grid current of 200 μA is recommended ; none of the other values is affected.

Typical characteristics of the triode section (see Figs. 14 and 15)

Anode voltage	V_a	=	100 V
Grid voltage	V_g	=	0 V
Anode current	I_a	=	10 mA
Slope	S	=	2.8 mA/V
Amplification factor	μ	=	22

Operating characteristics of the triode section used as oscillator (see Figs. 12 and 13)

Supply voltage	V_b	=	250	250 V
Resistor in anode circuit	R_a	=	33	33 k Ω
Grid leak	R_{gT+g3}	=	47	22 k Ω
Grid current	I_{gT+g3}	=	200	350 μ A
Anode current	I_a	=	4.8	5.1 mA
Oscillator voltage	V_{osc}	=	8	8 V _{RMS}
Effective slope	S_{eff}	=	0.55	0.6 mA/V

Operating characteristics of the ECH 42 used as phase inverter (see Fig. 4)

Supply voltage	V_b	=	250	350 V
Total current	I_b	=	3.6	5.1 mA
Amplification	V_o/V_i	=	11	11
Distortion at output voltage of	$\left\{ \begin{array}{l} 5 \text{ V}_{RMS} \text{ } d \\ 10 \text{ V}_{RMS} \text{ } d \\ 15 \text{ V}_{RMS} \text{ } d \end{array} \right.$	=	1.2	1.1 %
		=	1.4	1.2 %
		=	1.7	1.4 %

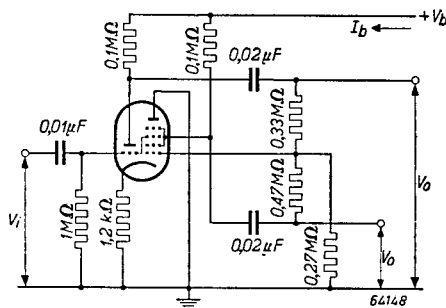

Fig. 4
Circuit diagram showing the ECH 42 used as phase inverter.

ECH 42

Operating characteristics of the hexode section used as mixer; screen grids of the ECH 42 and I.F. amplifying valve EAF 42 fed by means of a common potentiometer (see Figs. 16 and 17).

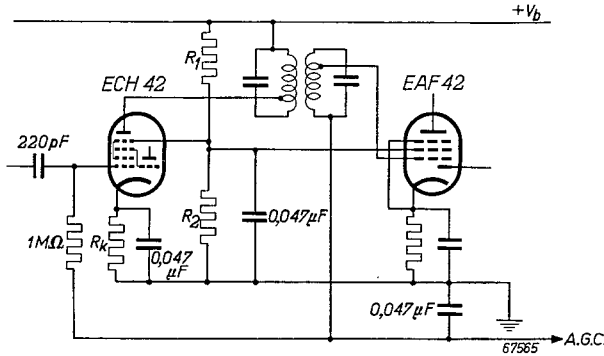

Fig. 5

Anode and supply voltage	$V_a = V_b$	=	250	V
Potentiometer for screen grid voltage	$\left\{ \begin{array}{l} R_1 \\ R_2 \end{array} \right.$	=	22	k Ω
			=	27
Biasing resistor	R_k	=	180	Ω
Oscillator grid leak	R_{gT+g3}	=	22 ¹⁾	k Ω
Oscillator grid current	I_{gT+g3}	=	350 ¹⁾	μA
Grid bias	V_{g1}	=	$\overbrace{-2 \text{ — } 20.5}^{\text{V}}$	
Screen grid voltage	V_{g2+g4}	=	85	135 V
Anode current	I_a	=	3.0	— mA
Screen grid current	I_{g2+g4}	=	3.0	— mA
Conversion conductance	S_c	=	750	24 $\mu\text{A/V}$
Internal resistance	R_i	=	1.7	> 5 M Ω
Equivalent noise resistance	R_{eq}	=	100	— k Ω

1) If the oscillator grid leak is 47 k Ω , the recommended oscillator grid current is 200 μA . The operating conditions of the valve are not affected.

Operating characteristics of the hexode section used as mixer; (screen grid voltage derived from the same potentiometer as that for the I.F. amplifier EF 41 (see Figs. 18 and 19)

Anode and supply voltage	$V_a = V_b$	=	250	V
Potentiometer for screen grid voltage	$\left\{ \begin{array}{l} R_1 \\ R_2 \end{array} \right.$	=	22	k Ω
Biasing resistor	R_k	=	27	k Ω
Oscillator grid leak	R_{gT+g3}	=	180	Ω
Oscillator grid current	I_{gT+g3}	=	22 ¹⁾	k Ω
Grid bias	V_{g1}	=	350 ¹⁾	μ A
Screen grid voltage	V_{g2+g4}	=	$\overbrace{-2 \quad -22}^{\text{---}}$	V
Anode current	I_a	=	85	135
Screen grid current	I_{g2+g4}	=	3.0	—
Conversion conductance	S_c	=	3.0	—
Internal resistance	R_i	=	750	20 μ A/V
Equivalent noise resistance	R_{eq}	=	1.7	>5 M Ω
		=	100	—

Limiting values of the hexode section

Anode voltage, valve biased to cut-off	V_{a_c}	=	max.	550	V
Anode voltage	V_a	=	max.	300	V
Anode dissipation	W_a	=	max.	1.5	W
Screen grid voltage, valve biased to cut-off	$V_{(g2+g4)_0}$	=	max.	550	V
Screen grid voltage with control applied to valve	$V_{g2+g4}(I_a < 1\text{mA})$	=	max.	300	V
Screen grid voltage with no control applied	$V_{g2+g4}(I_a = 3\text{mA})$	=	max.	125	V
Screen grid dissipation	W_{g2+g4}	=	max.	0.3	W
Grid current starting point	$V_{g1}(I_{g1} = +0.3\mu\text{A})$	=	max.	-1.3	V
Cathode current	I_k	=	max.	10	mA
External resistance between first grid and cathode	R_{g1}	=	max.	3	M Ω^2)
External resistance between third grid and cathode	R_{g3}	=	max.	3	M Ω
External resistance between cathode and heater	R_{fk}	=	max.	20	k Ω
Voltage between cathode and heater	V_{fk}	=	max.	100	V

¹⁾ See footnote page 80.

²⁾ This value is applicable when automatic grid bias is employed.

ECH 42

Limiting values of the triode section

Anode voltage, valve biased to cut-off	V_{a_0}	= max.	550 V
Anode voltage	V_a	= max.	175 V
Anode dissipation	W_a	= max.	0.8 W
Grid current starting point	$V_g(I_g = +0.3\mu\text{A})$	= max.	-1.3 V
Cathode current	I_k	= max.	6 mA
External resistance between grid and cathode	R_g	= max.	3 M Ω
External resistance between cathode and heater.	R_{fk}	= max.	20 k Ω
Voltage between cathode and heater	V_{fk}	= max.	100 V

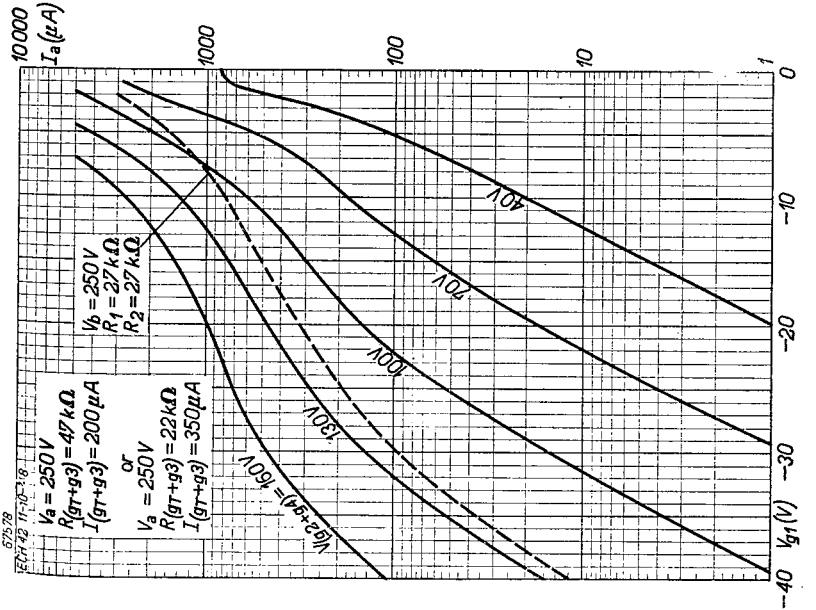
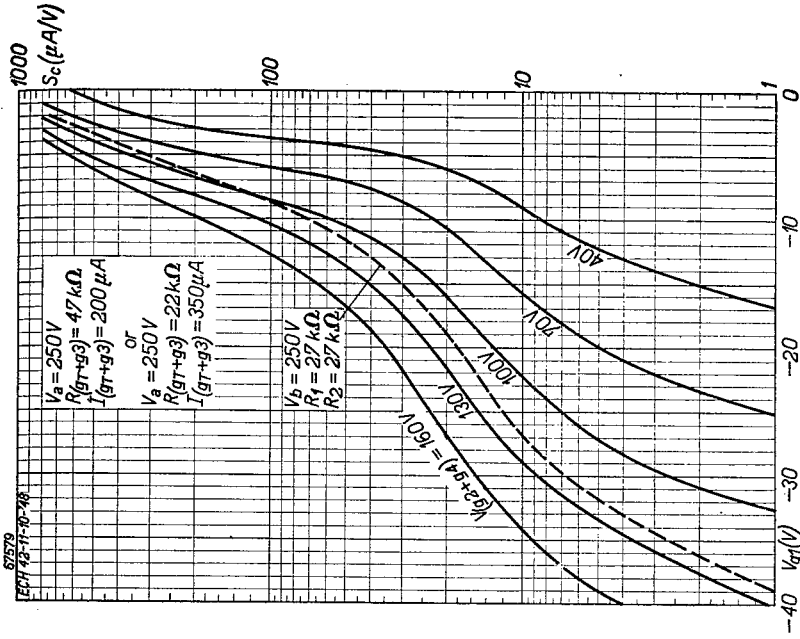

Fig. 6

Anode current (I_a , Fig. 6) and conversion conductance (S_c , Fig. 7) of the hexode section, as functions of the grid bias (V_{g1}) with screen grid voltage (V_{g2+g3}) as parameter. The dotted lines indicate the anode current and conversion conductance when the screen grid voltage is derived from a potentiometer R_1 , R_2 (see Fig. 3).

Fig. 7



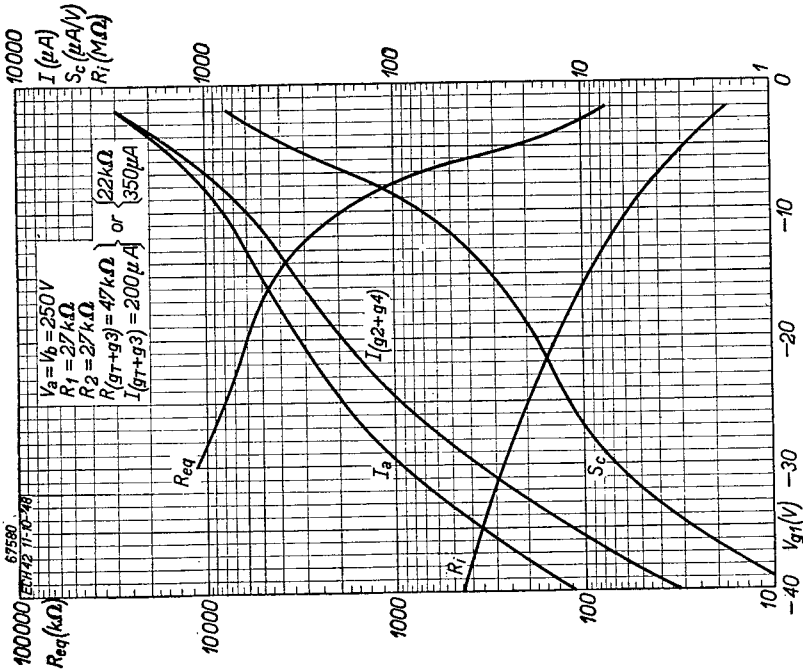

Fig. 8
 Anode current (I_a), screen grid current (I_{g2+g4}), conversion conductance (S_c), internal resistance (R_i) and equivalent noise resistance (R_{eq}) as functions of the grid bias (V_{g1}). Measured in the circuit shown in Fig. 3.

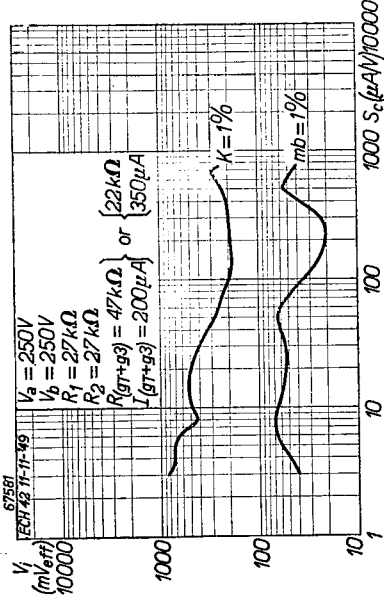

Fig. 9
 1) The strength of an interfering signal on the control grid (V_j) producing 1% cross modulation (curve $K=1\%$), and
 2) the strength of a hum signal on the control grid (V_j) producing 1% hum modulation (curve $mb=1\%$), both as functions of the conversion conductance (S_c). Measured in the circuit shown in Fig. 3.

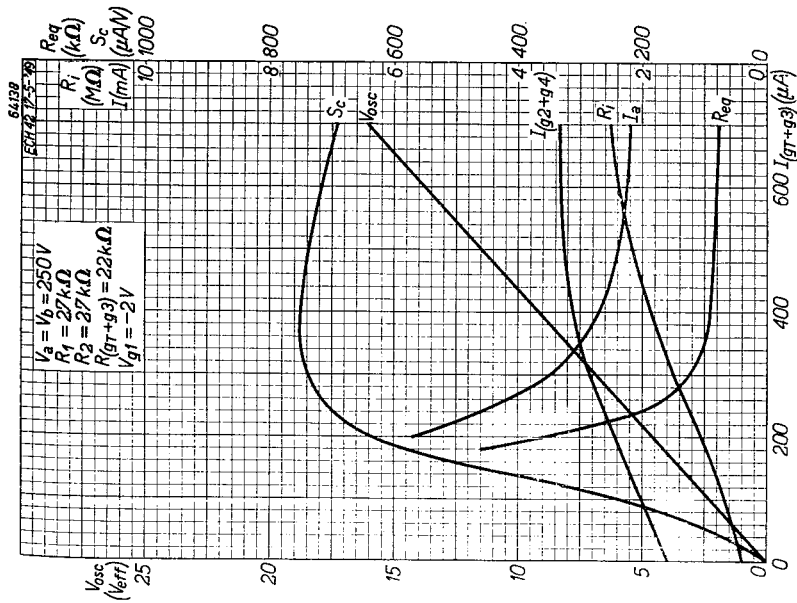

Fig. 10

Anode current (I_a), screen grid current (I_{g2+g4}), oscillator voltage (V_{osc}), conversion conductance (S_c), internal resistance (R_i) and equivalent noise resistance (R_{eq}) as functions of the oscillator grid leak.

Fig. 10 : Oscillator grid leak $R_{g1+g3} = 22 k\Omega$.
 Fig. 11 : Oscillator grid leak $R_{g1+g3} = 47 k\Omega$.

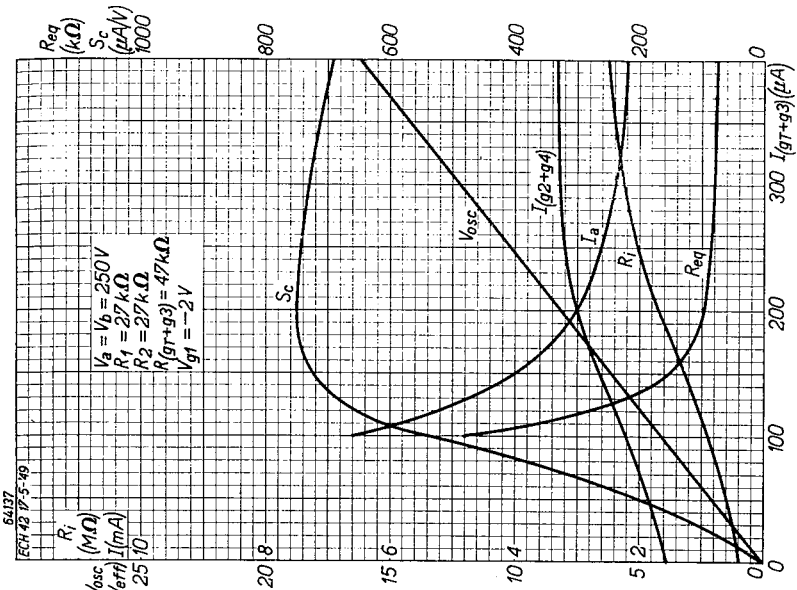

Fig. 11

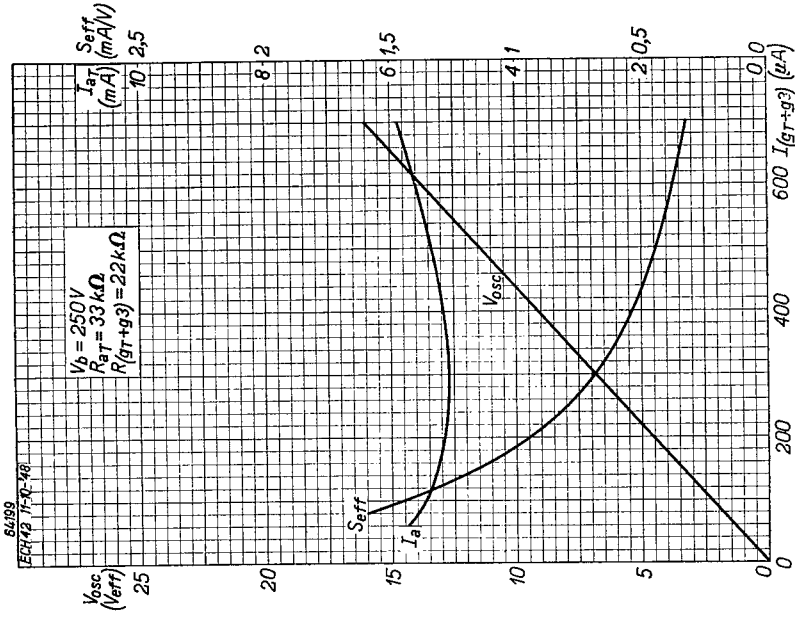

Fig. 13

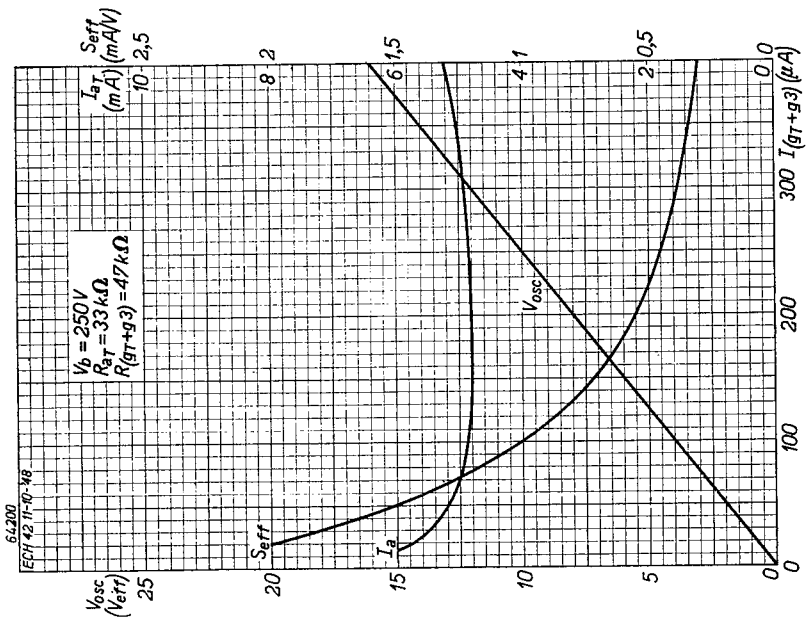

Fig. 12

Triode system : anode current (I_{aT}), oscillator voltage (V_{osc}) and effective slope (S_{eff}) as functions of the oscillator grid current (I_{gT+g3}).

Fig. 12 : Oscillator grid leak $R_{gT+g3} = 47\text{ k}\Omega$.

Fig. 13 : Oscillator grid leak $R_{gT+g3} = 22\text{ k}\Omega$.

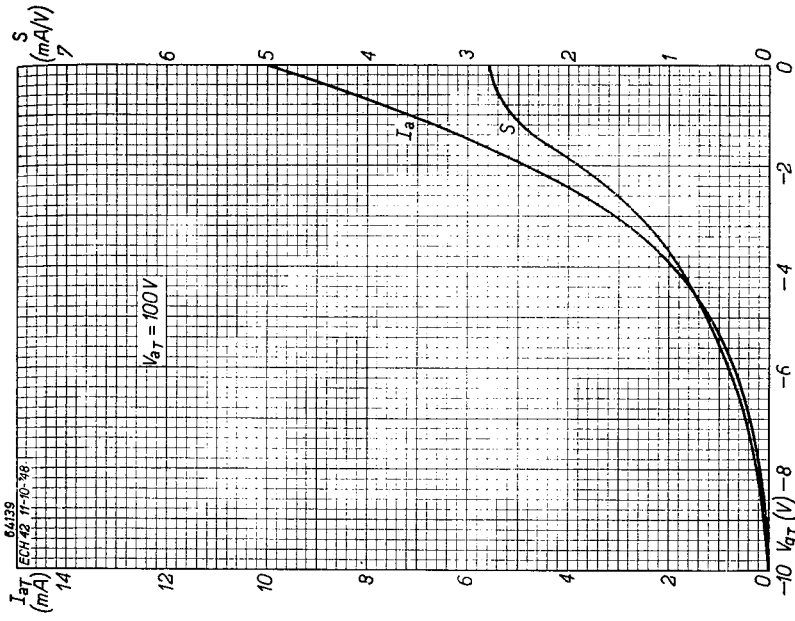

Fig. 14

Anode current (I_a) and slope (S) of the triode system as functions of the grid bias (V_{gT}). Measurements taken from non-oscillating valve at an anode voltage (V_{aT}) of 100 V.

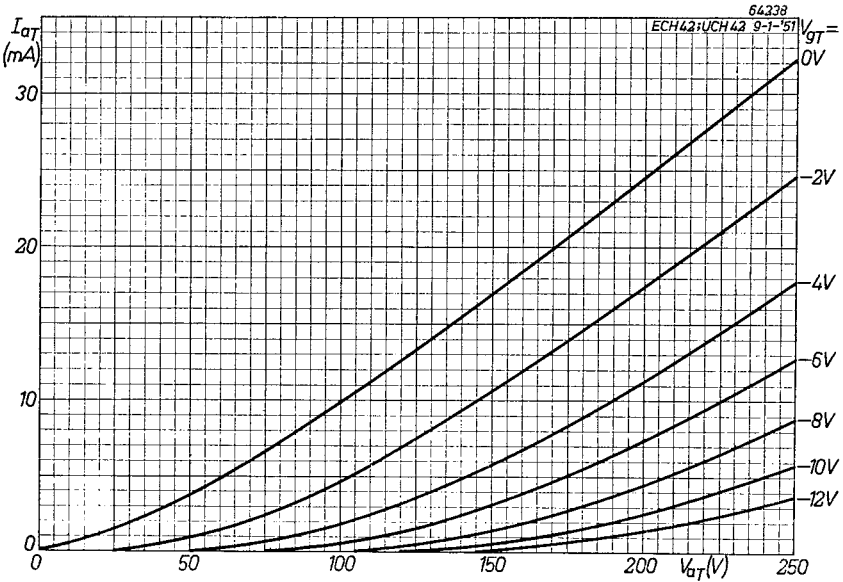

Fig. 15

I_a/V_a characteristics of the triode section of the ECH 42; static measurements.

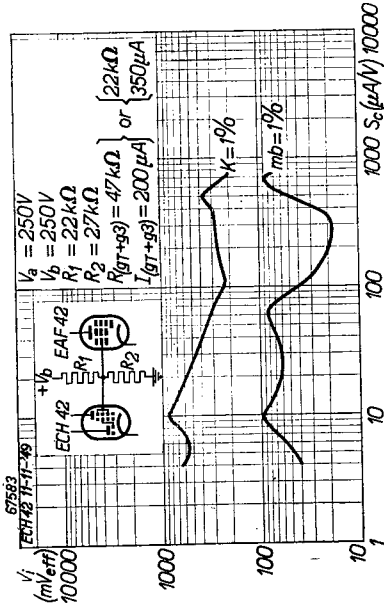

Fig. 17

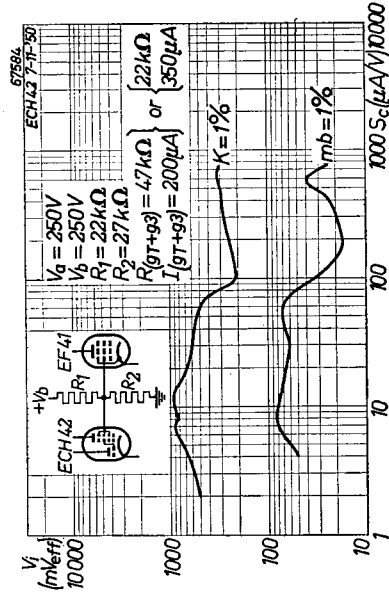

Fig. 18

As Fig. 9, but with screen grid voltage of the ECH 42 and I.F. amplifying valve supplied by means of a common potentiometer R_1, R_2 .
Fig. 17: I.F. amplifier EAF 42.
Fig. 18: I.F. amplifier EF 41.

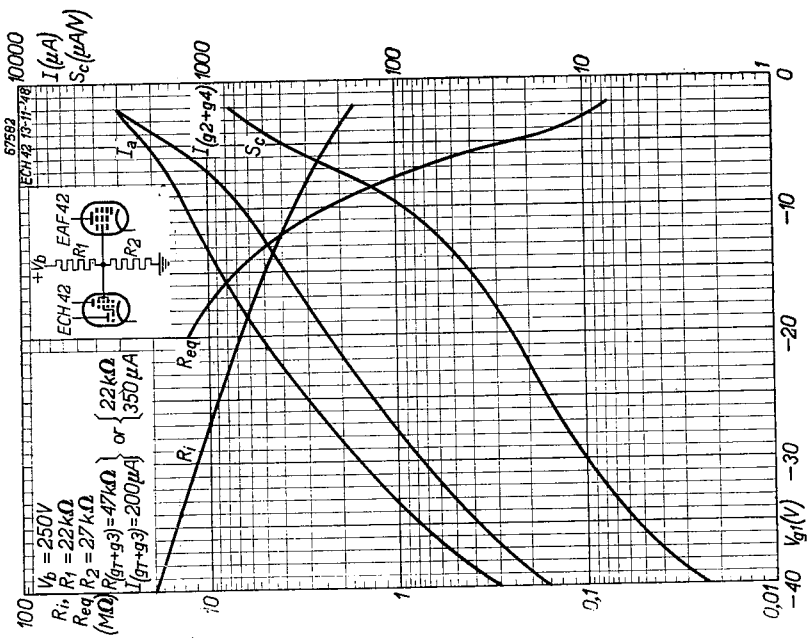

Fig. 16

As Fig. 8, but with screen grid voltage of the ECH 42 and I.F. amplifying valve EAF 42 derived from a common potentiometer R_1, R_2 .

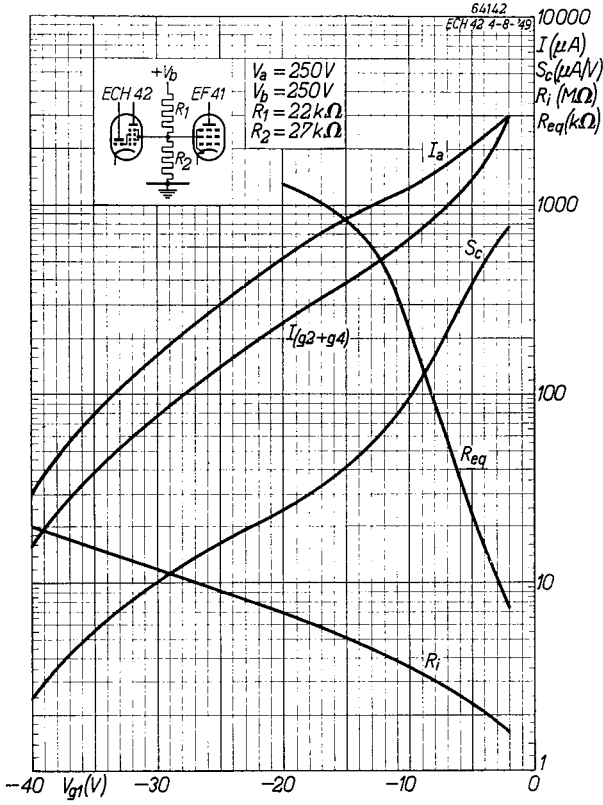

Fig. 19

As Fig. 8, but with screen grid voltage of the ECH 42 and that of the EF 41 obtained by means of a common potentiometer.

EF 41

EF 41 Variable-mu R.F. pentode

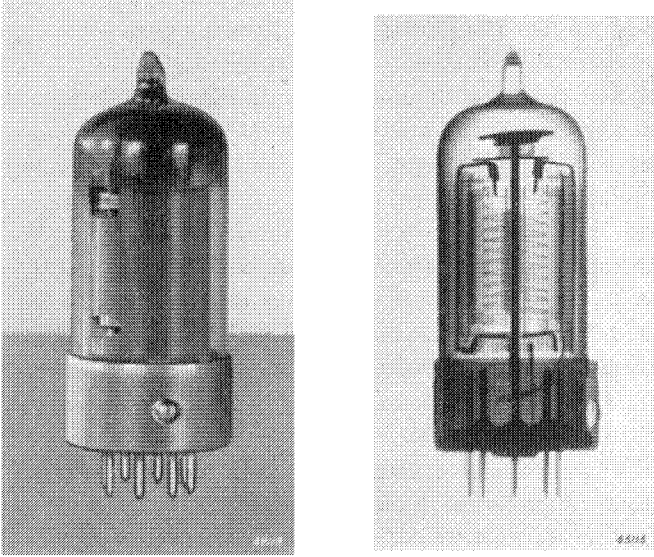

Fig. 1
Normal and X-ray photographs of the EF 41 (approximately actual size).

The EF 41 is a variable-mu pentode suitable for R.F. and I.F. amplification in A.C. receivers and car-radio sets. The slope, in the absence of control, is 2.2 mA/V and the internal resistance 1.1 M Ω .

The excellent properties of this valve from the point of view of cross-modulation when gain control is applied are most apparent when a sliding screen grid voltage is employed, a series resistance of 90 k Ω being included in the screen grid circuit. In the uncontrolled condition, with a grid bias of -2.5 V, the screen grid potential is 100 V in that case; with a bias of -39 V, the mutual conductance is reduced to 1/100th of its original value.

As in the EAF 42, the entire electrode system is enclosed in a metal shield inside the envelope, so that no external screening is needed. The anode and control grid lead-in wires are also carefully screened, so that the grid-to-anode capacitance is at most 0.002 pF and the risk of undesirable feedback from the anode to the control grid circuit is reduced to a minimum. Nevertheless, it is still essential to press the valve well home in its holder and to bend the lugs on the raised metal edge of the valveholder slightly inwards (the reasons for these measures are given in the description of the EAF 42). Used as an I.F. amplifying valve, the EF 41 is found chiefly in sets employing the EBC 41 as A.F. amplifier. Two separate diodes are then available for detection and A.G.C. This offers special advantages in all cases where delayed A.G.C. is required.

In view of the fact that the EF 41 is usually employed as I.F. amplifier in conjunction with an A.F. stage, the reserve gain is sufficient to allow the diodes and anode of the pentode to be connected to tappings on the I.F. coils, for greater selectivity. If such tappings are provided at points equal to 7/10ths of the coil, and if the quality factor of the coils $Q=140$, an I.F. amplification of about 120 will be obtained.

As an R.F. amplifying valve, the EF 41 is particularly suitable for receivers in which a good short-wave reception is required. Owing to the small quality factor of the tuned short-wave circuits the sensitivity will be smaller than at longer wavelengths and the signal-to-noise ratio less favourable. Naturally, such a higher amplification can also be obtained by means of an extra I.F. stage, but in that case the signal-to-noise ratio is governed by the noise produced by the frequency changer, which is some 10 times more pronounced than that due to the R.F. valve. This explains why a short-wave receiver often includes an R.F. stage, despite the fact that this arrangement is more complicated than an extra I.F. stage.

In view of its small size, the EF 41 — like all Rimlock type valves — is an excellent valve for car radio, where space is relatively limited.

In common with the EAF 42, the screen grid of the EF 41 can be fed from the same source as the screen grids of the frequency changer (ECH 41 or ECH 42); see Fig. 2.

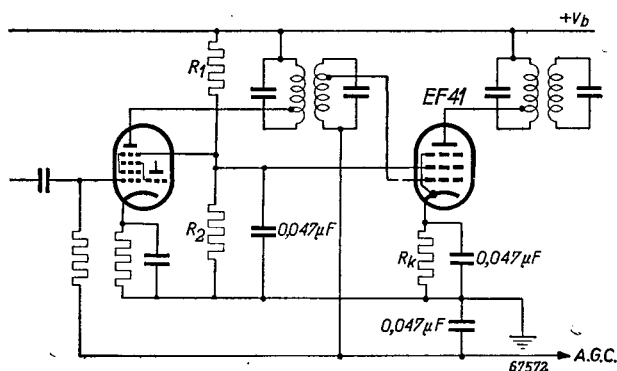

Fig. 2

The EF 41 is used as I.F. amplifier, with screen grid voltage derived from the same potentiometer as that which is used to feed the screen grids of the frequency changer.

EF 41

TECHNICAL DATA OF THE R.F. PENTODE EF 41

Heater data

Heating: indirect, A.C. or D.C., parallel feed

Heater voltage	V_f	=	6.3 V
Heater current	I_f	=	0.2 A

Capacitances (cold valve)

Input capacitance	C_{g1}	=	5.3 pF
Output capacitance	C_a	=	5.9 pF
Anode - control grid	C_{ag1}	<	0.002 pF
Heater - control grid	C_{gf}	<	0.1 pF

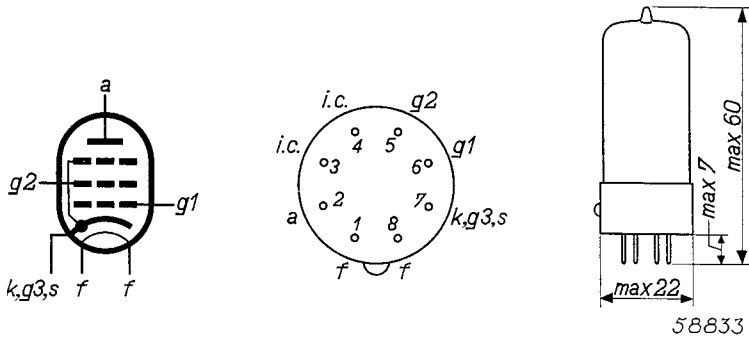

Fig. 3

Electrode arrangement, electrode connections and maximum dimensions (in mm) of the EF 41.

Operating characteristics of the EF 41 used as R.F. or I.F. amplifier; (see Figs. 4, 5 and 7)

Anode and supply voltage	$V_b = V_a$	=	250 V
Screen grid resistor	R_{g2}	=	90 kΩ
Biasing resistor	R_k	=	325 Ω
Grid bias	V_{g1}	=	-2.5 — -39 V
Anode current	I_a	=	6 — mA
Screen grid current	I_{g2}	=	1.7 — mA
Slope	S	=	2200 — 22 μA/V
Internal resistance	R_i	=	1.1 > 10 MΩ
Equivalent noise resistance	R_{eq}	=	6.5 — kΩ
Amplification factor of the second grid with respect to the first	μ_{g2g1}	=	18 —

Operating characteristics of the EF 41 used as R.F. or I.F. amplifier; screen grid voltage of EF 41 and that of ECH 42 derived from a common potentiometer (see Figs. 2 and 10). (For details of the ECH 42 in this circuit, see page 81)

Anode and supply voltage	$V_b = V_a$	=	250	V
Resistor between supply voltage and screen grids	R_1	=	22	k Ω
Resistor between screen grids and chassis	R_2	=	27	k Ω
Biasing resistor	R_k	=	310	Ω
Grid bias	V_{g1}	=	$\overbrace{-2 \quad -22}^{\text{V}}$	
Screen grid voltage	V_{g2}	=	85	135 V
Anode current	I_a	=	5.0	— mA
Screen grid current	I_{g2}	=	1.5	— mA
Slope	S	=	2000	20 $\mu\text{A}/\text{V}$
Internal resistance	R_i	=	1.4	>10 M Ω
Equivalent noise resistance	R_{eq}	=	7.5	— k Ω
Amplification factor of second grid with respect to the first	μ_{g2g1}	=	18	—

Limiting values

Anode voltage, valve biased to cut-off	V_{a_o}	= max.	550	V
Anode voltage	V_a	= max.	300	V
Anode dissipation	W_a	= max.	2	W
Screen grid voltage, valve biased to cut-off	V_{g2_o}	= max.	550	V
Screen grid voltage, valve controlled	$V_{g2}(I_a < 3\text{mA})$	= max.	300	V
Screen grid voltage, valve uncontrolled	$V_{g2}(I_a = 6\text{mA})$	= max.	125	V
Screen grid dissipation	W_{g2}	= max.	0.3	W
Cathode current	I_k	= max.	10	mA
Grid current starting point	$V_{g1}(I_{g1} = +0.3\mu\text{A})$	= max.	-1.3	V
External resistance between first grid and cathode	R_{g1}	= max.	3	M Ω ¹⁾
External resistance between heater and cathode	R_{fk}	= max.	20	k Ω
Voltage between heater and cathode	V_{fk}	= max.	100	V

¹⁾ This value is applicable where the grid bias is obtained by means of a biasing resistor.

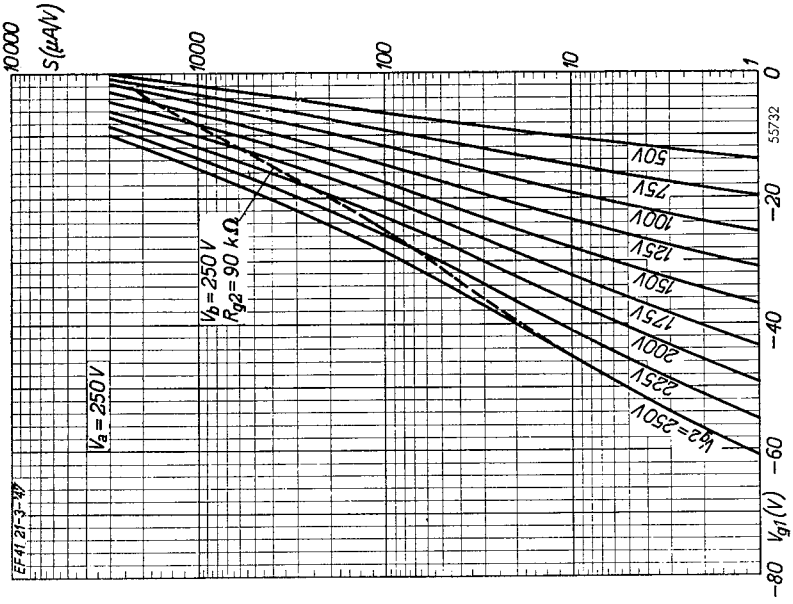

Fig. 5

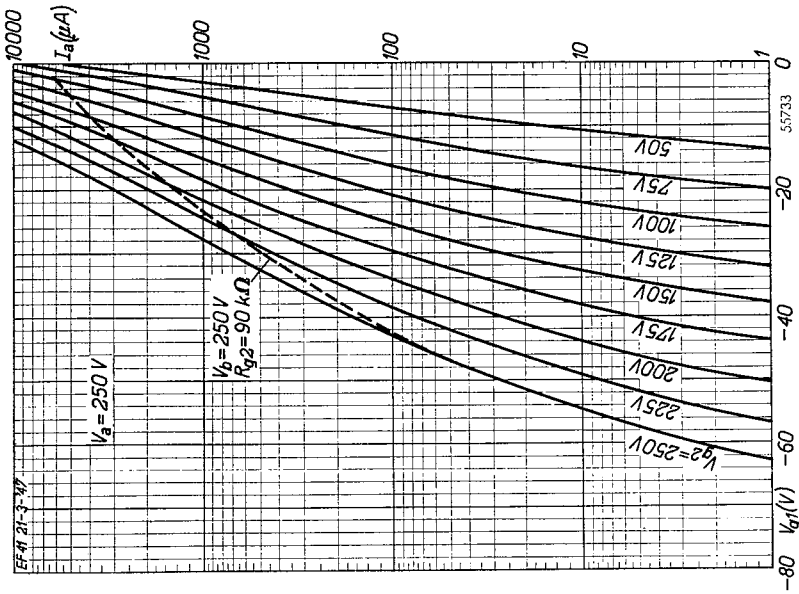

Fig. 4

Anode current I_a (Fig. 4) and slope S (Fig. 5) as functions of the grid bias V_{g1} for various values of the screen grid voltage V_{g2} . The dotted lines indicate the I_a (Fig. 4) and S (Fig. 5) when the screen grid feed is applied through a series resistor R_{g2} of 90 k Ω .

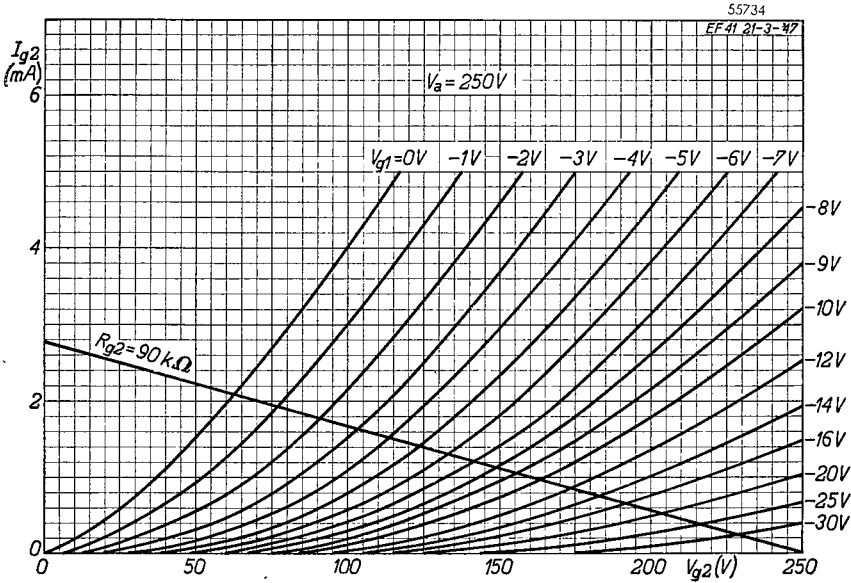

Fig. 6
Screen grid current I_{g2} as a function of the screen grid voltage V_{g2} for various values of the grid bias V_{g1} . The straight line represents the load line, with a screen grid series resistor R_{g2} of 90 kΩ.

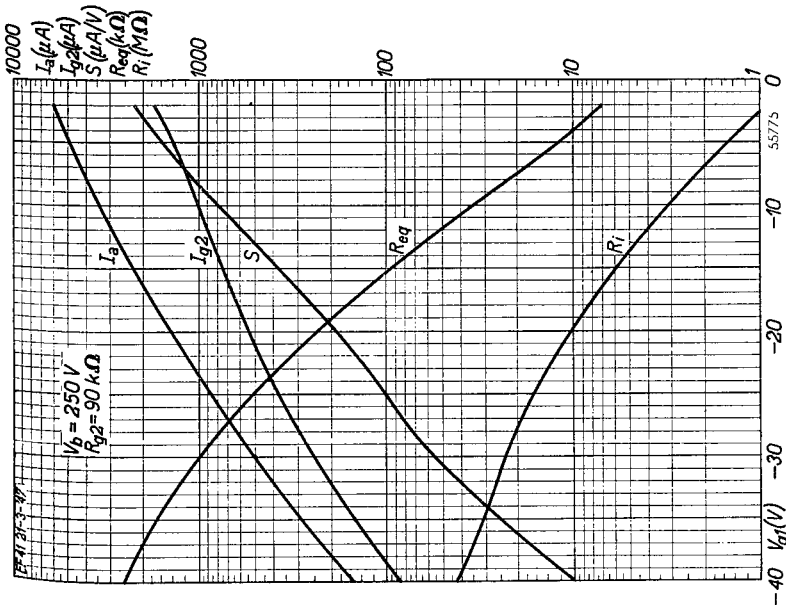

Fig. 7
Anode current I_a , screen grid current I_{g2} , slope S , internal resistance R_i , and equivalent noise resistance R_{eq} as functions of the grid bias V_{g1} with sliding screen grid voltage ($R_{g2} = 90 k\Omega$).

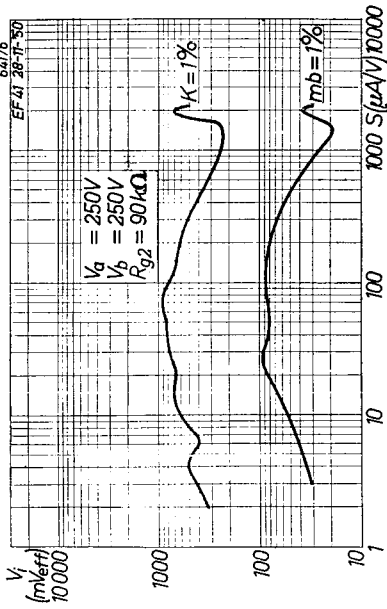

Fig. 8. The effective value V_i of an interfering signal on the control grid, producing 1% cross-modulation; also the effective value V_i of a hum signal on the control grid, producing 1% hum modulation, both as a function of the slope S .

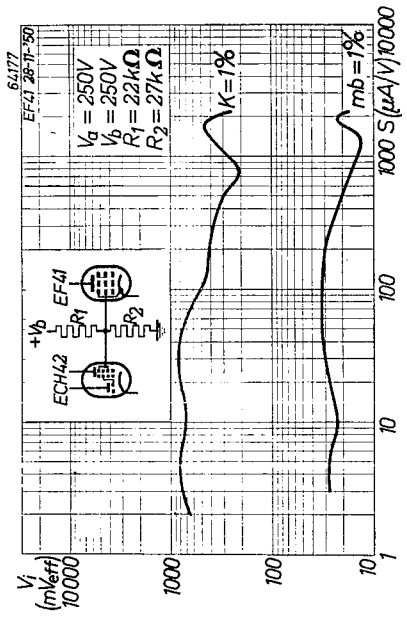

Fig. 9. As Fig. 8, with the screen grid voltage of the EF 41 and that of the ECH 42 applied by means of the same potentiometer.

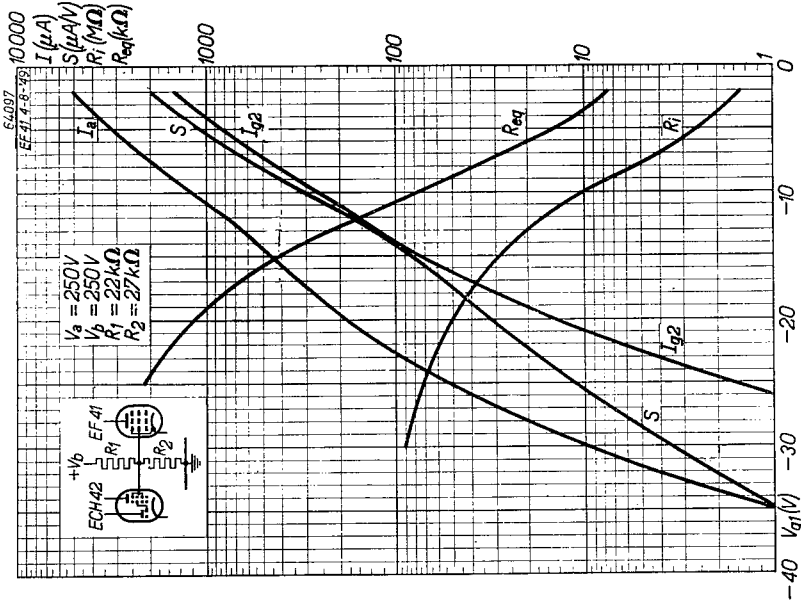

Fig. 10

As Fig. 7, but with the screen grid voltage of the EF 41 and that of the frequency changer ECH 42 applied by means of the same potentiometer.

EL 41 9 W output pentode

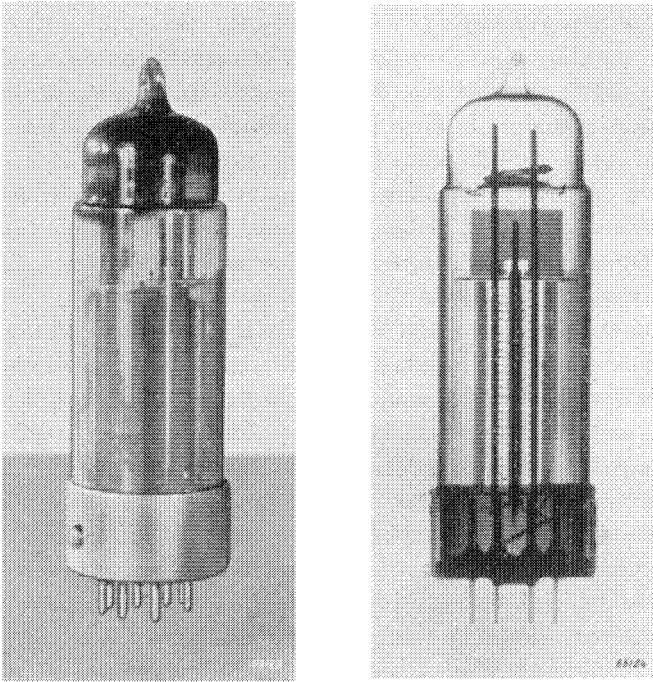

Fig. 1

Normal and X-ray photographs of the EL 41 (approximately actual size).

The EL 41 is an indirectly heated output pentode having a slope of 10 mA/V . The maximum permissible anode dissipation of this valve is 9 W and, for an A.C. grid voltage of only 3.8 V_{RMS} , the output power is 3.9 W , with 10% distortion. Owing to the fact that no current flows to the control grid at an A.C. voltage of this value (the grid bias is 7 V without input signal), the output can be raised considerably without very much increase in the distortion. Grid current does not commence to flow until the output reaches 4.8 W , at which point the distortion is 14.5% , the required input signal being 5.1 V_{RMS} .

In a class A push-pull amplifier, with $V_a = V_{g2} = 250 \text{ V}$, an output of 9.4 W with 4.6% distortion can be obtained for an alternating grid voltage of 5.6 V_{RMS} .

Connected as a triode (screen grid connected to anode), the EL 41 will deliver 1.55 W with 8% distortion on an anode voltage of 250 V . In either of these circuits, however, care should be taken that the leads to the various electrodes be kept short in order to avoid undesirable coupling and so ensure that no parasitic oscillation can occur in view of the high mutual conductance

EL 41

of the valve. If oscillation does occur, owing to imperfect wiring, it can be suppressed by including in the control grid and/or screen grid circuits resistors of 1000 and 100 Ω respectively, without decoupling capacitor. These resistors should be connected as closely as possible to the valveholder. Grid bias for the EL 41 should be only of the automatic or semi-automatic kind, i.e. as provided by a resistor in the cathode circuit, or by a resistor in the common negative line of the receiver. In the latter case the cathode current of the EL 41 should constitute at least 50% of the total current flowing through the resistor.

With automatic bias, the external resistance between control grid and cathode must not exceed 1 M Ω ; with semi-automatic bias this resistance should be lower, the maximum value being obtained from the formula :

$$Rg_1 = \max. \frac{\text{cathode current of the EL 41}}{\text{total current flowing through the resistor}} R'g_1,$$

where $R'g_1$ is the maximum permissible external resistance between grid and cathode for automatic bias.

As previously stated, the maximum anode dissipation of the EL 41 is 9 W; to illustrate the full significance of this, certain points should be explained: As a rule, when the set is in operation, the anode dissipation in the output valve of a receiver is not constant, and among sets of the same type the anode dissipation of the output valve will be found to vary considerably. Several factors contribute to these differences, the most important of these being the tolerances on the various components and valves in the circuit, fluctuations in the mains voltage and, in some circuits, the effects of the A.G.C. If the grid bias of the output valve is of the semi-automatic kind (see previous paragraph), the bias will drop when the A.G.C. comes into operation because the currents flowing through the R.F. and I.F. valves are then reduced. In consequence, the anode dissipation in the output valve increases.

For a better understanding of the significance of "a maximum permissible anode dissipation of 9 W"²² the following factors have been established :

If the anode dissipation of an average EL 41 valve in a receiver does not exceed 9 W when :

- 1) the valve is operating on nominal voltages,
- 2) the components of the circuit are of nominal value, and
- 3) no input signal is applied,

it is permissible :

- a) to use any EL 41 valve in the set in question,
- b) to allow the anode dissipation to exceed the specified 9 W by a maximum of 15%, by reason of deviating values of the components and the effects of the A.G.C.,
- c) to allow fluctuations of at most + or - 10% in the mains voltage.

As will be seen from the above, it is intended that the average anode dissipation of the EL 41 in a receiver shall be 9 W when no input signal is applied. There is then sufficient reserve: (a) to allow for the customary tolerances on components, voltages and valves without risk of the valve being overloaded, and (b) to avoid any difficulties when the A.G.C. comes into operation. If

abnormal deviations in voltages or values of components are anticipated, the average anode dissipation without input signal should be re-adjusted accordingly.

When the EL 41 is to be used as the output valve in a vibrator-driven set, the above condition no longer applies as far as the line voltage is concerned, since the voltage is then obtained from an accumulator, not from the mains, and large fluctuations are likely to occur. In such cases the average anode dissipation should be adjusted to 9 W (without input signal) for an accumulator voltage of 7 V. The voltage may then safely rise to 8 V without overloading the valve. In addition, an increase in the dissipation of 15% beyond the limit can be allowed as a maximum, to meet deviations of the components of the circuit, as well as the effects of the A.G.C.

The lower limit specified for the accumulator voltage should be 5.5 V : if the voltage is allowed to drop any further, the heater will be under-heated, which, in the long run, will impair the emissive properties of the cathode.

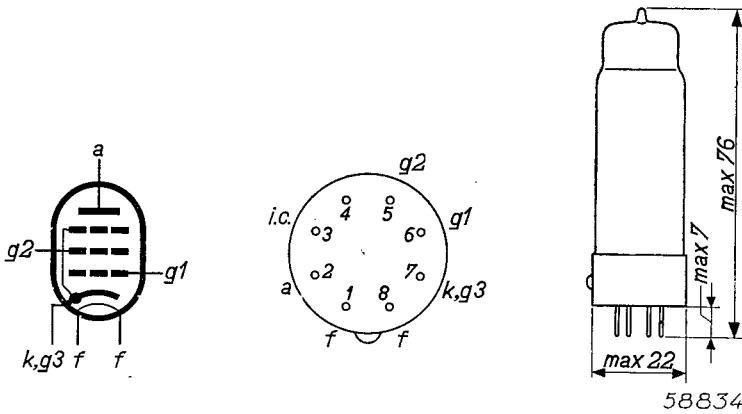

Fig. 2
Electrode arrangement, electrode connections and maximum dimensions in mm of the EL 41.

EL 41

TECHNICAL DATA OF THE OUTPUT PENTODE EL 41

Heater data

Heating : indirect by A.C. or D.C. ; parallel feed		
Heater voltage	V_f	= 6.3 V
Heater current	I_f	= 0.71 A

Capacitances (measured at the cold tube)

Input capacitance	C_{g1}	= 10.2 pF
Output capacitance	C_a	= 7.8 pF
Anode-control grid	C_{ag1}	< 1 pF
Control grid-heater	C_{g1f}	< 0.15 pF

Operating characteristics as Class A output amplifier (see Fig. 7)

Anode voltage	V_a	= 250 V
Screen grid voltage	V_{g2}	= 250 V
Cathode resistor	R_k	= 170 Ω
Control grid bias	V_{g1}	= -7 V
Anode current	I_a	= 36 mA
Screen grid current	I_{g2}	= 5.2 mA
Mutual conductance	S	= 10 mA/V
Internal resistance	R_i	= 40 k Ω
Amplification factor of the 2nd grid with respect to the 1st grid	μ_{g2g1}	= 22
Matching resistance	R_a	= 7 k Ω
Output power at 10% distortion	$W_o(d_{tot}=10\%)$	= 3.9 W
A.C. input voltage at 10% distortion	$V_i(d_{tot}=10\%)$	= 3.8 V _{RMS}
Output power at grid current starting point	$W_o(I_{g1}=+0.3\mu A)$	= 4.8 W
Sensitivity	$V_i(W_o=50 \text{ mW})$	= 0.32 V _{RMS}

Operating characteristics of 2 valves as Class A push-pull amplifier

(without grid current) (see Fig. 8)

Anode voltage	V_a	= 250 V
Screen grid voltage	V_{g2}	= 250 V
Common cathode resistor	R_k	= 85 Ω
Matching resistance	R_{aa}	= 7 k Ω
A.C. input voltage	V_i	= 0 $\overbrace{2 \times 39.5}^{5.6}$ V _{RMS}
Anode current	I_a	= 2×36 2×39.5 mA
Screen grid current	I_{g2}	= 2×5.2 2×8 mA
Output power	W_o	= 0 9.4 W
Total distortion	d_{tot}	= — 4.6 %

Operating characteristics of one valve as Class A output amplifier in triode connection (screen grid connected to anode) (see Fig. 9)

Anode voltage	V_a	=	250 V
Cathode resistor	R_k	=	250 Ω
Anode current	$I_a + I_{g2}$	=	33 mA
Matching resistance	R_a	=	3.5 k Ω
Output power	W_o	=	1.55 W
A.C. input voltage	V_i	=	6 V _{RMS}
Total distortion	d_{tot}	=	8 %

Limiting values

Anode voltage in cut-off condition	V_{a_c}	= max.	550 V
Anode voltage	V_a	= max.	300 V
Anode dissipation	W_a	= max.	9 W
Screen grid voltage in cut-off condition	V_{g2_o}	= max.	550 V
Screen grid voltage	V_{g2}	= max.	300 V
Screen grid dissipation without input signal	$W_{g2}(V_i=0)$	= max.	1.4 W
Screen grid dissipation at full modulation	$W_{g2}(W_o=\text{max.})$	= max.	3.3 W
Cathode current	I_k	= max.	55 mA
Grid current starting point	$V_{g1}(I_{g1}=+0.3\mu\text{A})$	= max.	-1.3 V
External resistance between control grid and cathode	R_{g1}	= max.	1 M Ω ¹⁾
External resistance between cathode and heater	R_{fk}	= max.	20 k Ω
Voltage between cathode and heater	V_{fk}	= max.	100 V

¹⁾ With automatic grid bias, see page 98.

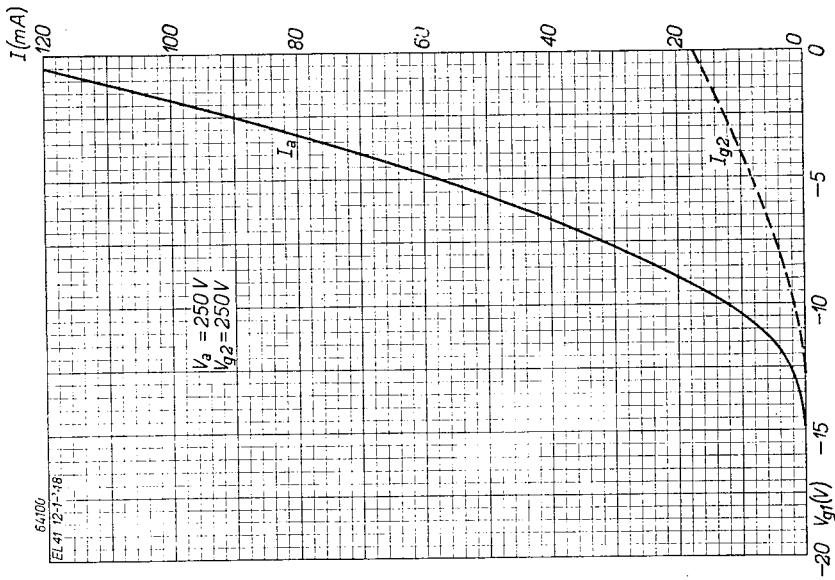

Fig. 3
Anode current I_a and screen grid current I_{g2} as functions of the grid bias V_{g1} at anode voltage V_a and screen grid voltage $V_{g2} = 250 V$.

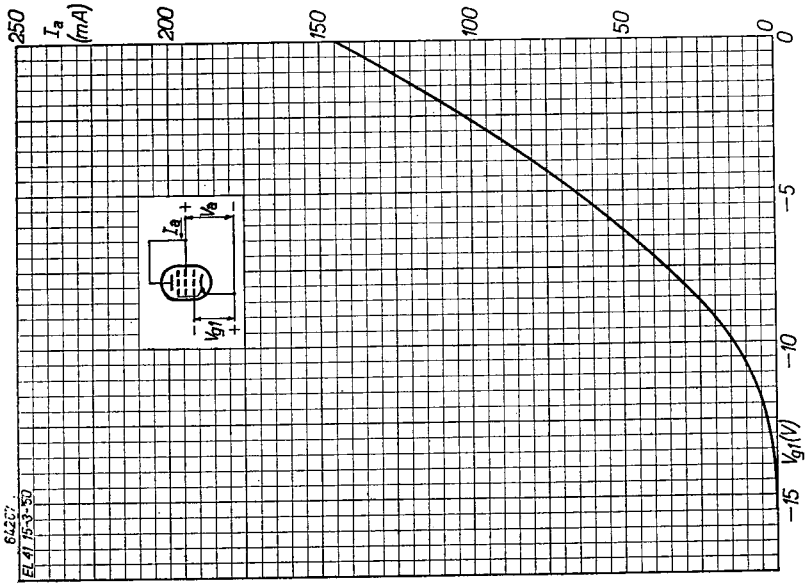

Fig. 4
EL 41 connected as triode (screen grid connected to anode). Anode current I_a (including screen grid current) as a function of the grid bias V_{g1} , for an anode voltage V_a of 250 V.

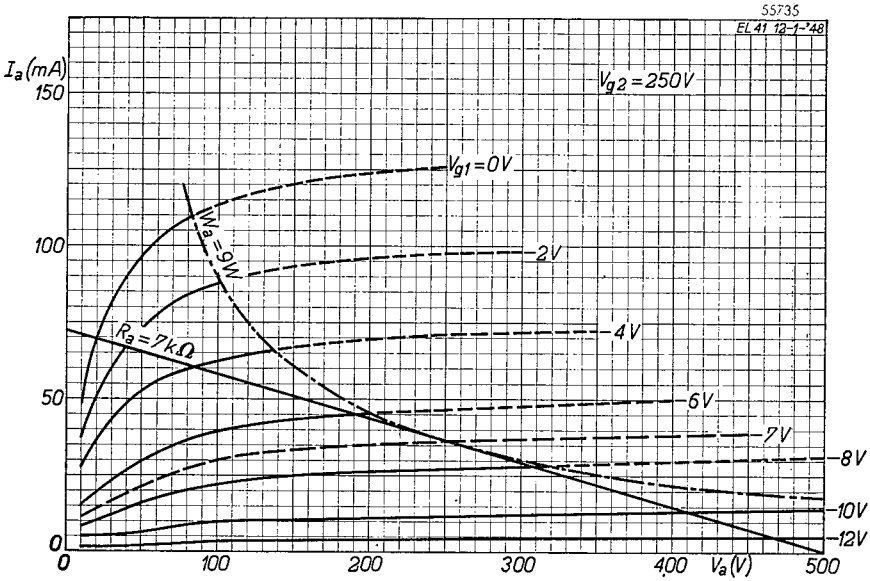

Fig. 5
 Anode current I_a as a function of the anode voltage V_a with the grid bias V_{g1} as parameter. Screen grid voltage $V_{g2}=250$ V. The straight characteristic is the load line for an anode resistance R_a of $7\text{ k}\Omega$. The dot-dash curve indicates the maximum permissible anode dissipation ($P_a=9\text{ W}$).

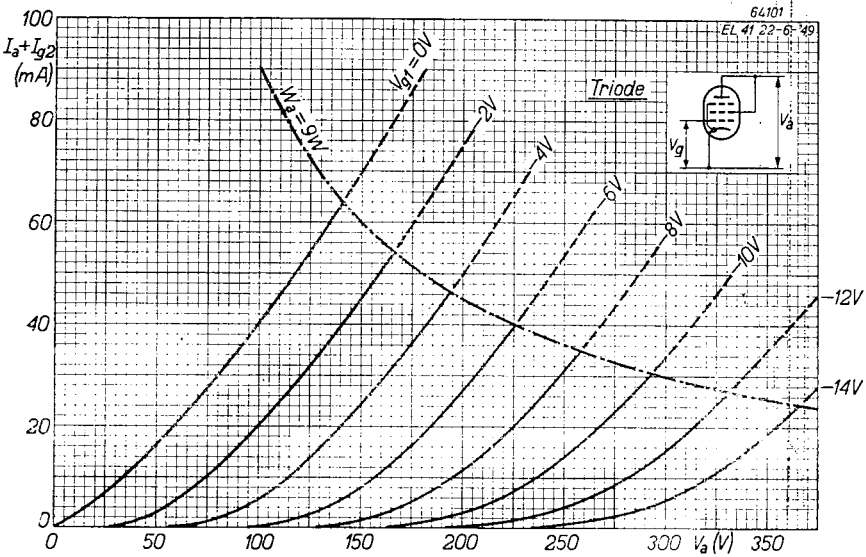

Fig. 6
 EL 41 connected as triode (screen grid connected to anode). Anode current I_a (including screen grid current) as function of the anode voltage. The dot-dash curve indicates the maximum permissible anode dissipation ($P_a=9\text{ W}$).

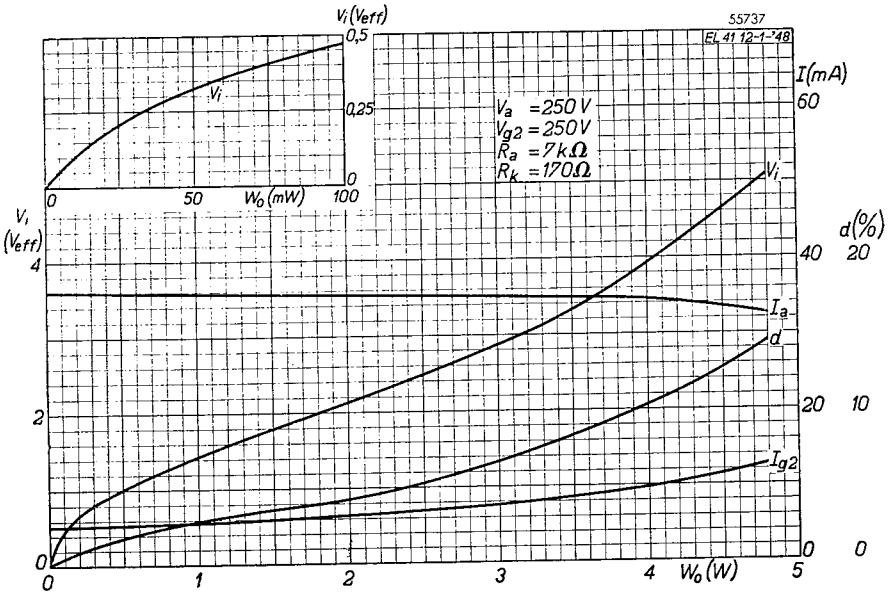

Fig. 7

Anode current I_a , screen grid current I_{g2} , distortion d and required input voltage V_i as functions of the output W_o . Upper-left inset : A.C. input voltage V_i as a function of the power output W_o for low values of W_o .

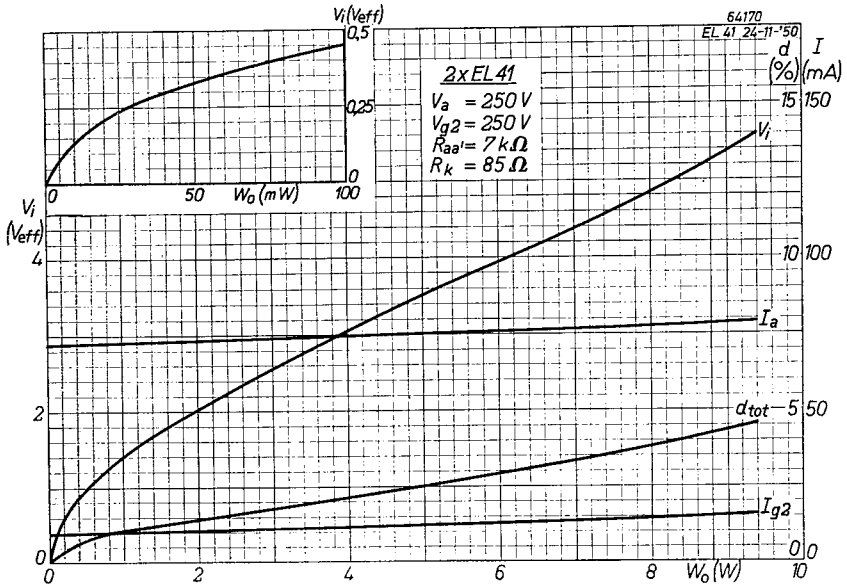

Fig. 8

As Fig. 7, for two EL 41 valves in Class A push-pull. I_a =total anode current, I_{g2} =total screen grid current, V_i =A.C. input voltage.

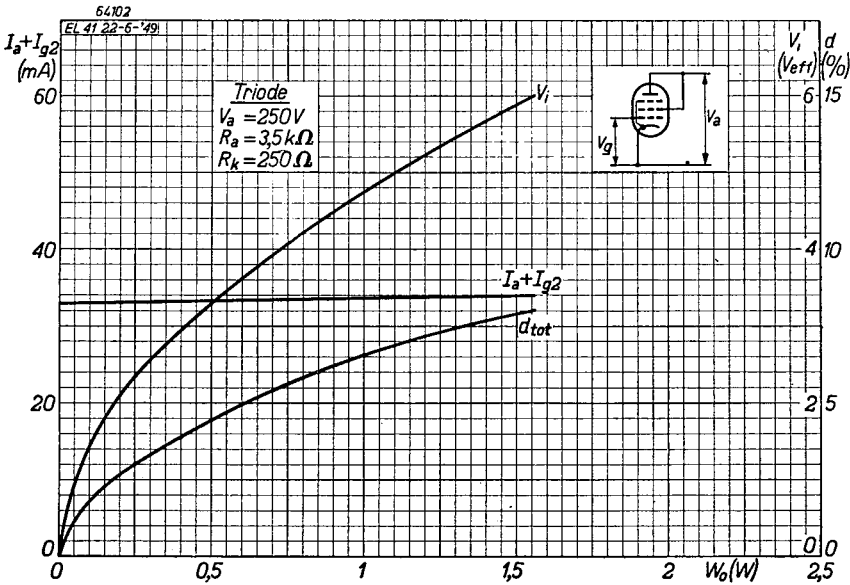

Fig. 9

As Fig. 7, for an EL 41 connected as a triode (screen grid connected to anode).

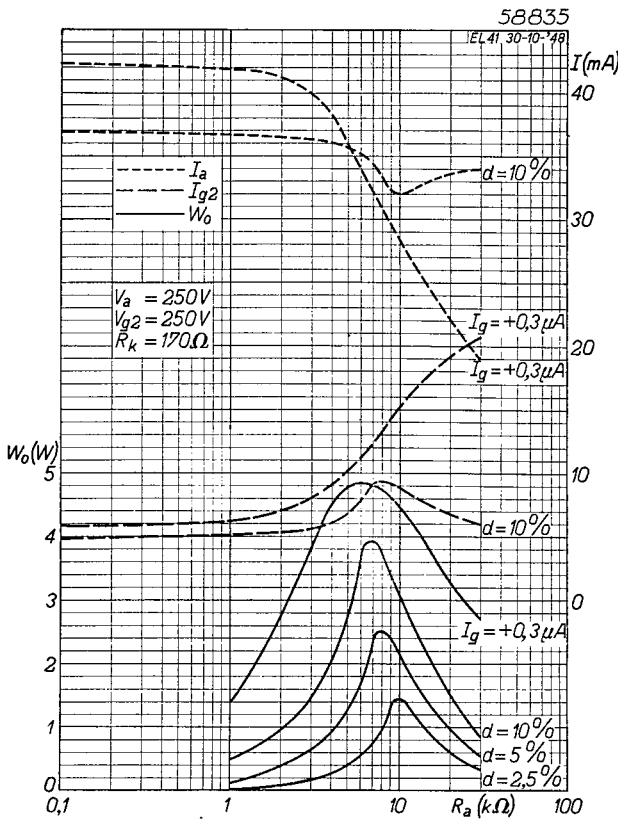

Fig. 10

Output power W_o of the EL 41 with $2\frac{1}{2}$, 5 and 10% distortion and at the grid current starting point ($I_{g1} = +0,3\mu A$), as a function of the anode load resistance (continuous curves). Also the anode current I_a (dotted lines) and screen grid current I_{g2} (long dashes) with 10% distortion and at the grid current starting point ($I_{g1} = +0,3\mu A$), as function of the anode-load resistance R_a .

EL 42

EL 42 Low-consumption output pentode

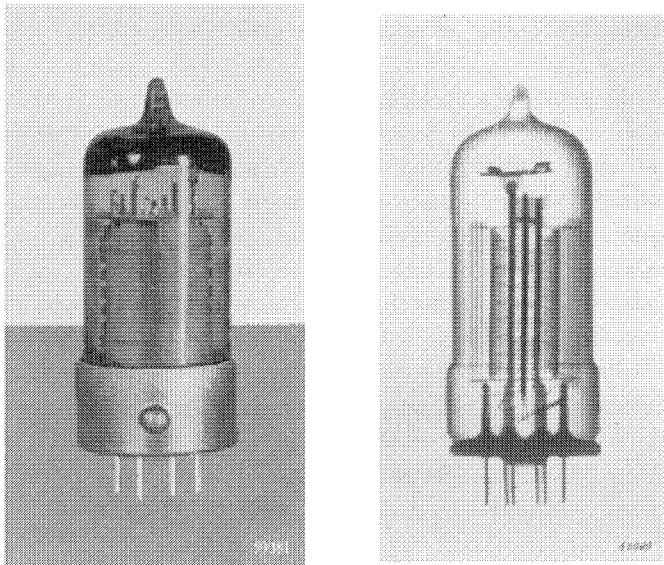

Fig. 1

Normal and X-ray photographs of the EL 42 (approximately actual size).

The EL 42 is an indirectly heated output valve intended primarily for use in receivers in cases where low current consumption is important. Every effort has been made to ensure the lowest possible consumption of heater current, which is, in effect, only 200 mA, the power required by the heater being 1.26 W. Notwithstanding the low consumption, the slope of this valve is quite good, viz. 3.2 mA/V, with adequate sensitivity (approx. 0.8 V_{RMS} A.C. grid voltage to produce an output of 50 mW).

As the EL 42 is employed mainly for car radio and vibrator-driven sets, the voltage source will usually be an accumulator, of which the voltage, in practice, is subject to considerable fluctuation; it is advisable, therefore, to arrange for a working point that will give, in absence of an input voltage, an average anode dissipation of 6 W when the supply voltage is 7 V. Variations in the voltage between 5.5 and 8 V will then be permissible without risk of under-running or overloading the valve. Further, the maximum permissible anode dissipation may then be allowed to exceed its limit by as much as 15% as a result of tolerances of the components in the circuit and in consequence of the automatic gain control. (see page 2).

The maximum output power of the individual EL 42 is 2.8 W with 225 V on anode and screen grid, at which level the grid input is 8 V_{RMS} . The EL 42 is also suitable for use in push-pull output stages; a Class A amplifier with anode and screen grid operating at 250 V, and with automatic bias, will deliver an output of 7 W with a distortion of 5.5 %.

In class B, the maximum output for the same anode potential is 6.5 W with 5% distortion, and, in this connection, the ECC 40 as phase inverter will be found very advantageous ; one of the triode systems of this valve is then used for that purpose, whilst the other can serve as rectifier to provide bias for the output valves.

As the amount of space in car-radio sets is usually restricted, the dimensions of the EL 42 have been kept at a minimum ; this valve is no larger than the pre-amplifier valves.

TECHNICAL DATA OF THE OUTPUT PENTODE EL 42

Heater data

Heating : indirect, A.C. or D.C., parallel feed

Heater voltage	V_f	=	6.3 V
Heater current	I_f	=	0.2 A

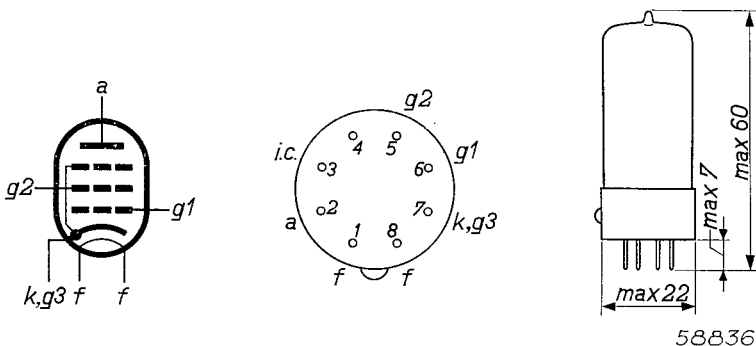

Fig. 2
Electrode arrangement, electrode connections and maximum dimensions in mm of the EL 42.

Capacitances (cold valve)

Input capacitance	C_{g1}	=	4.3 pF
Output capacitance	C_a	=	6.2 pF
Anode - control grid	C_{ag1}	<	0.2 pF
Control grid - heater	C_{g1f}	<	0.2 pF

EL 42

Operating characteristics of the EL 42 used as Class A output amplifier
(see Figs. 6 and 7)

Anode voltage	V_a	=	200	225	V
Screen grid voltage	V_{g2}	=	200	225	V
Cathode resistor	R_k	=	360	360	Ω
Anode current	I_a	=	22.5	26	mA
Screen grid current	I_{g2}	=	3.5	4.1	mA
Mutual conductance	S	=	3.2	3.2	mA/V
Internal resistance	R_i	=	90	90	k Ω
Amplification factor, screen grid with respect to control grid	μ_{g201}	=	11	11	
Matching resistance	R_a	=	9	9	k Ω
Output power	W_o	=	2.1	2.8	W
Total distortion	d_{tot}	=	11	12	%
A.C. grid voltage	$V_i(W_o=\text{max.})$	=	6.8	8.0	V_{RMS}
Sensitivity	$V_i(W_o=50 \text{ mW})$	=	0.8	0.75	V_{RMS}

Operating characteristics of two valves EL 42 as Class A push-pull amplifier
(see Figs. 8 and 9)

Anode voltage	V_a	=	200		V
Screen grid voltage	V_{g2}	=	200		V
Common cathode resistor	R_k	=	310		Ω
Matching resistance	R_{aa}	=	15		k Ω
A.C. grid voltage	V_i	=	0	0.75	9.6 V_{RMS}
Anode current	I_a	=	2×16	—	2×17 mA
Screen grid current	I_{g2}	=	2×2.6	—	2×5.6 mA
Output power	W_o	=	0	0.05	4.1 W
Total distortion	d_{tot}	=	—	—	5.5 %
Anode voltage	V_a	=	250		V
Screen grid voltage	V_{g2}	=	250		V
Common cathode resistor	R_k	=	310		Ω
Matching resistance	R_{aa}	=	15		k Ω
A.C. grid voltage	V_i	=	0	0.7	12.5 V_{RMS}
Anode current	I_a	=	2×20	—	2×21.5 mA
Screen grid current	I_{g2}	=	2×3.2	—	2×6.7 mA
Output power	W_o	=	0	0.05	7.0 W
Total distortion	d_{tot}	=	—	—	5.5 %

Operating characteristics of two valves EL 42 as Class B push-pull amplifier
(see Figs. 10 and 11)

Anode voltage	V_a	=	200	V
Screen grid voltage	V_{g2}	=	200	V
Control grid voltage	V_{g1}	=	-17	V
Matching resistance	R_{aa}	=	16	k Ω
A.C. grid voltage	V_i	=	0 1.5 12	V_{RMS}
Anode current	I_a	=	2×5 — 2×16	mA
Screen grid current	I_{g2}	=	2×0.8 — 2×4.6	mA
Output power	W_o	=	0 0.05 4.0	W
Total distortion	d_{tot}	=	— — 3.5	%
Anode voltage	V_a	=	250	V
Screen grid voltage	V_{g2}	=	250	V
Control grid voltage	V_{g1}	=	-22.5	V
Matching resistance	R_{aa}	=	16	k Ω
A.C. grid voltage	V_i	=	0 1.7 16	V_{RMS}
Anode current	I_a	=	2×5 — 2×20	mA
Screen grid current	I_{g2}	=	2×0.8 — 2×6.5	mA
Output power	W_o	=	0 0.05 6.5	W
Total distortion	d_{tot}	=	— — 5	%

Limiting values

Anode voltage when biased to cut-off	V_{a_o}	= max.	550	V
Anode voltage	V_a	= max.	300	V
Anode dissipation	W_a	= max.	6	W
Screen grid voltage, biased to cut-off	V_{g2_o}	= max.	550	V
Screen grid voltage	V_{g2}	= max.	300	V
Screen grid dissipation without input signal	$W_{g2}(V_i=0)$	= max.	1	W
Screen grid dissipation on full load	$W_{g2}(W_o=\text{max.})$	= max.	2	W
Cathode current	I_k	= max.	35	mA
Grid current starting point	$V_{g1}(I_{g1}=+0.3\mu A)$	= max.	-1.3	V
External resistance between control grid and cathode	R_{g1}	= max.	2	M Ω
External resistance between cathode and heater	R_{jk}	= max.	20	k Ω
Voltage between cathode and heater	V_{jk}	= max.	100	V

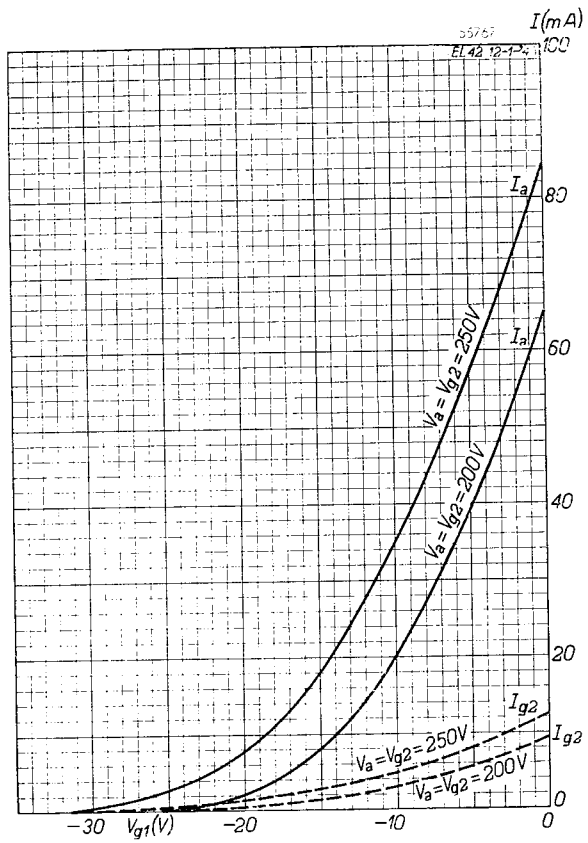

Fig. 3
Anode current I_a and screen grid current I_{g2}
as a function of the grid bias V_{g1} .

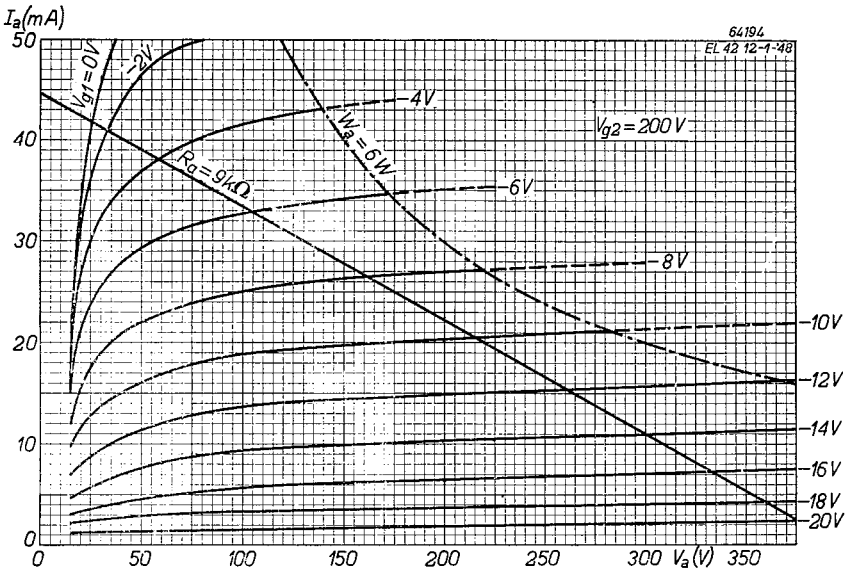

Fig. 4

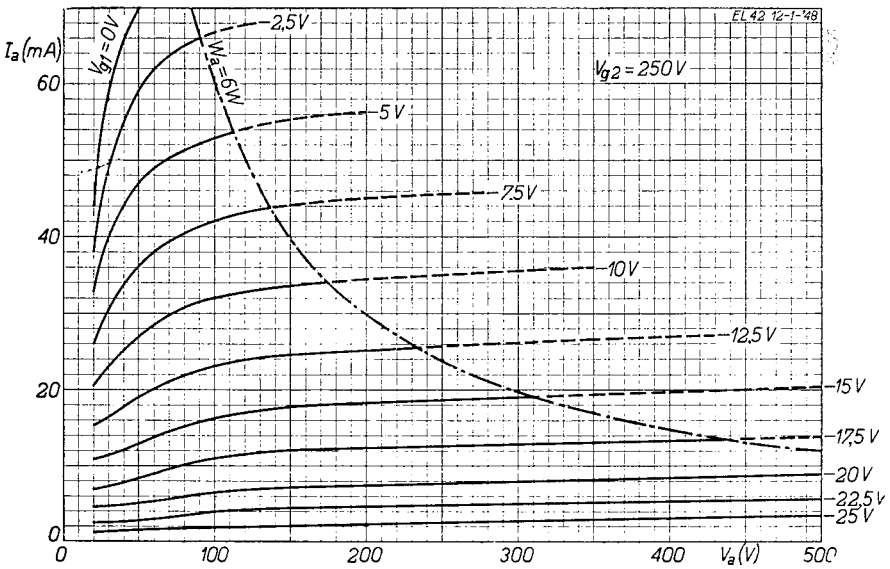

Fig. 5

Anode current I_a as a function of the anode voltage V_a with grid bias V_{g1} as parameter. The dot-dash line represents the maximum anode dissipation ($W_a = 6\text{ W}$). In Fig. 4 the screen grid voltage $V_{g2} = 200\text{ V}$; in Fig. 5 $V_{g2} = 250\text{ V}$.

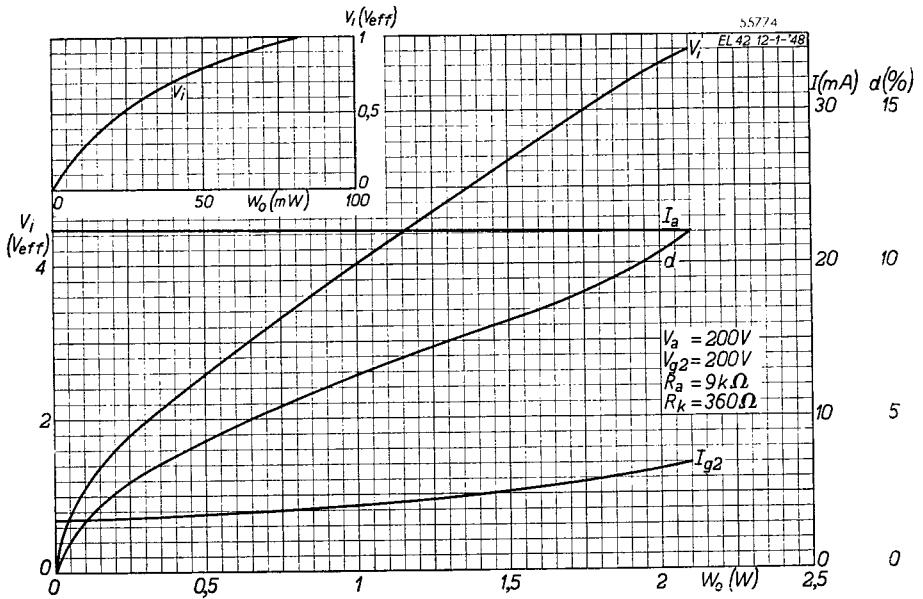

Fig. 6

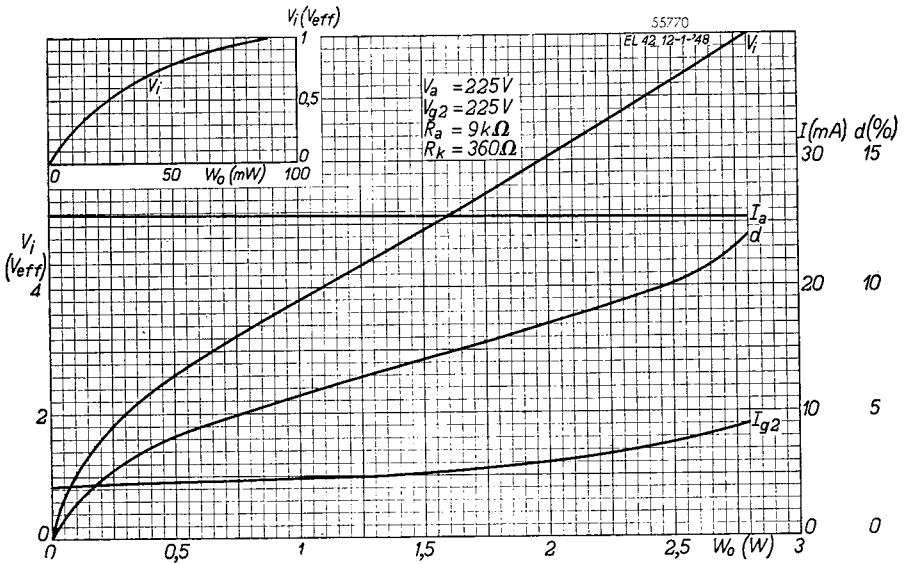

Fig. 7

Anode current I_a , screen grid current I_{g2} , distortion d and required A.C. grid voltage V_i , as functions of the output power W_o . Anode-load resistance $R_a = 9 \text{ k}\Omega$; cathode resistor $R_k = 360 \Omega$. In Fig. 6 both anode and screen grid voltage are 200 V; in Fig. 7, 225 V. In the inset the required A.C. grid voltage V_i is shown as a function of the output power W_o at low values of the latter.

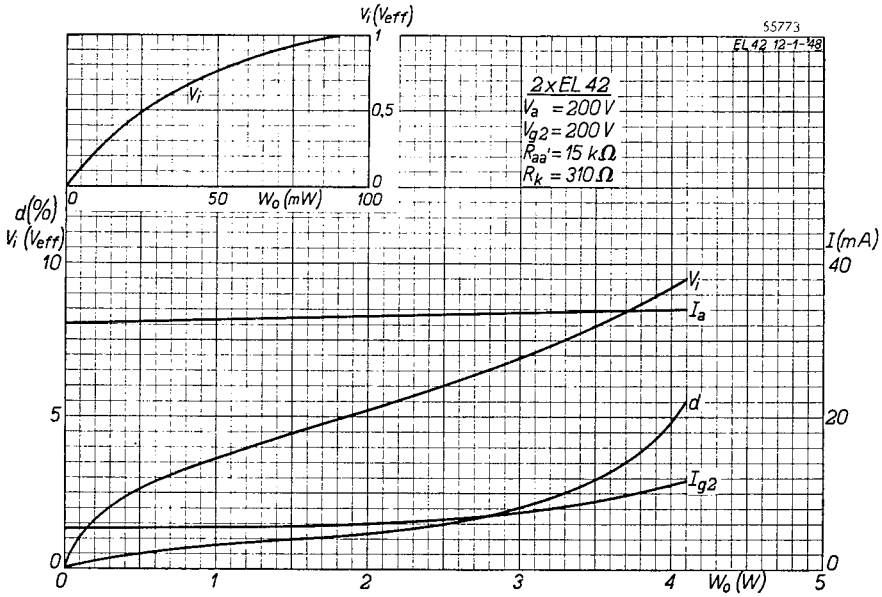

Fig. 8

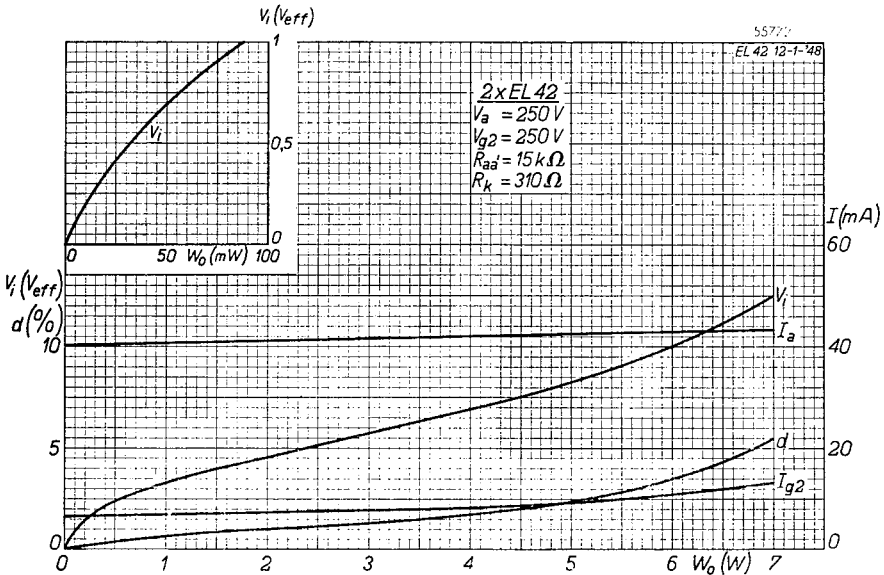

Fig. 9

As Fig. 6, but for 2 valves EL 42 in Class A push-pull, with $V_a = V_{g2} = 200\text{ V}$ (Fig. 8) and $V_a = V_{g2} = 250\text{ V}$ (Fig. 9). In both cases the load resistance between the two anodes is $15\text{ k}\Omega$ and the common bias resistor $310\ \Omega$.

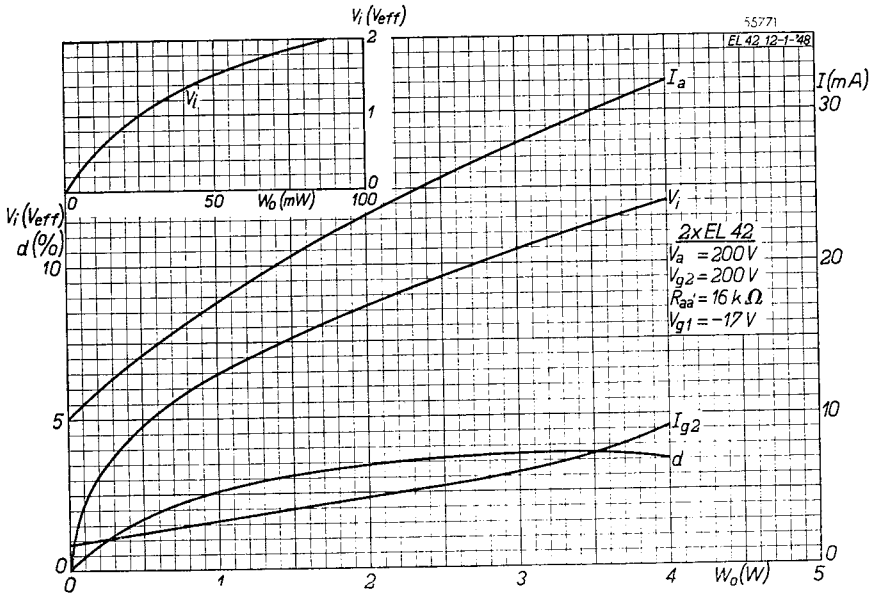

Fig. 10

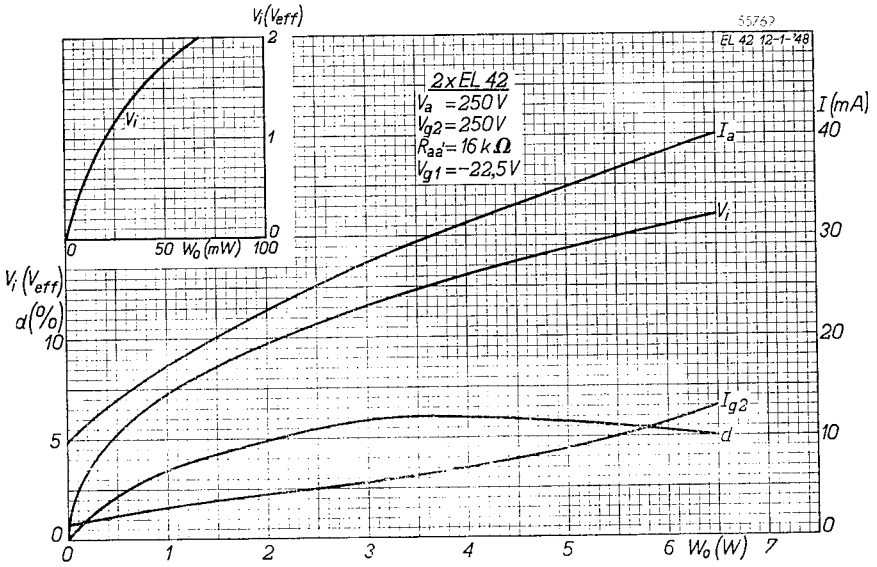

Fig. 11

As Fig. 6, but for 2 valves EL 42 in Class B push-pull, with $V_a = V_{g2} = 200 V$ (Fig. 10) and $V_a = V_{g2} = 250 V$ (Fig. 11). In both cases the load resistance between the two anodes is $16 k \Omega$. In Fig. 10 the grid bias is $V_{g1} = -17 V$, whilst in Fig. 11 $V_{g1} = -22.5 V$.

EZ 40 Full-wave rectifier

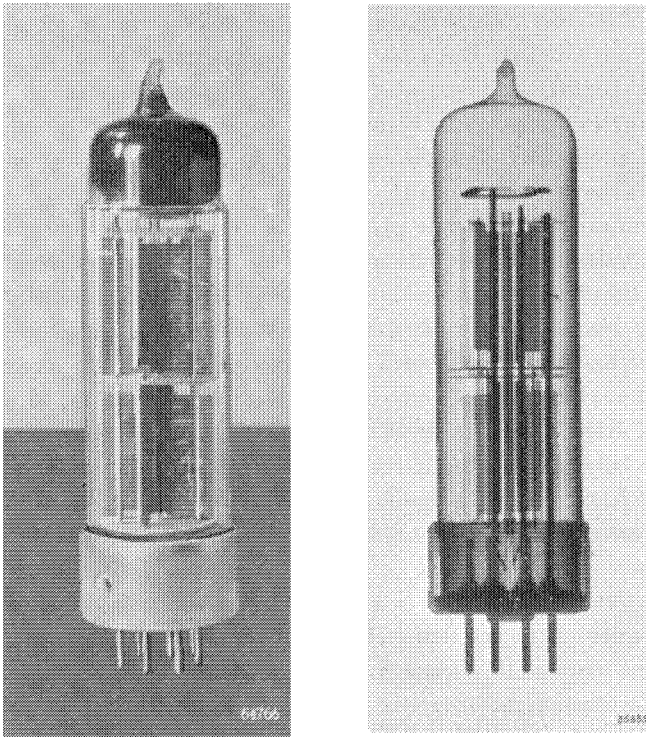

Fig. 1

Normal and X-ray photographs of the EZ 40 (approximately actual size).

The EZ 40 is an indirectly heated full-wave rectifier capable of delivering a maximum of 90 mA D.C. The maximum permissible alternating input voltage for each half of the valve is 350 V_{RMS} . For an appreciation of the advantages which indirectly heated rectifiers have over the directly heated type, the cathode warming-up time should be compared with that of the other valves in the receiver. In directly heated rectifiers, the filament reaches its working temperature very soon after the set has been switched on, so that the valve very soon supplies voltage. The other valves, however, take much longer to warm up and use no current in the meantime, with the result that the D.C. voltage increases until it equals the peak value of the applied alternating voltage. This voltage appears across the electrolytic condensers of the smoothing filter, for which reason these condensers must be capable of withstanding voltages of considerably higher value than the normal working voltage, to which value the D.C. voltage does not drop until the other valves, particularly the output valve, have warmed up sufficiently to pass current. The cathodes of indirectly heated rectifiers, on

EZ 40

the other hand, are so designed that their warming-up time is longer than that of the other valves in the set. Thus the use of indirectly heated rectifiers ensures that the H.T. voltage is supplied only after the other valves are in a condition to take current. Therefore, no surge occurs immediately after the set is switched on, and the electrolytic condensers need be capable of withstanding only the normal working voltage. Since the cost of these condensers is governed by the maximum permissible applied voltage, cheaper condensers can be used with indirectly heated rectifiers than with the directly heated types. In this connection it should be noted that the warming-up time of the EZ 40 is 35 seconds and that of the EL 41 22 seconds. By "warming-up time" is meant the time from the moment of closing the circuit to that at which half the ultimate current is delivered, or consumed.

The heater and cathode of the EZ 40 are so insulated from each other that a voltage having a peak value of 500 V can be applied between them without risk of breakdown. This value corresponds to the peak value of the maximum permissible alternating voltage. If, during use, the maximum permissible voltage is not exceeded, this will be the highest voltage to occur between heater and cathode, corresponding to the no-current condition, with maximum alternating input voltage. In view of this high insulation, the heater can be fed from the same transformer winding as the other heaters in the set, instead of from a separate winding with special insulation, as required for a directly heated rectifier.

In order to avoid sputtering in the EZ 40 (momentary flash-over between anode and cathode), a resistor should be included in each anode circuit. The minimum value for this resistor is dependent on the applied alternating voltage, and is given in the operating data at the end of this section. Part of the required resistance is usually already present in the form of the D.C. resistance of the mains transformer; in order to take this resistance into account, the following formula is employed :

$$R_t = R_s + n^2 R_p + R,$$

where : R_t is the minimum resistance required for each anode circuit,
 R_s the D.C. resistance of half the secondary of the mains transformer,
 R_p the resistance of the primary winding,
 n the turns ratio between the primary winding and half the secondary,
and R the minimum resistor to be added to each anode circuit to prevent sputtering.

In order to avoid any possible misunderstanding, it should be added that the previously mentioned maximum permissible voltage of 350 V_{RMS} is the voltage on the secondary of the mains transformer in the no-load condition.

TECHNICAL DATA OF THE FULL-WAVE RECTIFIER EZ 40

Heater data

Heating: indirect, A.C. or D.C., parallel feed

Heater voltage V_f = 6.3 V

Heater current I_f = 0.6 A

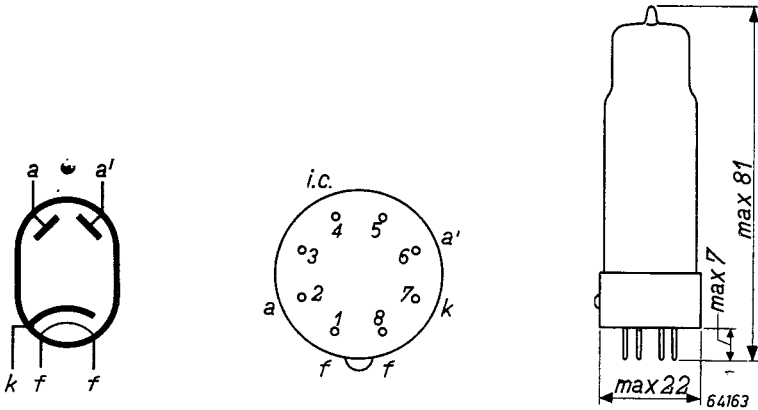

Fig. 2

Electrode arrangement, electrode connections and dimensions in mm of the EZ 40.

Operating and limiting values

Transformer voltage	V_{tr}	=	2×250	2×275	V_{RMS}
Direct current output	I_o	=	max. 90	max. 90	mA
Anode series resistance	R_t	=	min. 2×125	min. 2×175	Ω
First capacitor of smoothing filter	C_{fil}	=	max. 50	max. 50	μF
Peak voltage between cathode and heater	V_{fk}	=	max. 500	max. 500	V

Transformer voltage	V_{tr}	=	2×300	2×350^1	V_{RMS}
Direct current output	I_o	=	max. 90	max. 90	mA
Anode series resistance	R_t	=	min. 2×215	min. 2×300	Ω
First capacitor of smoothing filter	C_{fil}	=	max. 50	max. 50	μF
Peak voltage between cathode and heater	V_{fk}	=	max. 500	max. 500	V

¹⁾ Max. permissible transformer voltage.

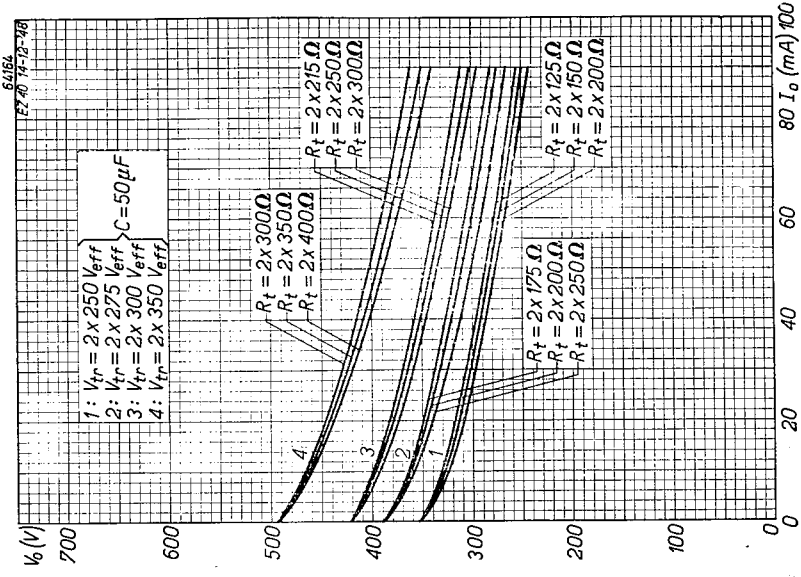

Fig. 4
 Load characteristic (D.C. output voltage V_o as a function of the D.C. output current I_o) of the EZ 40, for various values of the transformer voltage V_{tr} and different values of the D.C. resistance R_t in each anode

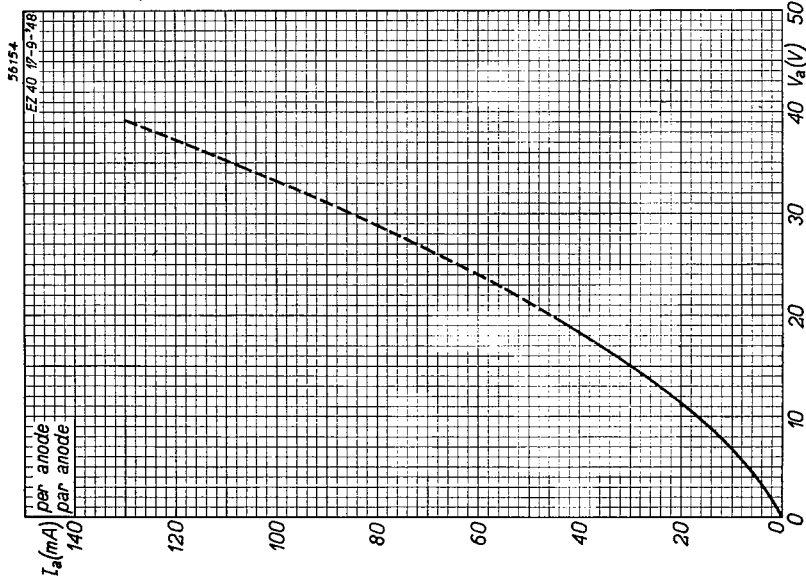

Fig. 3
 Anode current (I_a) of the EZ 40 as a function of the applied D.C. voltage (V_a); since the maximum permissible current per anode is 45 mA, the curve above this value is drawn as a dotted line.

EZ 41 Full-wave rectifier

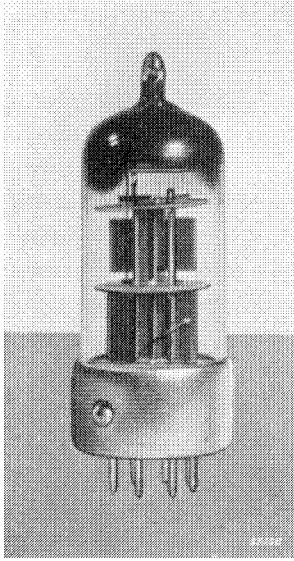

Fig. 1
The rectifier EZ 41 (about
actual size).

The EZ 41 is an indirectly heated, high-vacuum, full-wave rectifier which is specially designed for car radio and other receivers operating in conjunction with a single vibrator. The EZ 41 is used to rectify the alternating voltage supplied by the vibrator. In view of the fact that receivers of the type mentioned are usually designed for low current consumption, the EZ 41 is capable of rectifying current only up to 60 mA; the heater current of the valve is consequently relatively low, viz: 0.4 A. The maximum permissible alternating voltage to be rectified by the EZ 41 is $2 \times 250 V_{RMS}$. Since the heater voltage of the EZ 41 used in receivers mentioned previously is generally obtained from the same source as that for the heaters of the other valves in the set (an accumulator), the heater and cathode must be well insulated from each other. Thus a maximum voltage of 350 V is permissible between these electrodes.

In order to avoid sputtering (momentary flash-over between anode and cathode), a resistor must be included in each of the anode leads of the EZ 41; appropriate values for these resistors are given in the following data. For further particulars concerning this essential resistance, reference can be made to the description of the rectifier EZ 40.

TECHNICAL DATA OF THE FULL-WAVE RECTIFIER EZ 41

Heater data

Heating: indirect, A.C. or D.C., parallel feed

Heater voltage	V_f	=	6.3 V
Heater current	I_f	=	0.4 A

Limiting values

Transformer voltage	V_{tr}	= max.	$2 \times 250 V_{RMS}$
Direct-current output	I_o	= max.	60 mA
Peak voltage between heater and cathode	V_{fk}	= max.	350 V
First capacitor of the smoothing filter	C_{filt}	= max.	8 32 μF
Anode series resistance	R_i	= min.	2×150 $2 \times 300 \Omega$

EZ 41

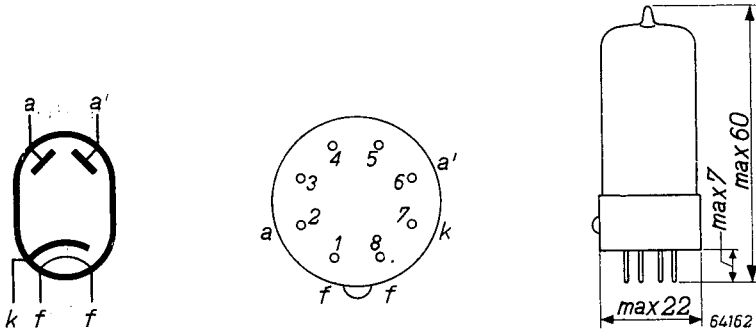

Fig. 2
Electrode arrangement, electrode connections and dimensions in mm of the EZ 41.

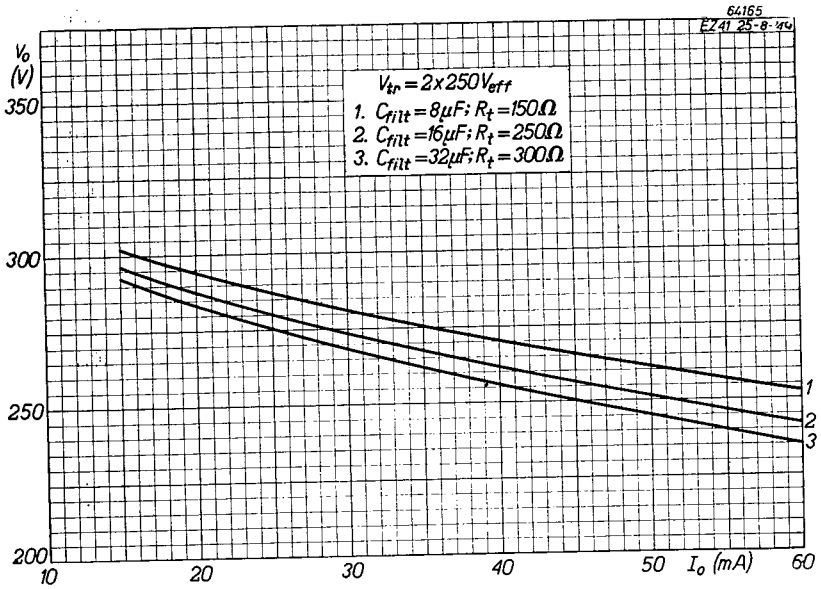

Fig. 3
Load characteristics of the EZ 41; direct-voltage output (V_o) as a function of the direct-current output (I_o) for various values of the anode series resistance.

I. 5-valve A.C. superheterodyne receiving circuits using two valves EAF 42

Introduction

The following Rimlock type valves are employed in each model:

ECH 42, or ECH 41, as triode-hexode frequency changer,

EAF 42 as A.G.C. diode and I.F. amplifier,

EAF 42 as detector diode and A.F. amplifier,

EL 41 as output valve,

AZ 41 as rectifier.

These circuits are designed chiefly for simplicity, although not at the expense of selectivity or sensitivity.

For the frequency changer there is a choice of two triode-hexodes: the ECH 42 of which the slope is $750 \mu\text{A}/\text{V}$, and the ECH 41 with a slope of $500 \mu\text{A}/\text{V}$, but in view of its much better characteristics, the former is usually preferred. Owing to the fact that one diode-pentode EAF 42 is used for A.F. amplification and another for I.F. amplification, the gain is sufficient to ensure high over-all sensitivity. One of the advantages of this arrangement is that the diodes for A.G.C. and detection are housed in separate valves, so avoiding any extra parasitic coupling between the two circuits of the last I.F. transformer, to which these diodes are usually connected. Moreover, it allows the designer greater freedom in selecting a circuit.

Provided that I.F. transformers having a quality factor $Q=140$ are used, and that both the anode of the I.F. valve and the detector diode are connected to tappings ($t=0.7$) on the circuits, it is possible to build a receiver with an over-all sensitivity of $1.2 \mu\text{V}$. Such a receiver has certain disadvantages, however, viz :

1. the noise level at the grid of the frequency changer is approximately equal to that of the wanted signal;
2. the high A.F. amplification might give rise to hum and microphony;
3. the A.G.C. curve is very unsatisfactory, and the output valve delivers maximum power before the A.G.C. has come into operation;
4. very high sensitivity greatly increases the risk of instability due to unwanted coupling in the receiver.

There are two methods of overcoming these difficulties:

- a) by using negative feedback from the output valve to the grid of the A.F. pre-amplifier valve, or
- b) by connecting the A.F. valve EAF 42 as a triode.

The latter method is naturally the more economical (at least 3 resistors and 1 capacitor are saved), but the resultant distortion is greater than in method (a). The circuits relevant to both methods are described in this chapter.

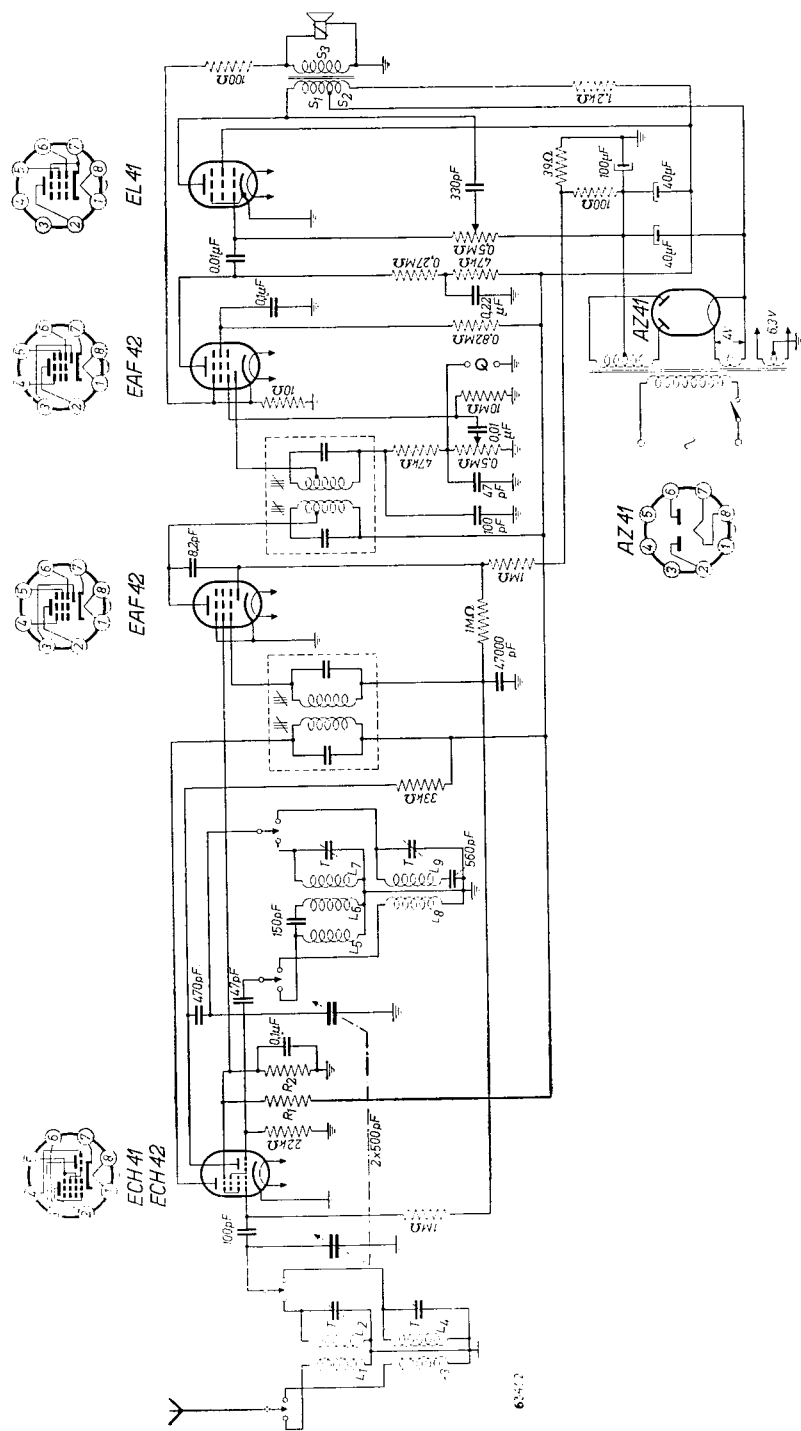

Fig. 1. Circuit of a 5-valve A.C. receiver. With ECH 41: $R_1 = 18\text{ k}\Omega$, $R_2 = 27\text{ k}\Omega$; with ECH 42: $R_1 = 22\text{ k}\Omega$, $R_2 = 27\text{ k}\Omega$.

DESCRIPTION OF THE CIRCUITS

The aerial coupling

For the sake of simplicity, the circuit shown in Fig. 1 is designed for two wave-bands :

1. medium waves (approx. 200 - 600 m)
2. short waves (approx. 15 - 50 m).

The modifications necessary to make the receiver suitable for more, or other, wave-bands will not materially affect the circuit. The change-over from one wave-band to the other is effected by bringing different coils into operation.

The aerial coupling is based on the high-inductance principle ; the self inductance of the aerial coil is high compared with that of the tuning coil, and the resonant frequency of the combination of aerial-coupling coil and aerial capacitance is low in relation to the tuning frequency.

This provides an aerial coupling of which the performance is almost independent of the frequency. In this model the average aerial gain across the aerial coupling is 3.5.

The mixing stage

The ECH 42 or the ECH 41 may be used as frequency changer; both these valves are triode-hexodes in which the modulator grid (g_3) of the hexode section is connected internally to the triode grid. The oscillator tuning circuit is incorporated in the anode lead of the triode; parallel feed is employed for the anode using a resistor of 33 k Ω . This goes a long way towards ensuring a constant oscillator voltage throughout the wave-band.

In order that sufficient oscillator voltage remains available at the end of the short-wave band, the coupling of the oscillator coils should be fairly tight; on the other hand, since excessive frequency displacement is then inevitable when control is applied to the valve, and, moreover, since the likelihood of over-oscillation on 15 m is then also greater, a grid leak not exceeding about 20 k Ω should be used.

To secure a relatively constant oscillator voltage with less tight coupling of the coils, an extra coil (L_5) is connected between the coupling coil and the grid capacitor to increase the voltage gain at the end of the wave-band.

The frequency at which maximum voltage gain occurs is governed mainly by the combination of the extra coil and the coupling capacitance; it is usually advisable to ensure that the resonant frequency of this combination lies outside the range of frequencies of the oscillator.

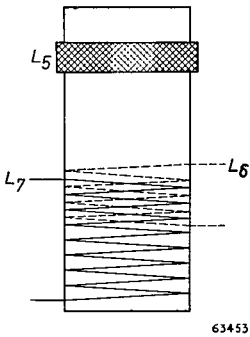

Fig. 2. Diagram of short-wave oscillator coil. In the receiver model designed for 15-50 m:
 $L_5 = 26$ turns,
 $L_6 = 8$ turns,
 $L_7 = 16$ turns.

With the extra coil, a coupling ratio $t=M/L=\frac{\text{A.C. grid voltage}}{\text{A.C. anode voltage}}$ of only 0.25 is adequate; without it, this ratio would have to be about 0.45. Fig. 2 shows an oscillator coil of the kind described. In a laboratory model, maximum frequency drift at approx. 15 m was found to be only 1.1 kc/s.

At an oscillator voltage of about 8 V_{RMS} (which corresponds to a grid current of 350 μA through the 22 k Ω grid leak) the conversion slope of the ECH 42 is about 750 $\mu\text{A/V}$. If I.F. transformers with a circuit quality factor of $Q=140$ are used, a conversion gain of roughly 125 is obtainable; under similar conditions the conversion gain of the ECH 41 is approx. 90, the maximum conversion slope of this valve being 500 $\mu\text{A/V}$. In the medium wave-band the coupling ratio M/L should be about 0.18 for the ECH 42, and about 0.26 for the ECH 41.

To avoid the adverse effects on the internal resistance of secondary emission it is advisable to feed the screen grids by means of a potentiometer which, incidentally, can then also supply the screen grid voltage for the I.F. valve. For the ECH 42 the potentiometer resistor values R_1-R_2 are 22 and 27 k Ω respectively, and for the ECH 41, 18 and 27 k Ω .

The I.F. amplifier stage

The intermediate frequency of the circuit is 452 kc/s; the most appropriate frequency naturally depends on local conditions, but any alteration in this respect will not affect the circuit arrangement in the least.

Since the diodes are connected to the circuits of the second I.F. transformer by means of tapplings ($t=0.7$), the effects of diode damping are greatly reduced. Coupling between these circuits is more than critical ($k/\delta=1.1$) so that, taking into account the diode damping, the actual circuit coupling is just about critical. In the uncontrolled condition, the over-all amplification of the I.F. stage is then approximately 85.

To reduce the effects of fluctuations in the input capacitance due to the A.G.C. it is also possible to connect the control grid of the EAF 42 to a tapping on the preceding transformer, although this naturally also reduces the sensitivity to some extent.

It should be pointed out that, in order to avoid instability due to feed-back, it may often be found necessary to fit a metal screening plate between the control grid and anode connections under the valveholder.

Detection and A.G.C.

As already mentioned in the introduction, the diodes for detection and A.G.C. are contained in two separate valves, both of the type EAF 42. In the circuit illustrated in Fig. 1, the diode in the A.F. valve functions as detector, and that of the I.F. valve as A.G.C. diode. The delay voltage for the A.G.C., derived from the negative side of the power section and supplied through a potentiometer comprising two resistors (39 $\Omega+100 \Omega$), is such that the A.G.C. does not come into operation until the EL 41 output valve

is almost fully loaded. This delay voltage also provides the grid bias for the frequency changer and for the I.F. valve.

In order to prevent excessive diode damping when a gramophone pick-up is to be used a 47 kΩ resistor is connected in series with the 0.5 MΩ load resistor

The A.F. amplifier and output stages

The A.F. signal is taken from an 0.5 MΩ potentiometer and is applied to the control grid of the EAF 42 through a coupling capacitor of 0.01 μF. The EAF 42 is capable of giving an amplification of 80, but this is far too high for the circuit in question and would result in microphony in the absence of special precautions to prevent this. The reserve gain is utilized to provide strong feedback: the secondary output transformer voltage is returned, via a 100 Ω resistor, to a 10 Ω resistor, in the cathode circuit of the A.F. amplifier valve, and this voltage, corresponding with a feedback factor of 10, reduces the total effective amplification of the A.F. stage to a factor of about 8.

In view of the fact that the value of the grid leak of the EAF 42 is very high (10 MΩ), no separate grid bias is needed for this valve.

The working point of the EL 41 is so placed that this valve only delivers maximum output when a strong signal is received. If the valve were to operate at its appropriate working point in the absence of any signal, or on weak signals, the anode and screen grid currents of the frequency changer and the I.F. valve would drop almost to zero value on an increasing signal, thus displacing the working point of this valve to such an extent that the anode dissipation would exceed the maximum permissible limit.

This effect is aggravated by the voltage drop in the 1200 Ω smoothing resistor and the corresponding increase in screen grid voltage. The appropriate working point for the EL 41 can be computed in the following manner. Let I_1 be the constant component of the total cathode current, I_2 the decrease in current in the ECH 42 (ECH 41) + EAF 42, and I_3 the increase in screen grid and anode current. Grid bias is provided by a common resistor R in the negative line. In the absence of modulation, or when only weak signals are being received and the A.G.C. is still inoperative, the following formulae apply:

$$I_{tot} = I_1 + I_2 \quad \text{and} \quad V_{g1} = -(I_1 + I_2)R.$$

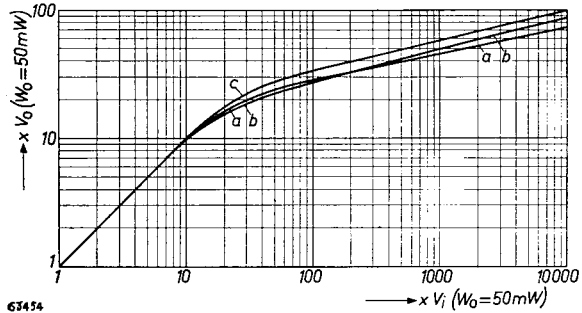

Fig. 3. A.G.C. characteristic of a receiver:
a. with the circuit shown in Fig. 1;
b. with the circuit shown in Fig. 4;
c. with the A.F. valve EAF 42 connected as triode.

When the A.G.C. comes into operation:

$$I_{tot} = I_1 + I_3 \text{ and } V_{g1} = -(I_1 + I_3)R.$$

The variation in the grid bias of the EL 41 is therefore :

$$\Delta V_{g1} = (I_1 + I_2)R - (I_1 + I_3)R = (I_2 - I_3)R.$$

It is known that:

$$I_3 = S \Delta V_{g1} = S(I_2 - I_3)R = SRI_2 - SRI_3;$$

hence:

$$I_3 = \frac{SR}{1 + SR} I_2.$$

When a resistor of about 139Ω is used for biasing purposes, the anode current of the EL 41 rises to the following extent :

$$I_3 = \frac{9 \cdot 10^{-3} \times 139}{1 + 9 \cdot 10^{-3} \times 139} 10 = \text{approx. } 5.5 \text{ mA.}$$

In the no-signal condition, or when only weak signals are received, the EL 41 takes an anode current of about 30 mA, corresponding to a grid bias of roughly -7.5 V . The output valve is not then fully loaded, which is immaterial, since, in view of the adverse noise-to-signal ratio under such conditions, there is no point in reproducing weak signals at full volume.

Feedback

Feedback can be effected in various ways; for example, the amount returned can be made dependent on the setting of the volume control: if the 10 ohm resistor is transferred from the cathode circuit to the bottom end of the potentiometer (see Fig. 4), the amount of the feedback is small when the po-

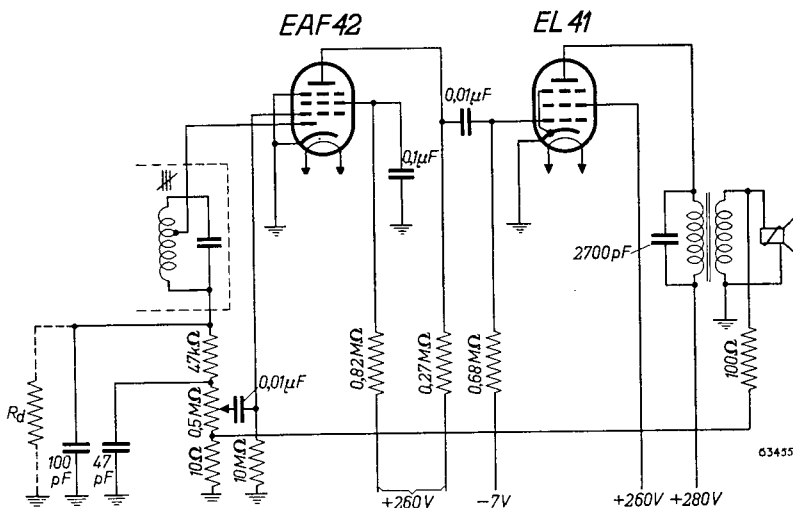

Fig. 4. Modified feedback circuit: the amount of feedback is governed by the setting of the volume control.

tentiometer is at its maximum. This will be clearly seen on considering the network formed by the 0.5 MΩ potentiometer (volume control), the 47 kΩ series resistor and the diode damping, which works out at roughly 100 kΩ on weak signals, or about 250 kΩ on strong signals.

When weak signals are received with the volume control at maximum, feedback amounting to a factor of

$$\frac{100 + 47}{100 + 47 + 500} = 0.225$$

is returned to the grid of the A.F. valve (on stronger signals about 0.37). When the volume control is turned back to approx. one third of its total

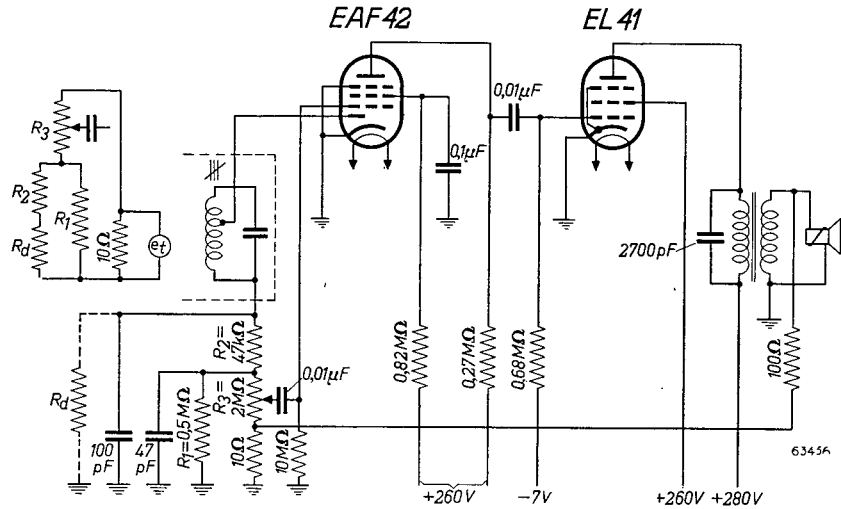

Fig. 5. Modified version of the circuit shown in Fig. 4.

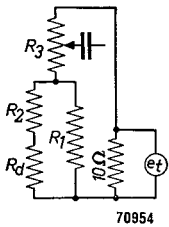

Fig. 6. Equivalent circuit of the feedback arrangement shown in Fig. 5.

resistance, the factor increases to :

$$\frac{250 + 47 + 2/3 \times 500}{250 + 47 + 500} = \text{approx. } 0.8.$$

The A.G.C. curve of this circuit (b in Fig. 3) is rather more satisfactory than that of the original circuit shown in Fig. 1, although there is one drawback in that the feedback voltage, which produces an alternating current in anti-phase with the existing A.F. voltage across the diode load resistor, adversely affects the A.C. resistance of the diode circuit. This means that the $R_{A.C.}/R_{D.C.}$ ratio is reduced and that distortion at high modulation peaks will be increased. This can be avoided, however, by using the circuit shown in Fig. 5, where the volume control (2 MΩ), in series with the 10 Ω feedback resistor, is connected in parallel with the diode load resistor.

In Fig. 6, which shows the equivalent circuit for the arrangement in Fig. 5, it is seen that the feedback voltage is divided between the potentiometer R_3 (dependent on the setting of the volume control) in series with the parallel network R_1 and $R_2 + R_d$ (diode-damping). The equivalent resistance of R_1 , R_2 and R_d is $0.115 \text{ M}\Omega$ for weak signals, and $0.23 \text{ M}\Omega$ for strong signals. When the volume control is turned up fully, the grid of the A.F. valve receives $\frac{0.115}{2.115} = 0.054 \times$ the feedback voltage on weak signals, and on strong signals $\frac{0.23}{2.23} = 0.103 \times$ the feedback voltage.

When the volume control is turned back to one third of its total resistance, the respective factors are 0.68 and 0.74.

In this circuit, then, feedback is still more dependent on the volume control than in the circuit shown in Fig. 4.

The power section

This is of the conventional type. A mains transformer delivers the H.T. voltage to a full-wave rectifying valve; D.C. is derived from the filament, and smoothed in the usual way by two electrolytic capacitors and a 1200 ohm resistor. The anode voltage for the output valve EL 41 is taken from the first capacitor and is applied to a tapping on the primary of the output transformer, the bottom end of this winding being connected to the second electrolytic capacitor through the smoothing resistor mentioned above.

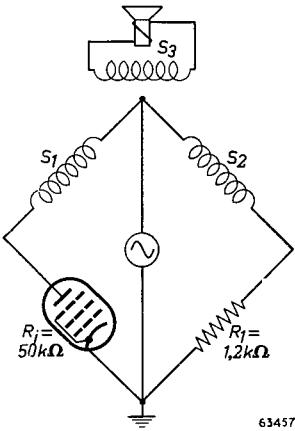

Fig. 7. Equivalent diagram of the hum-compensation circuit.

In this way a ripple voltage is introduced at the lower end of the output transformer which is of opposite phase to the ripple voltage in the rest of the primary, the one thus counteracting the other. Provided that the extra winding contains the appropriate number of turns, it is even possible to compensate to some extent the ripple voltage originating from the preceding stages.

The equivalent diagram of the hum-compensation circuit is shown in Fig. 7, to illustrate the method of determining the correct position for the tapping on the primary of the output transformer. If the impedance of the last smoothing capacitor is low compared with that of the 1200 ohm resistor, and the A.C. voltage across this capacitor is also low, the 1200 ohm resistor may be regarded as being earthed as far as the A.C. voltage is concerned. The output transformer, combined with the power section for the output valve, can then be represented by a Wheatstone bridge in which the ripple voltage across the first smoothing capacitor is regarded as the voltage source, and the secondary transformer winding as the zero indicator.

No A.C. voltage will occur across the terminals of the secondary winding when

$$\frac{S_1}{S_2} = \frac{R_i}{R_1},$$

in which S_1 = number of turns of the primary of the output transformer, without hum-compensation winding;

S_2 = number of turns of the hum-compensation winding;

R_i = internal resistance of the output valve;

R_1 = the value of the smoothing resistor.

For the circuit in question:

$$\frac{S_1}{S_2} = \frac{50,000}{1200} = \text{approx. } 41.5.$$

In order to obtain the best possible results it is advisable first to make an experimental model of the transformer, with more turns for the hum-compensation winding than would be necessary according to the calculation. The exact number of turns, which is more easily determined experimentally, may differ slightly from the number calculated, owing, amongst other things, to the effects of phase displacement and to the extra ripple compensation originating in other parts of the receiver

MEASURED VALUES
Voltages and currents

Without A.G.C. | With A.G.C.

Supply voltage at the first smoothing capacitor	278 V	280 V
Supply voltage at the second smoothing capacitor	261 V	263 V
Anode voltage EL 41	258 V	260 V

ECH 42 - ECH 41 - frequency changer

Anode current, hexode part	2.8 mA	—
Anode current, triode part	4 mA	4 mA

EAF 42 - I.F. amplifying valve

Anode current	4.5 mA	—
Screen grid current of the ECH 42/41 and EAF 42 + potentiometer current	9.2 mA	6.5 mA

EAF 42 - A.F. amplifying valve

Anode current	0.75 mA	0.75 mA
Screen grid current	0.25 mA	0.25 mA

EL 41 - output valve

Anode current	30 mA	35.5 mA
Screen grid current	2.8 mA	4.3 mA

The oscillator voltage of the ECH 42 or ECH 41 is about $8 V_{RMS}$ with approx. $350 \mu A$ direct current through the $22 k\Omega$ grid leak.

Sensitivity

For an output of:	50 mW	500 mW
At the control grid of the EL 41	0.33 V_{RMS}	1.2 V_{RMS}
At the detector diode (A.F.)	41 mV_{RMS}	131 mV_{RMS}
At the detector diode (I.F.)	200 mV_{RMS}	560 mV_{RMS}
At the control grid of the EAF 42 (I.F.)	2.6 mV_{RMS}	7.2 mV_{RMS}
At the control grid of the ECH 41	35 μV_{RMS}	95 μV_{RMS}
At the control grid of the ECH 42	22 μV_{RMS}	66 μV_{RMS}
At the aerial (ECH 41). . . approx	10 μV_{RMS}	30 μV_{RMS}
At the aerial (ECH 42) . . . approx.	7 μV_{RMS}	22 μV_{RMS}

Selectivity, measured at 1000 kc/s

Attenuation: 1 : 10 when the receiver is detuned ± 4.5 kc/s
1 : 100 when the receiver is detuned ± 9.5 kc/s
1 : 1000 when the receiver is detuned ± 15.5 kc/s.

This detuning amounts to ± 5 kc/s, ± 9.75 kc/s and ± 17 kc/s for the I.F. stage.

The A.F. pentode connected as a triode

The circuit can be simplified by connecting the EAF 42 - A.F. pentode as a triode. This valve then provides a gain of 15, giving an overall sensitivity of about $6 \mu\text{V}$. In view of the fact that the circuit is then less sensitive to ripple, no separate hum-compensation winding is needed in the output transformer.

The A.G.C. curve for this circuit is shown in Fig. 3 (curve c); the sensitivity values are as follows:

Sensitivity (triode connection)

For an output of:

	50 mW	500 mW
At the control grid of the EL 41	0.33 V_{RMS}	1.2 V_{RMS}
At the diode detector (A.F.)	22 mV_{RMS}	80 mV_{RMS}
At the diode detector (I.F.)	121 mV_{RMS}	320 mV_{RMS}
At the control grid of the EAF 42 (I.F.)	1.56 mV_{RMS}	4.13 mV_{RMS}
At the control grid of the ECH 41	18.1 μV_{RMS}	48 μV_{RMS}
At the control grid of the ECH 42	14 μV_{RMS}	35 μV_{RMS}
At the aerial (ECH 41) approx.	6 μV_{RMS}	18 μV_{RMS}
At the aerial (ECH 42) approx.	5 μV_{RMS}	13 μV_{RMS}

In a laboratory model receiver the ripple voltage across the secondary winding of the output transformer was not more than $10 mV_{RMS}$

Note

The pins of the EL 41 and AZ 41 indicated in the circuits by hatched circles should not be connected.

II. A superhet with 4 Rimlock valves and separate power units for battery and A.C. mains

Introduction

This receiver is very easily adapted to either A.C. mains, or a 6 V battery, as the power units are interchangeable.

The circuit is designed for two wave-bands :

medium waves : 180 - 590 m,

short waves : 15 - 50 m,

but it is, of course, a fairly simple matter to adapt it for other wave-bands.

The following Rimlock type valves are employed in the receiving section:

ECH 42 - triode-hexode frequency changer,

EF 41 - I.F. amplifying pentode,

EBC 41 - duodiode-A.F. triode,

EL 41 - 9 W output pentode.

DESCRIPTION OF THE CIRCUIT

The aerial coupling and mixing stage

The aerial coupling and the circuit of the mixing stage are identical with those shown in diagram I: here, too, a circuit connected in parallel with the short-wave oscillator coupling coil is used, so that a moderate amount of coupling yields a fairly constant oscillator voltage over the entire short wave-band.

The I.F. amplifying stage

Apart from the fact that an EF 41 pentode with a slope of 2.2 mA/V is used as amplifying valve, the I.F. stage is identical with that shown in diagram I.

Detection and A.G.C.

The anode of the EF 41 is connected, through a coil tapping of 0.7, to the primary circuit of the last I.F. transformer. This tap is also connected to the A.G.C. diode, which derives its delay voltage from the potential difference across the two 1800 ohm resistors in the cathode circuit of the EBC 41. The detector diode, also incorporated in the EBC 41, is connected, through a similar tapping, to the last circuit. The rectified voltage across the 0.5 M Ω potentiometer is applied to the grid of the triode section of the EBC 41, through an 18,000 pF coupling capacitor.

The A.F. and output stages

The triode part of the EBC 41 enables a gain of 50, which represents so much reserve that it is possible to employ feedback up to a ratio of 3 from the output transformer, thus considerably reducing distortion in the

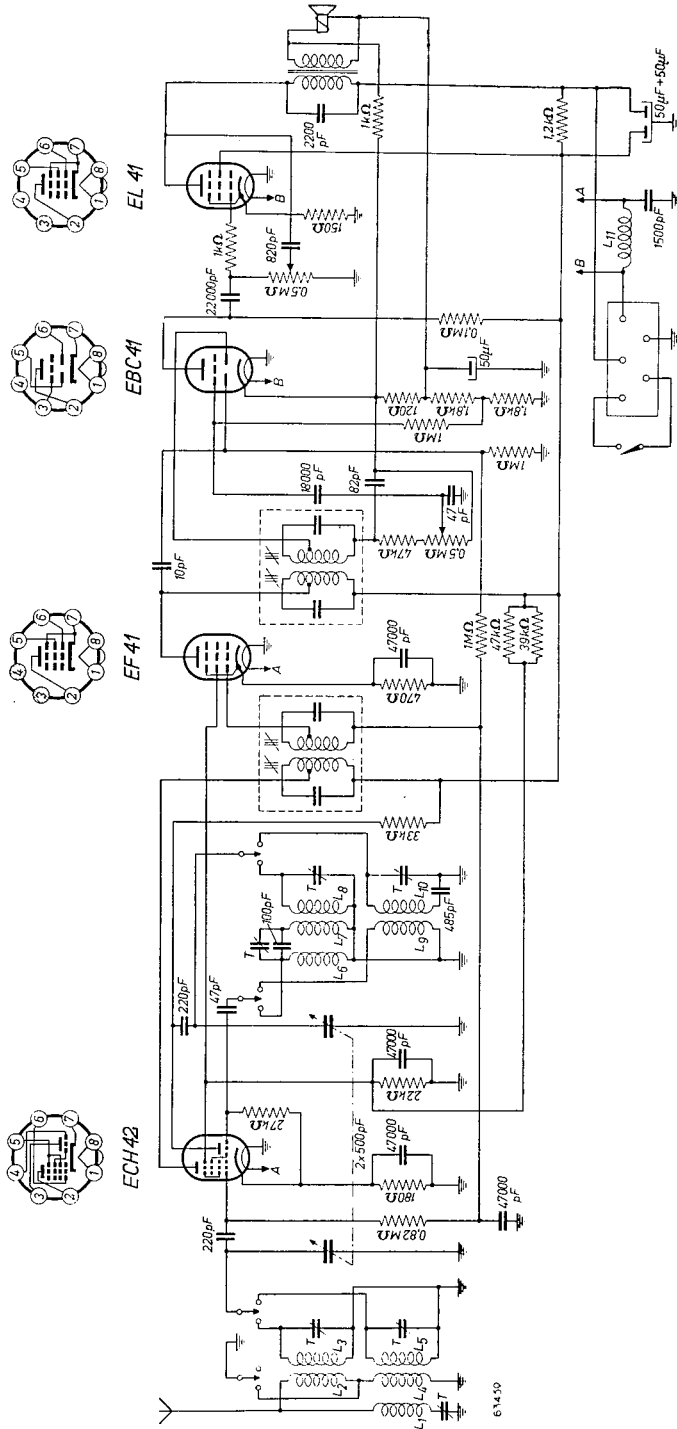

Fig. 1. Receiving circuit of a 4-valve receiver for A.C. mains and battery.

output stage. For this purpose part of the voltage on the speech coil is applied to a 120 ohm resistor in the cathode circuit of the EBC 41; the overall A.F. amplification is then about 14.

The output valve in this circuit is the EL 41, which delivers about 3 W to the loudspeaker. If low consumption is preferred to high output when battery-feed is employed, the EL 42 output valve is the obvious solution: the heater current of this valve is only 0.2 A, as compared with 0.71 A in the EL 41; the output power is only about half of that of the EL 41.

Simple but effective tone control is obtained by means of a potentiometer which also serves as grid leak for the EL 41, the variable contact being connected, via a capacitor of 820 pF, to the anode of this valve.

The power section

In view of the fact that both power units employ the same type of smoothing filter, this filter is incorporated in the receiver. The smoothing filter comprises a double electrolytic capacitor of $2 \times 50 \mu\text{F}$ and a wire-wound 1200 ohm resistor.

Power unit for A.C. mains (Fig. 4)

This unit contains a mains transformer and an AZ 41 rectifying valve. The heater voltage for the receiving valves as well as the H.T. are supplied to the receiver by means of a 5-pin tapping plate.

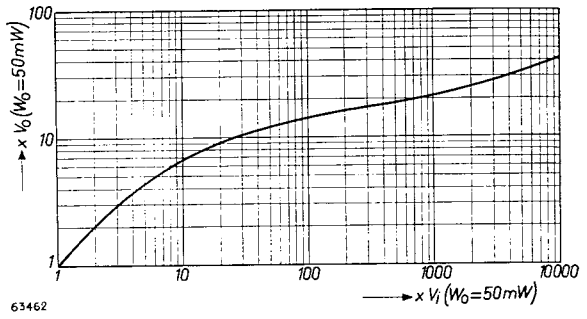

Fig. 2. A.G.C. curve of the receiver.

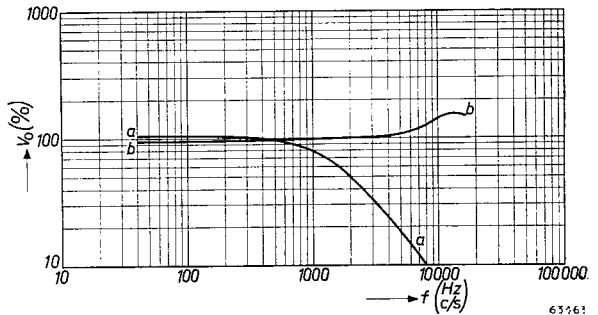

Fig. 3. Frequency-response characteristic
a) with, and b) without tone control.

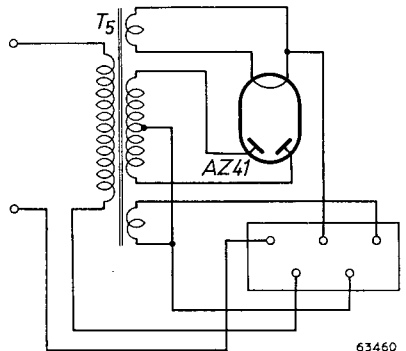

Fig. 4. Circuit of the A.C. power unit.

Power unit for battery feed (Fig. 5)

Current for this unit is supplied by a 6 V battery. The conversion of D.C. into A.C. by means of a vibrator, and the anti-interference measures involved are fully described in the chapter dealing with Circuit IV. For details of L_2 (Fig. 5) and L_{11} (Fig. 1) see Fig. 4 and 5 (page 149).

From the point of view of radiation, the filter $L_{11} + 1500 \text{ pF}$ capacitor must not be included in the vibrator section and they are, therefore, incorporated in the receiver. The A.F. ripple voltage is smoothed by a capacitor of $100 \text{ }\mu\text{F}$ and a choke (L_1) of $110 \text{ }\mu\text{H}$. Two opposed capacitors, each of $100 \text{ }\mu\text{F}$, ensure that the terminals of this power unit are independent of the polarity of the battery.

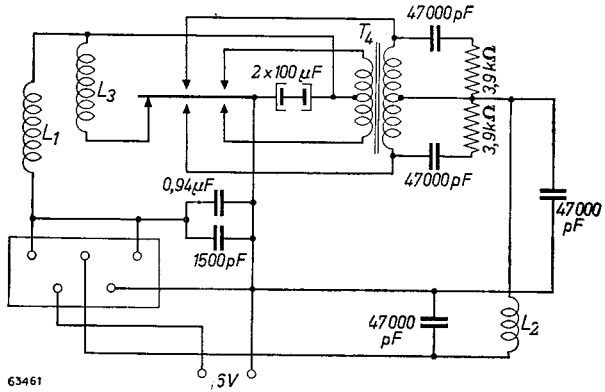

Fig. 5. Circuit of the battery power unit.

In conclusion, it should be mentioned that, whenever possible, the various circuits should be earthed at a single point. If they are earthed separately, earth currents between the different points may give rise to interference. This is particularly important in the case of the frequency changer, since the amplification is greatest beyond this valve.

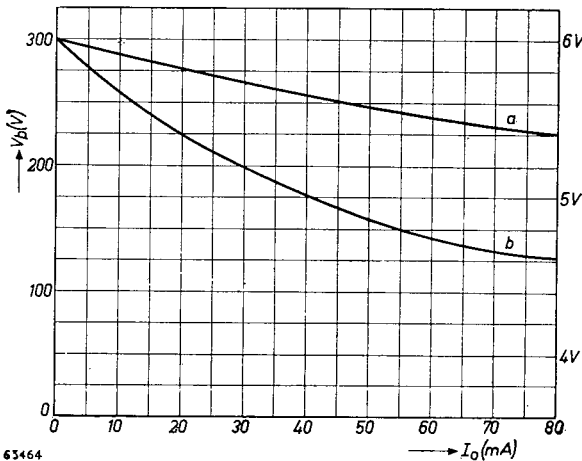

Fig. 6. Primary voltage (curve *a*) and output voltage (curve *b*) of the vibrator, as functions of the current.

MEASURED VALUES

Voltages and currents

	Mains	Battery
EL 41 - output valve		
Anode voltage	245 V	190 V
Screen grid voltage	240 V	185 V
Grid bias	-6 V	-4.4 V
Anode current	39 mA	30 mA
Screen grid current	6 mA	4.3 mA
EBC 41 - duodiode-A.F. amplifying triode		
Anode voltage	145 V	110 V
Grid bias	-1.5 V	-1.2 V
Anode current	1 mA	0.7 mA
EF 41 - I.F. amplifying pentode		
Anode voltage	240 V	185 V
Screen grid voltage	80 V	64 V
Grid bias	-2 V	-1.2 V
Anode current	3.9 mA	2.4 mA
Screen grid current	0.9 mA	0.6 mA
ECH 42 - frequency changer		
Anode voltage - hexode section	240 V	185 V
Anode voltage - triode section	130 V	90 V
Screen grid voltage	80 V	64 V
Grid bias	-1.5 V	-1.2 V
Anode current - hexode section	4 mA	2.8 mA
Screen grid current	3.5 mA	2.2 mA

Sensitivity for a standard output of 50 mW (modulation 30%)

	Mains	Battery
	approx.	approx.
At the control grid of the EL 41	1.1 V	1.15 V
„ „ „ „ „ EBC 41	78 mV	82 mV
„ „ „ „ „ EF 41	3.1 mV	3.5 mV
„ „ „ „ „ ECH 42	50 μ V	57 μ V
„ „ aerial (1000 kc/s)	14 μ V	16 μ V

Selectivity, measured at 1000 kc/s

Attenuation : 1/10	when the receiver is detuned	± 5	kc/s
1/100	„ „ „ „ „	± 8	kc/s
1/1000	„ „ „ „ „	± 12.75	kc/s

The output delivered to a 5 ohm resistor is about 3 W on mains feed, and about 2.2 W on battery feed.

III. A 4-valve A.C. superheterodyne receiver

Introduction

Four Rimlock valves are used in this receiver, viz.

ECH 41, or ECH 42 - frequency changer,

EAF 42 - detector and I.F. amplifier,

EL 41 - 9 W output pentode,

AZ 41 - full-wave rectifier.

It will be seen that only three of these valves are incorporated in the receiving section: the A.F. voltage delivered by the detector diode is supplied straight to the control grid of the EL 41 output valve. In spite of the fact that only one diode is available, delayed A.G.C. can be obtained by employing the third grid of the EAF 42 as a diode. This yields a much more satisfactory A.G.C. characteristic than a circuit in which the control is not delayed.

DESCRIPTION OF THE CIRCUIT

From the aerial to the I.F. amplifier EAF 42, the circuit is identical with that of the 5-valve superheterodyne receiver described in section I. Very briefly, the main features are as follows: an aerial coil having a high inductance is employed to secure a voltage gain of about 3.5. The frequency changer is connected in the conventional manner; the tuned oscillatory circuit is connected to the anode, which is parallel-fed through a 33,000 ohm resistor. On short waves a booster circuit is employed to ensure that sufficient oscillatory voltage will be available over the whole band, with only moderate feedback. When used in circuits having a quality factor $Q=140$, the conversion gain of the frequency changer ECH 41 is about 90, or, in the case of the ECH 42, about 125, without gain control.

Particularly in the 3-valve receiver under review, the ECH 42 gives very satisfactory results from the point of view of sensitivity.

The I.F. amplifier is the EAF 42; the one diode in the circuit is fed from a tapping on the secondary of the last I.F. transformer ($t=0.7$), to reduce damping. The overall amplification of the I.F. stage is 160 without gain control.

Detection and A.G.C.

The one diode available in this receiver is required for detection. Undelayed A.G.C. can, of course, be applied to the frequency changer and the I.F. valve. There are then two possibilities:

1. The full D.C. voltage available on the diode load can be used for A.G.C. This prevents the I.F. valve from being overloaded on strong signals, but has the disadvantage that the output valve then delivers maximum output only on strong aerial signals.
2. Only part of the control voltage across the diode load need be used for A.G.C. This ensures that the output valve will deliver maximum output

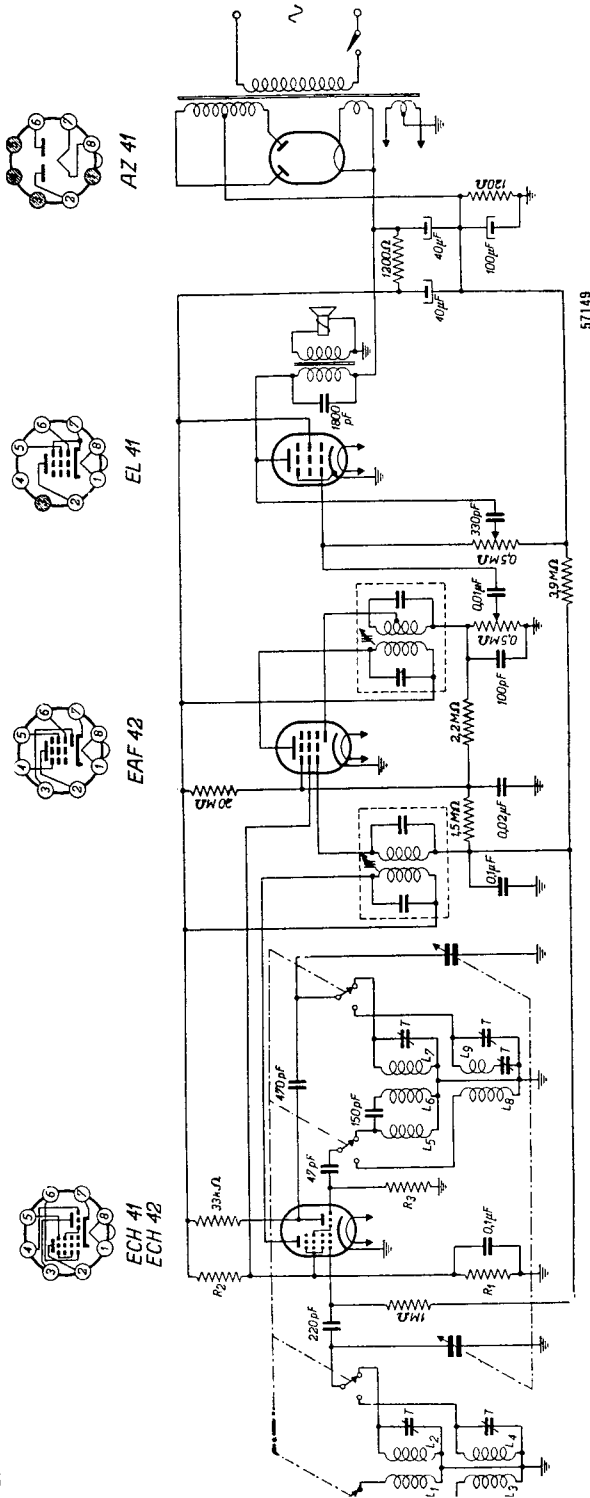

57149

Fig. 1.
A 4-valve superheterodyne A.C. receiver.
The values of the resistors to be used with the ECH 42 and ECH 41 are as follows:

ECH 42	ECH 41
$R_1 = 22 \text{ k}\Omega$	$27 \text{ k}\Omega$
$R_2 = 22 \text{ k}\Omega$	$18 \text{ k}\Omega$
$R_3 = 27 \text{ k}\Omega$	$22 \text{ k}\Omega$

power on aerial signals of moderate strength. The disadvantage here, however, is that, when strong signals are received from a local transmitter, modulation distortion and overloading of the I.F. valve are inevitable, particularly when the carrier is deeply modulated.

For these reasons the connection to the third grid of the EAF 42 has been brought out separately, so that it can be used as a delay diode as shown in Fig. 2. Here the third grid is connected to the positive line (at about 250 V) through the high-value resistor R_1 (20 M Ω in this circuit). The current I_1 (about 12.5 μ A) is then determined mainly by this resistance. Grid g_3 is further connected, through R_4 (2.2 M Ω), to the diode load and, through a potentiometer R_5 (comprising $R_2=1.5$ M Ω and $R_3=3.9$ M Ω), to the negative bias of the output valve (usually about -7 V, corresponding to the required grid bias of the EL 41).

As long as the third grid passes current, there is a small voltage between it and the cathode, which is given by

$$V_{g3} = V_{g3_0} + I_{g3} \times R_{g3},$$

where V_{g3_0} is the starting point of current to the third grid and R_{g3} is the internal resistance of the third grid with respect to the cathode. Although V_{g3_0} in particular, but also the internal resistance R_{g3} , are subject to some variation, their average values may be taken to be -0.6 V and 50 k Ω respectively.

In the absence of a signal, the third grid consumes about 10 μ A, the grid then being at roughly zero potential with respect to the cathode. The remainder of the current I_1 is divided between R_5 (I_2) and $R_4 + R_6$ (I_4). Now, as soon as an alternating voltage is applied to the detector diode, detection produces a voltage V_d across R_6 , the polarity of this voltage being such that the point B is at a negative potential with respect to earth. This in turn produces an increase in the current I_4 and, as the current I_1 is determined almost exclusively by the 20 M Ω resistor (so that it can be assumed to be constant), the current flowing to the third grid decreases.

At a certain value of V_d , the current I_{g3} drops to zero, which means that the internal resistance of grid g_3 becomes practically infinite. From this moment onwards, point A

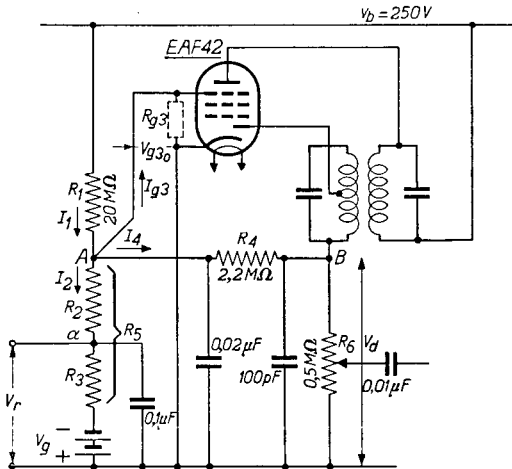

Fig. 2
The EAF 42 with third grid used as delay diode.

is at a negative potential, becoming more negative as the signal voltage across the detector diode increases. The automatic gain control then becomes effective. For preference, the A.G.C. should come into operation immediately the output valve EL 41 is fully loaded and is delivering maximum power, i.e. when the A.F. voltage on the grid of the EL 41 is 3.8 V_{RMS}, which corresponds to a direct voltage V_d of:

$$\frac{3.8 \times \sqrt{2}}{0.3} = 18 \text{ V } (m=0.3).$$

This starting point is determined by the values of the resistors R_1 , R_4 and R_5 . The tapping a on the potentiometer R_5 is so adjusted that, when weak signals are intercepted by the aerial (i.e. without control), V_r is equal to the minimum grid bias of the two valves ECH 41 or 42 and EAF 42.

In the arrangement shown in Fig. 2, the grid bias is -7 V ; hence the tapping a in this case is equal to $R_2/R_5=0.28$.

It can be shown that:

$$V_r = \frac{R_{g3} \left(\frac{V_b}{R_1} + \frac{V_g}{R_5} + \frac{V_d}{R_4} \right) + V_{g3_0}}{R_{g3} \left(\frac{1}{R_1} + \frac{1}{R_5} + \frac{1}{R_4} \right) + 1} (1-a) + a V_g.$$

Immediately the A.G.C. takes effect, $I_{g3}=0$, and R_{g3} becomes so high as to be practically infinite. The preceding formula then becomes :

$$V_r = \frac{\frac{V_b}{R_1} + \frac{V_g}{R_5} + \frac{V_d}{R_4}}{\frac{1}{R_1} + \frac{1}{R_5} + \frac{1}{R_4}} (1-a) + a V_g.$$

As previously stated, 50 kΩ and -0.6 V can be assumed to be average values for R_{g3} and V_{g3_0} . On the basis of the above formulae, the A.G.C.

characteristic can now be plotted for the circuit depicted in Fig. 2, relating to voltages and resistances of any value. The characteristic applicable to the suggested voltages and resistance values is reproduced in Fig. 3b; the curve a , representing undelayed A.G.C. employing as control voltage one-third of the voltage across the diode load, is shown for comparison.

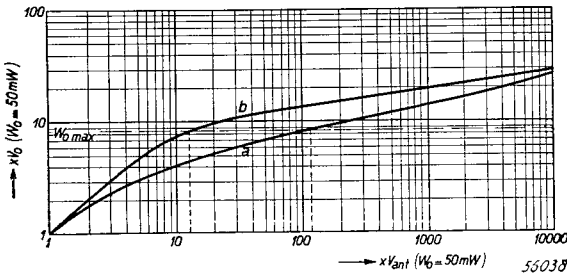

Fig. 3

- a. A.G.C. characteristic with undelayed control.
- b. A.G.C. characteristic relative to the circuit in Fig. 1.

If a low supply voltage is available in the receiver, the value of R_1 need not be so high : one might consider, for example, using the screen grid voltage of the frequency changer for this purpose. When this voltage is taken from a potentiometer, it varies only slightly with the control voltage, but, on the other hand, the A.G.C. characteristic is then not quite as flat, depending on the strength of the control applied to the valve concerned.

The output stage

The working point of the output valve is such that the anode dissipation does not reach its maximum value unless signals are received from a powerful transmitter; for details of the calculations involved see circuit description I, page 125. The grid leak of the EL 41 takes the form of a potentiometer, the sliding contact being connected through a capacitor of 330 pF to the anode, thus providing a simple, but effective, tone control.

The power section

The rectifier is the AZ 41, with a smoothing filter consisting of two electrolytic capacitors of 40 μ F in combination with a 1200 ohm resistor ; in order to avoid an excessive voltage drop across this resistor, the anode feed of the output valve EL 41 is taken from the first smoothing capacitor.

Gramophone reproduction

If the receiver is to include facilities for gramophone reproduction, the

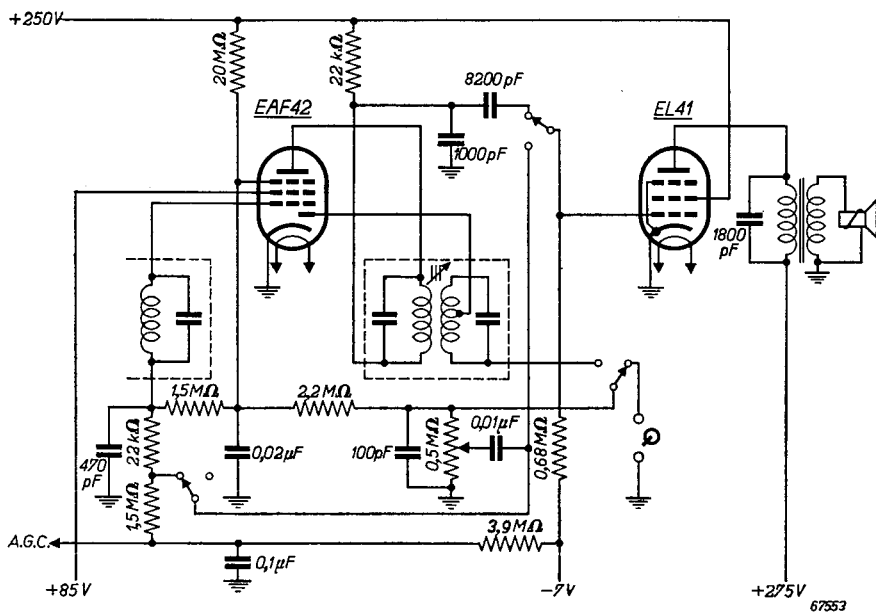

Fig. 4

Circuit diagram of the A.F. section. When a pick-up is used, the pentode section of the EAF 42 functions as an A.F. amplifier.

circuit can be changed by means of a switch, as shown in Fig. 4, so as to use the EAF 42 as an A.F. amplifier. The pick-up is connected across the volume control, from which the A.F. voltage is taken, through a coupling capacitor of $0.01 \mu\text{F}$, to the grid of the EAF 42. The amplified voltage, from a $22 \text{ k}\Omega$ resistor connected in series with the primary circuit of the last I.F. transformer, is supplied, through a capacitor of 8200 pF , to the grid of the EL 41.

When the switch is reversed, the A.F. voltage is taken, through a coupling capacitor of $0.01 \mu\text{F}$, direct to the grid of the EL 41. In this circuit the gain of the EAF 42 is 24.

MEASURED VALUES

Sensitivity (with standard output power. $W_o=50 \text{ mW}$)

At the control grid of the EL 41 0.33 V_{RMS}
 At the control grid of the EAF 42 10 mV_{RMS}
 At the grid of the ECH 41, or ECH 42

0.11 mV_{RMS} and 0.08 mV_{RMS} respectively
 approx. 30 μV_{RMS} and 23 μV_{RMS} respectively

At the aerial

When undelayed A.G.C. is employed, the control voltage being one third of the voltage across the detector load, maximum output power is obtained at an aerial signal of about 2 mV_{RMS} , but when a delay diode is used, this occurs at an aerial signal of only 0.35 mV_{RMS}

Selectivity, measured at 1000 kc/s

Attenuation : 1 : 10 when the receiver is detuned $\pm 4.25 \text{ kc/s}$
 1 : 100 when the receiver is detuned $\pm 9 \text{ kc/s}$
 1 : 1000 when the receiver is detuned $\pm 15.25 \text{ kc/s}$

Voltages and currents (without R.F. signal voltage)

Supply voltage at first smoothing capacitor 275 V
 Supply voltage at second smoothing capacitor approx. 250 V

Frequency changer	ECH 41	ECH 42
Anode current, hexode system	2.8 mA	3.0 mA
Anode current, triode system	4.1 mA	5 mA
Screen grid current	1.9 mA	3.0 mA

EAF 42, I.F. amplifier

Anode current 4.2 mA
 Screen grid current 1.3 mA

EL 41, output valve

Anode current 27 mA
 Screen grid current 4.0 mA

IV. A 5-valve receiving circuit for car radio

Introduction

The conditions to be met by a car radio differ in many respects from those imposed on domestic receivers. Many of the requirements are more stringent, with the result that considerable differences are to be found between the two types of set both in electrical design and in the general method of construction. The more important factors involved are as follows :

1. Feeding

The only voltage source available in a car is a 6 V (or 12 V) battery, which, of course, supplies D.C. The heaters can be fed direct from this source, but the high tension must be generated by some other means, such as a rotary converter or a vibrator. For some time past only vibrators have been used for this purpose, and, accordingly, the circuit here described is designed for use with a vibrator.

The vibrator converts the D.C. voltage into A.C. voltage, which is subsequently stepped up and rectified. In view of the fact that the battery must supply the power for ignition, lighting and all the other electrical equipment in the car, as well as for the heaters and anodes of the valves, low consumption is of primary importance : it is for this reason that the pentode EL 42 is used as output valve, as it consumes no more heater current than the other receiving valves, that is, 0.2 A on 6.3 V. Consequently, the total current consumption is only 4 A when the receiver is fitted with a synchronized vibrator, or 4.4 A when an EZ 41 rectifier is used.

2. Sensitivity

For obvious reasons, the height of an aerial on a car is never very great compared with that of a domestic aerial ; the average effective height of a normal, free aerial is about 1 metre, that of an aerial on a car only a few cm. Consequently, a car radio must be much more sensitive if it is to be capable of picking up the ordinary broadcast transmissions, the more so since all signals received are attenuated considerably by the screened cable connecting the aerial to the receiver. This screening is essential to ensure that the electrical equipment of the car itself will not cause interference. Where C_a is the capacitance of the aerial with respect to earth, and C_k the capacitance of the cable, the voltage at the input terminals of the

receiver is, roughly speaking, proportional to the ratio $\frac{C_a}{C_a + C_k}$. It follows,

then, that the cable capacitance should be as low and the aerial capacitance as high as possible. In fact, however, the capacitance of car aerials in general has in the progress of development gradually become lower and lower. The original car aerials were usually a strip of metallic gauze fitted between the roof of the car and the upholstery, the capacitance of such aerials being

about 150 pF, or more. With the advent of all-steel car bodies, however, this type of aerial has become impracticable and new types have been developed, including rod or wire aerials mounted under the chassis, or on the roof of the car, or the fixed or telescopic rod type attached to the wing or to the side of the body. The capacitance of these modern aerials is of the order of only 30 pF, as opposed to the 200 pF of the average domestic aerial, and the overall sensitivity of a car radio is consequently only a few microvolts, as against the 15-20 μ V usually demanded of a domestic receiver.

3. Loudspeaker output

When the vehicle is in motion, the loudspeaker of the car radio must be capable of delivering more power than that of a domestic receiver: a car in motion is fairly noisy, depending of course on the construction of the car, the speed, wind resistance, the condition of the road and so on. Moreover, a large part of the sound, particularly that in the upper register, is absorbed by the upholstery. Since the output valve, as stated in a preceding paragraph, should be dimensioned to work as economically as possible, the loudspeaker should give the highest possible output for a given amount of input power, i.e. its acoustic efficiency must be high.

4. Construction

Size is naturally an important factor for a car radio, in view of the fact that the unit is mounted behind or below the dashboard, and, moreover, should be well able to withstand jolting and vibration. In this respect Rimlock valves, which are small in size and rigidly secured in their holders, are particularly suitable for car radios. Shock-proof construction naturally means that special requirements must also be imposed on the assembly of the components, but for the sake of brevity this chapter will deal only with the electrical problems.

5. Interference

A very important difference between car radio and domestic sets is that the former is operated in the immediate vicinity of a very powerful source of interference, that is, the ignition system of the engine. Interference voltages occur not only in the H.T. and L.T. circuits of the ignition system, but also in all other circuits connected to the battery, such as the lighting circuit. Apart from the wiring, the metal chassis, too, is a source of interference voltages, as this constitutes the negative side of the electrical system of the car.

In order to avoid all these causes of interference, the receiver is so constructed that frequencies not within the broadcast range are prevented from entering the receiver; to this end the set is completely screened by a metal cabinet, and all detachable parts (e.g. parts which must be removed to gain access

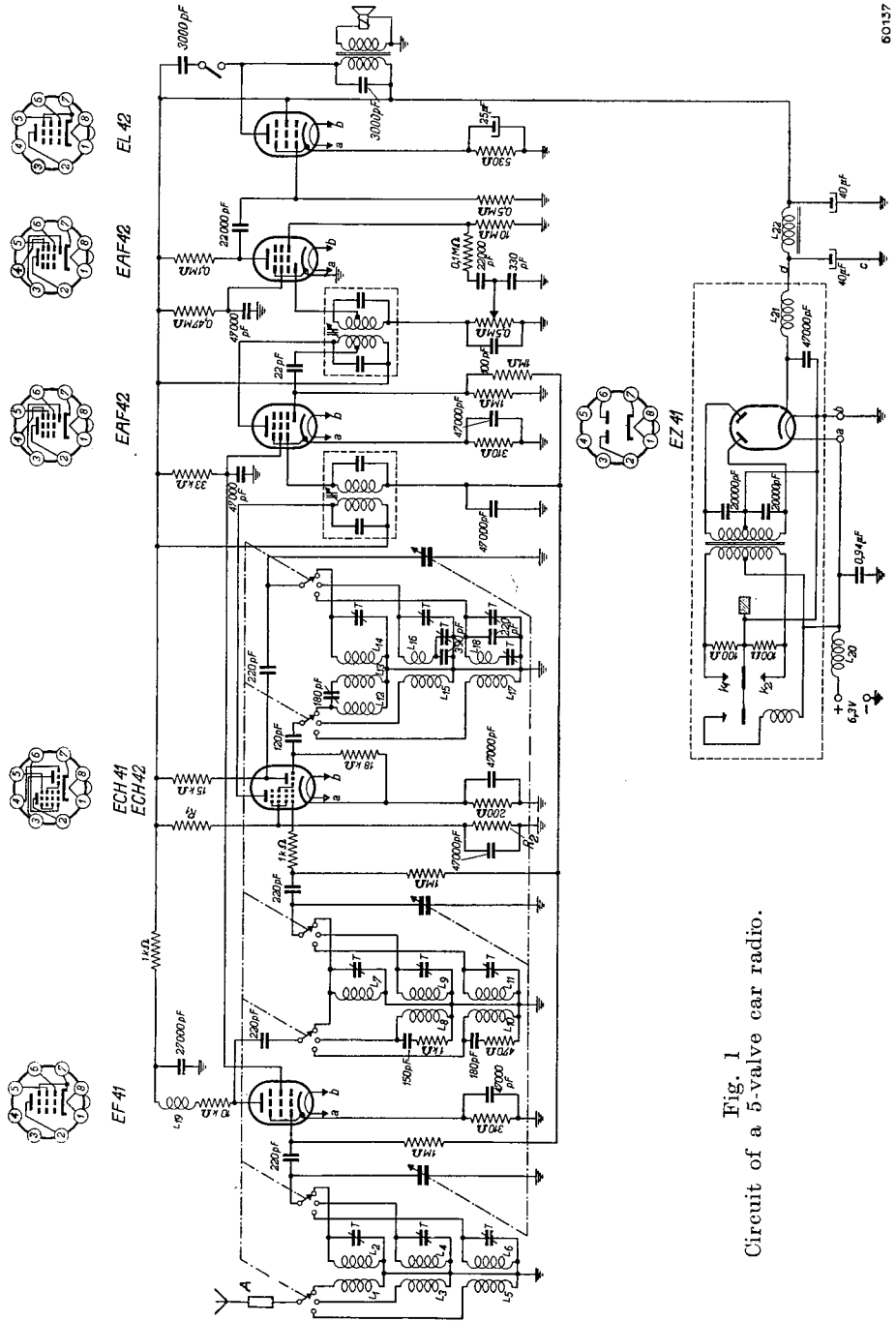

Fig. 1
Circuit of a 5-valve car radio.

to the valves) are secured by means of contact clips. Moreover, all the input leads, such as the aerial and battery leads, are fitted with special filters which reject all frequencies other than those in the broadcast range.

Description of the circuit (see Fig. 1)

The following Rimlock type valves are used in this model:

EF 41 - R.F. amplifier,

ECH 41, or 42 - triode-hexode frequency changer,

EAF 42 - A.G.C. diode and I.F. amplifier,

EAF 42 - diode-detector and A.F. amplifier,

EL 42 - 6 W output pentode,

EZ 41 - indirectly heated full-wave rectifier (unless a synchronized vibrator is used).

The receiver is designed for three wave-bands, viz :

long waves - approx. 1000 - 2000 m,

medium waves - approx. 200-600 m,

short waves - approx. 15-50 m.

The aerial and R.F. stages

As already mentioned in the introduction, the sensitivity of a car radio must be exceptionally high. This means that, especially in the short wave-band, an extra R.F. amplifying stage is necessary to keep the noise-to-signal ratio within reasonable bounds. The necessary high sensitivity could of course also be obtained by means of an extra I.F. amplifying stage, but, although this would be the simpler procedure from the point of view of the circuit, the equivalent noise resistance of the frequency changer is on the high side and this precludes any possibility of a good signal-to-noise ratio. It is with this in mind that the extra R.F. valve has been included, this being a valve with an equivalent noise resistance of approximately 6.5 k Ω , as against the 170 k Ω of the ECH 41, and 100 k Ω of the ECH 42.

The aerial may take any one of a number of forms, the most common type consisting of a rod connected to the receiver by means of a screened cable. The aerial coupling is of the high-inductance type and reduces to a minimum any effects which damping or capacitances might have on the first circuit. The average voltage gain across the aerial coupling represents a factor of 2.5.

A pentode EF 41 serves as R.F. amplifier, of which the slope in the uncontrolled condition is 2.2 mA/V. On medium and long wavelengths a tuned circuit is coupled inductively to the anode circuit, but on short wavelengths the coupling is by means of a capacitor only. To ensure uniform reception over the entire wave-band, a high-inductance coupling is employed. Further, in order that selectivity will not be too high at the ends of the medium and long wave-bands, a capacitor of 150 (or 180) pF in series with a 1 k Ω (or 470 ohm) resistor is connected in parallel with the coupling coil; the value of the capacitor is such that, with the coil, it constitutes a resonant circuit at the upper end of the wave-band. Inductive coupling is not used on short

wavelengths, as this would be too much to the detriment of the gain. The coil L_{19} is connected in series with the anode resistor, this having the effect of slightly increasing the gain at the lower end of the short-wave band. The average overall amplification of the EF 41 with this coupling is 7.

The mixing stage

The mixing stage, using the triode-hexode frequency changer ECH 41 or ECH 42, is arranged in the conventional manner. The tuned circuit of the oscillator is incorporated in the anode circuit, with the coupling coil in the grid circuit. On short wavelengths an extra coil, L_{12} , is used; the effects of this coil are described in detail on page 123. Assuming that the quality factor of the I.F. transformer circuits is $Q=140$, the conversion gain of the mixing stage is approximately 90 with the ECH 41, and about 125 in the case of the ECH 42.

The screen grids of the hexode section are fed by means of a potentiometer consisting of 33 k Ω and 47 k Ω resistors for the ECH 41, or 27 k Ω and 27 k Ω resistors for the ECH 42. In order to avoid undesirable coupling, the screen grids of the I.F. and R.F. amplifiers are fed across a separate series resistor, i.e. not by means of the same potentiometer as the frequency changer. A stopper resistor of 1 k Ω , connected direct to the control grid, serves to suppress interference.

The I.F. stage

The I.F. amplifying valve is the EAF 42 with diode to provide the delayed A.G.C., this being connected to a tapping ($t=0.7$) of the first circuit of the second I.F. transformer. The detector diode in the A.F. amplifier, also an EAF 42, is connected to the second circuit of the same transformer by means of a similar tapping: the effects of diode damping on the last I.F. transformer are thus greatly reduced. If circuits with a quality factor of 140 are used, taking into account the fact that the diodes are connected by means of tappings, an amplification of 100 may be obtained when using this I.F. amplifying valve.

Detection and A.G.C.

The diode incorporated in the I.F. amplifying valve EAF 42 is connected to a tapping on the first circuit of the second transformer in the manner described in the preceding paragraph, and supplies the delayed A.G.C. The value of the delay voltage is governed by the bias resistor of the EAF 42.

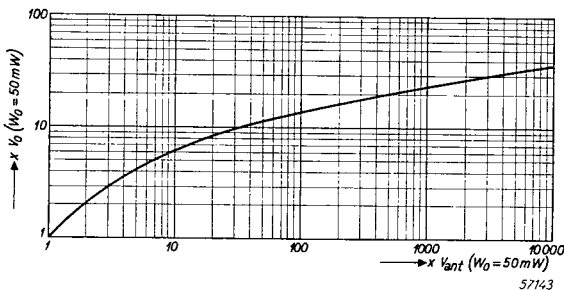

Fig. 2
A.G.C. characteristic relating to the circuit shown in Fig. 1, with an ECH 41 frequency changer.

As revealed by the A.G.C. curve in Fig. 2 (with frequency changer ECH 41), an aerial voltage of only $25 \mu\text{V}$ will produce maximum output power, but when the aerial signal increases by a factor of 10^5 , the output voltage is increased only by a factor of 10.

The A.F. and output stages

The detected signal is taken from the potentiometer in the detector circuit for applying to the grid of the second EAF 42 through a coupling capacitor. For the sake of simplicity, grid bias is provided by a grid leak of high value ($10 \text{ M}\Omega$) instead of by a separate cathode resistor. The overall gain of the A.F. stage in this circuit is about 57, with an anode load of $0.1 \text{ M}\Omega$. The absence of negative feedback in this receiver is intentional, since feedback would reduce the overall A.F. amplification.

As particularly high sensitivity is a primary feature of a car radio, the entire amplification of the EAF 42 is utilized. For this reason it may prove necessary to use an anti-microphonic holder, or to fit this valve with a damping shield.

The maximum anode dissipation of the output valve EL 42 is 6 W and, since allowances must be made for the fact that the heater voltage — i.e. the battery voltage — may reach nearly 8 V when the car is in use, the working point of the EL 42 is so adjusted that even at maximum heater voltage the anode dissipation does not exceed 6 W.

In this design model the EL 42 has an anode current of 16 mA on 6 V battery voltage, but on a battery voltage of 8 V the anode current is about 21 mA. At the same time, this increase in anode current is accompanied by a corresponding increase in anode voltage from about 200 V to roughly 290 V, which ensures that the anode dissipation does not exceed its limits even on maximum battery voltage.

The tone control with which most domestic receivers are equipped is not provided in this case. Instead, a toggle switch may be fitted to connect an extra capacitor across the primary of the output transformer: possible valve hiss can be more or less suppressed in this manner.

The power section

Power is supplied by the car battery, the D.C. voltage being converted into an A.C. voltage by a vibrator which, in principle, consists of an electromagnet which causes an armature to vibrate and alternately closes contacts k_1 and k_2 (Fig. 1). Each time one of the contacts closes, a direct current

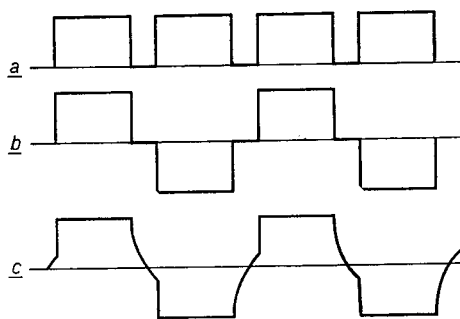

57144

Fig. 3

- a. Wave form of the D.C. fed to the primary winding of the transformer.
 b. Wave form of the voltage induced in the secondary winding by the D.C. in the primary.
 c. Wave form of the output voltage of the vibrator.

Fig. 4

Sketch of the R.F. choke included in the H.T. circuit to suppress R.F. interference.

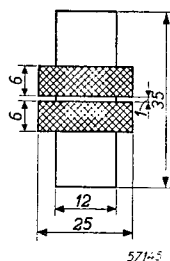

flows to the transformer, alternately through the two halves of the primary winding. This induces the necessary high tension in the secondary winding.

This high tension is subsequently rectified by the EZ 41 rectifier. To illustrate the procedure, the wave form of the D.C. fed to the primary winding of the transformer is reproduced in Fig. 3a, and that of the voltage induced in the secondary winding in Fig. 3b. In order to prevent arcing when the contacts open, two 100 ohm damping resistors are connected across the primary winding, and two 20,000 pF capacitors across the secondary. These resistors and capacitors modify the wave form of the A.C. voltage of the vibrator (see Fig. 3c). An A.C. voltage of square wave form will produce harmonics of the fundamental frequency of the vibrator, whilst arcing at the vibrator contacts produces R.F. interference voltages.

The D.C. output voltage is smoothed in the usual manner by two 40 μ F electrolytic capacitors and a 5 henry choke.

R.F. interference tends to penetrate into the receiver by three different paths :

- 1) Along the H.T. circuit. To prevent this, a smoothing filter is introduced in the form of a 47,000 pF capacitor and a R.F. choke L_{21} of approx. 3 mH (see Fig. 4). This choke is made in two sections, each containing 500 turns of 0.3 mm wire on a bobbin 12 mm in diameter.
- 2) By way of the heater leads. This circuit incorporates an R.F. smoothing filter, comprising a low-inductance capacitor of 0.94 μ F and an R.F. choke, L_{20} , of approximately 8 μ H. Since the whole of the battery current flows through this choke, its D.C. resistance must be very low, and for this reason it contains only 30 turns of 1 mm wire on a 14 mm bobbin (Fig. 5).
- 3) By radiation from those elements which tend to transfer interfering voltages to components in the receiving section. For this reason the A.F. smoothing filter must be kept away from the anti-interference unit of the vibrator, and the power transformer must be completely screened. The leads to this transformer should be kept as short as possible, to minimize any likelihood of their picking up R.F. interference.

The filters must be effectively screened and the shields must be earthed. Wherever possible, the various circuits should be earthed at a common point; if they are earthed separately, interference may result from slight potential differences and consequent eddy currents between the different points. This is particularly important in the case of both

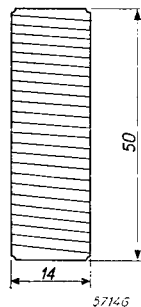

Fig. 5

Sketch of the R.F. choke included in the heater circuit to suppress R.F. interference.

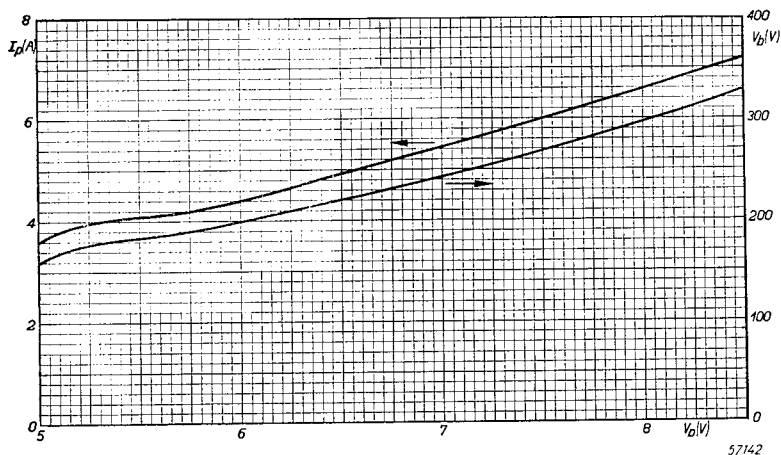

Fig. 6
Supply voltage V_b and battery current I_p as functions of the battery voltage V_p .

R.F. valve and frequency changer, since the amplification is greatest beyond these valves.

Fig. 6 shows the relation between the supply voltage of the receiver and the battery voltage; the battery current as a function of the battery voltage is also shown. It will be seen that the supply voltage is 250 V and the battery current 4.4 A on a nominal voltage of 6 V.

A synchronized vibrator, for example a Philips type 7946, can also be used for this receiver. This type of vibrator has an extra set of vibrating contacts (see Fig. 7) which do the work of a rectifying valve, and which are synchro-

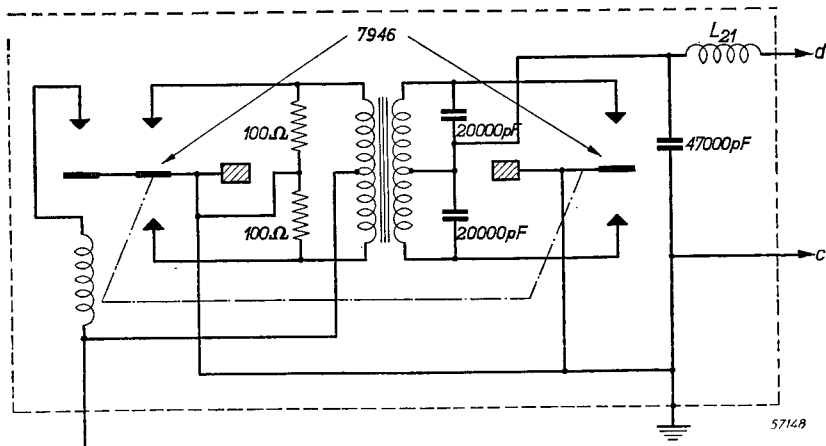

Fig. 7
Circuit of the vibrator section based on a synchronized vibrator

nized with the contacts in the primary circuit. The anode voltage is taken from the terminals *d* and *c*. This unit has two great advantages, namely higher efficiency and greater compactness; the latter feature is naturally an advantage in keeping the dimensions of the set as a whole as small as possible.

MEASURED VALUES

Sensitivity and amplification per stage (for a standard output power of 50 mW and a signal with 30% modulation)

At the grid of the EL 42 output valve	1.2 V_{RMS}
At the grid of the EAF 42 A.F. valve	21 mV_{RMS}
At the detector diode (I.F.)	300 mV_{RMS}
At the grid of the EAF 42 I.F. valve	3 mV_{RMS}
At the grid of the ECH 41, or ECH 42 frequency changer	35 μV_{RMS} , or 25 μV_{RMS}
At the grid of the EF 41 R.F. valve	5 μV_{RMS} , or 4 μV_{RMS}
At the aerial	2 μV_{RMS} , or 1.5 μV_{RMS}

Currents and voltages at nominal heater voltage of 6.3 V
(without input signal)

EF 41 - R.F. amplifier

Anode voltage	160 V
Screen grid voltage	100 V
Anode current	5 mA
Screen grid current	1.5 mA

ECH 41 or ECH 42 - frequency changer

Anode voltage, hexode section	210 V
Screen grid voltage	85 V
Anode current, hexode section	3 mA
Screen grid current	1.5 mA
Anode voltage, triode section	120 V
Anode current „ „	6 mA

EAF 42 - I.F. amplifier

Anode voltage	210 V
Screen grid voltage	100 V
Anode current	5.3 mA
Screen grid current	1.5 mA

EAF 42 - A.F. amplifier

Anode voltage	100 V
Screen grid voltage	60 V
Anode current	1.1 mA
Screen grid current	0.32 mA

EL 42 - output valve

Anode voltage	200 V
Screen grid voltage	210 V
Anode current	16 mA
Screen grid current	2.4 mA

V. A 7-valve quality A.C. mains receiver with Rimlock valves

Introduction

This design refers to a superheterodyne A.C. receiver with excellent short-wave characteristics. An extra R.F. amplifier ensures a very good signal-to-noise ratio in spite of the high sensitivity (approx. $1 \mu\text{V}$). A very straight A.G.C. characteristic is obtainable.

The A.F. pre-amplifier is an EF 40 pentode which, combined with a special tone control, ensures very high quality response.

The full complement of valves is as follows :

- EAF 42 — R.F. amplifying pentode with A.G.C. diode,
- ECH 42 — frequency changer,
- EAF 42 — I.F. amplifying pentode with detector diode,
- EF 40 — A.F. amplifying pentode,
- EL 41 — output valve,
- EM 34 — tuning indicator,
- AZ 41 — full wave rectifying valve.

This receiver is designed for three wave-bands, viz :

long waves	740—2160 m,
medium waves	165— 585 m,
short waves	14— 50 m.

It is, of course, quite a simple matter to convert the circuit to suit other wave-bands if required.

The intermediate frequency is 452 kc/s, but whether this will be suitable or not naturally depends on local circumstances.

Description of the circuit

The R.F. amplifying stage

The aerial coupling as well as the anode coupling of the EAF 42 R.F. valve is of the high-inductance type, which ensures fairly constant voltage and amplification over the entire wave-band. Since the diode of the R.F. valve is used for A.G.C., for which purpose it is connected, through a 56 pF capacitor, to the penultimate I.F. circuit, an I.F. filter is incorporated in the anode circuit of the EAF 42 in view of possible parasitic coupling. This filter comprises a coil L_8 in series with a capacitor of about 20 pF. The Q -factor of L_8 is about 127, with a self-inductance of 5 mH, and, because it is wound in four sections, very low self-capacitance (about 2 pF). An additional feature of this filter is that it greatly reduces sensitivity to I.F. voltages picked up by the aerial.

With a view to counteracting the damping effect of the 12 k Ω anode series resistor, the coil L_7 is connected in series with it; the self-inductance of this coil is about 3 mH, and it is wound in such a way as to ensure a low self-capacitance.

The mixing stage

The frequency changer is the triode-hexode ECH 42 whose screen grids are fed by means of a potentiometer comprising two resistors, one of 18 k Ω , the other of 27 k Ω . The oscillator coils should be so coupled that the grid current averages 200 μ A with a grid leak of 47 k Ω . On short-wave reception this can be obtained only by means of tight coupling, for which reason the coil L_{15} in series with a 100 pF capacitor is connected in parallel with the coupling coil L_{16} . This circuit is tuned to approximately 4.75 Mc/s, so that a fairly constant oscillator voltage with moderate feedback is obtained also on short wavelengths (further details will be found in the description of circuit I).

The I.F. amplifying stage

The frequency changer is followed by an I.F. transformer with the I.F. amplifying valve EAF 42. The I.F. transformer is the Philips type 5730, which

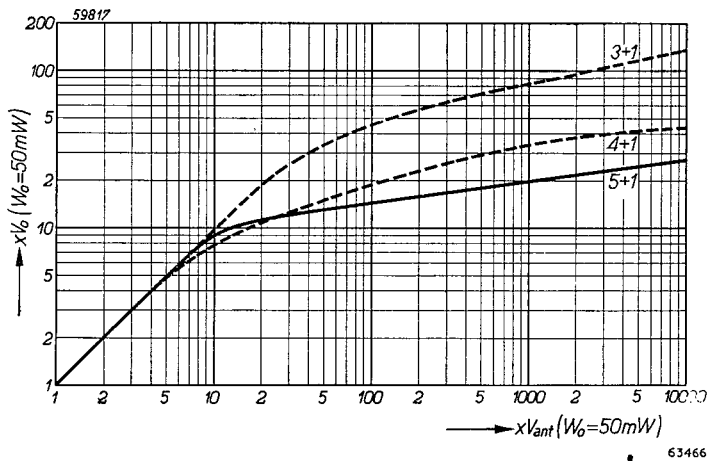

Fig. 2. A.G.C. curve (full line) of the receiver in comparison with 3- and 4-valve receivers.

has a circuit quality factor of 140 and is fitted with parallel capacitors of 115 pF.

In view of the considerable reserve of amplification in this design, the anode of the frequency changer and the control grid of the I.F. valve are connected to the transformer circuits through coil tappings of 0.7. The anode of the I.F. valve and the detector diode are connected in a similar way to the circuits of the second I.F. transformer. The advantages of this arrangement are that circuit damping is thus reduced, whilst there is then considerably less detuning when the valve capacitances are influenced by the A.G.C.

The I.F. voltage for the A.G.C. diode is taken from the penultimate I.F.

circuit and is applied through a 56 pF capacitor. The diode receives a negative voltage of about 2 V from a 33 ohm resistor in the negative line; this is the delay voltage for the A.G.C. From the A.G.C. curve in Fig. 2 (full line) it will be seen that the results are very good indeed; for comparison, the control curves of two other receivers, one with 3 valves plus rectifier, and the other a 4+1 set, are also shown in Fig. 2.

The diode of the I.F. valve EAF 42 functions as detector. A part of the rectified D.C. voltage is applied to the control grid of the EM 34 tuning indicator, which has two deflection systems ensuring accurate indications on both weak and strong signals.

The A.F. amplifying stage

The pre-amplifier valve is a straight pentode type EF 40, the tone control being connected between the volume control and the control grid of this valve. As an alternative, the tone control can be incorporated in the negative feedback circuit, but the former system is preferred for the following reasons:

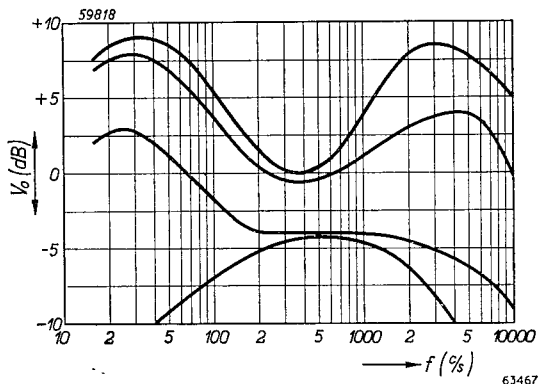

Fig. 3.

Frequency response corresponding to different settings of the tone control.

1. The internal resistance of the output stage is thus reduced on all frequencies, with corresponding improvement of the damping of loudspeaker and cabinet resonance.
2. If the tone control is incorporated in the feedback circuit, the feedback resistor in the cathode circuit of the EF 40 has to be of fairly high value, to avoid the necessity for a very large capacitance in the tone control system. A high-value resistor without decoupling in the cathode circuit might well give rise to serious hum and would also result in by no means negligible current feedback of the EF 40. In order to avoid too much reduction in sensitivity, the voltage feedback from the output transformer would then have to be reduced. In the present case the value of the feedback resistor in the cathode circuit of the EF 40 is only 12 Ω .

The action of the tone control is as follows : Imagine that the moving contacts of the 1.5 and 2.5 M Ω potentiometers are disconnected ; the value of the voltage applied to the control grid is then governed by a voltage divider comprising the RC networks 1.2 M Ω - 270 pF and 0.47 M Ω - 1000 pF. This voltage divider is practically independent of the frequency, and its component values are such that about 1/3 of the voltage on the volume control reaches the grid of the EF 40. When the moving contacts of the potentiometers are connected, however, the voltage distribution is influenced by the frequency. When, for example, the moving contact of the 2.5 M Ω potentiometer is in its lowest position, the voltage at the grid of the EF 40 at the higher frequencies is further attenuated by a second voltage divider of 0.39 M Ω - 150 pF. If the potentiometers of 2.5 M Ω and 1.5 M Ω are mounted on a common spindle, the latter potentiometer will then also be at minimum, with the result that the 1000 pF capacitor is shunted by a 1.2 M Ω resistor and the low notes are also attenuated (see bottom curve in Fig. 3).

On the other hand, when the moving contacts of the two potentiometers are at their highest positions, the low notes as well as the high are amplified with respect to the middle frequencies, since voltages of low and high frequencies from the volume control are then applied to the grid of the EF 40 almost at full strength. Fig. 3 shows the frequency response for various settings of the tone control.

The power section

The power section comprises a full-wave rectifier AZ 41 with mains transformer and smoothing filter. The latter consists of a double electrolytic capacitor of $2 \times 50 \mu\text{F}$ with a choke of approx. 5 H. In view of the fact that the anode voltage for the EL 41 output valve is taken from the first reservoir capacitor, a current of only 30 mA flows through the choke.

In order to prevent modulation hum, a capacitor of 22,000 pF is connected across one half of the H.T. winding of the mains transformer. This capacitor should be capable of withstanding a working voltage of at least 1000 V, and should be connected across that half of the H.T. winding which has the least capacitance with respect to earth.

MEASURED VALUES *)

Voltages and currents

		Without aerial signal	With signal of 0.1 V on the aerial
Voltage across the first smoothing filter		265 V	267 V
Voltage across the second smoothing filter		230 V	242 V
Voltage across the resistor in the negative line (82+33Ω)		7.7 V	7.4 V
EL 41	Anode current	27 mA	35 mA
	Screen grid current	3.6 mA	5 mA
EF 40	Anode current	0.73 mA	0.78 mA
	Screen grid current	145 μA	160 μA
EAF 42 (IF)	Anode current	5.4 mA	1.8 mA
	Screen grid current	1.45 mA	0.42 mA
ECH 42	Anode current	5.8 mA	0.65 mA
(hexode section)	Screen grid current	3.9 mA	0.63 mA
EAF 42 (RF)	Anode current	5.2 mA	1.8 mA
	Screen grid current	1.5 mA	0.42 mA
EM 34	Screen current	0.75 mA	1.2 mA

Sensitivity

The sensitivity of the various stages is measured with an output power of 50 mW as delivered by the output valve. On R.F. the measurements are carried out with a signal 30% modulated at 400 c/s.

Sensitivity

Across the volume control		35 mV _{RMS}
At the grid of the EAF 42 I.F. valve		2.45 mV _{RMS}
At the control grid of the ECH 42 frequency changer on	1570 kc/s	40 μV _{RMS}
	620 kc/s	40 μV _{RMS}
	155 kc/s	38 μV _{RMS}
	380 kc/s	40 μV _{RMS}
	6.65 Mc/s	50 μV _{RMS}
	16.45 Mc/s	55 μV _{RMS}
At the grid of the EAF 42 R.F. valve on :	1570 kc/s	4.2 μV _{RMS}
	620 kc/s	2.1 μV _{RMS}
	155 kc/s	2.1 μV _{RMS}
	380 kc/s	2.7 μV _{RMS}
	6.65 Mc/s	13 μV _{RMS}
	16.45 Mc/s	4.2 μV _{RMS}

The sensitivity at the aerial socket is computed by dividing the above values by the aerial gain. The overall sensitivity is about 1 μV.

*) Since the operating data of individual valves and components inevitably differ slightly from the published data, the measured values of voltages and currents do not always correspond to values computed on the basis of the advertised resistance values.

Second channel suppression (measured at the aerial socket)

	Image ratio
At 1000 kc/s	1 : 2300
At 300 kc/s	1 : 3250
At 10 Mc/s	1 : 21

Suppression of the I.F. signal (measured at the aerial socket)

	Suppression factor
At 1000 kc/s	1 : 33,000
At 620 kc/s	1 : 1800

Selectivity of the I.F. section

1 : 10	2×5 kc/s
1 : 100	2×8.25 kc/s
1 : 1000	2×10.75 kc/s

Selectivity of the R.F. section

At 1000 kc/s	1 : 10	2×40 kc/s
	1 : 100	2×150 kc/s
At 300 kc/s	1 : 10	2×15 kc/s
	1 : 100	2×50 kc/s
At 10 Mc/s	1 : 10	2×100 kc/s
	1 : 100	2×450 kc/s

At a frequency of 20 Mc/s and an A.G.C. voltage of -25 V, the variation in the oscillator frequency is only about 300 c/s.

Details of coils in the R.F. and oscillatory circuits

Coil	Self-inductance	Quality factor	Self-capacitance	Number of turns	Dia. of wire	Dia. of bobbin	Coupling
L_1 L_2	10 μ H 1.3 μ H		3 pF	23 $\frac{1}{4}$ 14	0.1 mm 1 mm	14 mm	$k^2=3\%$
L_3 L_4	1 mH 196.2 μ H	108	9 pF	247 159	0.1 mm 15 \times 0.05 mm	14 mm	$k^2=3.5\%$
L_5 L_6	10 mH 2.65 mH	42	10 pF	845 417	0.1 mm 0.1 mm	14 mm	$k^2=10\%$
L_9 L_{10}	1.3 μ H		3 pF	10 $\frac{1}{4}$ 14	0.1 mm 1 mm	14 mm	$k^2=10\%$
L_{11} L_{12}	19 mH 193.7 μ H	108	9 pF	1057 157	0.07 mm 15 \times 0.05 mm	14 mm	$k^2=1\%$
L_{13} L_{14}	46 mH 2.52 μ H	54	9 pF	1780 392	0.07 mm 0.1 mm	14 mm	$k^2=3\%$
L_{16} L_{17}	1.23 μ H			4 $\frac{3}{4}$ 10 $\frac{1}{4}$	0.07 mm 160 \times 0.03 mm	14 mm	$t=0.41$
L_{18} L_{19}	108.8 μ H		12 pF	24 80	0.1 mm 0.1 mm	Iron dust core	$t=0.26$
L_{20} L_{21}	612 μ H		9 pF	45 207	0.1 mm 0.1 mm	10 mm	$t=0.18$

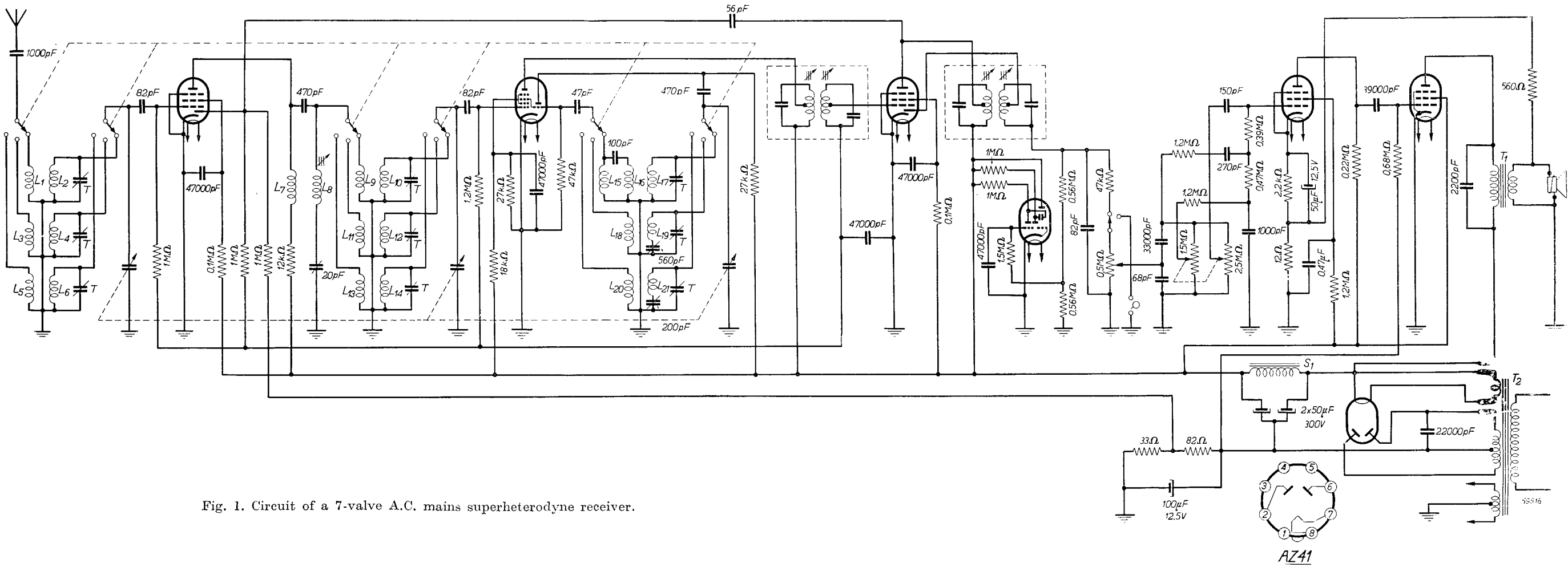
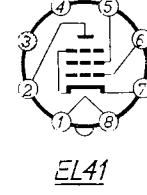
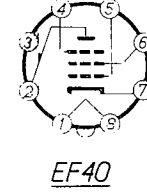
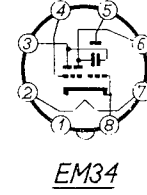
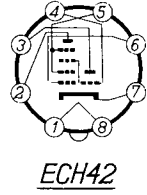
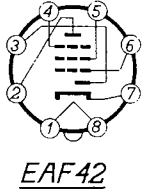

Fig. 1. Circuit of a 7-valve A.C. mains superheterodyne receiver.



VI. A 15-valve quality receiver for A.C. mains*)

Introduction

This is a suitable circuit for the more expensive types of receiver designed for quality as well as reception without interference. A laboratory model was based on the following four wave-bands :

Long wave :	710—2000 m (423.7— 150 kc/s)
Medium wave :	160— 585 m (1875—512.8 kc/s)
Short wave 1 :	46— 160 m (6.52—1.875 Mc/s)
Short wave 2 :	13.5— 46 m (22.2— 6.52 Mc/s)

It is, of course, possible to adapt the circuit for other wave-bands.

An extra R.F. pre-amplifier is provided and sensitivity is therefore exceptionally high ; second-channel suppression and noise-to-signal ratio are also excellent. Automatic selectivity control ensures that the bandwidth is narrow on weak signals and expands when the signal strength increases. This bandwidth control responds also to any strong signal which is separated from the frequency of the wanted transmitter by 9 kc/s ; hence reception is relatively free from interfering whistles. Another interesting feature is the so-called interference limiter incorporated in the detector stage, which suppresses any voltage pulses of which the strength is greater than that of a signal with 100% modulation. It almost goes without saying that a receiver of this kind is equipped with push-pull output stage and tuning indicator.

Description of the circuit

R.F. amplifying and mixing stages

The aerial signal reaches the control grid of the R.F. amplifier EF 41 through a high inductance coupling. The amplified voltage then passes through a second R.F. circuit which, in the medium and long wave-bands, is coupled inductively to the anode of the EF 41. The frequency changer, an ECH 42, is connected in the normal manner ; this arrangement is described in detail in the preceding chapters. Care should be taken that the selectivity of the R.F. section is not too high, since, otherwise, the effect of the automatic bandwidth control in the I.F. section is lost

The I.F. section

The I.F. section consists of two amplifying stages, each containing an EF 41 pentode (see also simplified circuit in Fig. 2). The other two EF 41 pentodes (B_3 and B_4) are responsible for the bandwidth control, which functions in the following manner :

*) This design was evolved on the basis of an article "Receiver with automatic selectivity control responsive to interference" by J. F. Farrington, Proc. I. R. E., April 1939.

The variable mu valves B_3 and B_4 return part of the amplified voltage to the grid side of the amplifier valves B_1 and B_2 , respectively, through the coupling coils L_{27} and L_{31} . The polarity of these coils is such that negative feedback occurs at resonant frequency. Due to phase displacement on either side of the resonant frequency, this negative feedback diminishes according as the difference between the frequency and the resonant frequency increases; moreover, the negative feedback is attenuated as a result of the selectivity of the circuits.

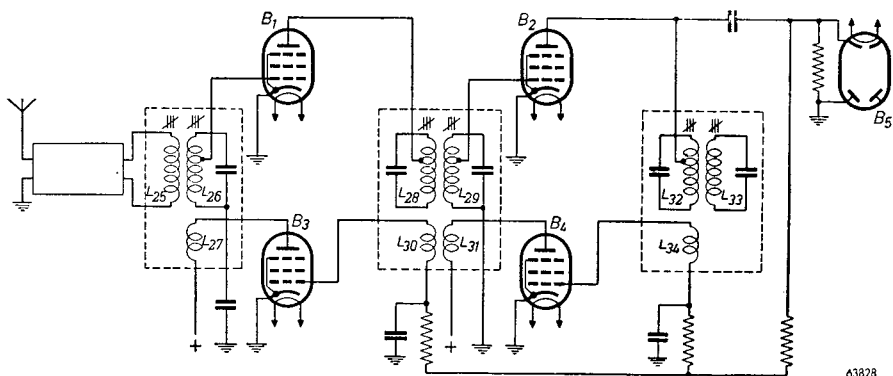

Fig. 2. Simplified circuit diagram of the I.F. section.

The bandwidth of the I.F. amplifier is increased by the negative feedback and — since the amount of feedback is proportional to the slope of the variable mu valves — the bandwidth can be varied by adjusting the slope of these valves. In the absence of a signal, or when weak signals are received, the variable mu valves are quenched by a grid bias of approximately 20 V (across resistor R_{67}), which is applied to the control grids through resistors R_{23} , R_{28} , R_{16} and R_{22} .

The necessary positive control voltage is obtained by rectifying the alternating anode voltage of B_2 on one of the diodes of the EB 91. The value of the grid bias of the variable mu valves is such that bandwidth control comes into operation at an aerial signal of approximately 20 μ V.

The screen grid voltage of these valves can be adjusted (by means of potentiometers R_{13} - R_{14} and R_{19} - R_{20}) to give approximately 150 V when the valves are quenched, and approximately 75 V when current is passing (at an aerial signal of about 100 mV). The values in the following table illustrate the effect of the bandwidth control.

With attenuation of		Bandwidth of I.F. section	
		1 : 10	1 : 100
Aerial signal	10 μ V	6.5 kc/s	12 kc/s
Aerial signal	100 μ V	10 kc/s	15 kc/s
Aerial signal	1500 μ V	17 kc/s	20 kc/s

In view of the fact that the impedance of the circuits is diminished by the negative feedback, the gain in the I.F. valves decreases. In the I.F. section the bandwidth control therefore takes the place of automatic gain control. In connection with the stability of the I.F. amplifier, it is advisable to de-couple separately the anode, screen grid and control grid feeds

Detection and A.G.C.

Detection is effected by one of the diodes of the EBC 41. The detector load consists of the series arrangement of R_{24} , R_{26} and R_{27} in parallel with the potentiometer $R_{29} - R_{30}$. The A.F. voltage is taken from this potentiometer and is supplied to the EF 40 through C_{61} and through the tone-control circuit. The voltage necessary for A.G.C. is supplied by the other diode of the EBC 41, and a delay voltage of approximately -2 V is obtained through the resistors R_{32} , R_{33} , (R_{34}), R_{71} from the potentiometer $R_{68} - R_{69} - R_{70}$. The control voltage for the R.F. amplifier and frequency changer is adjusted, by the voltage divider $R_{32} - R_{33}$, to a value such that the bandwidth control comes into operation at the appropriate signal strength.

The A.F. amplifying and output stages

A detailed description of the combined tone control is given in relation to diagram V on page 154. Fig. 3 shows a few frequency characteristics ob-

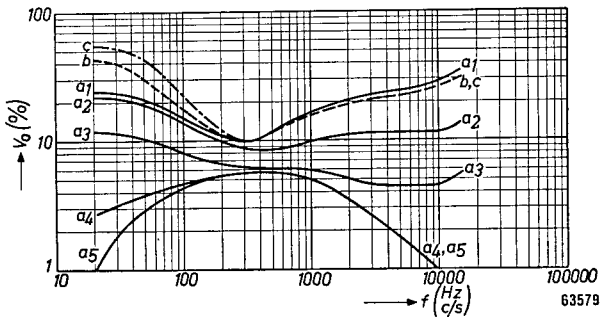

Fig. 3. Frequency characteristics (a_1 to a_5) relating to the A.F. section for various settings of the combined tone control, with volume control at maximum; input sensitivity for these curves is 62 mV_{RMS}. For curves b and c , input sensitivity is 690 mV and 10 V respectively, with tone control at the setting a_1 .

tained at different settings of the tone control. It is evident that the form of the frequency characteristic is also dependent on the setting of the volume control; this is because part of the latter is shunted by a correction network, $R_{31} - C_{62}$, resulting in so-called physiological tone control.

When the volume control is turned back, the low frequencies are amplified to a greater extent than the high frequencies. Curves a_1 to a_5 in Fig. 3 show the effect of the tone control at maximum volume. Curves b and c are obtained with input sensitivities of 690 mV and 10 V respectively, and the tone control at the setting corresponding to that for curve a_1 .

The A.F. amplifying valve is an EF 40 of which the alternating output voltage is applied, through R_{55} and C_{72} , to the control grid of the triode section of the EBC 41. Negative feedback is applied to this triode in such a way that the output signal is equal to that of the EF 40, but with 180° phase displacement.

The output stage consists of two EL 41 pentodes in a push-pull circuit which is capable of delivering 7.3 W to the speech coil, with 5% distortion.

A negative feedback voltage which is independent of the frequency is diverted from the speech coil, through R_{65} , to the cathode resistor R_{61} of the EF 40.

Automatic bandwidth compression

When a signal is received from a local transmitter the frequency of which is separated from that of the wanted transmitter by 9 kc/s, interference occurs in the form of a whistle. This signal of 9 kc/s occurs across resistors $R_{26} - R_{27}$ and reaches the grid of the EAF 42 through C_{64} ; a circuit tuned to approximately 9 kc/s, viz. $L_{35} - C_{66}$, is incorporated in the anode circuit

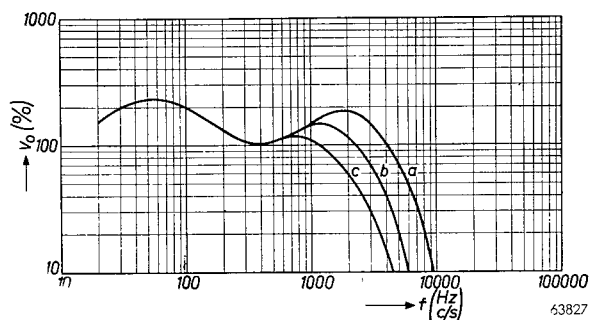

Fig. 4. Modulation characteristics of the receiver, with 30% modulation.

Curve a : for an aerial signal of approximately 2 mV.

Curve b : for an aerial signal of approximately 2 mV, accompanied by an interfering signal of equal strength, but with 9 kc/s difference in frequency.

Curve c : For a single aerial signal of approximately 6 μ V.

of this valve. The alternating anode voltage is rectified by the diode of the EAF 42, and the voltage produced across R_{41} is subsequently returned to the control grids of the two EF 41 I.F. amplifiers, as a result of which the slope of these valves is reduced, the negative feedback decreased and

the bandwidth compressed. This is illustrated in Fig. 4, where curve *a* represents the modulation characteristic obtained with an aerial signal of 2 mV. Curve *b* is the characteristic for a similar signal, accompanied by another of the same strength, but with 9 kc/s difference in frequency. It must be mentioned that, owing to the negative feedback, the amplification in the I.F. valves is practically unaffected by the slope control.

The interference limiter

The second diode of the EB 91 serves as interference limiter. All voltages of a value higher than that which corresponds to a signal with 100% modulation are suppressed. To this end, the anode of the limiter diode is connected to the capacitor C_{56} , this being charged — through R_{25} — by a voltage equal to the average voltage across $R_{26} + R_{27}$ (or across C_{52}).

The cathode of the diode is connected to the junction of R_{26} and R_{27} and is, therefore, earthed through C_{60} .

When the average voltage across C_{52} equals V_{med} , the peak voltage at 100% modulation equals $2V_{med}$, whilst the peak value of the voltage across C_{60} is one-half this amount, i.e. V_{med} ($R_{26} = R_{27}$). Immediately the modulation percentage exceeds 100%, however, for example when atmospherics occur, the peak voltage across C_{60} will predominate over the direct voltage across C_{56} and the diode of the EB 91 becomes conductive. Capacitor C_{56} is then connected directly, as it were, across R_{27} and, in view of the fact that the capacitance of C_{56} is high for music frequencies (47,000 pF), it practically forms a short circuit for these frequencies.

The tuning indicator

The D.C. voltage across resistors $R_{26} + R_{27}$ is applied to the control grid of the EM 34 tuning indicator through R_{35} . Owing to the fact that this tube contains two triode systems of unlike sensitivity, it functions excellently on both weak and strong transmitters.

The power section

Two AZ 41 rectifying valves are employed in the power section. The negative line incorporates a network of resistors and decoupling capacitors to provide the biasing voltage for the various valves.

MEASURED VALUES

Voltages and currents

		Without aerial signal	With aerial signal of 100 mV _{RMS}
Power section	Voltage across C_{76}	270 V	255 V
	Voltage across C_{77}	250 V	235 V
	Voltage across C_{81}	215 V	195 V
	Voltage across C_{73}	215 V	205 V
	Voltage across C_{78}	-19.5 V	-21 V
	Voltage across C_{79}	-7.6 V	-8.2 V
	Voltage across C_{80}	-2.2 V	-2.4 V
	Voltage across sec. winding of power transformer	2×285 V _{RMS}	—
EF 41 R.F. amplifier	Anode voltage	170 V	172 V
	Screen grid voltage	100 V	145 V
	Anode current	5.2 mA	2.4 mA
	Screen grid current	1.6 mA	0.72 mA
ECH 42 frequency changer	Anode voltage - hexode	215 V	195 V
	Screen grid voltage	74 V	86 V
	Anode current - hexode	1.4 mA	0.46 mA
	Screen grid current	2.4 mA	1.6 mA
EF 41 first I.F. amplifier	Anode voltage	215 V	195 V
	Screen grid voltage	94 V	96 V
	Anode current	5.4 mA	4.2 mA
	Screen grid current	1.5 mA	1.2 mA
EF 41 second I.F. amplifier	Anode voltage	215 V	195 V
	Screen grid voltage	92 V	92 V
	Anode current	5.0 mA	4.0 mA
	Screen grid current	1.5 mA	1.2 mA
EF 41 first control valve	Anode voltage	215 V	50 V
	Screen grid voltage	115 V	76 V
	Anode current	0.26 mA	7.0 mA
	Screen grid current	0.05 mA	2.3 mA
EF 41 second control valve	Anode voltage	215 V	46 V
	Screen grid voltage	115 V	74 V
	Anode current	0.26 mA	7.2 mA
	Screen grid current	0.08 mA	2.5 mA
EBC 41 phase inverter	Anode voltage	155 V	160 V
	Anode current	1.1 mA	1.1 mA

		Without aerial signal	With aerial signal of 100 mV _{RMS}
EAF 42 compression amplifier	Anode voltage	215 V	200 V
	Screen grid voltage	87 V	90 V
	Anode current	5.1 mA	4.8 mA
	Screen grid current	1.2 mA	1.0 mA
EF 40 A.F. amplifier	Anode voltage	180 V	175 V
	Screen grid voltage	82 V	86 V
	Anode current	0.6 mA	0.6 mA
	Screen grid current	0.12 mA	0.12 mA
2×EL 41 output valves	Anode voltage	240 V	235 V
	Anode voltage (at W_{omax})	—	225 V
	Screen grid voltage	245 V	240 V
	Screen grid voltage (at W_{omax})	—	230 V
	Anode current	2×46 mA	2×40 mA
	Anode current (at W_{omax})	—	2×50 mA
	Screen grid current	2×6.4 mA	2×5.6 mA
	Screen grid current (at W_{omax})	—	2×9.4 mA
Total current	100 mA	135 mA	

Sensitivity of the various stages, at an output power of 50 mW. The R.F. tests are carried out with a signal (400 c/s) modulated up to 30%.

At control grid of the EL 41	500 mV _{RMS}
At control grid of the EF 40	19 mV _{RMS}
At gramophone pick-up sockets	50 mV _{RMS}
At control grid of second I.F. valve EF 41 (452 kc/s)	24 mV _{RMS}
At control grid of first I.F. valve EF 41 (452 kc/s)	300 μV _{RMS}
At control grid of the ECH 42 (1570 kc/s)	24 μV _{RMS}
At control grid of the R.F. valve EF 41 (1570 kc/s)	2.2 μV _{RMS}
At aerial (1570 kc/s)	approx. 1 μV _{RMS}

Image frequency suppression (measured at aerial socket)

	Image ratio
At 1000 kc/s	1 : 2800
At 300 kc/s	1 : 50,000
At 10 Mc/s	1 : 27

Selectivity R.F. section

	Attenuation	With detuning of
At 300 kc/s	1 : 10	50 kc/s
	1 : 100	110 kc/s
At 1000 kc/s	1 : 10	90 kc/s
	1 : 100	300 kc/s
At 10 Mc/s	1 : 10	200 kc/s
	1 : 100	900 kc/s

Resistors

R_1	=	820	k Ω -0.25	W
R_2	=	100	k Ω -0.5	W
R_3	=	10	k Ω -0.5	W
R_4	=	10	k Ω -0.25	W
R_5	=	1	M Ω 0.25	W
R_6	=	27	k Ω 0.25	W
R_7	=	27	k Ω 0.5	W
R_8	=	220	Ω -0.25	W
R_9	=	220	k Ω -0.25	W
R_{10}	=	22	k Ω -0.5	W
R_{11}	=	22	k Ω -0.5	W
R_{12}	=	220	k Ω -0.25	W
R_{13}	=	33	k Ω -0.5	W
R_{14}	=	27	k Ω 0.5	W
R_{15}	=	82	k Ω -0.5	W
R_{16}	=	220	k Ω 0.25	W
R_{17}	=	22	k Ω 0.5	W
R_{18}	=	220	k Ω 0.25	W
R_{19}	=	33	k Ω 0.5	W
R_{20}	=	27	k Ω 0.5	W
R_{21}	=	82	k Ω 0.5	W
R_{22}	=	220	k Ω 0.25	W
R_{23}	=	820	k Ω 0.25	W
R_{24}	=	4700	Ω 0.25	W
R_{25}	=	1	M Ω 0.25	W
R_{26}	=	220	k Ω 0.25	W
R_{27}	=	220	k Ω 0.25	W
R_{28}	=	820	k Ω 0.25	W
R_{29}	=	650	k Ω + 200	k Ω
R_{30}	=	(log.pot.mtr.)		
R_{31}	=	33	k Ω 0.25	W
R_{32}	=	470	k Ω 0.25	W
R_{33}	=	330	k Ω -0.25	W
R_{34}	=	1	M Ω -0.25	W
R_{35}	=	1.5	M Ω 0.25	W
R_{36}	=	1	M Ω -0.5	W
R_{37}	=	1	M Ω -0.5	W
R_{38}	=	100	k Ω -0.5	W
R_{39}	=	1	M Ω -0.25	W
R_{40}	=	470	k Ω -0.5	W
R_{41}	=	3.3	M Ω -0.5	W
R_{42}	=	10	M Ω -0.5	W
R_{43}	=	47	k Ω -1	W
R_{44}	=	15	k Ω -1	W

R_{45}	=	2.5	M Ω	(log.pot.mtr.)
R_{46}	=	1	M Ω	(lin.pot.mtr.)
R_{47}	=	1.2	M Ω -0.25	W
R_{48}	=	1.2	M Ω 0.25	W
R_{49}	=	470	k Ω 0.25	W
R_{50}	=	390	k Ω 0.25	W
R_{51}	=	15	Ω 0.25	W
R_{52}	=	1.5	M Ω -0.5	W
R_{53}	=	1	M Ω -0.5	W
R_{54}	=	1	M Ω -0.5	W
R_{55}	=	1	M Ω -0.5	W
R_{56}	=	330	k Ω -0.5	W
R_{57}	=	220	k Ω 0.5	W
R_{58}	=	680	k Ω -0.25	W
R_{59}	=	680	k Ω 0.25	W
R_{60}	=	1	k Ω 0.25	W
R_{61}	=	1	k Ω 0.25	W
R_{62}	=	33	k Ω 1	W
R_{63}	=	100	k Ω 0.5	W
R_{64}	=	100	k Ω 0.5	W
R_{65}	=	560	k Ω 0.25	W
R_{66}	=	820	Ω 1	W
R_{67}	=	200	Ω 3	W
R_{68}	=	1200	Ω 0.5	W
R_{69}	=	580	Ω 0.5	W
R_{70}	=	220	Ω -0.5	W
R_{71}	=	470	k Ω -0.25	W
R_{72}	=	470	k Ω -0.25	W

Capacitors

C_1	=	1000	pF	
C_2	=	56	pF	
C_{2a}	=	56	pF	
C_3	=	30	pF	(trimmer)
C_4	=	30	pF	..
C_5	=	30	pF	..
C_6	=	30	pF	..
C_7	=	100	pF	
C_8	=	500	pF	(tuning capacitor)
C_9	=	47,000	pF	
C_{10}	=	220	pF	

C_{11}	=	10 pF
C_{12}	=	82 pF
C_{13}	=	330 pF
C_{14}	=	1.5 pF
C_{15}	=	30 pF (trimmer)
C_{16}	=	30 pF „
C_{17}	=	30 pF „
C_{18}	=	10 pF
C_{19}	=	30 pF (trimmer)
C_{20}	=	100 pF
C_{21}	=	500 pF (tuning capacitor)
C_{22}	=	47,000 pF capacitor
C_{23}	=	100 pF
C_{24}	=	56 pF
C_{25}	=	270 pF
C_{26}	=	500 pF (tuning capacitor)
C_{27}	=	6400 pF capacitor
C_{28}	=	10 pF
C_{29}	=	30 pF (trimmer)
C_{30}	=	1600 pF
C_{31}	=	30 pF (trimmer)
C_{32}	=	125 pF „
C_{33}	=	400 pF
C_{34}	=	30 pF (trimmer)
C_{35}	=	200 pF „
C_{36}	=	39 pF
C_{37}	=	30 pF (trimmer)
C_{38}	=	110 pF
C_{39}	=	110 pF
C_{40}	=	110 pF
C_{41}	=	47,000 pF
C_{42}	=	47,000 pF
C_{43}	=	47,000 pF
C_{44}	=	47,000 pF
C_{45}	=	47,000 pF
C_{46}	=	47,000 pF

C_{47}	=	47,000 pF
C_{48}	=	47,000 pF
C_{49}	=	47,000 pF
C_{50}	=	47,000 pF
C_{51}	=	47 pF
C_{52}	=	47 pF
C_{53}	=	110 pF
C_{54}	=	110 pF
C_{55}	=	47 pF
C_{56}	=	47,000 pF
C_{57}	=	10 pF
C_{58}	=	27,000 pF
C_{59}	=	47,000 pF
C_{60}	=	47 pF
C_{61}	=	39,000 pF
C_{62}	=	47,000 pF
C_{63}	=	47,000 pF
C_{64}	=	1500 pF
C_{65}	=	2700 pF
C_{66}	=	2700 pF
C_{67}	=	0.47 μ F
C_{68}	=	150 pF
C_{69}	=	270 pF
C_{70}	=	1000 pF
C_{71}	=	47,000 pF
C_{72}	=	39,000 pF
C_{73}	=	50 μ F - 400 V
C_{74}	=	33,000 pF
C_{75}	=	33,000 pF
C_{76}	=	} $2 \times 50 \mu$ F - 400 V
C_{77}	=	
C_{78}	=	100 μ F - 25 V
C_{79}	=	47,000 pF
C_{80}	=	47,000 pF
C_{81}	=	50 μ F - 400 V

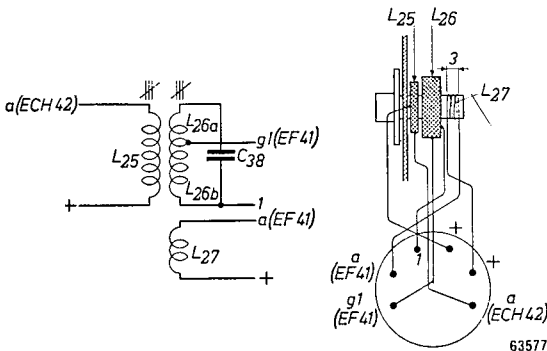

Fig. 5. Circuit and general arrangement of first I.F. transformer. L_{25} and L_{26} are standard I.F. coils for an intermediate frequency of 452 kc/s, with 0.7 tapping. L_{27} contains 27 turns of wire of 0.3 mm diameter, wound in three layers. The diameter of the can is 30 mm, the height 56 mm.

63577

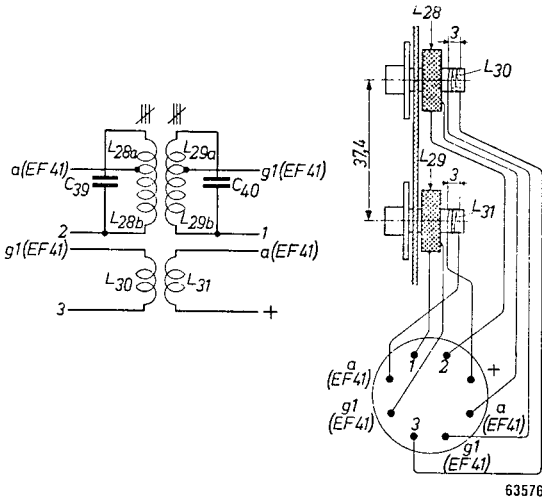

Fig. 6. Circuit and general arrangement of the second I.F. transformer. L_{28} and L_{29} are standard I.F. coils for an intermediate frequency of 452 kc/s, with 0.7 tapping. The coupling coils L_{30} and L_{31} each contain 8 turns of wire of 0.3 mm diameter, wound in a single layer. The diameter of the can is 30 mm, the height 93 mm.

63576

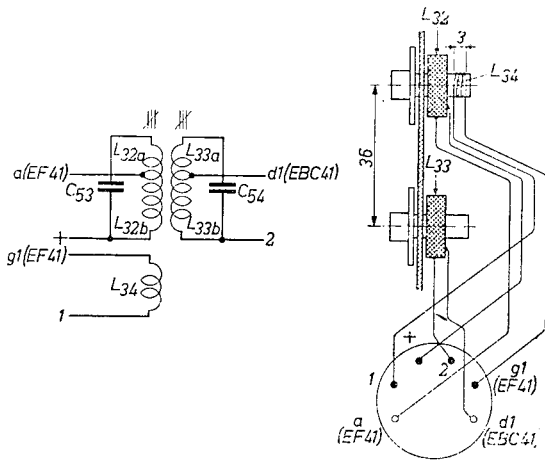

Fig. 7. Circuit and general arrangement of the third I.F. transformer. L_{32} and L_{33} are standard I.F. coils for an intermediate frequency of 452 kc/s, with 0.7 tapping. The coupling coil L_{34} contains 8 turns of wire of 0.3 mm diameter, wound in a single layer. The diameter of the can is 30 mm, the height 93 mm. The total KQ of the transformers is approximately 0.9.

63575

Coils

Since the choice of coils for the R.F. section is governed partly by the required wave-bands, particulars are given only of the coils made specially for this model.

First I.F. transformer ($L_{25} - L_{26} - L_{27}$) - see Fig. 5.

Second I.F. transformer ($L_{28} - L_{29} - L_{30} - L_{31}$) - see Fig. 6.

Third I.F. transformer ($L_{32} - L_{33} - L_{34}$) - see Fig. 7.

$L_{35} = 100$ mH

$L_{36} - L_{37}$ - output transformer, adapted to a primary impedance of 7000Ω between the two anodes.

L_{38} - choke, 8 H - 115 mA.

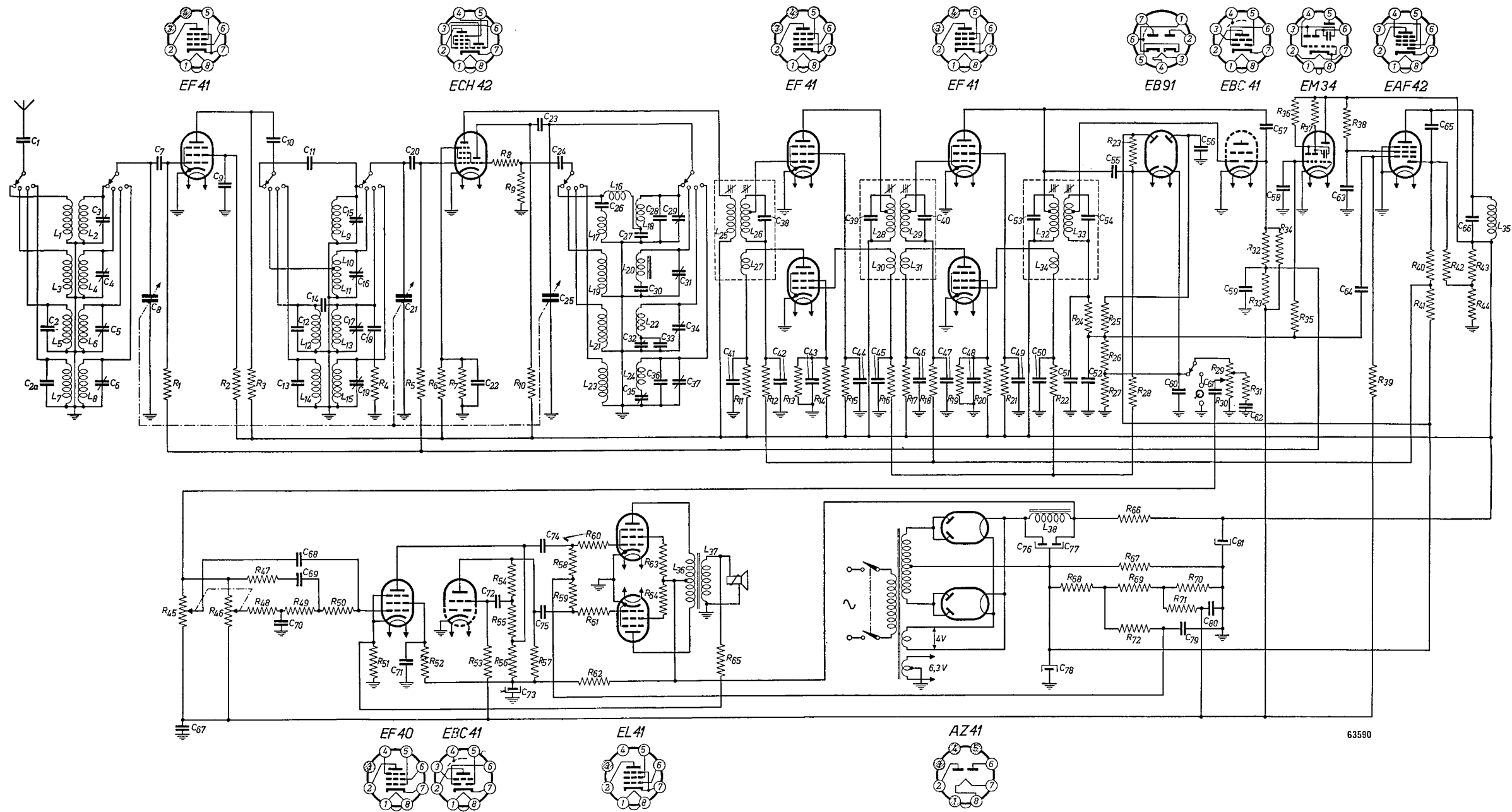

Fig. 1. Circuit of 15-valve quality receiver for A.C. mains.

The Rimlock U-series of broadcast valves

This series comprises the types UAF 42, UB 41, UBC 41, UCH 41, UCH 42, UF 41, UL 41, UY 41 and UY 42. In suitable combinations, this series forms the basis for many simple as well as high-quality A.C./D.C. receivers which, when suitably constructed, will be fully universal, i.e. suitable for operation on all A.C. and D.C. voltages between 110 and 250 V, with only slight alterations in the power section. Since all the valves in the U-series are capable of operating at any voltage within the range indicated without any modification to the main circuit, the necessary alteration in the power section is limited to the heater circuit only, thus providing a simple solution to the supply problem.

The heater current for valves in the U-series is 100 mA. By reducing to a minimum the amount of power required to heat the cathode, it has become possible to connect a complete set of five Rimlock valves, e.g. the UCH 42, 2×UAF 42, the UL 41 and the UY 41, in series with mains of from 110 to 127 V. Compared with a corresponding set of lock-in valves, for example, in which case the heaters must be connected in two parallel chains, a considerable amount of power is saved. Furthermore, a set of Rimlock valves as mentioned can be connected either to 110 V or to 127 V mains without a ballast resistor, which represents a notable saving in material, particularly as the mains tapping switch can then be of quite simple design.

Apart from their heaters, the pre-amplifying valves in the Rimlock U-series are wholly identical with corresponding E-types. Hence the most important components of the circuit in which the valves are to be used are also identical to those with E-valves. Owing to the differences in the feed, however, the output and rectifying valves of the U and E-series are of completely different design.

The output valve UL 41 is a 9 W pentode with a slope of 9.5 mA/V; it is capable of delivering an output of 4.0 W with 10% distortion at an anode voltage of 170 V, corresponding to a line voltage of 220 V, but, if greater distortion is permissible, the output can be increased to 4.7 W. For an anode voltage of 100 V, corresponding to a mains voltage of 110 V, the output is 1.25 W.

The rectifier UY 41 delivers a rectified current of 100 mA, which is more than sufficient for any set of Rimlock valves in a conventional type of receiver. Another rectifier, the UY 42, is also capable of supplying 100 mA D.C., but, whereas the UY 41 will rectify voltages up to 250 V, this valve is suitable only for voltages up to 110 V. On the other hand, the internal resistance of the UY 42 is considerably lower than that of the UY 41, admitting of a much higher power output from the output valve on low mains voltages. In addition to the valves listed under the Rimlock U-series, another valve, the UF 42, has been developed for F.M. and television reception. A description of this valve is given in the chapter "Miscellaneous amplifying valves". With regard to the range of applications of the valves in the U-series, it will suffice to refer the reader to the same subject relative to the E-series on page 22; it should be remembered, however, that the range of E-types is more comprehensive than that of the U-types.

UAF 42 (UAF 41) Variable-mu diode-pentode

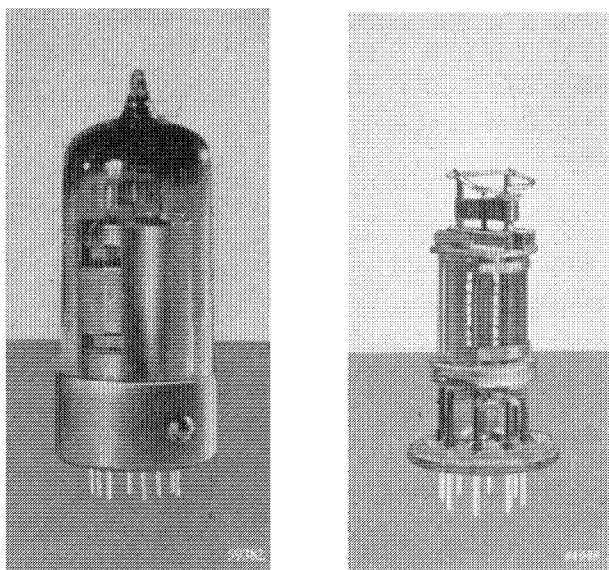

Fig. 1

The UAF 42, showing the electrode system (approximately actual size).

The UAF 42 is a variable-mu diode-pentode for A.C./D.C. receivers having a heater circuit carrying 100 mA. The pentode section is intended for use as R.F., I.F. or A.F. amplifier, the diode section being suitable for detection and A.G.C.

Since the UAF 42 — apart from the heater — is identical with the EAF 42, further particulars will be found in the description of the latter valve.

TECHNICAL DATA OF THE DIODE-PENTODE UAF 41

Heater data

Heating: A.C. or D.C., indirect, series feed

Heater current I_f = 100 mA

Heater voltage V_f = 12.6 V

Capacitances (cold valve)

Pentode section

Input capacitance C_{g1} = 4.0 pF

Output capacitance C_a = 6.5 pF

Anode - control grid C_{ag1} < 0.002 pF

Heater - control grid C_{g1f} < 0.05 pF

UAF 41

Diode section

Anode - cathode	C_{da}	=	3.8 pF
Anode - heater	C_{df}	<	0.02 pF

Between diode and pentode sections

Diode anode - pentode control grid	C_{dg1}	<	0.0015 pF
Diode anode - pentode anode	C_{da}	<	0.15 pF

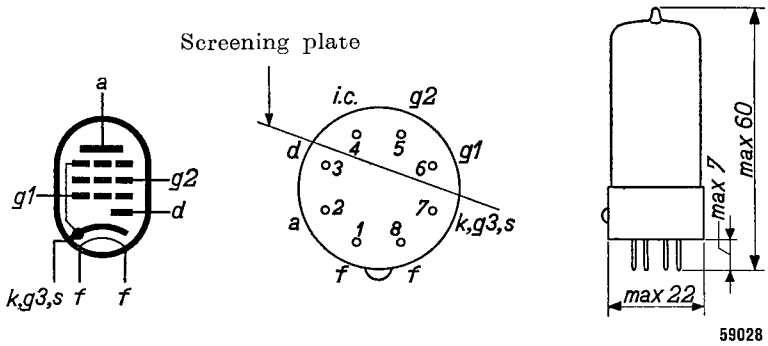

Fig. 2
Electrode arrangement, electrode connections and maximum dimensions in mm of the UAF 41.

Operating characteristics of the pentode section used as R.F. or I.F. amplifier (see Figs. 6 and 7)

Anode and supply voltage	$V_a = V_b =$	100	170	V
Screen grid resistor	$R_{g2} =$	44	44	kΩ
Bias resistor	$R_k =$	300	300	Ω
Grid bias	$V_{g1} =$	$\overline{-1.1 \quad -17}$	$\overline{-2 \quad -28}$	V
Anode current	$I_a =$	2.8 —	5 —	mA
Screen grid current	$I_{g2} =$	0.9 —	1.6 —	mA
Mutual conductance	$S =$	1650 16.5	1800 18	μA/V
Internal resistance	$R_i =$	1.0 >10	1.2 >10	MΩ
Equivalent noise resistance	$R_{eq} =$	7 —	9 —	kΩ
Amplification factor, second grid with respect to first grid	$\mu_{g2g1} =$	19 —	19 —	

Operating characteristics of the pentode section used as resistance-coupled A.F. amplifier (for circuit see Fig. 5; for microphonic properties of this circuit see description of the EAF 42)

- A. Supply voltage $V_b=170$ V Anode resistor $R_a=0.2$ M Ω
 Bias resistor $R_k=2.7$ k Ω Screen grid resistor $R_{g2}=0.73$ M Ω

Control voltage $-V_R$ (V)	Anode current I_a (mA)	Screen grid current I_{g2} (mA)	Amplification V_o/V_i	Distortion (%) at an output voltage of		
				3 V_{RMS}	5 V_{RMS}	8 V_{RMS}
0	0.58	0.18	78	0.8	1.1	1.6
5	0.46	0.13	25	1.2	2.1	4.0
10	0.36	0.08	15	2.0	3.2	4.8
15	0.26	0.05	10	2.6	3.7	5.8
20	0.18	0.03	7	3.0	4.4	7.3
25	0.12	0.01	5	5.1	8.0	13.0

- B. Supply voltage $V_b=100$ V Anode resistor $R_a=0.2$ M Ω
 Bias resistor $R_k=2.7$ k Ω Screen grid resistor $R_{g2}=0.73$ M Ω

Control voltage $-V_R$ (V)	Anode current I_a (mA)	Screen grid current I_{g2} (mA)	Amplification V_o/V_i	Distortion (%) at an output voltage of:		
				3 V_{RMS}	5 V_{RMS}	
0	0.34	0.10	73	0.8	1.0	
2.5	0.26	0.07	27	3.0	4.0	
5.0	0.20	0.05	15	3.5	5.0	
7.5	0.16	0.04	10	3.8	5.7	
10.0	0.12	0.02	7	4.4	7.5	
12.5	0.08	0.01	5.5	5.7	9.0	

Operating characteristics of the pentode section used as resistance-coupled A.F. triode (screen grid connected to anode)

- A. Supply voltage $V_b=170$ V Anode resistor $R_a=0.1$ M Ω
 Bias resistor $R_k=1.2$ k Ω

Control voltage $-V_R$ (V)	Anode current I_a (mA)	Amplification V_o/V_i	Distortion (%) at an output voltage of		
			3 V_{RMS}	5 V_{RMS}	8 V_{RMS}
0	1.3	15	1.2	1.8	3.4
5	0.9	7.3	1.5	2.4	3.8
10	0.6	5.0	1.3	2.1	3.0
15	0.4	3.7	1.9	3.7	6.0
20	0.2	2.6	4.0	6.8	9.5

UAF 41

B. Supply voltage $V_b=100$ V Anode resistor $R_a=0.1$ M Ω
 Bias resistor $R_k=2.3$ k Ω

Control voltage — V_R (V)	Anode current I_a (mA)	Amplification V_o/V_i	Distortion (%) at an output voltage of		
			3 V_{RMS}	5 V_{RMS}	
0	0.55	12	1.9	2.8	
2.5	0.45	7.2	2.6	5.6	
5.0	0.30	4.9	2.3	4.9	
7.5	0.20	3.8	3.0	6.0	
10	0.15	2.8	6.0	10.0	

Limiting values of the pentode section

Anode voltage, valve biased to cut-off	V_{a_0}	= max.	550 V
Anode voltage	V_a	= max.	250 V
Anode dissipation	W_a	= max.	2 W
Screen grid voltage, valve biased to cut-off	V_{g2_0}	= max.	550 V
Screen grid voltage, valve controlled	$V_{g2}(I_a < 3 \text{ mA})$	= max.	250 V
Screen grid voltage, valve not controlled	$V_{g2}(I_a = 6 \text{ mA})$	= max.	150 V
Screen grid dissipation	W_{g2}	= max.	0.3 W
Cathode current	I_k	= max.	10 mA
Grid current starting point	$V_{g1}(I_{g1} = +0.3 \mu\text{A})$	= max.	-1.3 V
External resistance between first grid and cathode	R_{g1}	= max.	3 M Ω
External resistance between heater and cathode	R_{fk}	= max.	20 k Ω
Voltage between heater and cathode	V_{fk}	= max.	150 V

Limiting values of the diode section

Peak anode inverse voltage	$V_{d \text{ inv } p}$	= max.	350 V
Diode current	I_d	= max.	0.8 mA
Peak diode current	I_{dp}	= max.	5 mA
Diode current starting point	$V_d(I_d = +0.3 \mu\text{A})$	= max.	-1.3 V
External resistance between heater and cathode	R_{fk}	= max.	20 k Ω
Voltage between heater and cathode	V_{fk}	= max.	150 V

TECHNICAL DATA OF THE DIODE-PENTODE UAF 42

Heater data

Heating: indirect, A.C. or D.C., series feed

Heater current	I_f	=	100 mA
Heater voltage	V_f	=	12.6 V

Capacitances (cold valve)

Pentode section

Input capacitance	C_{g1}	=	4.1 pF
Output capacitance	C_a	=	5.2 pF
Anode - control grid	C_{ag1}	<	0.002 pF
Heater - control grid	C_{gf}	<	0.05 pF

Diode section

Anode - cathode	C_a	=	3.3 pF
Anode - heater	C_{af}	<	0.02 pF

Between diode and pentode sections

Diode anode - pentode control grid	C_{ag1}	<	0.0015 pF
Diode anode - pentode anode	C_{aa}	<	0.15 pF

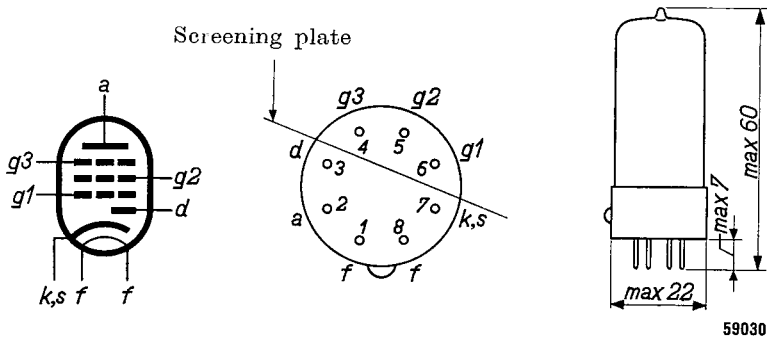

Fig. 3

Electrode arrangement, electrode connections and maximum dimensions in mm of the UAF 42.

UAF 42

Operating characteristics of the pentode section used as R.F. or I.F. amplifier (see Figs. 8 to 11 incl.)

Anode and supply voltage	$V_a = V_b =$	100	170	V
Voltage on third grid	$V_{g3} =$	0	0	V
Screen grid resistor	$R_{g2} =$	56	56	k Ω
Bias resistor	$R_k =$	310	310	Ω
Grid bias	$R_{g1} =$	$\overline{-1.2 \quad -16}$	$\overline{-2 \quad -28}$	V
Screen grid voltage	$V_{g2} =$	50	85	V
Anode current	$I_a =$	2.8	5	mA
Screen grid current	$I_{g2} =$	0.9	1.5	mA
Mutual conductance	$S =$	1700	2000	20 $\mu\text{A/V}$
Internal resistance	$R_i =$	0.85 >10	0.9 >10	M Ω
Equivalent noise resistance	$R_{eq} =$	5.8	7.5	k Ω
Amplification factor, second grid with respect to first grid	$\mu_{g2g1} =$	16	16	—

Anode and supply voltage	$V_a = V_b =$		200	V
Voltage on third grid	$V_{g3} =$		0	V
Screen grid resistor	$R_{g2} =$		76	k Ω
Bias resistor	$R_k =$		310	Ω
Grid bias	$V_{g1} =$		$\overline{-2 \quad -34}$	V
Screen grid voltage	$V_{g2} =$		85	V
Anode current	$I_a =$		5	mA
Screen grid current	$I_{g2} =$		1.5	mA
Mutual conductance	$S =$		2000	20 $\mu\text{A/V}$
Internal resistance	$R_i =$		1.0 >10	M Ω
Equivalent noise resistance	$R_{eq} =$		7.5	k Ω
Amplification factor, second grid with respect to first grid	$\mu_{g2g1} =$		16	—

Operating characteristics of the pentode section used as R.F. or I.F. amplifier (Screen grid voltage obtained by means of the same potentiometer as that of the UCH 41, for circuit diagram see Fig. 4 ; see also Figs. 15, 16 and 17)

Anode and supply voltage	$V_a = V_b =$	100	170	V
Voltage on third grid	$V_{g3} =$	0	0	V
Resistor between supply voltage and screen grids	$R_1 =$	12	12	k Ω
Resistor between screen grids and chassis	$R_2 =$	27	27	k Ω
Bias resistor	$R_k =$	250	250	Ω
Grid bias	$V_{g1} =$	$\overline{-1.0 \quad -10.5}$	$\overline{-1.8 \quad -18}$	V
Screen grid voltage	$V_{g2} =$	53	87	117 V
Anode current	$I_a =$	3.0	5.5	mA
Screen grid current	$I_{g2} =$	1.0	1.7	mA
Mutual conductance	$S =$	1850	2100	21 $\mu\text{A/V}$
Internal resistance	$R_i =$	0.75 >10	0.8 >10	M Ω
Equivalent noise resistance	$R_{eq} =$	6	8	k Ω
Amplification factor, second grid with respect to first grid	$\mu_{g2g1} =$	16	16	—

Operating characteristics of the pentode section used as R.F. or I.F. amplifier; screen grid voltages of UAF 42 and UCH 42 obtained by means of a common potentiometer (see Figs. 18, 19 and 20)

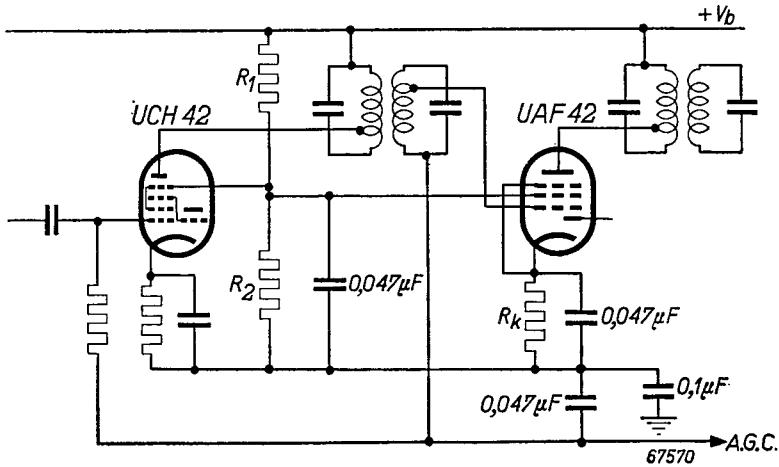
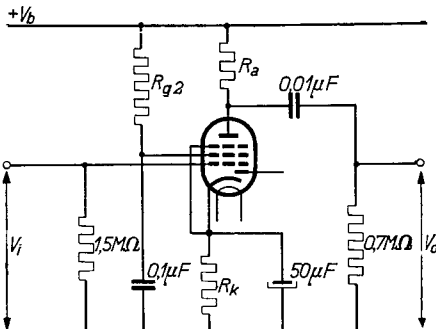

Fig. 4

Anode and supply voltage	$V_a = V_b =$	100	170	V
Voltage on third grid	$V_{g3} =$	0	0	V
Resistor between supply voltage and screen grids	$R_1 =$	15	15	kΩ
Resistor between screen grids and chassis	$R_2 =$	22	22	kΩ
Bias resistor	$R_k =$	330	330	Ω
Grid bias	V_{g1}	= -1.0 — -9.5		-1.8 — -15.5 V
Screen grid voltage	V_{g2}	= 43	58	70 99 V
Anode current	I_a	= 2.3	—	4.0 — mA
Screen grid current	I_{g2}	= 0.65	—	1.1 — mA
Mutual conductance	S	= 1500	15	1750 17.5 μA/V
Internal resistance	R_i	= 0.95	>10	0.95 >10 MΩ
Equivalent noise resistance	R_{eq}	= 6.1	—	7.8 — kΩ
Amplification factor, second grid with respect to first grid	μ_{g2g1}	= 16	—	16 —



Operating characteristics of the pentode section used as resistance-coupled A.F. amplifier (for particulars concerning microphony, see description of the EAF 42)

UAF 42

A. Supply voltage $V_b=170$ V Anode resistor $R_a=0.22$ M Ω
 Bias resistor $R_k=2.7$ k Ω Screen grid resistor $R_{g2}=0.82$ M Ω

Control voltage $-V_R$ (V)	Anode current I_a (mA)	Screen grid current I_{g2} (mA)	Amplification V_o/V_i	Distortion (%) at an output voltage of		
				3V _{RMS}	5V _{RMS}	8V _{RMS}
0	0.50	0.17	80	0.8	1.0	1.2
5	0.38	0.12	23	1.5	2.5	4.0
10	0.28	0.09	14	1.9	3.2	5.0
15	0.20	0.06	9	2.6	4.2	6.5
20	0.14	0.04	6	3.6	6.0	9.0

B. Supply voltage $V_b=170$ V Anode resistor $R_a=0.1$ M Ω
 Bias resistor $R_k=1.5$ k Ω Screen grid resistor $R_{g2}=0.33$ M Ω

Control voltage $-V_R$ (V)	Anode current I_a (mA)	Screen grid current I_{g2} (mA)	Amplification V_o/V_i	Distortion (%) at an output voltage of		
				3 V _{RMS}	5 V _{RMS}	8 V _{RMS}
0	1.05	0.37	68	0.75	0.8	1.1
5	0.71	0.25	20	2.2	3.2	5.0
10	0.48	0.17	10	2.4	3.7	5.5
15	0.30	0.11	6	3.0	4.5	7.0
20	0.16	0.07	3.5	5.2	8.0	12

C. Supply voltage $V_b=100$ V Anode resistor $R_a=0.22$ M Ω
 Bias resistor $R_k=2.7$ k Ω Screen grid resistor $R_{g2}=0.82$ M Ω

Control voltage $-V_R$ (V)	Anode current I_a (mA)	Screen grid current I_{g2} (mA)	Amplification V_o/V_i	Distortion (%) at an output voltage of	
				3 V _{RMS}	5 V _{RMS}
0	0.29	0.09	75	0.9	1.1
2.5	0.22	0.07	27	2.6	4.4
5.0	0.17	0.05	15	3.2	5.0
7.5	0.13	0.04	10	4.0	6.5
10	0.10	0.03	7	5.2	8.0

D. Supply voltage $V_b=100$ V Anode resistor $R_a=0.1$ M Ω
 Bias resistor $R_k=1.5$ k Ω Screen grid resistor $R_{g2}=0.33$ M Ω

Control voltage $-V_R$ (V)	Anode current I_a (mA)	Screen grid current I_{g2} (mA)	Amplification V_o/V_i	Distortion (%) at an output voltage of	
				3 V _{RMS}	5 V _{RMS}
0	0.58	0.21	60	0.9	1.0
2.5	0.43	0.14	25	2.3	4.5
5.0	0.31	0.10	12	3.5	6.0
7.5	0.21	0.07	7.5	4.7	8.0
10	0.14	0.05	5	7.0	11

Operating characteristics of the pentode section used as resistance-coupled A.F. triode (screen grid connected to anode)

A. Supply voltage $V_b=170$ V Anode resistor $R_a=0.1$ M Ω
 Bias resistor $R_k=1.8$ k Ω

Control voltage $-V_R$ (V)	Anode current I_a (mA)	Amplification V_o/V_i	Distortion (%) at an output voltage of		
			3 V _{RMS}	5 V _{RMS}	8 V _{RMS}
0	1.20	12	1.4	2.2	3.2
5	0.84	6.5	1.4	2.2	3.7
10	0.58	5.0	1.4	2.3	3.8
15	0.37	3.5	1.7	2.7	4.6
20	0.22	2.5	3.2	5.0	8.0

B. Supply voltage $V_b=170$ V Anode resistor $R_a=0.05$ M Ω
 Bias resistor $R_k=1.2$ k Ω

Control voltage $-V_R$ (V)	Anode current I_a (mA)	Amplification V_o/V_i	Distortion (%) at an output voltage of		
			3 V _{RMS}	5 V _{RMS}	8 V _{RMS}
0	2.05	12	1.3	2.0	2.9
5	1.37	6.5	1.6	2.8	4.6
10	0.92	4.5	1.7	2.9	4.8
15	0.60	3.5	2.6	4.0	6.6
20	0.32	2.2	4.5	7.5	11

C. Supply voltage $V_b=100$ V Anode resistor $R_a=0.1$ M Ω
 Bias resistor $R_k=1.8$ k Ω

Control voltage $-V_R$ (V)	Anode current I_a (mA)	Amplification V_o/V_i	Distortion (%) at an output voltage of	
			3 V _{RMS}	5 V _{RMS}
0	0.70	12	2.0	2.2
2.5	0.50	7	2.4	4.5
5.0	0.36	5	2.4	4.5
7.5	0.25	4	2.7	4.7
10	0.17	3	4.2	6.6

UAF 42

D. Supply voltage $V_b=100$ V Anode resistor $R_a=0.05$ M Ω
 Bias resistor $R_k=1.2$ k Ω

Control voltage $-V_R$ (V)	Anode current I_a (mA)	Amplification V_o/V_i	Distortion (%) at an output voltage of	
			3 V_{RMS}	5 V_{RMS}
0	1.18	12	1.7	2.6
2.5	0.80	7	3.0	5.1
5.0	0.56	5	3.6	5.7
7.5	0.38	3.5	4.2	6.8
10	0.24	2.5	6.5	10

Limiting values of the pentode section

Anode voltage, cut-off condition	V_{a_o}	= max.	550 V
Anode voltage	V_a	= max.	250 V
Anode dissipation	W_a	= max.	2 W
Screen grid voltage, cut-off condition	V_{g2_o}	= max.	550 V
Screen grid voltage, valve controlled	$V_{g2}(I_a < 2.5 \text{ mA})$	= max.	250 V
Screen grid voltage uncontrolled valve	$V_{g2}(I_a = 5 \text{ mA})$	= max.	125 V
Screen grid dissipation	W_{g2}	= max.	0.3 W
Cathode current	I_k	= max.	10 mA
Grid current starting point	$V_{g1}(I_{g1} = +0.3 \mu\text{A})$	= max.	-1.3 V
External resistance between grid 1 and cathode	R_{g1}	= max.	3 M Ω
External resistance between grid 3 and cathode	R_{g3}	= max.	3 M Ω
External resistance between heater and cathode	R_{fk}	= max.	20 k Ω
Voltage between heater and cathode	V_{fk}	= max.	150 V

Limiting values of the diode section

Peak anode inverse voltage	$V_{d \text{ inv } p}$	= max.	350 V
Diode current	I_d	= max.	0.8 mA
Peak diode current	I_{dp}	= max.	5 mA

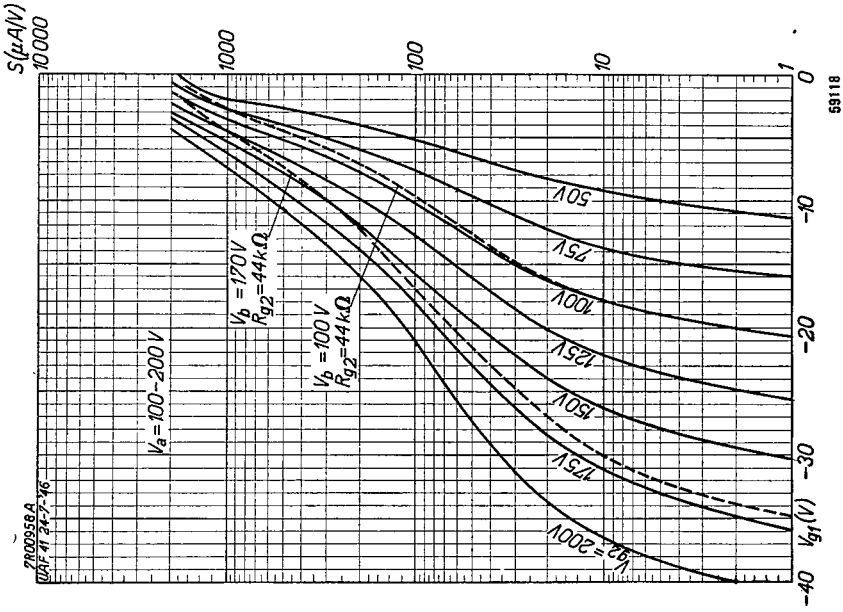

Fig. 7

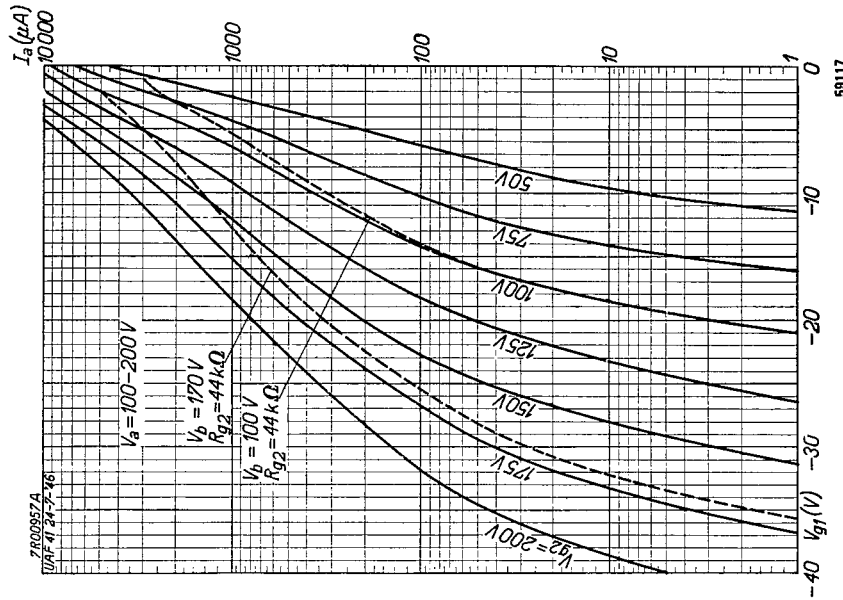

Fig. 6

Anode current (I_a , Fig. 6) and mutual conductance (S , Fig. 7) of the UAF 41 as functions of the grid bias V_{g1} for different values of the screen grid voltage (V_{g2}). The dotted lines indicate the variations in anode current and mutual conductance when a series resistor R_{g2} of 44 kΩ is included in the screen grid circuit.

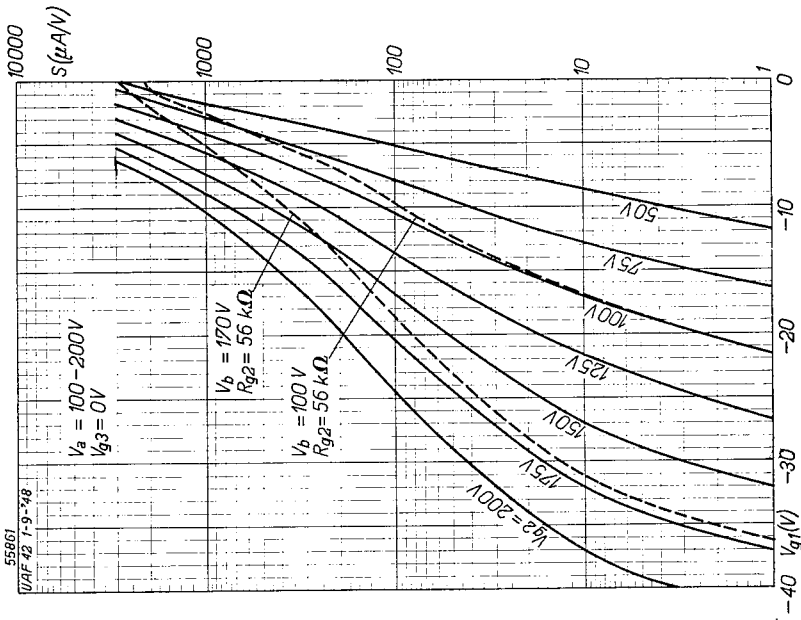

Fig. 9

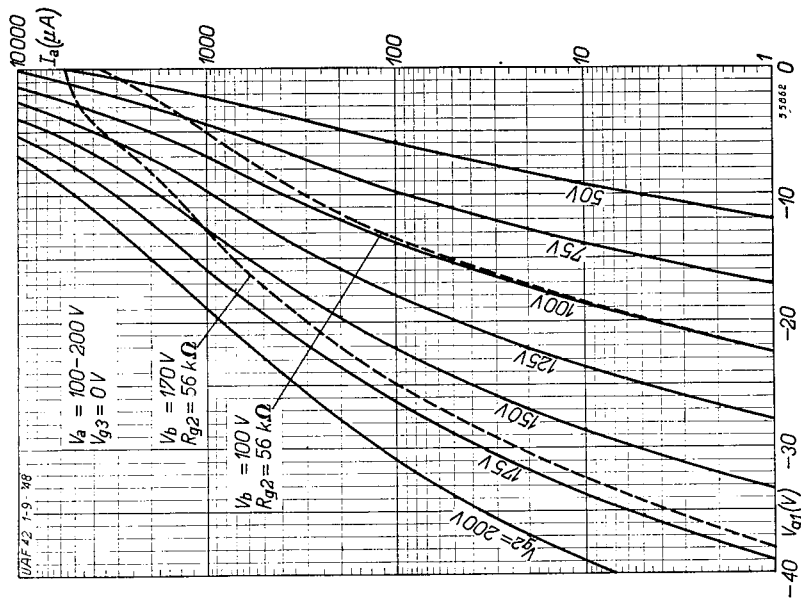

Fig. 8

Anode current (I_a , Fig. 8) and mutual conductance (S , Fig. 9) of the UAF 42 as functions of the grid bias (V_{g1}) for various values of the screen grid voltage (V_{g2}). The dotted lines indicate the variations in anode current and mutual conductance when a series resistor of 56 kΩ is included in the screen grid circuit.

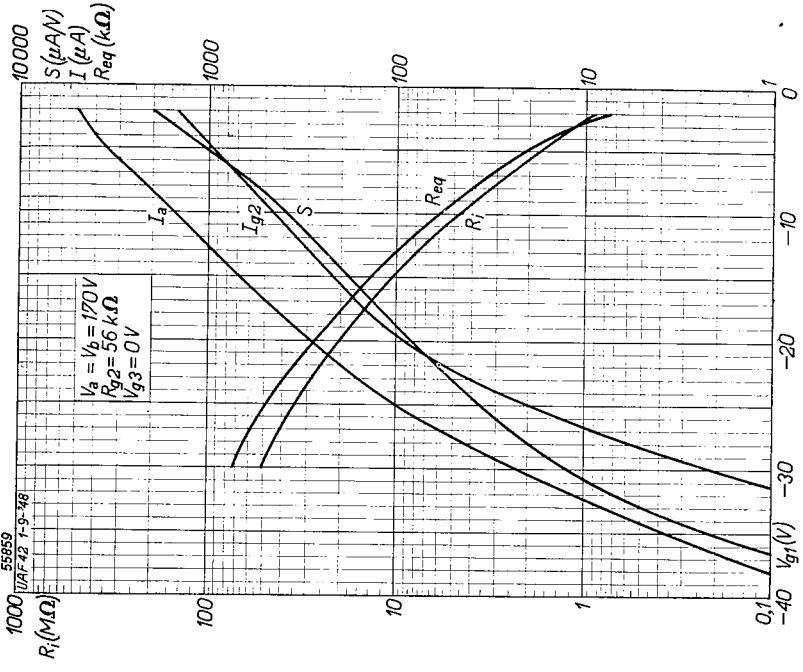

Fig. 11

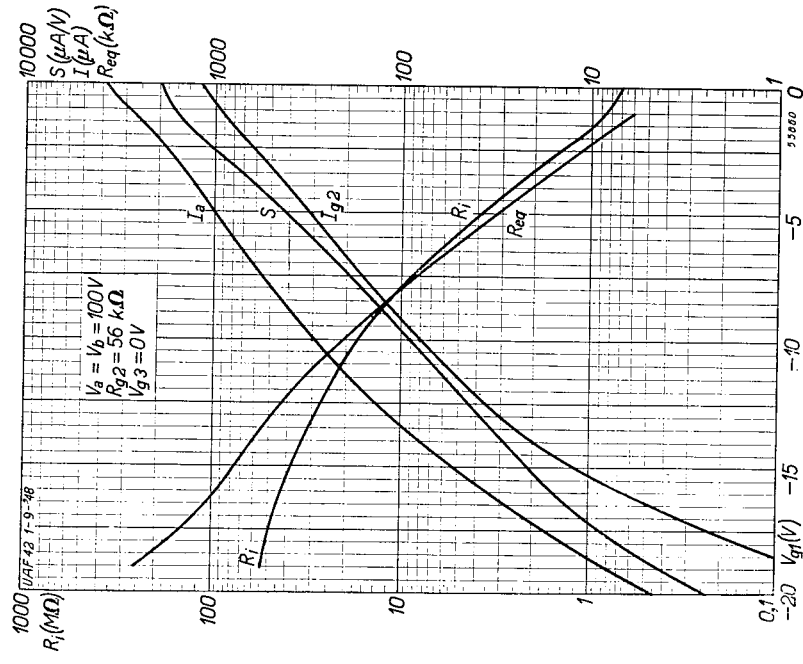

Fig. 10

Anode current (I_a), screen grid current (I_{g2}), mutual conductance (S), internal resistance (R_i) and equivalent noise resistance (R_{eq}) of the pentode section of the UAF 42, as functions of the grid bias (V_{g1}); screen grid resistor $R_{g2} = 56 k\Omega$, anode and supply voltage = 100 V (Fig. 10) and 170 V (Fig. 11).

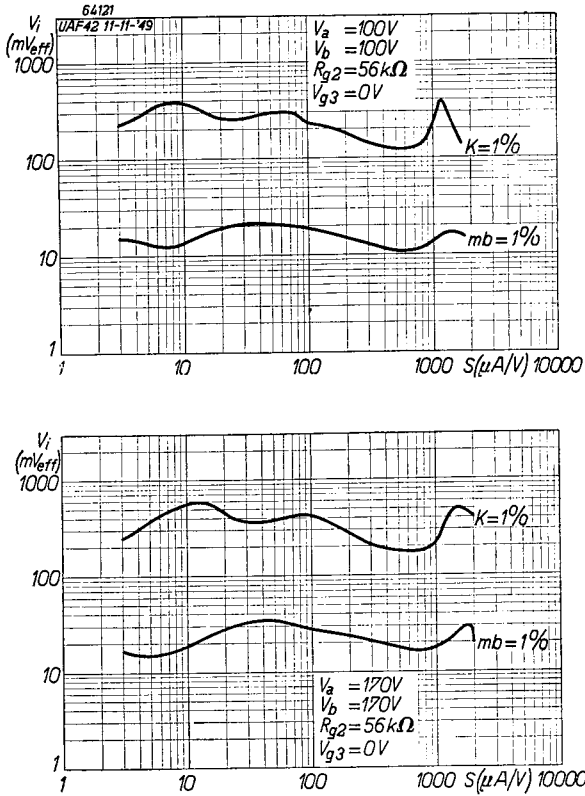

Fig. 12
The effective voltage (V_i) of an interfering R.F. signal on the control grid of the UAF 42, producing 1% cross-modulation; also that of an A.F. signal producing 1% modulation hum (curve $m_b = 1\%$), both as a function of the mutual conductance (S). Screen grid series resistor $R_{g2} = 56 k\Omega$, anode and supply voltage = 100 V (upper figure) and 170 V (lower figure).

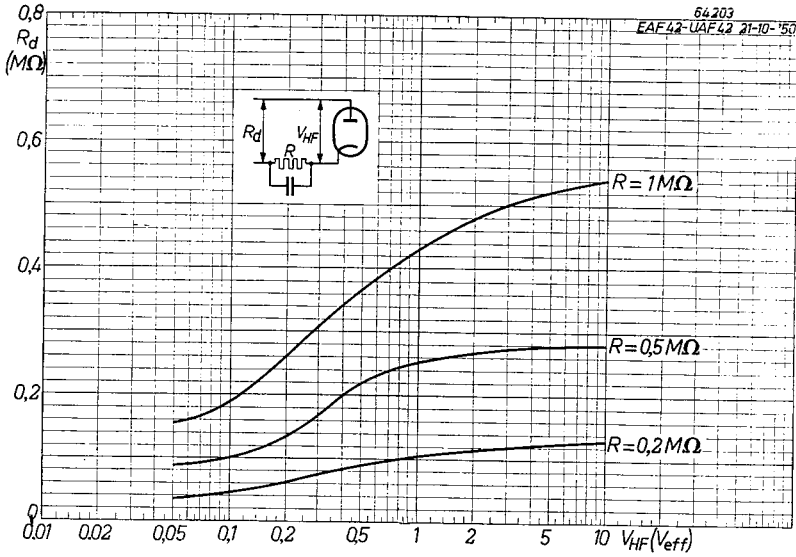

Fig. 13

Damping resistance of the diode of the UAF 42 as a function of the applied R.F. signal, for different values of the series resistor in the detector circuit. For detection characteristic of the diode see Fig. 7 in the description of the EBC 41.

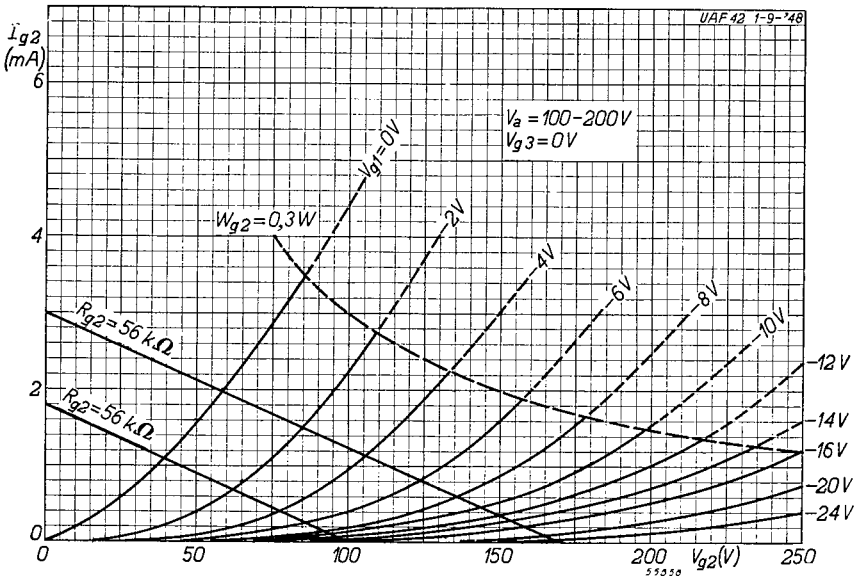

Fig. 14

Screen grid current (I_{g2}) of the pentode section of the UAF 42 as a function of the screen grid voltage (V_{g2}) with grid bias (V_{g1}) as parameter. The maximum permissible screen grid dissipation (0.3 W) is indicated by the dotted line. The straight lines give the working characteristic for a screen grid series resistor of 56 k Ω , at supply voltages of 170 and 100 V.

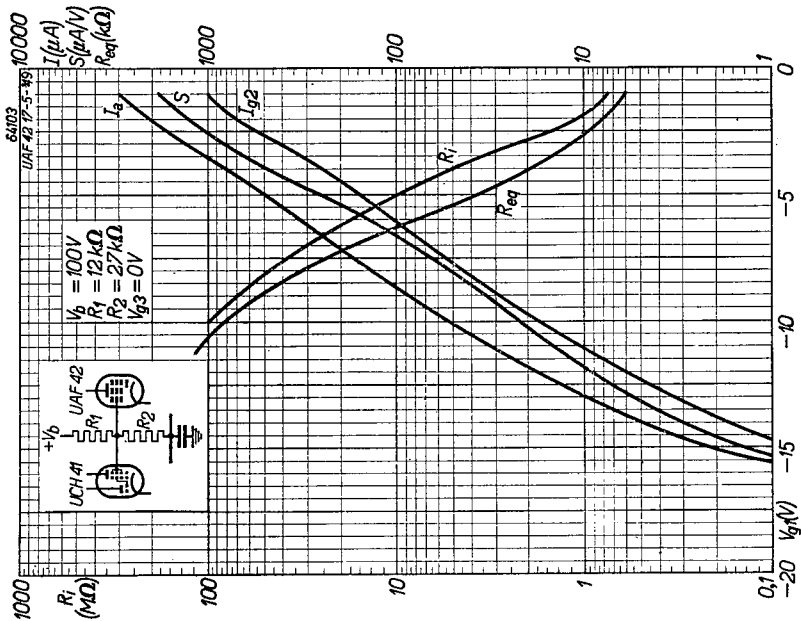

Fig. 15
As Figs. 10 and 11, but with the screen grid voltage of the UAF 42 obtained by means of the same potentiometer as that of the frequency changer UCH 41.

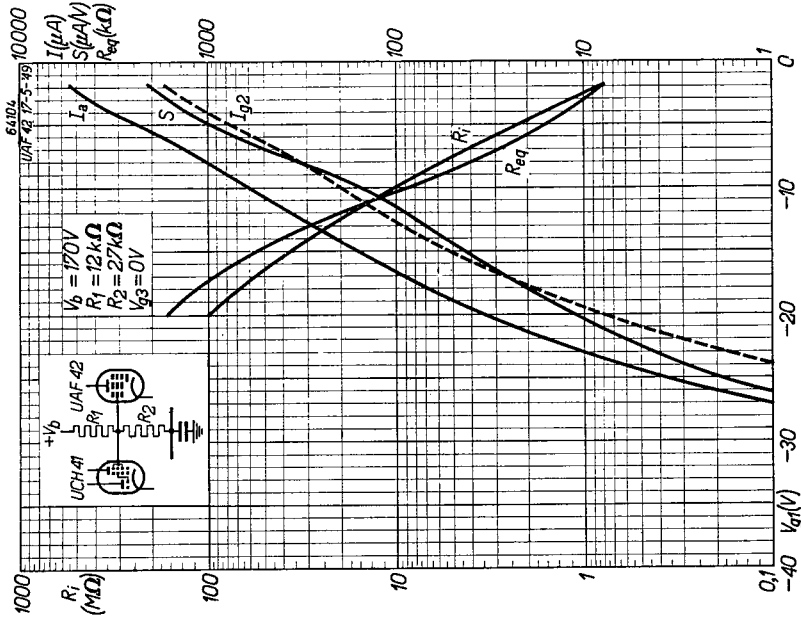

Fig. 16

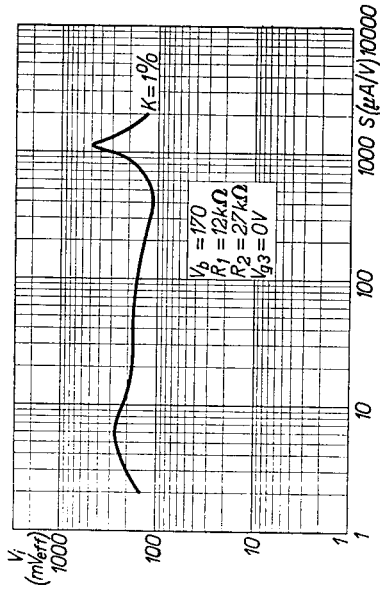
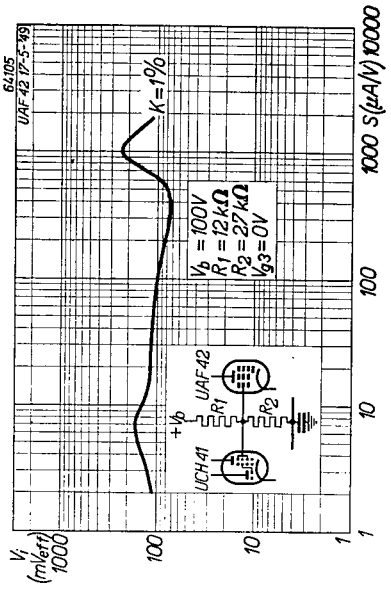

Fig. 17

As Fig. 12, but with the screen grids of the UAF 42 and UCH 41 fed by means of a common potentiometer.

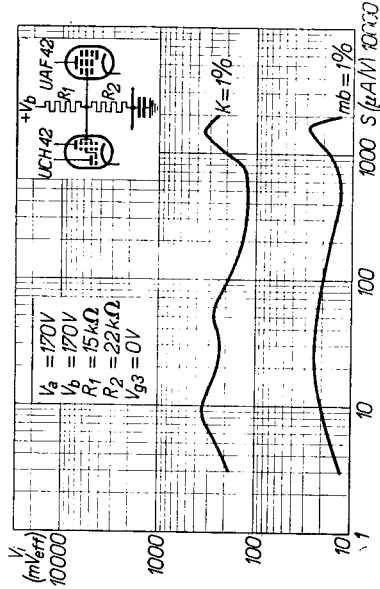
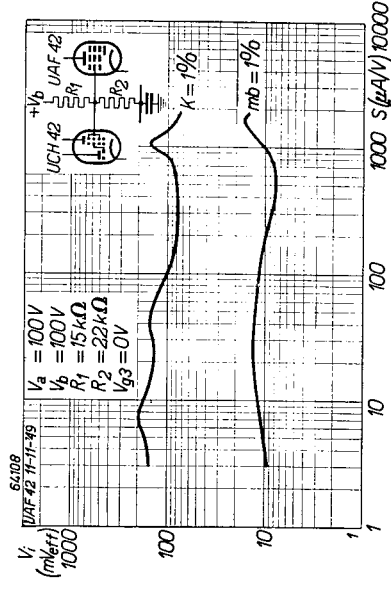

Fig. 18

As Fig. 12, but with the screen grids of the UAF 42 and UCH 42 fed by means of a common potentiometer.

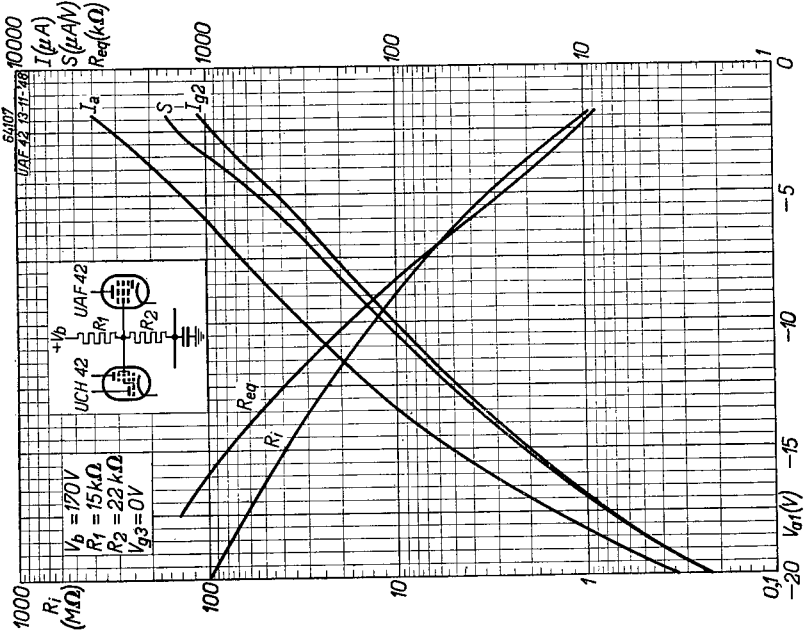

Fig. 20
As Figs. 10 and 11, but with the screen grid feeds of the UAF 42 and UCH 42 taken from a common potentiometer.

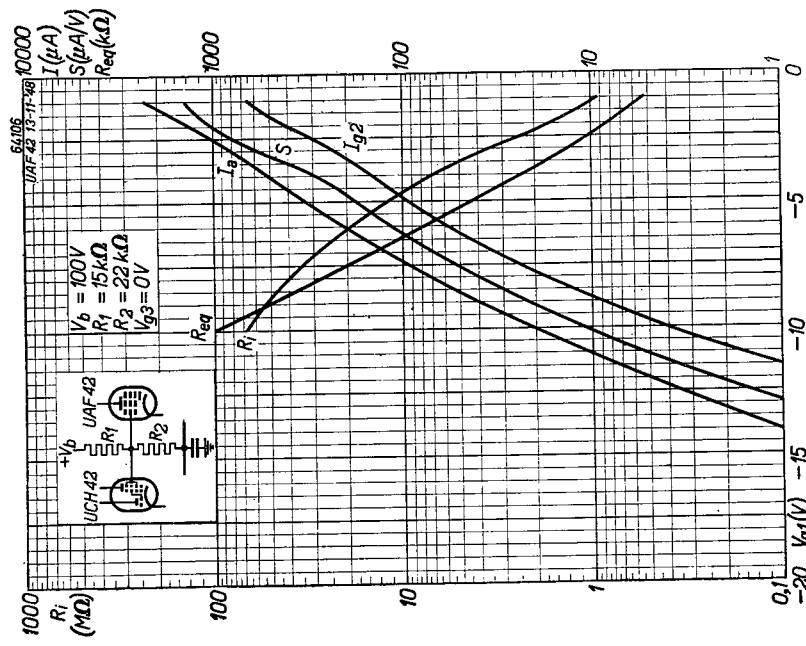

Fig. 19
As Figs. 10 and 11, but with the screen grid feeds of the UAF 42 and UCH 42 taken from a common potentiometer.

UB 41 Double diode

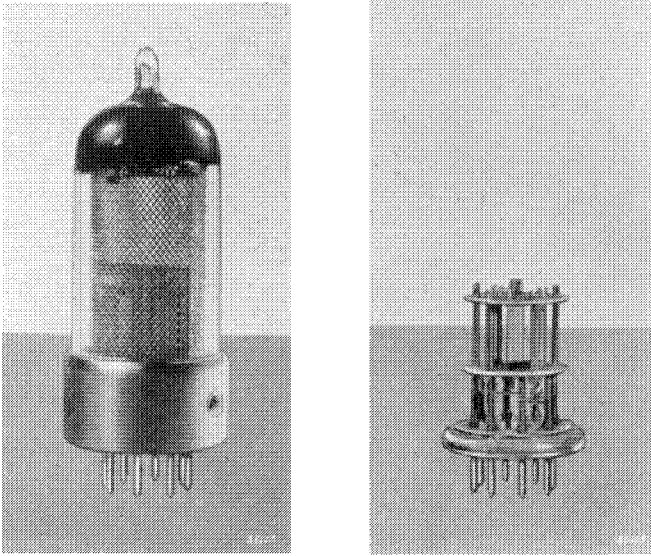

Fig. 1

The UB 41, showing the electrode system (envelope and screening cage removed; approximately actual size).

The UB 41 is an indirectly heated double diode which, as regards properties and applications, is identical with the EB 41. The only difference between these valves lies in the heater, that of the UB 41 being intended for series feed by a current of 100 mA.

TECHNICAL DATA OF THE DOUBLE DIODE UB 41

Heater data

Heating : indirect, A.C. or D.C., series feed

Heater current	I_f	=	100 mA
Heater voltage	V_f	=	19 V

Capacitances (cold valve)

Anode - cathode, diode 1	C_{d1}	=	3.6 pF
Anode - cathode, diode 2	C_{d2}	=	3.6 pF
Cathode - other elements, diode 1	C_{k1}	=	4.5 pF
Cathode - other elements, diode 2	C_{k2}	=	4.5 pF
Anode, diode 1 - anode, diode 2	C_{d1d2}	<	0.03 pF

UB 41

Limiting values (applicable to both systems)

Peak inverse anode voltage	$V_{d\text{ inv } p}$	= max. 420 V
Diode current	I_d	= max. 9 mA
Peak diode current	I_{dp}	= max. 54 mA
Starting point diode current	$V_d(I_d = +0.3 \mu\text{A})$	= max. -1.3 V
Voltage between heater and cathode (cathode negative with respect to heater)	$V_{fk}(k\text{ neg.}, f\text{ pos.})$	= max. 150 V
Peak voltage between heater and cathode (cathode positive with respect to heater)	$V_{fk}(k\text{ neg.}, f\text{ pos.})$	= max. 330 V ¹⁾
External resistance between heater and cathode	R_{fk}	= max. 20 k Ω

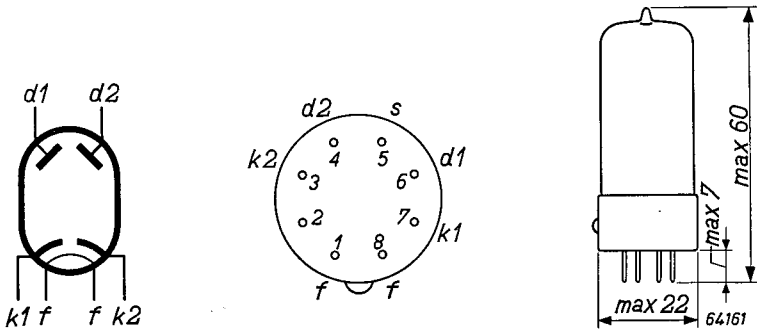

Fig. 2

Electrode arrangement, electrode connections and dimensions in mm of the UB 41.

Characteristics. In view of the fact that the characteristics of the UB 41 are wholly identical with those of the EB 41, reference may be made to the description of the latter.

¹⁾ Max. 165 V D.C. + max. 165 V_{eff} A.C.

UBC 41 Double diode - triode

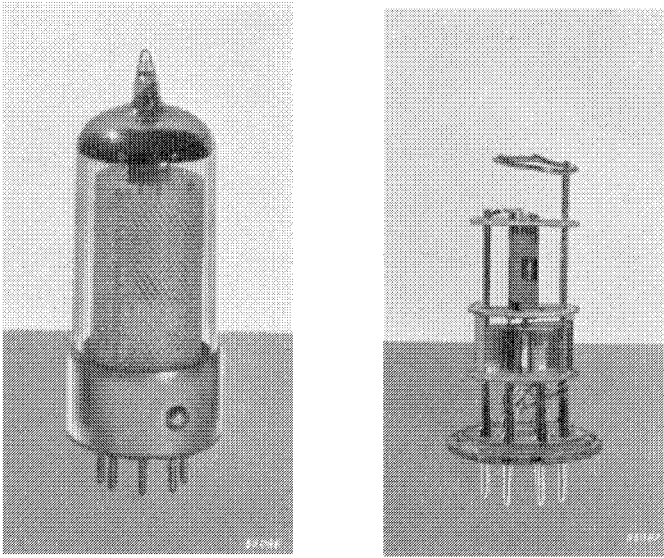

Fig. 1

The UBC 41, showing the electrode system (approximately actual size).

The UBC 41 is a double diode-triode for A.C./D.C. receivers with 100 mA heater circuits. The diode system is intended for detection and A.G.C., leaving the triode system for A.F. amplification.

Since, apart from the heater, the UBC 41 is identical with the EBC 41, reference should be made to the description of the latter valve for further particulars.

It should be noted that, in order to reduce hum, it is advisable so to connect the heater in the heater circuit of the receiver that pin number 1 (see Fig. 2) is as close as possible to the earthed point.

TECHNICAL DATA OF THE DOUBLE DIODE-TRIODE UBC 41

Heater data

Heating: indirect, A.C. or D.C., series feed

Heater current I_f	=	100 mA
Heater voltage V_f	=	14 V

UBC 41

Capacitances (cold valve)

Triode section

Input capacitance	C_g	=	2.7 pF
Output capacitance	C_a	=	1.7 pF
Anode - control grid	C_{ag}	=	1.5 pF
Heater - control grid	C_{gf}	<	0.05 pF

Diode section

Input capacitance, diode 1	C_{d1}	=	0.8 pF
Input capacitance, diode 2	C_{d2}	=	0.7 pF
Between the diode anodes	C_{d1d2}	<	0.3 pF
Between heater and anode of diode 1	C_{d1f}	<	0.1 pF
Between heater and anode of diode 2	C_{d2f}	<	0.05 pF

Between diode and triode sections

Between control grid and anode of diode 1	C_{d1g}	<	0.007 pF
Between control grid and anode of diode 2	C_{d2g}	<	0.03 pF
Between triode anode and anode of diode 1	C_{da1}	<	0.01 pF
Between triode anode and anode of diode 2	C_{d2a}	<	0.01 pF

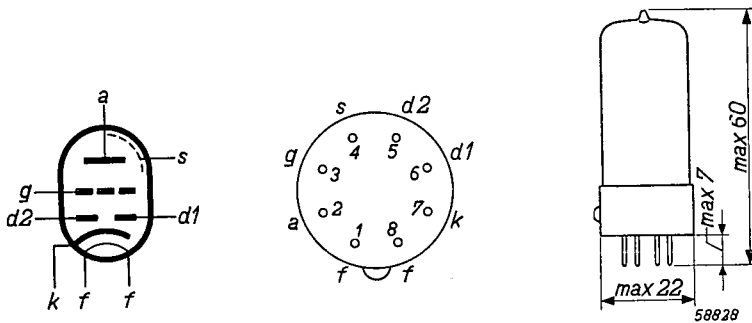

Fig. 2
Electrode arrangement, electrode connections and dimensions in mm of the UBC 41.

Typical characteristics of the triode section

Anode voltage	V_a	= 100 170 V
Grid bias	V_g	= -1.0 -1.55 V
Anode current	I_a	= 0.8 1.5 mA
Mutual conductance	S	= 1.4 1.65 mA/V
Amplification factor	μ	= 70 70
Internal resistance	R_i	= 50 42 k Ω

Operating characteristics of the triode section used as A.F. amplifier (for particulars of this circuit regarding microphony see description of the EBC 41)

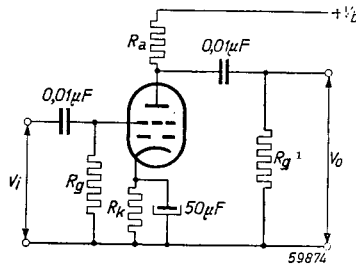

Fig. 3
The UBC 41 used as A.F. amplifier.

V_b (V)	R_a (M Ω)	R_k (k Ω)	R_g (M Ω)	R_g' (M Ω)	I_a (mA)	V_o/V_i	Distortion (%) at $V_o =$		
							3 V_{RMS}	5 V_{RMS}	8 V_{RMS}
170	0.22	5.6	1	0.68	0.28	44	1.1	1.3	1.85
100	0.22	5.6	1	0.68	0.18	41	1.4	1.9	—
170	0.1	3.9	1	0.33	0.45	37	1.1	1.7	2.6
100	0.1	3.9	1	0.33	0.28	34	2.0	3.5	—
170	0.22	0	10	0.68	0.46	48	0.95	1.1	1.3
100	0.22	0	10	0.68	0.21	41	1.45	2.0	—
170	0.1	0	10	0.33	0.82	42	0.75	1.0	1.2
100	0.1	0	10	0.33	0.35	35	1.6	2.8	—

UBC 41

Limiting values of the triode section

Anode voltage, cut-off condition	V_{a_o}	= max. 550 V
Anode voltage	V_a	= max. 250 V
Anode dissipation	W_a	= max. 0.5 W
Cathode current	I_k	= max. 5 mA
Grid current starting point . .	$V_g(I_g = +0.3 \mu A)$	= max. -1.3 V
External resistance between grid and cathode	R_g	= max. 3 M Ω ¹⁾
Voltage between heater and cathode	V_{fk}	= max. 150 V
External resistance between heater and cathode	R_{fk}	= max. 20 k Ω

Limiting values of the diode section

Peak inverse voltage between cathode and diode anodes . .	$V_{d1 \text{ inv } p}$	= max. 350 V
	$V_{d2 \text{ inv } p}$	= max. 350 V
Diode current	I_{d1}	= max. 0.8 mA
	I_{d2}	= max. 0.8 mA
Peak diode current	I_{d1p}	= max. 5 mA
	I_{d2p}	= max. 5 mA
Diode current starting point . .	$V_{d1}(I_{d1} = +0.3 \mu A)$	= max. -1.3 V
	$V_{d2}(I_{d2} = +0.3 \mu A)$	= max. -1.3 V

¹⁾ This value is applicable where grid bias is derived from a cathode resistor. If the grid leak is the only source of the bias (i.e. no cathode resistor or battery source), the maximum value for R_g is 22 M Ω .

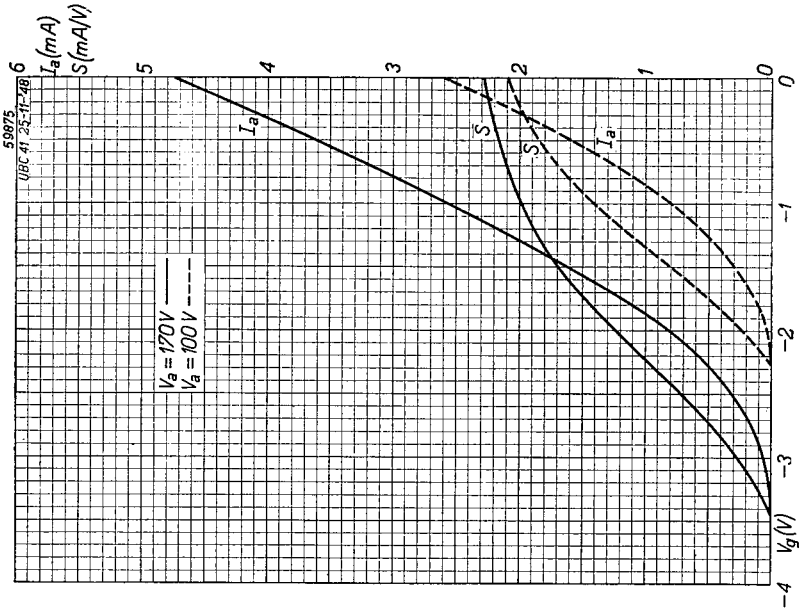

Fig. 4
Anode current (I_a) and mutual conductance (S) of the UBC 41 as functions of the grid bias (V_g) with anode voltages of 100 V and 170 V.

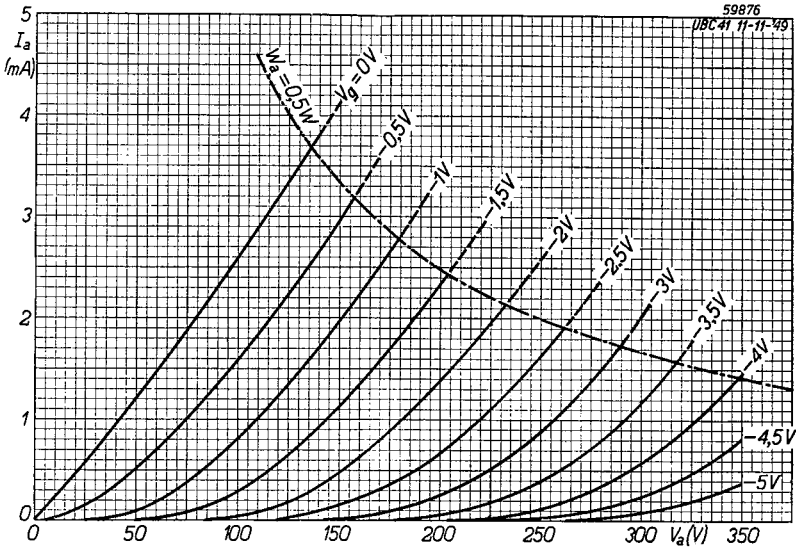

Fig. 5
 I_a/V_a characteristics of the UBC 41. The dot-dash line indicates the maximum permissible anode dissipation ($W_a = 0.5W$).

For the diode characteristics see Figs. 6 and 7 in the description of the EBC 41.

UCH 41

UCH 41 Triode-hexode frequency changer

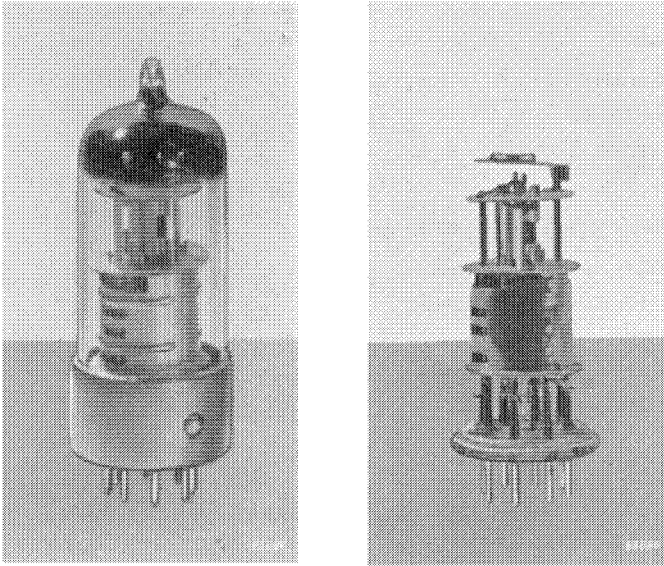

Fig. 1
The UCH 41, showing the electrode system (approximately actual size).

The triode-hexode UCH 41 is a frequency changer with a conversion conductance of $450 \mu\text{A/V}$ at an applied voltage of 170 V, or $320 \mu\text{A/V}$ at 100 V. Further particulars will be found in the description of the ECH 41, the corresponding E-type valve.

TECHNICAL DATA OF THE TRIODE-HEXODE UCH 41

Heater data

Heating : indirect, A.C. or D.C., series feed

Heater current I_f	=	100 mA
Heater voltage V_f	=	14 V

Capacitances (cold valve)

Hexode section

Input capacitance C_{g1}	=	3.4 pF
Output capacitance C_a	=	6.0 pF
Anode - control grid C_{ag1}	<	0.1 pF
Heater - control grid C_{o1f}	<	0.15 pF

Triode section

Input capacitance	C_{gT+g3}	=	4.9 pF
Output capacitance	C_a	=	1.5 pF
Anode - grid	$C_{(gT+g3)a}$	=	1.2 pF

Between triode and hexode sections

Hexode control grid - triode grid	$C_{g1H-(gT+g3)}$	<	0.35 pF
Hexode anode - triode grid . .	$C_{aH-(gT+g3)}$	<	0.2 pF

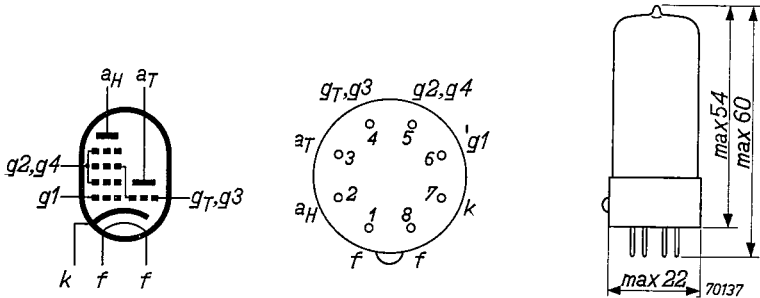

Fig. 2

Electrode arrangement, electrode connections and maximum dimensions in mm of the UCH 41.

Operating characteristics of the hexode section used as frequency changer (screen grids fed by means of a potentiometer ; see Figs. 6—13 incl.)

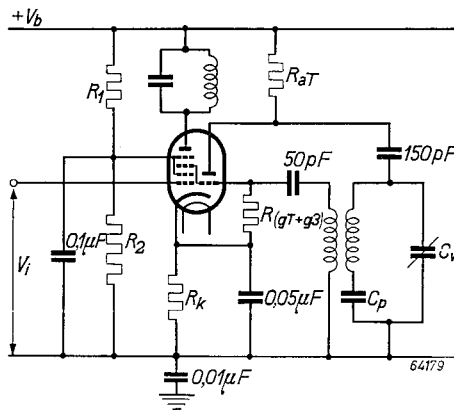

Fig. 3

UCH 41

Anode and supply voltage	$V_a = V_b =$	100	170	V		
Resistor between supply voltage and screen grids	$R_1 =$	22	22	k Ω		
Resistor between screen grids and chassis	$R_2 =$	47	47	k Ω		
Bias resistor	$R_k =$	200	200	Ω		
Oscillator grid leak	$R_{gT+g3} =$	20	20	k Ω		
Oscillator grid current	$I_{gT+g3} =$	200	320	μ A		
Grid bias	$V_{g1} =$	$\overbrace{-1.0 \quad -14}$	$\overbrace{-1.8 \quad -22}$	V		
Screen grid voltage	$V_{g2+g4} =$	52	68	87	116	V
Anode current	$I_a =$	1.0	—	2.2	—	mA
Screen grid current	$I_{g2+g4} =$	1.0	—	1.9	—	mA
Conversion conductance	$S_c =$	320	3.2	450	4.5	μ A/V
Internal resistance	$R_i =$	1.4	>5	1.2	>5	M Ω
Equivalent noise resistance	$R_{eq} =$	115	—	145	—	k Ω

Anode and supply voltage	$V_a = V_b =$	200	V	
Resistor between supply voltage and screen grids	$R_1 =$	22	k Ω	
Resistor between screen grids and chassis	$R_2 =$	47	k Ω	
Bias resistor	$R_k =$	225	Ω	
Oscillator grid leak	$R_{gT+g3} =$	20	k Ω	
Oscillator grid current	$I_{gT+g3} =$	360	μ A	
Grid bias	$V_{g1} =$	$\overbrace{-2.2 \quad -27}$	V	
Screen grid voltage	$V_{g2+g4} =$	105	136	V
Anode current	$I_a =$	3.0	—	mA
Screen grid current	$I_{g2+g4} =$	2.1	—	mA
Conversion conductance	$S_c =$	500	5	μ A/V
Internal resistance	$R_i =$	1.0	>5	M Ω
Equivalent noise resistance	$R_{eq} =$	220	—	k Ω

Typical characteristics of the triode section (see Figs. 15 and 16)

Anode voltage	$V_a =$	100	V
Grid voltage	$V_{gT+g3} =$	0	V
Anode current	$I_a =$	8.5	mA
Mutual conductance	$S =$	1.9	mA/V
Amplification factor	$\mu =$	19	

Operating characteristics of the triode section used as oscillator

(see Figs. 17 and 18)

Supply voltage	$V_b =$	100	170	200	V
Anode resistor	$R_a =$	10	10	20	k Ω
Anode current	$I_a =$	2.8	4.9	4.6	mA
Oscillator grid leak	$R_{gT+g3} =$	20	20	20	k Ω
Oscillator grid current	$I_{gT+g3} =$	200	320	360	μ A
Oscillator voltage	$V_{osc} =$	4	7	8	V _{RMS}
Effective slope	$S_{eff} =$	0.56	0.6	0.5	mA/V

Operating characteristics of the UCH 41 used as phase inverter (see Fig. 4)

Supply voltage	Total current	Amplification	Distortion (%) at an output voltage of	
			5 V _{RMS}	10 V _{RMS}
100	1.2	10	1.5	—
170	2.0	10	1.0	1.8

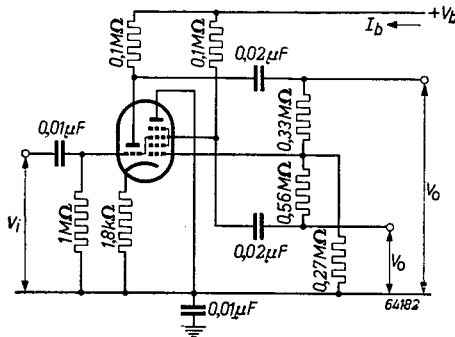

Fig. 4
The UCH 41 used as phase inverter.

Operating characteristics of the hexode section used as frequency changer with screen grids, fed, together with that of the UAF 42, by means of a common potentiometer (see Figs. 19—21)

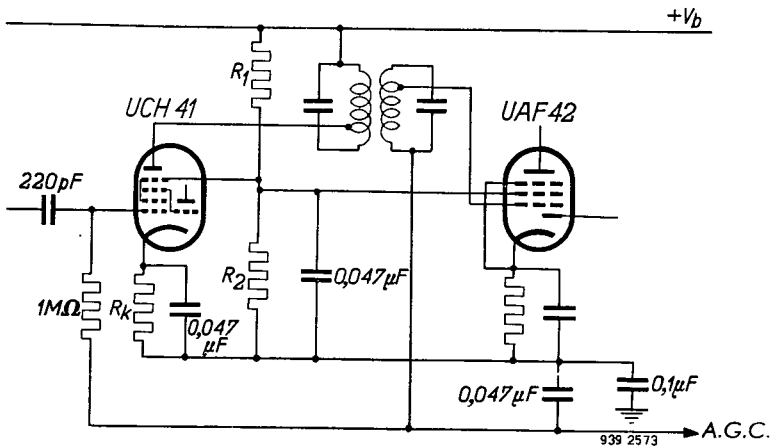

Fig. 5

UCH 41

Anode and supply voltage . . .	$V_a = V_b =$	100	170	V	
Resistor between supply voltage and screen grids	$R_1 =$	12	12	k Ω	
Resistor between screen grids and chassis	$R_2 =$	27	27	k Ω	
Bias resistor	$R_k =$	200	200	Ω	
Oscillator grid leak	$R_{gT+g3} =$	20	20	k Ω	
Oscillator grid current	$I_{gT+g3} =$	200	320	μ A	
Grid bias	$V_{g1} =$	-1.0 -10.5 -1.8 -18 V			
Screen grid voltage	$V_{g2+g4} =$	53	69	87	117 V
Anode current	$I_a =$	1.0	—	2.2	— mA
Screen grid current	$I_{g2+g4} =$	1.0	—	1.9	— mA
Conversion conductance	$S_c =$	320	10	450	11 μ A/V
Internal resistance	$R_i =$	1.4	—	1.2	— M Ω
Equivalent noise resistance	$R_{eq} =$	115	—	145	— k Ω

Operating characteristics of the hexode section of the UCH 41 used as frequency changer; screen grid voltage, together with that of the I.F. amplifier UF 41 derived from a common potentiometer (circuit corresponding to that shown in Fig. 5)

Anode and supply voltage . . .	$V_a = V_b =$	100	170	V	
Potentiometer for screen grid feed	$R_1 =$	12	12	k Ω	
	$R_2 =$	27	27	k Ω	
Bias resistor	$R_k =$	200	200	Ω	
Oscillator grid leak	$R_{gT+g3} =$	20	20	k Ω	
Oscillator grid current	$I_{gT+g3} =$	200	320	μ A	
Grid bias	$V_{g1} =$	-1.0 -12 -1.8 -20 V			
Screen grid voltage	$V_{g2+g4} =$	53	69	87	117 V
Anode current	$I_a =$	1.0	—	2.2	— mA
Screen grid current	$I_{g2+g4} =$	1.0	—	1.9	— mA
Conversion conductance	$S_c =$	320	5.5	450	7 μ A/V
Internal resistance	$R_i =$	1.4	>5	1.2	>5 M Ω
Equivalent noise resistance	$R_{eq} =$	115	—	145	— k Ω

Limiting values of the hexode section

Anode voltage, valve biased to cut-off	V_{a0}	= max.	550 V
Anode voltage	V_a	= max.	250 V
Anode dissipation	W_a	= max.	0.8 W
Screen grid voltage, valve biased to cut-off	$V_{(g2+g4)0}$	= max.	550 V
Screen grid voltage	V_{g2+g4}	= max.	125 V
Screen grid dissipation	W_{g2+g4}	= max.	0.3 W
Grid current starting point	$V_{g1}(I_{g1} = +0.3\mu A)$	= max.	-1.3 V
Cathode current	I_k	= max.	7 mA
External resistance between grid 1 and cathode	R_{g1}	= max.	3 M Ω

External resistance between grid 3 and cathode	R_{g3}	= max.	3 M Ω
External resistance between heater and cathode	R_{fk}	= max.	20 k Ω
Voltage between heater and cathode	V_{fk}	= max.	150 V

Limiting values of the triode section

Anode voltage, valve biased to cut-off	V_{a_0}	= max.	550 V
Anode voltage	V_a	= max.	175 V
Anode dissipation	W_a	= max.	0.75 W
Grid current starting point	$V_g(I_g = +0.3 \mu\text{A})$	= max.	-1.3 V
Cathode current	I_k	= max.	5.5 mA
External resistance between grid and cathode	R_g	= max.	3 M Ω
External resistance between heater and cathode	R_{fk}	= max.	20 k Ω
Voltage between heater and cathode	V_{fk}	= max.	150 V

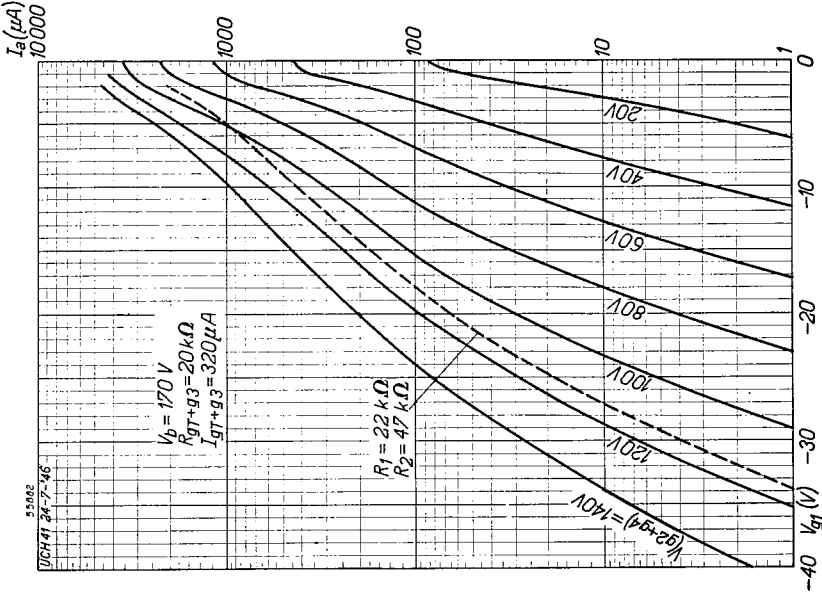

Fig. 7

Anode current (I_a) of the UCH 41, measured on oscillating valve, as a function of the grid bias (V_{g1}) with screen grid voltage (V_{g2+g3}) as parameter. The dotted curves represent the anode current when the screen grid voltage is derived from a potentiometer (R_1, R_2 , see Fig. 3). Fig. 6: supply voltage $V_b = 100 \text{ V}$; Fig. 7: $V_b = 170 \text{ V}$.

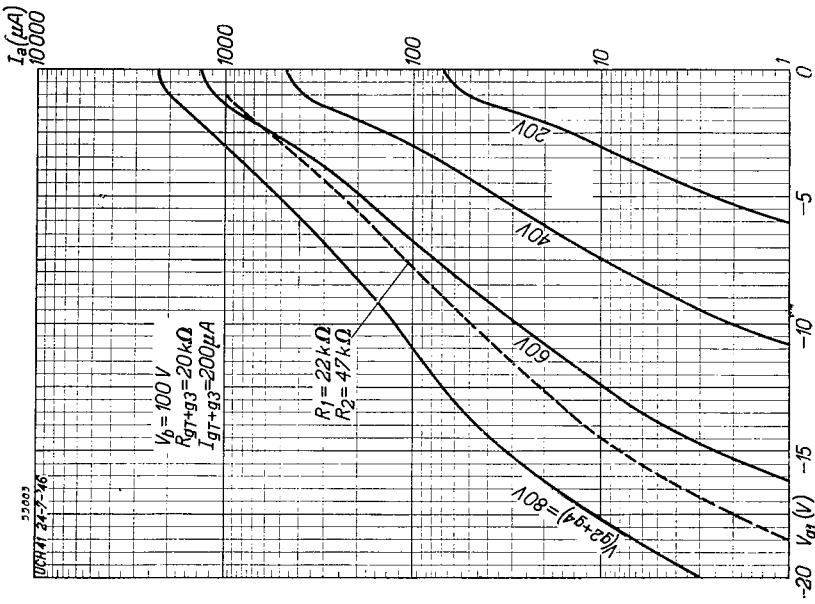

Fig. 6

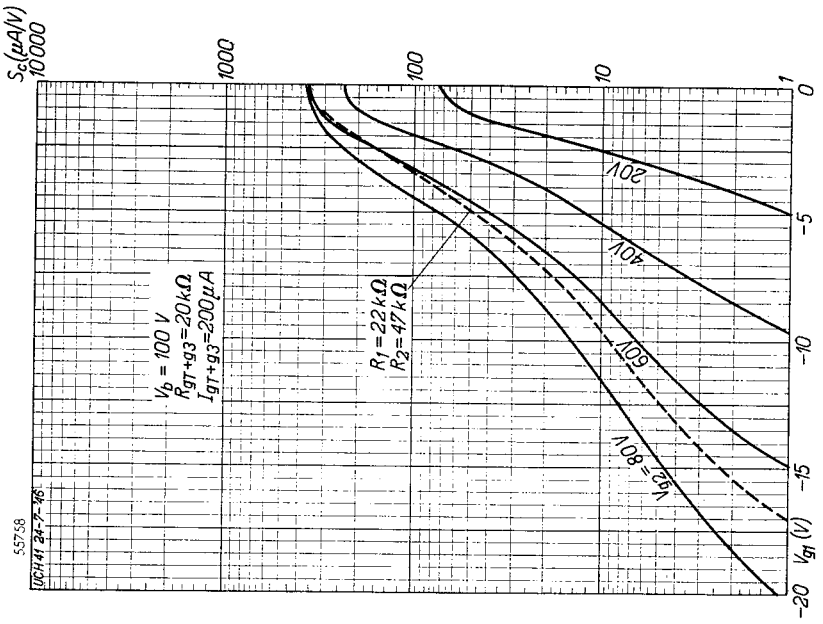
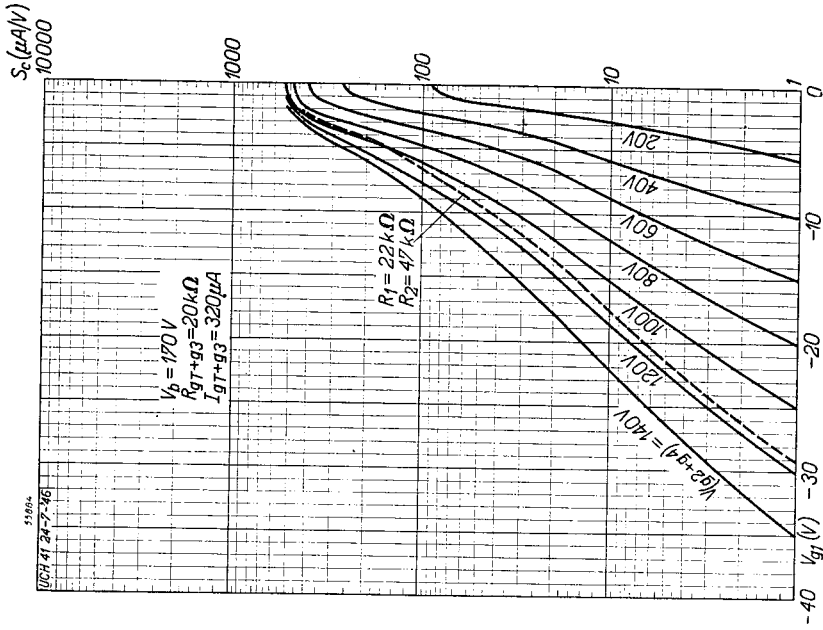

Fig. 8
 Conversion conductance (S_c) of the UCH 41, measured on oscillating valve, as a function of the grid bias (V_{g1}), with screen grid voltage (V_{g2+g4}) as parameter. The dotted curves represent the conversion conductance when the screen grids are fed by means of a potentiometer (R_1, R_2 , see Fig. 3). Fig. 8 : supply voltage, $V_b = 100 \text{ V}$; Fig. 9 : $V_b = 170 \text{ V}$.

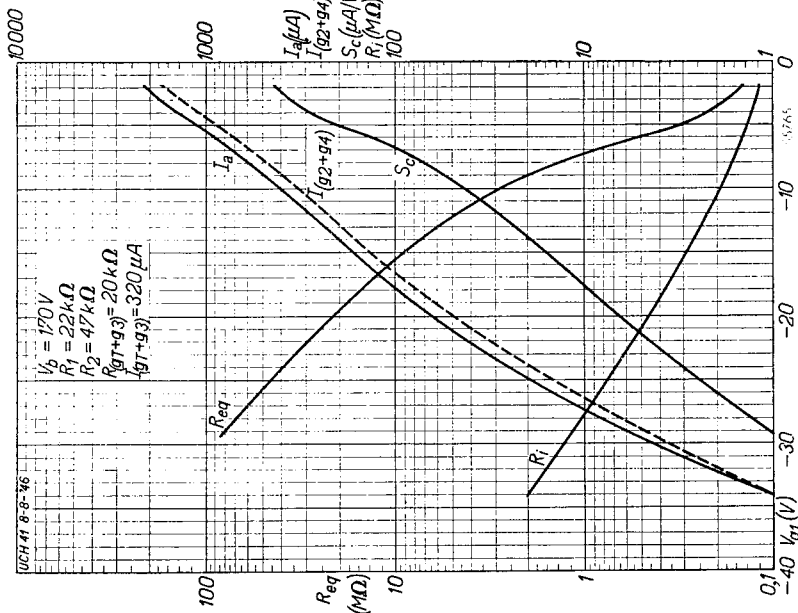

Fig. 11

Fig. 11: $V_b = 170\text{ V}$. Anode current (I_a), screen grid current (I_{g2+g4}), conversion conductance (S_c), internal resistance (R_i) and equivalent noise resistance (R_{eq}) of the UCH 41, as functions of the grid bias (V_{gt}). Measurements taken from oscillating valve in circuit shown in Fig. 3.

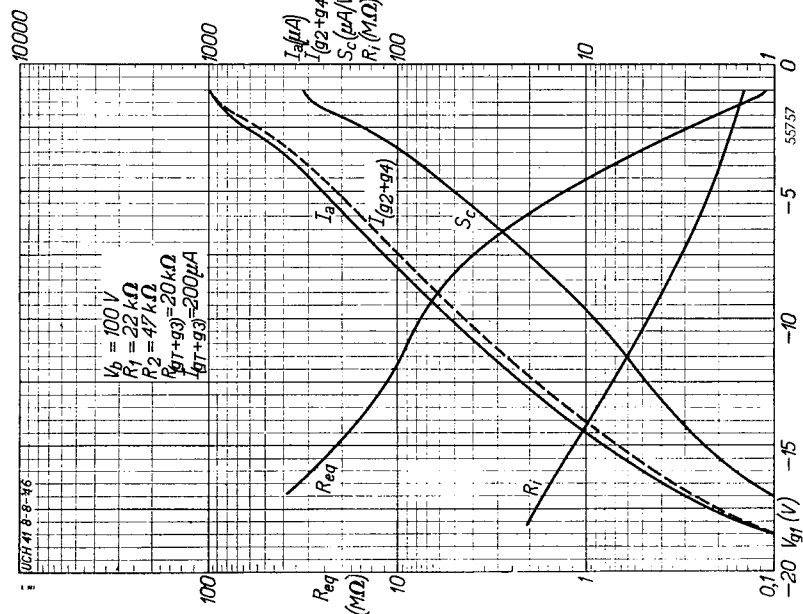

Fig. 10

Fig. 10: $V_b = 100\text{ V}$. Anode current (I_a), screen grid current (I_{g2+g4}), conversion conductance (S_c), internal resistance (R_i) and equivalent noise resistance (R_{eq}) of the UCH 41, as functions of the grid bias (V_{gt}). Measurements taken from oscillating valve in circuit shown in Fig. 3.

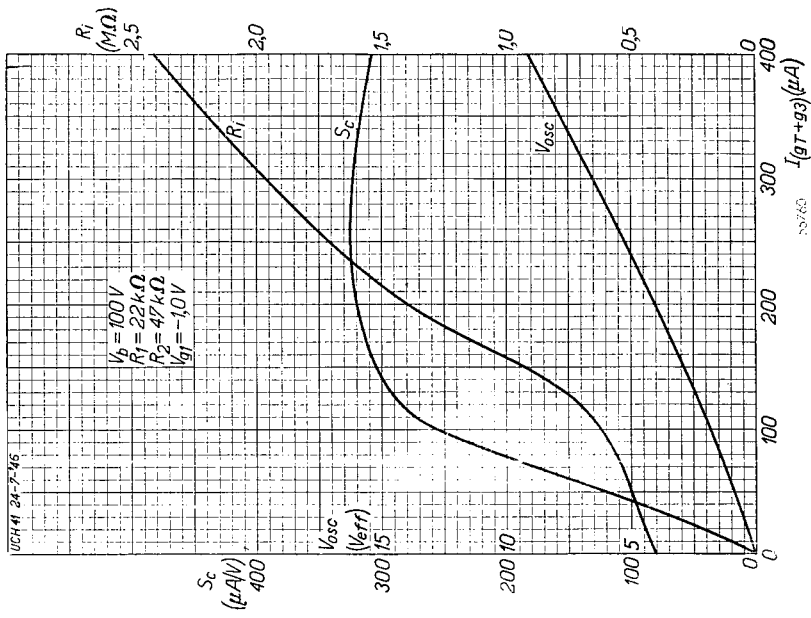

Fig. 12

Conversion conductance (S_c), oscillator voltage (V_{osc}) and internal resistance (R_i) of the UCH 41, as functions of the oscillator grid current (I_{gr+g3}). Relative to the circuit depicted in Fig. 3. Fig. 12 : $V_b=100 \text{ V}$; Fig. 13 : $V_b=170 \text{ V}$.

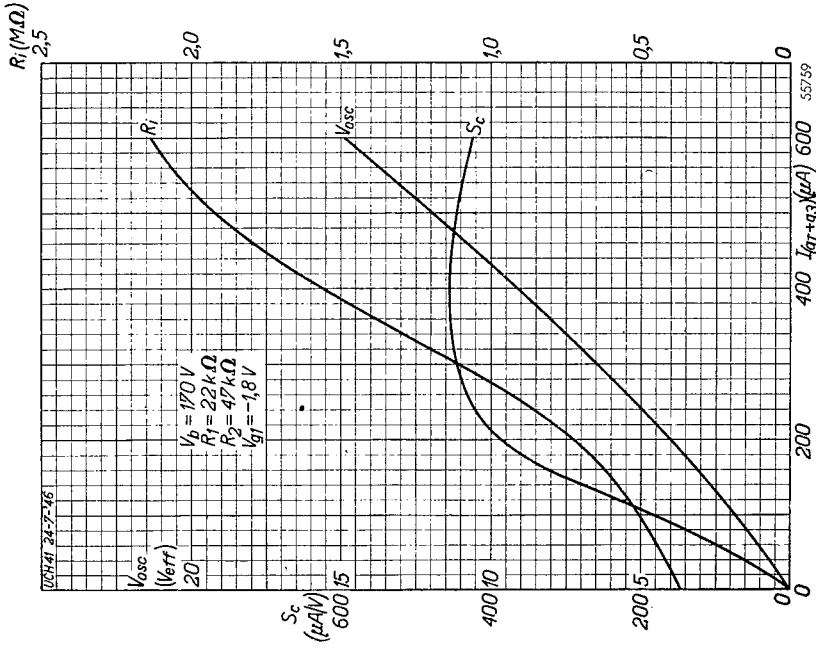

Fig. 13

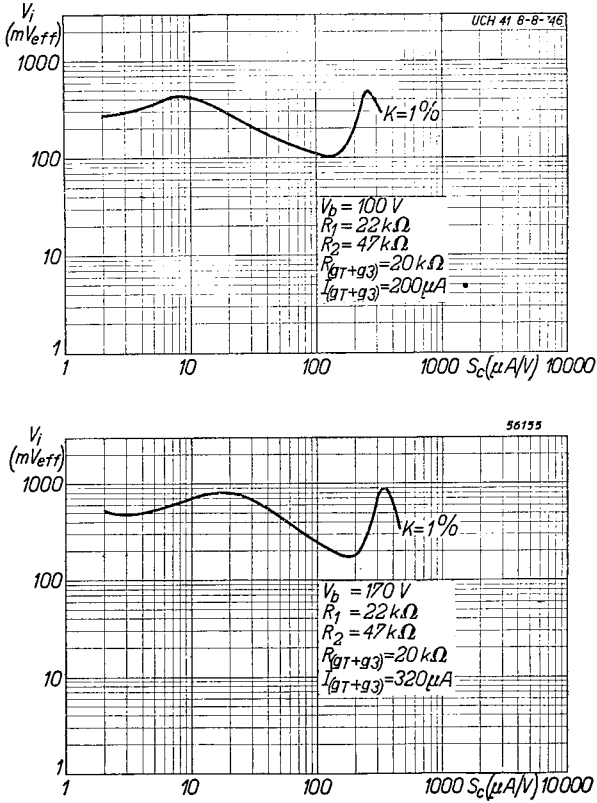

Fig. 14

The effective voltage (V_i) of an interfering signal at the control grid of the UCH 41, producing 1% cross modulation, as a function of the conversion conductance (S_c). Measurements taken in the circuit shown in Fig. 3. Upper figure: $V_b=100 V$; lower figure: $V_b=170 V$.

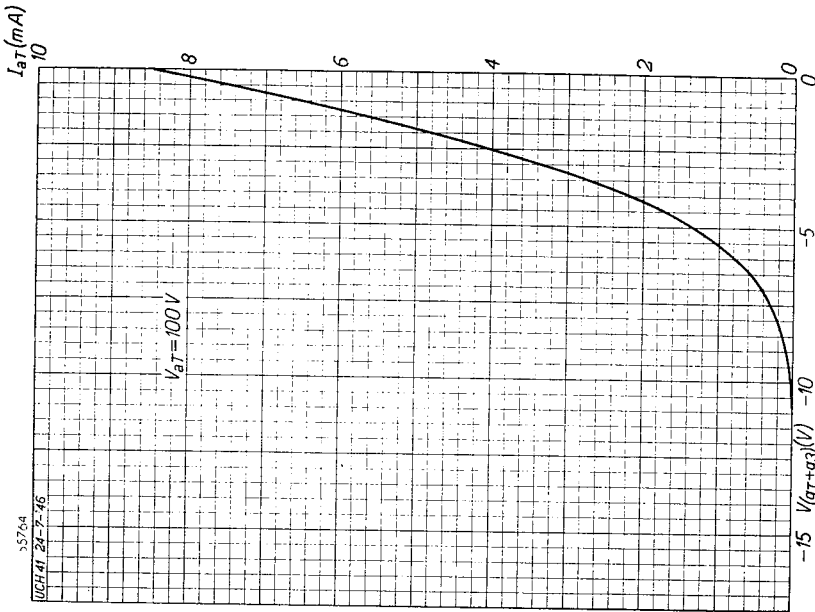

Fig. 15
 I_a/V_g characteristic of the triode system of the UCH 41.

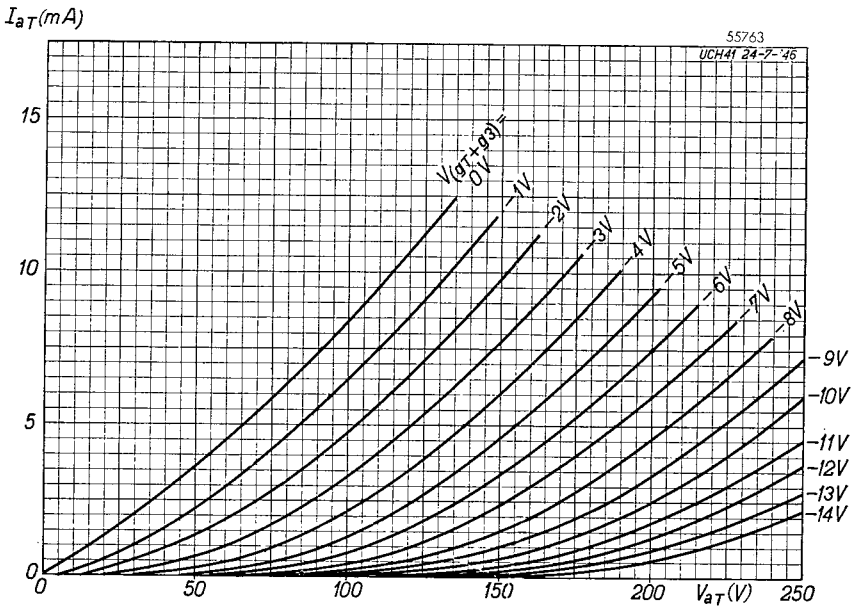

Fig. 16
 I_a/V_a characteristics of the triode system of the UCH 41.

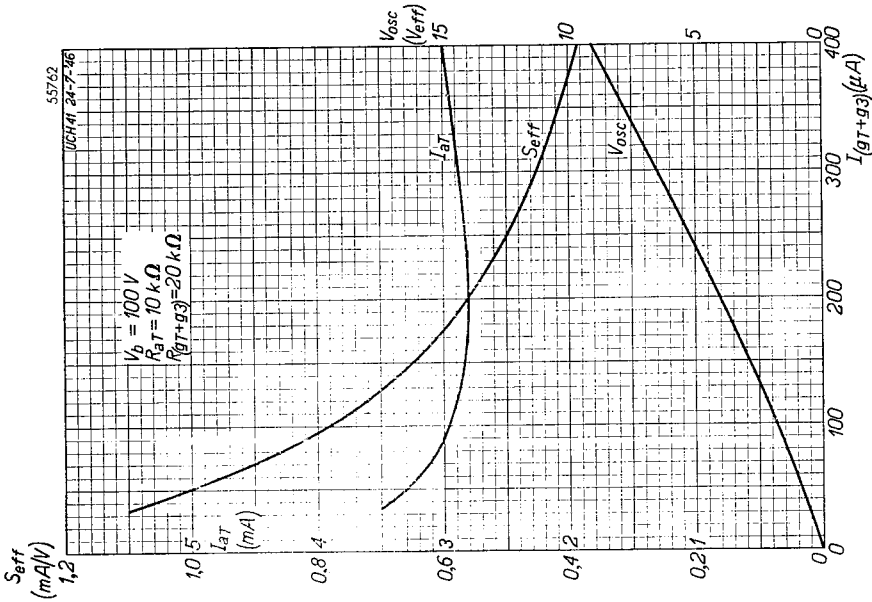

Fig. 17

Anode current (I_a), oscillator voltage (V_{osc}) and effective slope (S_{eff}) of the triode system of the UCH 41, as functions of the oscillator grid current ($I_{gr} + I_{g3}$). Fig. 17: supply voltage $V_b = 100\text{ V}$; Fig. 18: $V_b = 170\text{ V}$.

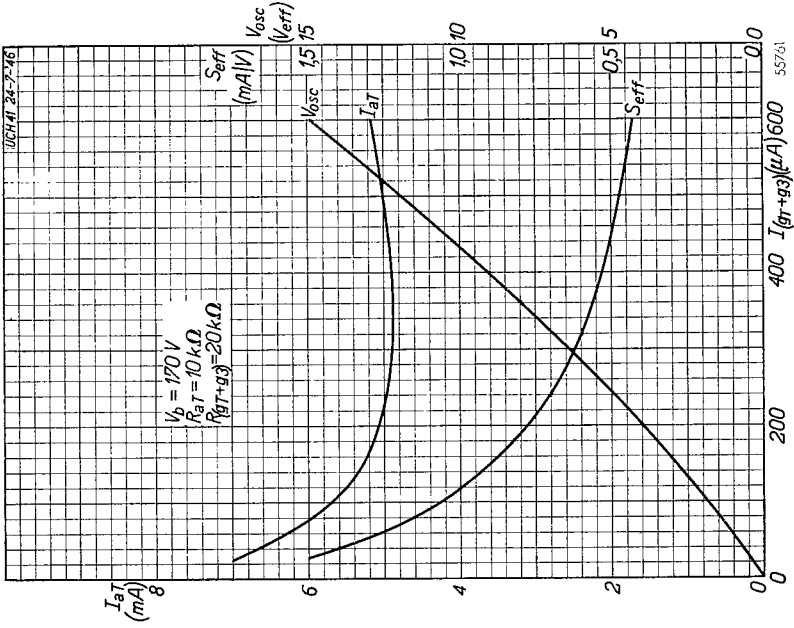

Fig. 18

Anode current (I_a), oscillator voltage (V_{osc}) and effective slope (S_{eff}) of the triode system of the UCH 41, as functions of the oscillator grid current ($I_{gr} + I_{g3}$). Fig. 17: supply voltage $V_b = 100\text{ V}$; Fig. 18: $V_b = 170\text{ V}$.

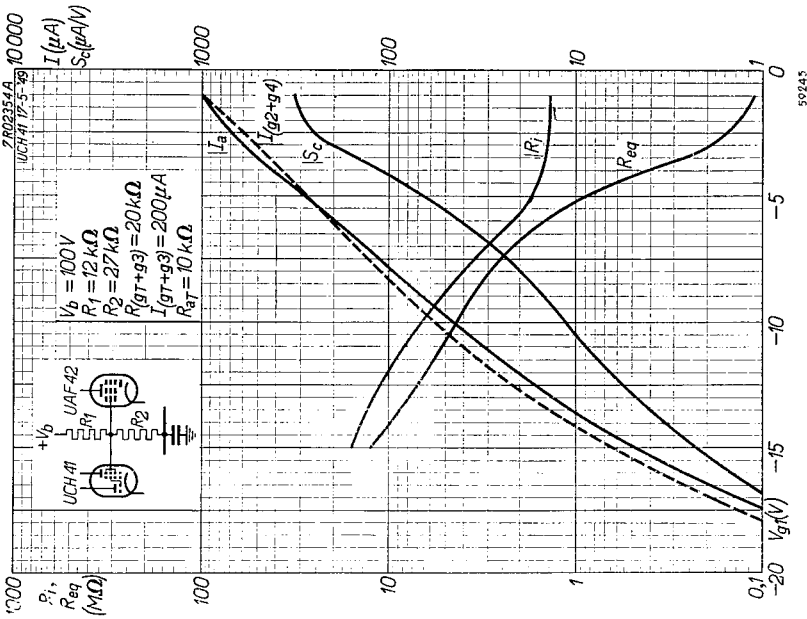

Fig. 19

As Fig. 10 and Fig. 11, but with the screen grids of the UCH 41, together with that of the UAF 42, fed by means of a common potentiometer. Measurements taken in the circuit shown in Fig. 5. Fig. 19: supply voltage $V_b = 100\text{ V}$; Fig. 20: $V_b = 170\text{ V}$.

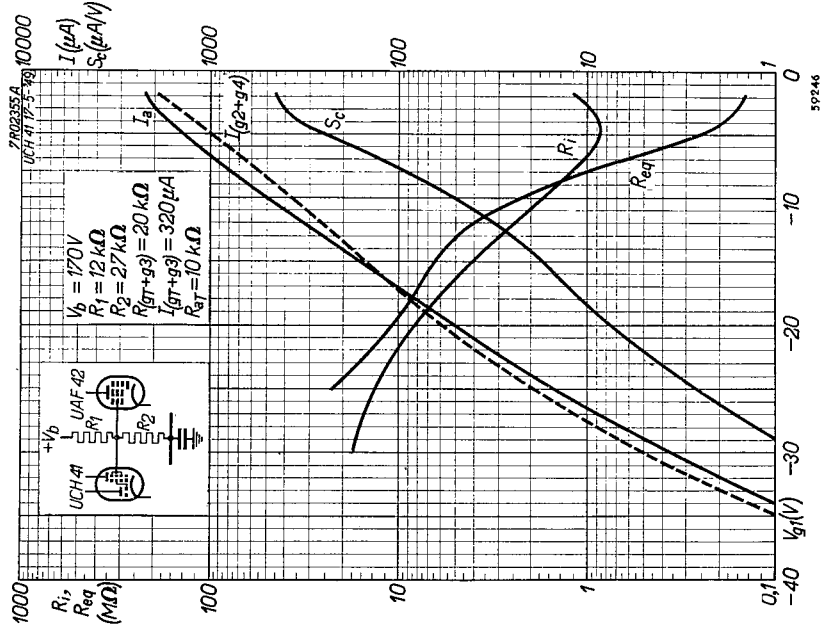

Fig. 20

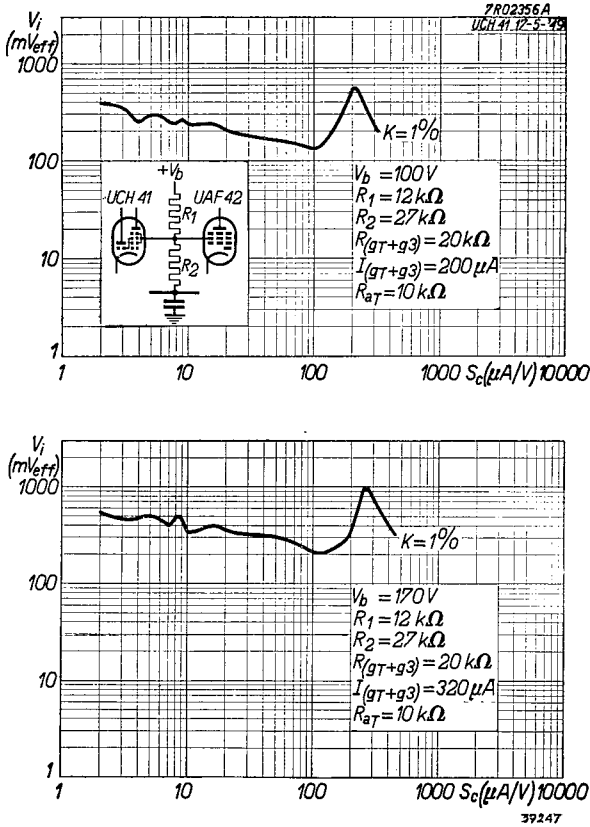

Fig. 21
As Fig. 14, but with screen grids of the UCH 41, together with that of the UAF 42, fed by means of a common potentiometer.

UCH 42 Triode-hexode frequency changer

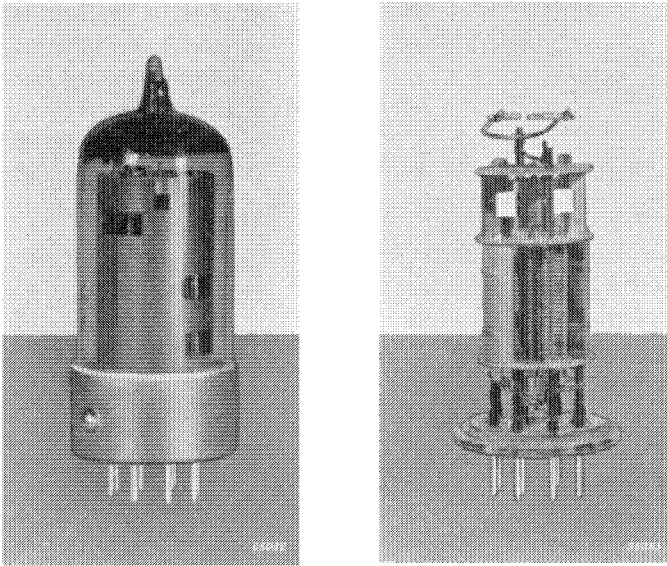

Fig. 1
The UCH 42, showing the electrode system (approximately actual size).

The triode-hexode UCH 42 is a frequency changer with a conversion conductance of $670 \mu\text{A/V}$ at an applied voltage of 170 V, or $530 \mu\text{A/V}$ at 100 V. It is designed for A.C./D.C. receivers in which the heaters, connected in series, take a current of 100 mA.

Further particulars will be found in the description of the ECH 42, the corresponding E-type valve.

TECHNICAL DATA OF THE TRIODE-HEXODE UCH 42

Heater data

Heating : indirect, A.C. or D.C., series feed

Heater current	I_f	=	100 mA
Heater voltage	V_f	=	14 V

Capacitances (measured on cold valve)

Hexode section

Input capacitance	C_{g1}	=	4.0 pF
Output capacitance	C_a	=	9.4 pF
Anode - control grid	C_{ag1}	<	0.1 pF
Heater - control grid	C_{g1f}	<	0.15 pF

UCH 42

Triode section

Input capacitance	C_{gT+g3}	=	5.9 pF
Output capacitance	C_a	=	2.4 pF
Anode - grid	$C_{(gT+g3)a}$	=	1.3 pF

Between triode and hexode sections

Hexode control grid - triode grid	$C_{g1H-(gT+g3)}$	<	0.35 pF
Hexode anode - triode grid	$C_{aH-(gT+g3)}$	<	0.2 pF

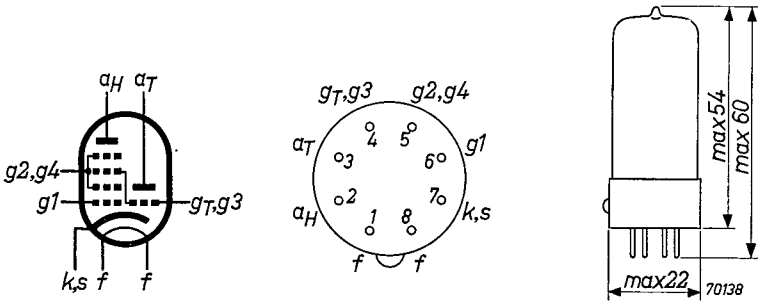

Fig. 2

Electrode arrangement, electrode connections and maximum dimensions in mm of the UCH 42.

Operating characteristics of the hexode section used as frequency changer (screen grids fed by means of a potentiometer, see Figs. 6 to 15 incl.)

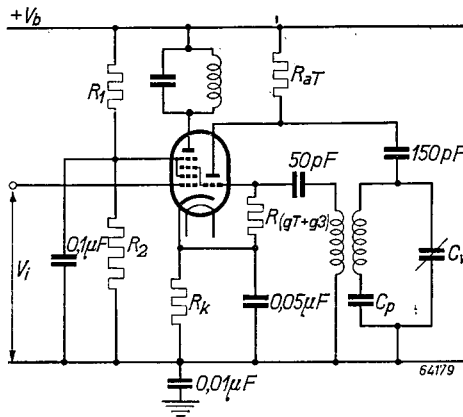

Fig. 3

Anode and supply voltage	$V_a = V_b =$	100	170	V
Resistor between supply voltage and screen grids	$R_1 =$	18	18	kΩ
Resistor between screen grids and chassis	$R_2 =$	27	27	kΩ
Bias resistor	$R_b =$	180	180	Ω
Oscillator grid leak	$R_{gT+g3} =$	22	22	kΩ
Oscillator grid current	$I_{gT+g3} =$	175 ¹⁾	350 ¹⁾	μA
Grid bias	$V_{g1} =$	-1.0 — 13.5	-1.85 — 25	V
Screen grid voltage	$V_{g2+g4} =$	43	57	70 100 V
Anode current	$I_a =$	1.2	—	2.1 — mA
Screen grid current	$I_{g2+g4} =$	1.46	—	2.6 — mA
Conversion conductance	$S_c =$	530	5.3	670 6.7 μA/V
Internal resistance	$R_i =$	>1	>5	>1 >5 MΩ
Equivalent noise resistance	$R_{eq} =$	50	—	85 — kΩ

Anode and supply voltage	$V_a = V_b =$		200	V
Resistor between supply voltage and screen grids	$R_1 =$		18	kΩ
Resistor between screen grids and chassis	$R_2 =$		27	kΩ
Bias resistor	$R_b =$		180	Ω
Oscillator grid leak	$R_{gT+g3} =$		22	kΩ
Oscillator grid current	$I_{gT+g3} =$		350 ¹⁾	μA
Grid bias	$V_{g1} =$		-2 — 27.5	V
Screen grid voltage	$V_{g2+g4} =$		85	119 V
Anode current	$I_a =$		3.0	— mA
Screen grid current	$I_{g2+g4} =$		3.0	— mA
Conversion conductance	$S_c =$		750	7.5 μA/V
Internal resistance	$R_i =$		>1	>5 MΩ
Equivalent noise resistance	$R_{eq} =$		100	— kΩ

Typical characteristics of the triode section (see Figs. 17 and 18)

Anode voltage	V_a	=	100 V
Grid voltage	V_{gT+g3}	=	0 V
Anode current	I_a	=	10 mA
Mutual conductance	S	=	2.8 mA/V
Amplification factor	μ	=	22

¹⁾ If the grid leak R_{gT+g3} equals 47 kΩ, the recommended value for I_{gT+g3} is 200 μA for supply voltages of 200 and 170 V, and 100 μA for a supply voltage of 100 V.

UCH 42

Operating characteristics of the triode section used as oscillator

(see Figs. 19 to 22 incl.)

Supply voltage . . .	V_b	=	100	170	200	V			
Anode resistor . . .	R_a	=	10	10	22	k Ω			
Oscillator voltage . . .	V_{osc}	=	4	8	8	V_{RMS}			
Oscillator grid leak . . .	R_{gT+g3}	=	22	47	22	47	k Ω		
Oscillator grid current	I_{gT+g3}	=	175	100	350	200	μ A		
Anode current . . .	I_a	=	3.4	3.1	6.5	5.7	5.5	5.2	mA
Effective slope . . .	S_{eff}	=	0.7	0.6	0.75	0.65	0.65	0.55	mA/V

Operating characteristics of the UCH 42 used as phase inverter

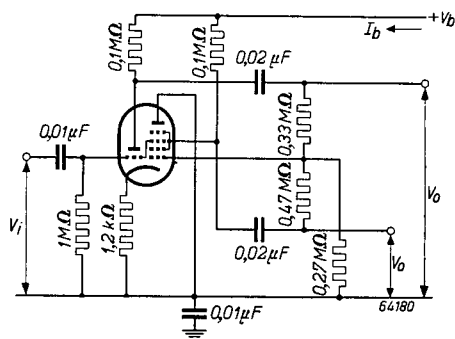

Fig. 4

Supply voltage V_b (V)	Total current I_b (mA)	Amplification V_o/V_i	Distortion (%) at an output voltage of	
			5 V_{RMS}	10 V_{RMS}
100	1.4	11	1.9	—
165	2.4	11	1.5	1.6

Operating characteristics of the hexode section used as frequency changer, together with that of the UAF 42, fed by means of a common potentiometer (see Figs. 23 to 25 incl.)

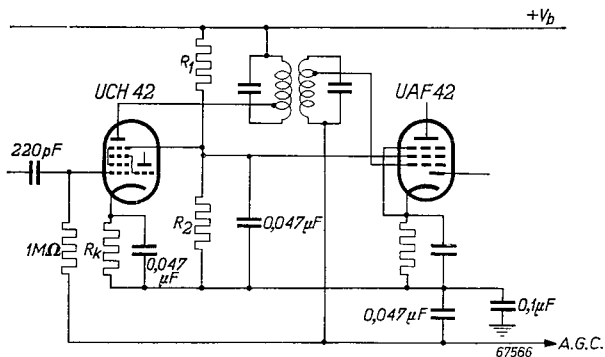

Fig. 5

Anode and supply voltage	$V_a = V_b =$	100	170	V	
Resistor between supply voltage and screen grids	$R_1 =$	15	15	kΩ	
Resistor between screen grids and chassis	$R_2 =$	22	22	kΩ	
Bias resistor	$R_k =$	180	180	Ω	
Oscillator grid leak	$R_{gT+g3} =$	22	22	kΩ	
Oscillator grid current	$I_{gT+g3} =$	175 ¹⁾	350 ¹⁾	μA	
Grid bias	$V_{g1} =$	-1.0 -9.6 -1.8 -15.5 V			
Screen grid voltage	$V_{g2} =$	43	58	70	99 V
Anode current	$I_a =$	1.2	—	2.1	— mA
Screen grid current	$I_{g2+g4} =$	1.46	—	2.6	— mA
Conversion conductance	$S_c =$	530	14	670	20 μA/V
Internal resistance	$R_i =$	>1	>2	>1	>4 MΩ
Equivalent noise resistance	$R_{eq} =$	60	—	66	— kΩ

Limiting values of the hexode section

Anode voltage, cut-off condition	V_{a_o}	= max.	550 V
Anode voltage	V_a	= max.	250 V
Anode dissipation	W_a	= max.	1.5 W
Screen grid voltage, cut-off condition	$V_{(g2+g4)_c}$	= max.	550 V
Screen grid voltage, valve con- trolled	$V_{g2+g4}(I_a < 1\text{mA})$	= max.	250 V
Screen grid voltage, valve un- controlled	$V_{g2+g4}(I_a = 3\text{mA})$	= max.	125 V
Screen grid dissipation	W_{g2+g4}	= max.	0.3 W
Grid current starting point	$V_{g1}(I_{g1} = +0.3\mu\text{A})$	= max.	-1.3 V
Cathode current	I_k	= max.	10 mA
External resistance between grid 1 and cathode	R_{g1}	= max.	3 MΩ ²⁾
External resistance between grid 3 and cathode	R_{g3}	= max.	3 MΩ
External resistance between heater and cathode	R_{fk}	= max.	20 kΩ
Voltage between heater and cathode	V_{jk}	= max.	150 V

¹⁾ See note on page 213.

²⁾ This value is applicable where the grid bias is derived from a cathode resistor.

UCH 42

Limiting values of the triode section

Anode voltage, cut-off condition	V_{a_c}	= max.	550 V
Anode voltage	V_a	= max.	175 V
Anode dissipation	W_a	= max.	0.8 W
Grid current starting point	$V_g(I_g = +0.3\mu\text{A})$	= max.	-1.3 V
Cathode current	I_k	= max.	6 mA
External resistance between grid and cathode	R_g	= max.	3 M Ω
External resistance between heater and cathode	R_{fk}	= max.	20 k Ω
Voltage between heater and cathode	V_{fk}	= max.	150 V

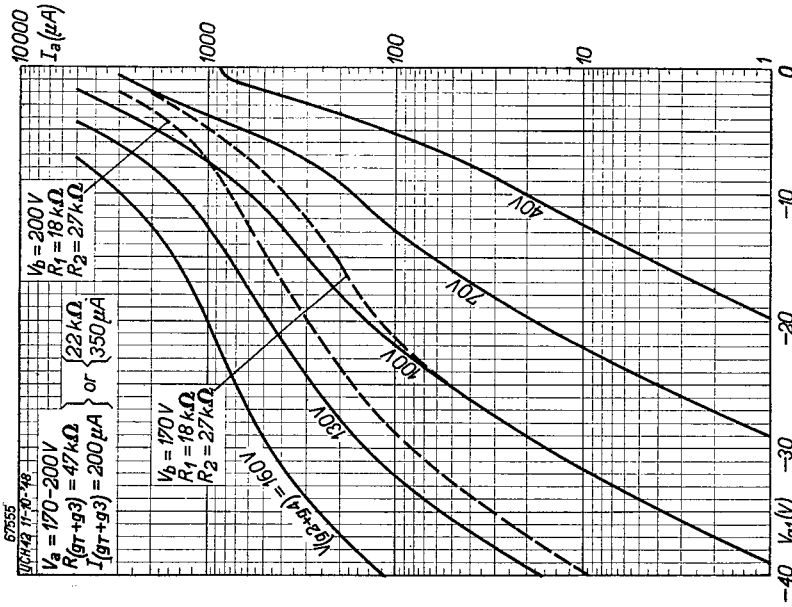

Fig. 7

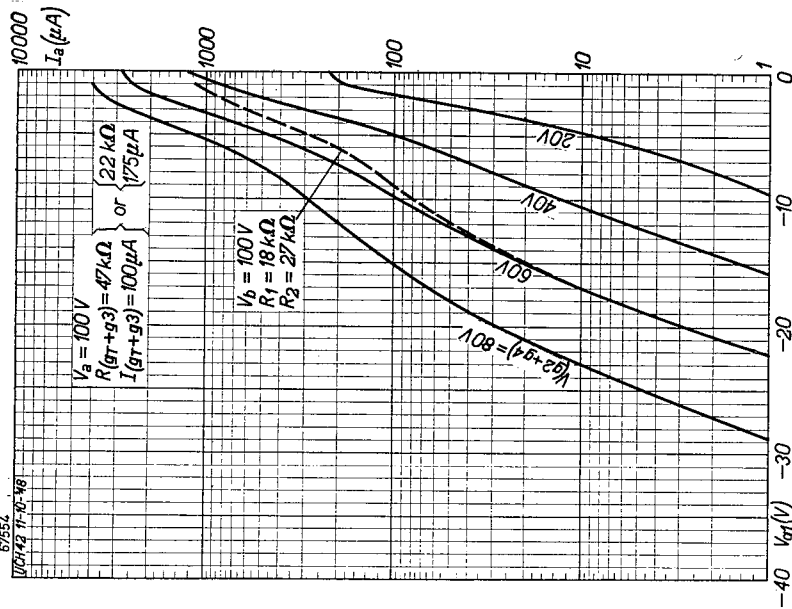

Fig. 6

Anode current (I_a) of the UCH 42 as a function of the grid bias (V_{g1}), measured on oscillating valve, with screen grid voltage (V_{g2+g3}) as parameter. The dotted lines represent the anode current when the screen grids are at 0V. Fig. 6: supply voltage $V_b = 100V$; Fig. 7: $V_b = 170 - 200V$.

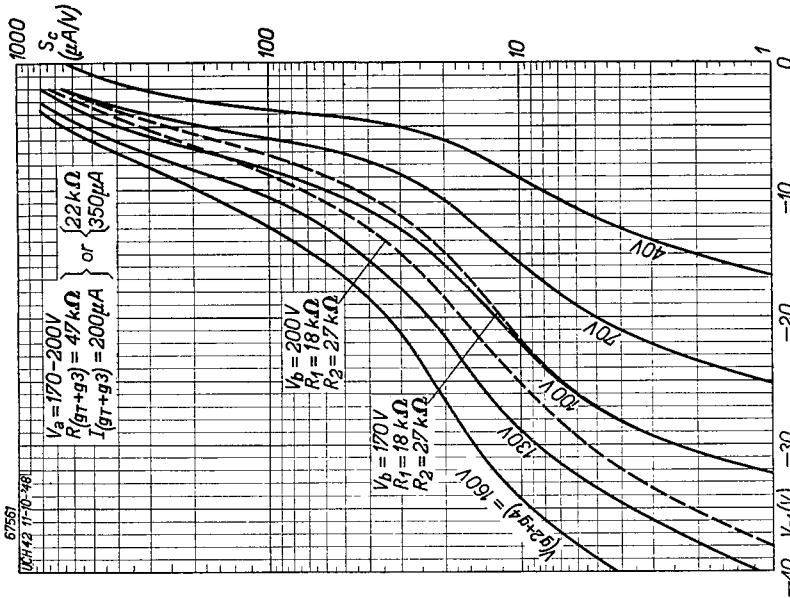

Fig. 9

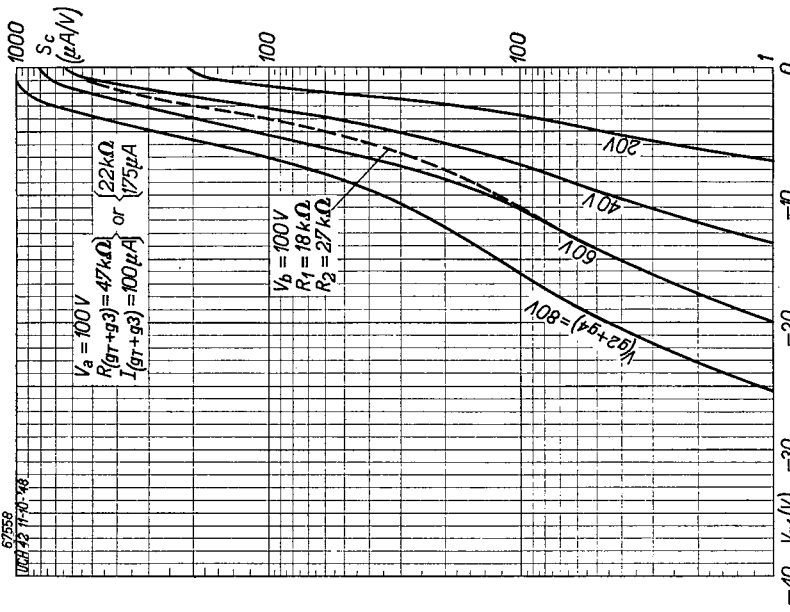

Fig. 8

Conversion conductance (S_c) of UCH 42 in oscillating condition, as a function of the grid bias (V_{g1}) with screen grid voltage (V_{g2+g4}) as parameter. The dotted lines indicate the conversion conductance when the screen grid voltage is derived from a potentiometer (R_1, R_2 in Fig. 3). Fig. 8 : supply voltage $V_b=100$ V ; Fig. 9 : $V_b=170 - 200$ V.

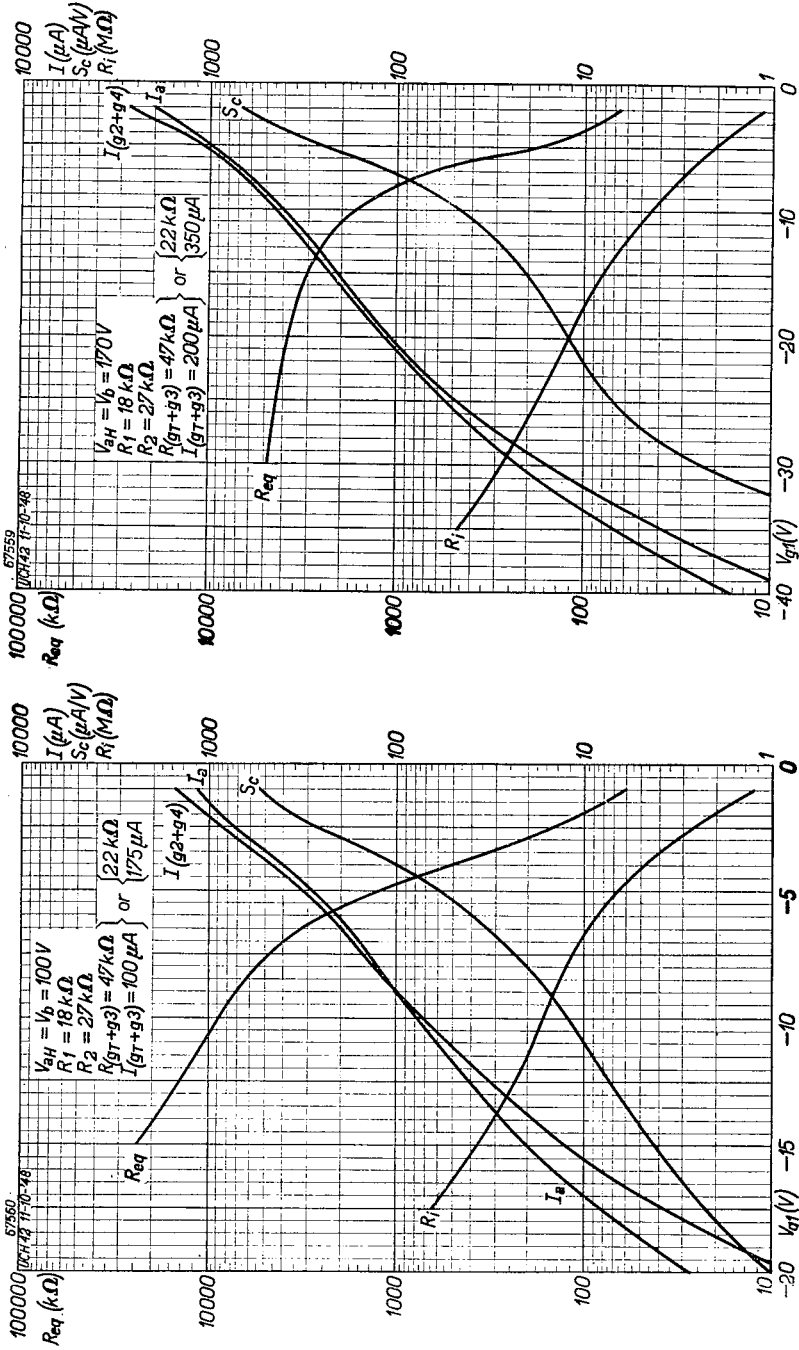

Fig. 10 Anode current (I_a), screen grid current ($I_{g_2+g_4}$), conversion conductance (S_c), internal resistance (R_i) and equivalent noise resistance (R_{eq}) of the UCH 42 in oscillating condition, as functions of the grid bias (V_{g_1}). Measured in the circuit shown in Fig. 3. Fig. 10 : supply voltage $V_b = 100V$. Fig. 11 : $V_b = 170V$.

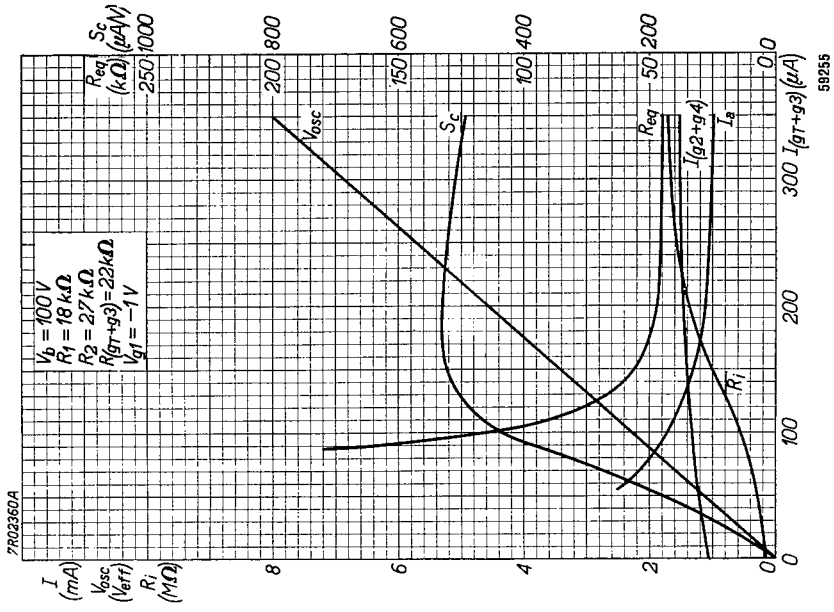

Fig. 12
Anode current (I_a), conversion conductance (S_c), oscillator voltage (V_{osc}), internal resistance (R_i) and equivalent noise resistance (R_{eq}) of the UCH 42 as functions of the oscillator grid current (I_{gT+g3}) for a grid leak R_{gT+g3} of 22 k Ω . Measured in the circuit shown in Fig. 3. Fig. 12 : supply voltage $V_b=100\text{ V}$; Fig. 13 : $V_b=170\text{ V}$.

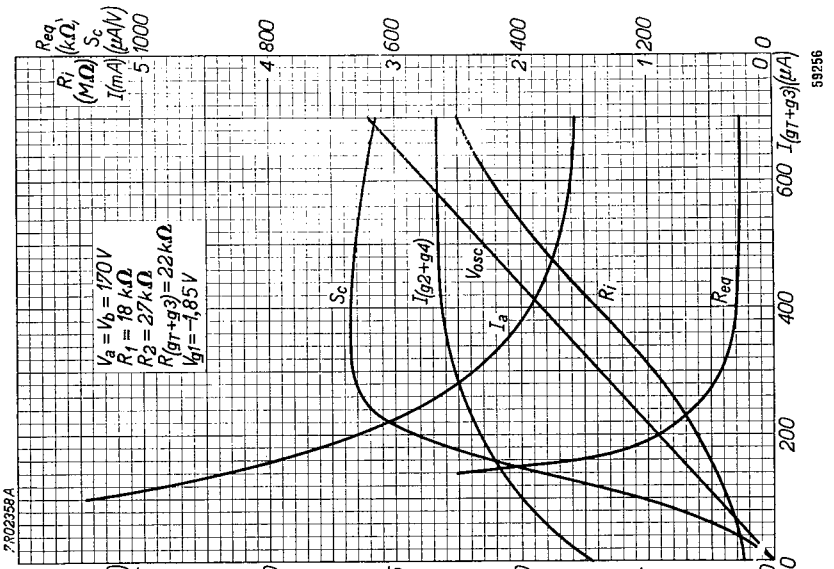

Fig. 13
Anode current (I_a), conversion conductance (S_c), oscillator voltage (V_{osc}), internal resistance (R_i) and equivalent noise resistance (R_{eq}) of the UCH 42 as functions of the oscillator grid current (I_{gT+g3}) for a grid leak R_{gT+g3} of 22 k Ω . Measured in the circuit shown in Fig. 3. Fig. 12 : supply voltage $V_b=100\text{ V}$; Fig. 13 : $V_b=170\text{ V}$.

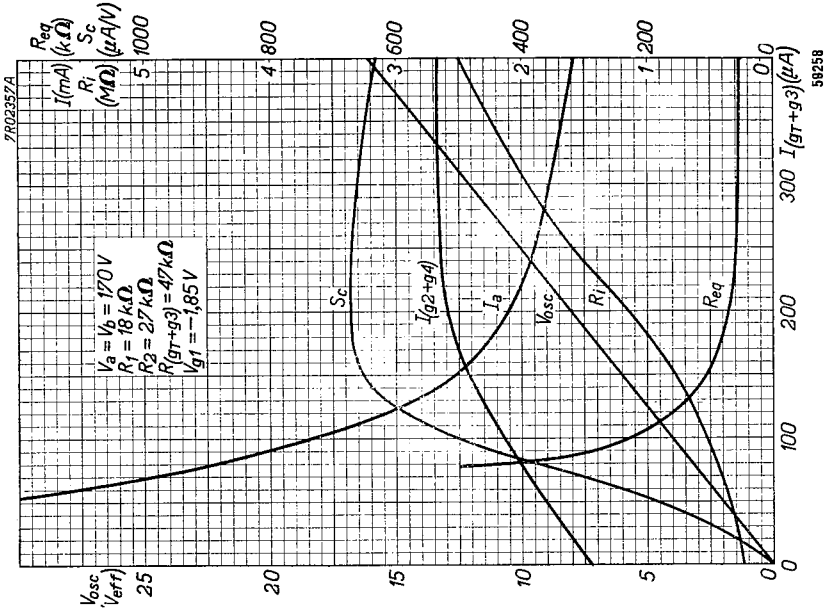

Fig. 15

As Figs. 12 and 13, but for grid leak R_{g1+g3} of 47 k Ω .

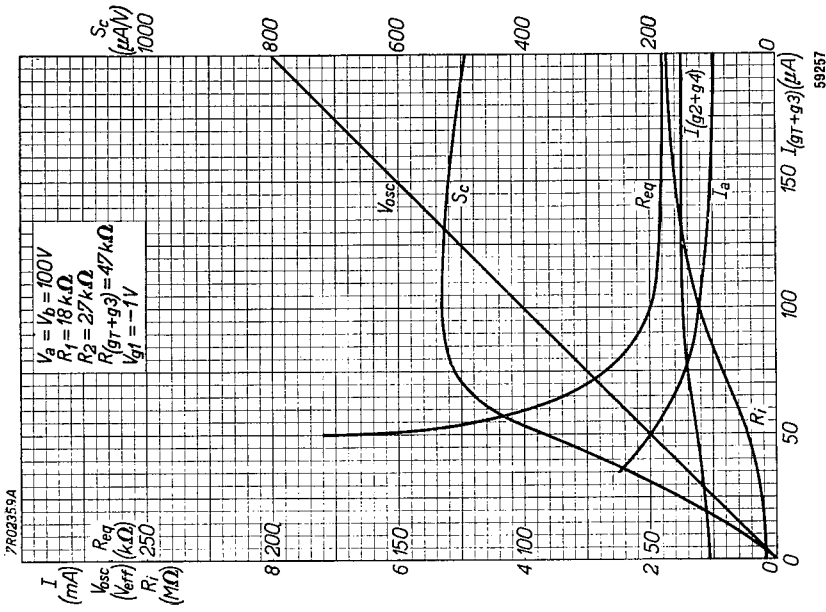

Fig. 14

As Figs. 12 and 13, but for grid leak R_{g1+g3} of 47 k Ω .

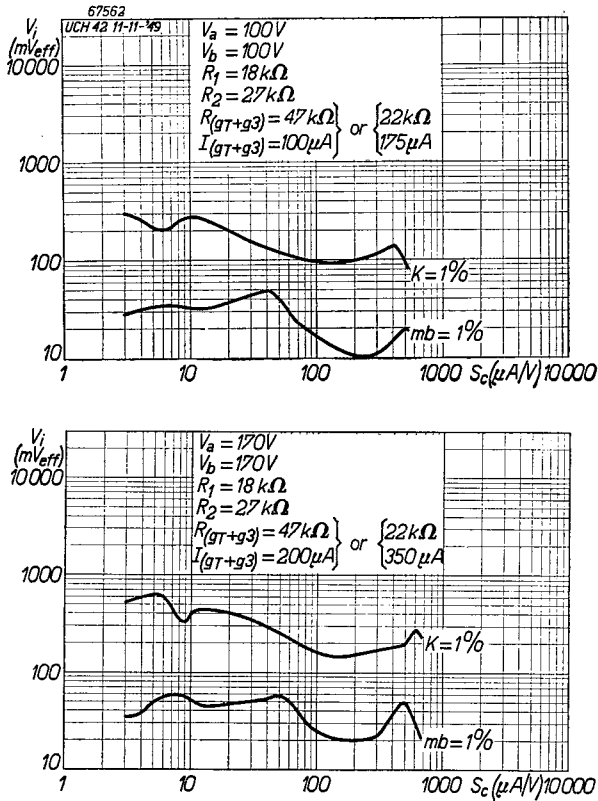

Fig. 16

- 1) The effective voltage (V_i) of an interfering signal at the control grid of the UCH 42 producing 1% cross modulation (curve $K=1\%$) and
- 2) the effective voltage (V_i) of a ripple signal at the control grid producing 1% modulation hum (curve $m_b=1\%$), both as function of the conversion conductance S_c and measured in the circuit shown in Fig. 3. Upper figure: supply voltage $V_b=100V$; lower figure: $V_b=170V$.

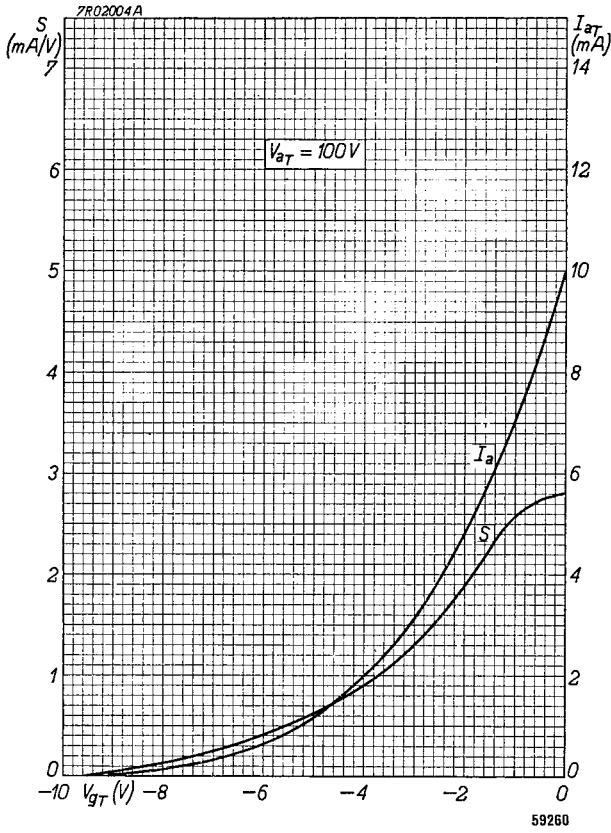
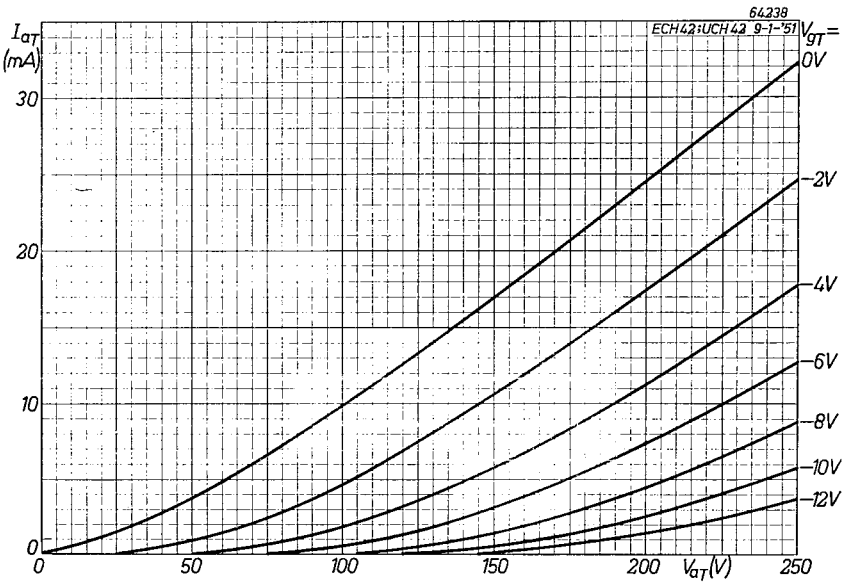

Fig. 17
 I_a/V_g and S/V_g characteristics of the triode section of the UCH 42.

Fig. 18
 I_a/V_a characteristics relative to the triode section of the UCH 42.



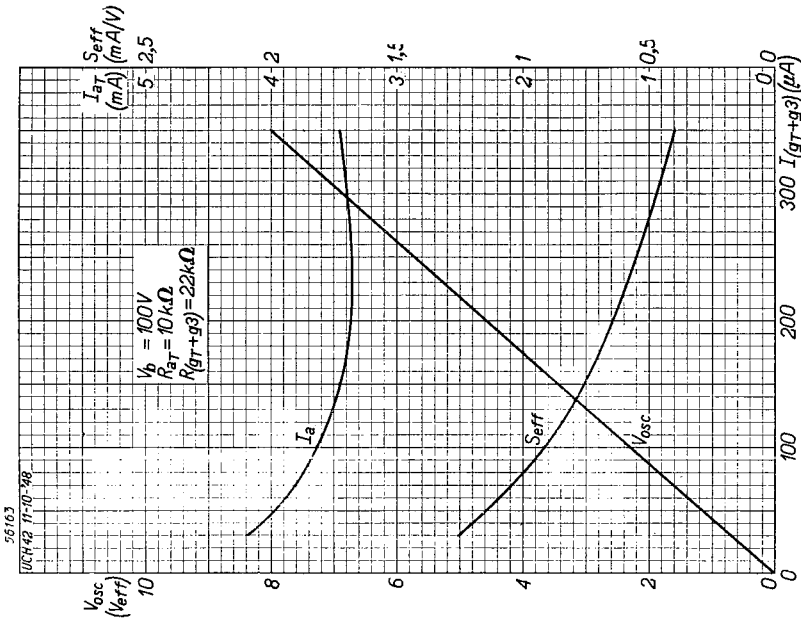

Fig. 19

Anode current (I_a), oscillator voltage (V_{osc}) and effective slope (S_{eff}) of the triode section of the UCH 42 as functions of the oscillator grid current (I_{gr+gs}), with grid leak (R_{gr+gs}) of 22 k Ω . Fig. 19: supply voltage $V_b=100$ V; Fig. 20: $V_b=170$ V.

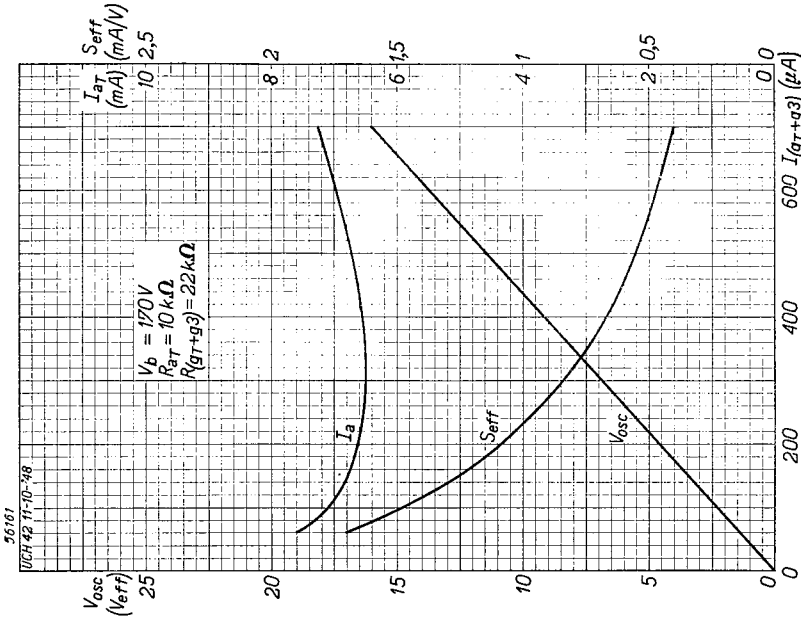

Fig. 20

Anode current (I_a), oscillator voltage (V_{osc}) and effective slope (S_{eff}) of the triode section of the UCH 42 as functions of the oscillator grid current (I_{gr+gs}), with grid leak (R_{gr+gs}) of 22 k Ω . Fig. 19: supply voltage $V_b=100$ V; Fig. 20: $V_b=170$ V.

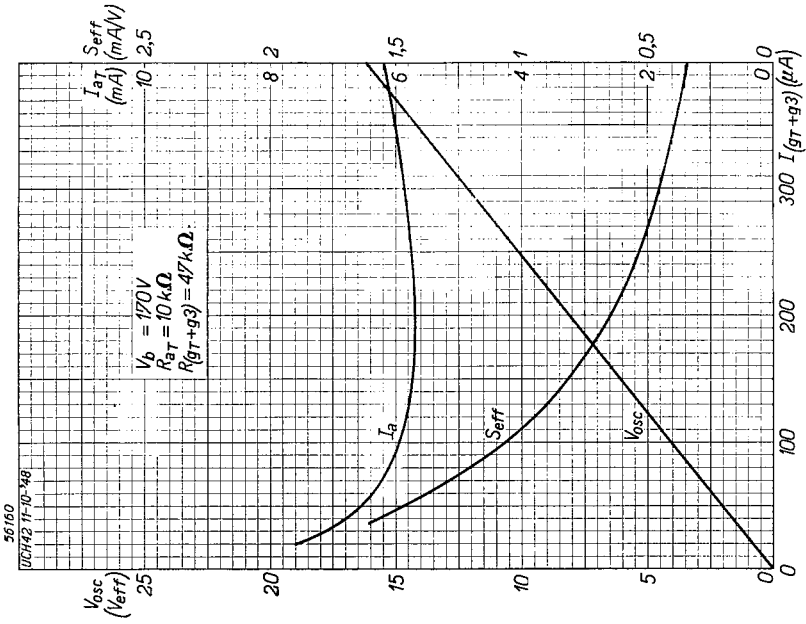

Fig. 22

As Figs. 19 and 20, but with a grid leak $R_{(gr+gs)}$ of 47 kΩ.

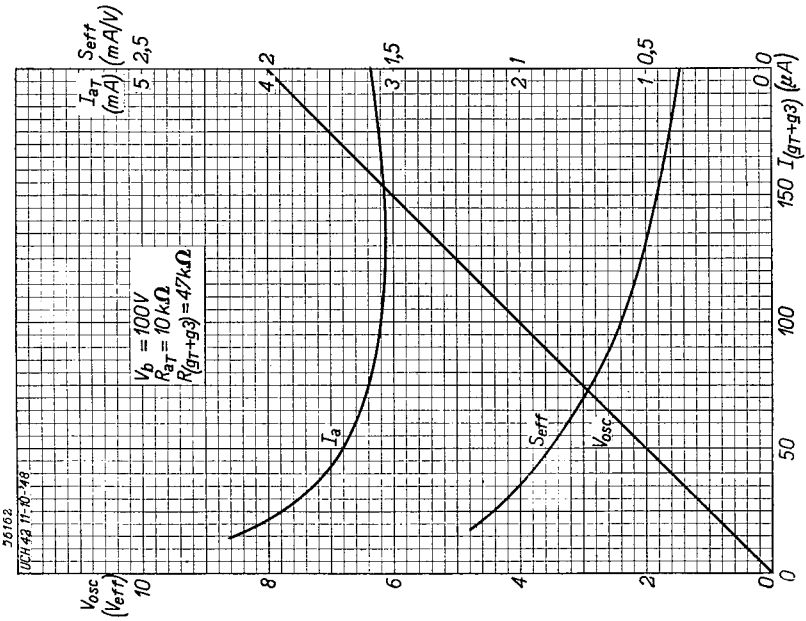

Fig. 21

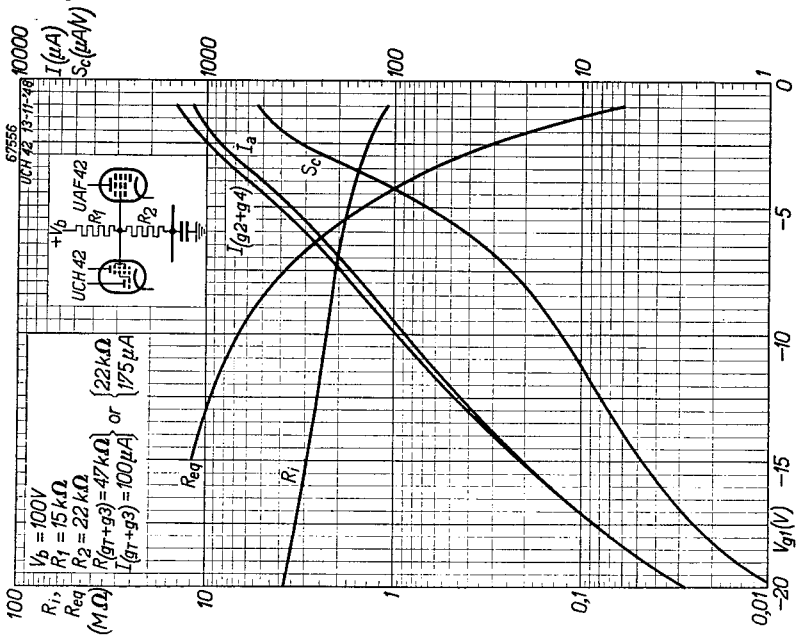
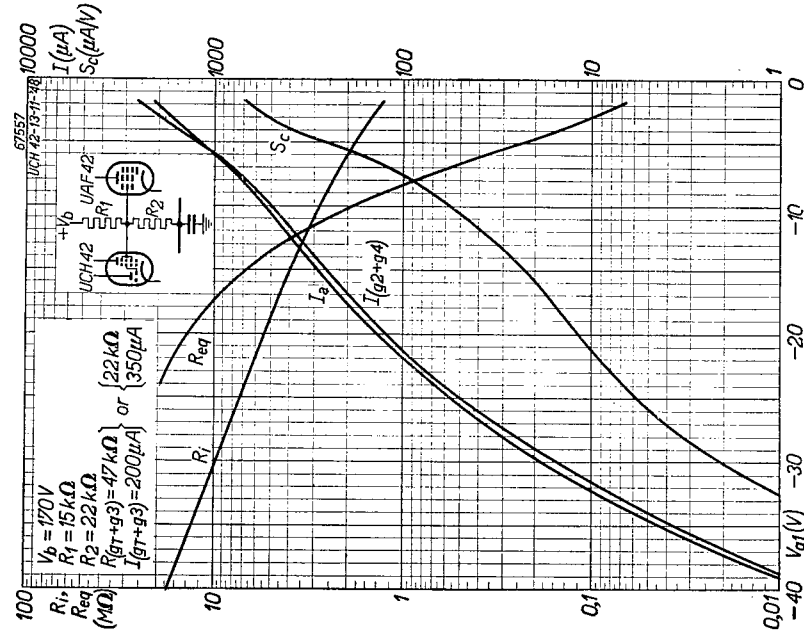

Fig. 23

As Figs. 10 and 11, but with the screen grid voltage of the UCH 42 together with that of the UAF 42 fed by means of a common potentiometer. Measured in the circuit shown in Fig. 5. Fig. 23 : supply voltage $V_b = 100 V$; Fig. 24 : $V_b = 170 V$.

Fig. 24



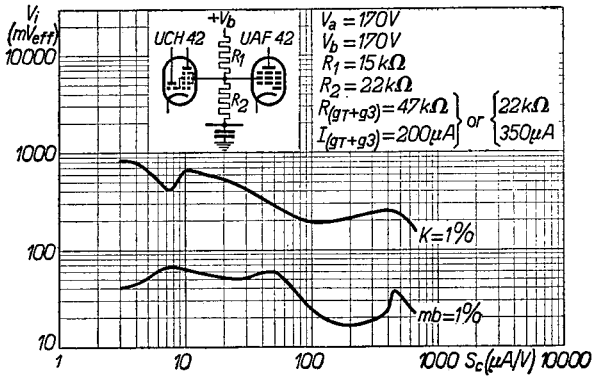
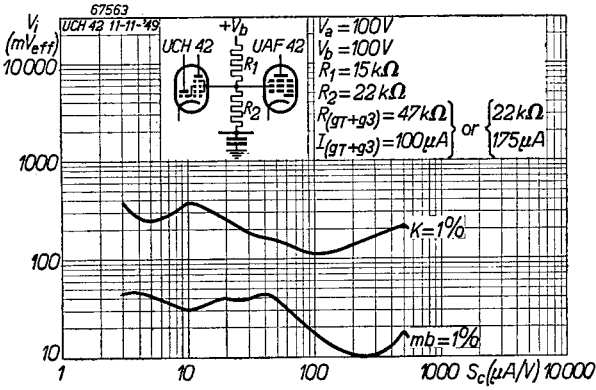

Fig. 25

As Fig. 16, but with the screen grids of the UAF 42 and UCH 42 fed by means of a common potentiometer.

UF 41

UF 41 Variable-mu R.F. pentode

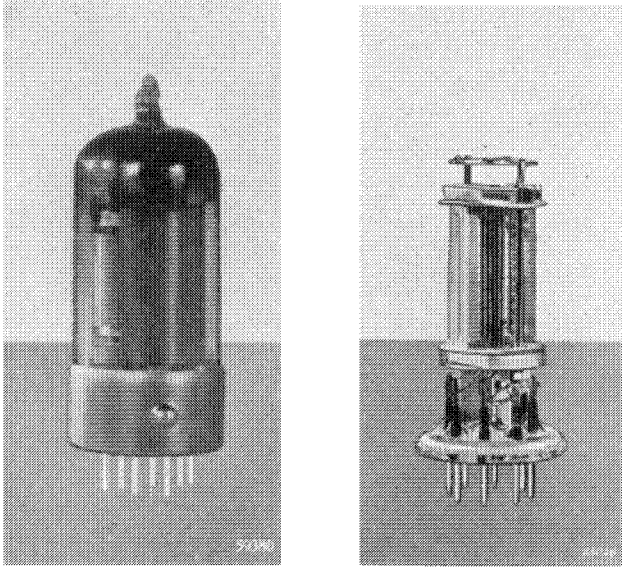

Fig. 1

The UF 41, showing the electrode system (approximately actual size).

The UF 41 is a variable- μ pentode employing sliding screen grid voltage. It is intended for I.F. and R.F. amplification. At the working point, the mutual conductance is 2.2 mA/V at an applied voltage of 170 V, or 1.9 mA/V at 100 V. Since the heater current of the valve is 100 mA, the heater can be connected in series with the heaters of other U-type Rimlock valves. As the characteristics of the UF 41 are wholly identical with those of the EF 41, reference may be made to the description of the latter for further particulars.

TECHNICAL DATA OF THE R.F. PENTODE UF 41

Heater data

Heating : indirect, A.C. or D.C., series feed

Heater current	I_f	=	100 mA
Heater voltage	V_f	=	12.6 V

Capacitances (cold valve)

Input capacitance	C_{g1}	=	5.3 pF
Output capacitance	C_a	=	5.9 pF
Anode - control grid	C_{ag1}	<	0.002 pF
Heater - control grid	C_{hf}	<	0.05 pF

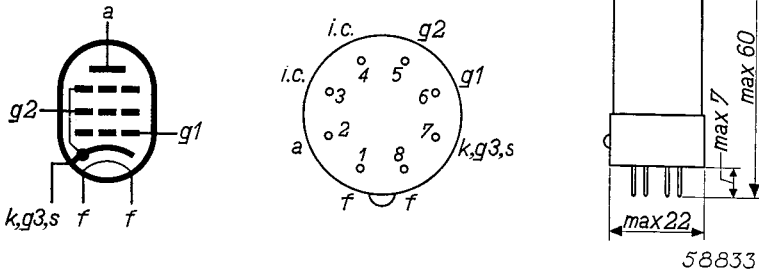

Fig. 2

Electrode arrangement, electrode connections and maximum dimensions in mm of the UF 41.

Operating characteristics of the UF 41 used as R.F. or I.F. amplifier
(see Figs. 6 and 7)

A. With fixed screen grid voltage

Anode voltage	V_a	=	100	V
Screen grid voltage	V_{g2}	=	100	V
Bias resistor	R_k	=	325	Ω
Grid bias	V_{g1}	=	$\overbrace{-2.5 \text{ --- } -16.5}$	V
Anode current	I_a	=	6.0	— mA
Screen grid current	I_{g2}	=	1.75	— mA
Mutual conductance	S	=	2200	22 $\mu\text{A/V}$
Internal resistance	R_i	=	0.6	>10 M Ω
Equivalent noise resistance	R_{eq}	=	6.5	— k Ω
Amplification factor, grid 2 with respect to grid 1	μ_{g2g1}	=	18	—

B. With sliding screen grid voltage

Anode and supply voltage	$V_a = V_b =$	100	170	V
Screen grid series resistor	R_{g2}	=	40	k Ω
Bias resistor	R_k	=	325	325 Ω
Grid bias	V_{g1}	=	$\overbrace{-1.4 \text{ --- } -17}$	$\overbrace{-2.5 \text{ --- } -28}$ V
Anode current	I_a	=	3.3	— 6.0 mA
Screen grid current	I_{g2}	=	1.0	— 1.7 mA
Mutual conductance	S	=	1900	19 2200 22 $\mu\text{A/V}$
Internal resistance	R_i	=	0.8	>10 1.0 >10 M Ω
Equivalent noise resistance	R_{eq}	=	5.5	— 6.5 k Ω
Amplification factor, grid 2 with respect to grid 1	μ_{g2g1}	=	18	— 18

UF 41

Anode and supply voltage . . .	$V_a = V_b$	=	200	V
Screen grid series resistor . . .	R_{g2}	=	40	k Ω
Bias resistor	R_k	=	325	Ω
Grid bias	V_{g1}	=	$\overbrace{-3 \quad -34}$	V
Anode current	I_a	=	7.2	— mA
Screen grid current	I_{g2}	=	2.1	— mA
Mutual conductance	S	=	2300	23 μ A/V
Internal resistance	R_i	=	1.0	>10 M Ω
Equivalent noise resistance . . .	R_{eq}	=	7.0	— k Ω
Amplification factor, grid 2 with respect to grid 1	μ_{g2g1}	=	18	—

Operating characteristics of the UF 41 used as R.F. or I.F. amplifier, with screen grid, together with that of frequency changer UCH 41 fed by means of a common potentiometer

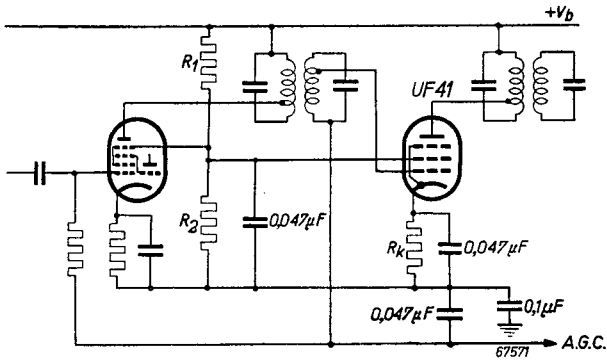

Fig. 3

Anode and supply voltage . . .	$V_a = V_b =$	100	170	V			
Potentiometer for screen grid supply	$\left\{ \begin{array}{l} R_1 \\ R_2 \end{array} \right.$	=	12	27	k Ω		
Bias resistor		R_k	=	235	235	Ω	
Grid bias	V_{g1}	=	$\overbrace{-1.0 \quad -12}$	$\overbrace{-1.8 \quad -20}$	V		
Screen grid voltage	V_{g2}	=	53	69	87	117	V
Anode current	I_a	=	3.3	—	6.0	—	mA
Screen grid current	I_{g2}	=	1.0	—	1.75	—	mA
Mutual conductance	S	=	1900	19	2200	22	μ A/V
Internal resistance	R_i	=	0.8	>10	1.0	>10	M Ω
Equivalent noise resistance . . .	R_{eq}	=	5.5	—	6.5	—	k Ω
Amplification factor, grid 2 with respect to grid 1	μ_{g2g1}	=	18	—	18	—	

Limiting values

Anode voltage, with valve biased to cut-off	V_{a_0}	= max.	550 V
Anode voltage	V_a	= max.	250 V
Anode dissipation	W_a	= max.	2 W
Screen grid voltage, valve biased to cut-off	V_{g2_0}	= max.	550 V
Screen grid voltage, valve controlled	$V_{g2}(I_a < 4\text{mA})$	= max.	250 V
Screen grid voltage, valve uncontrolled	$V_{g2}(I_a = 7.2\text{mA})$	= max.	150 V
Screen grid dissipation	W_{g2}	= max.	0.3 W
Cathode current	I_k	= max.	10 mA
Grid current starting point	$V_{g1}(I_{g1} = +0.3\mu\text{A})$	= max.	-1.3 V
External resistance between grid 1 and cathode	R_{g1}	- max.	3 MΩ ¹⁾
External resistance between heater and cathode	R_{fk}	= max.	20 kΩ
Voltage between heater and cathode	V_{fk}	= max.	150 V

¹⁾ This value is applicable where grid bias is obtained from a cathode resistor.

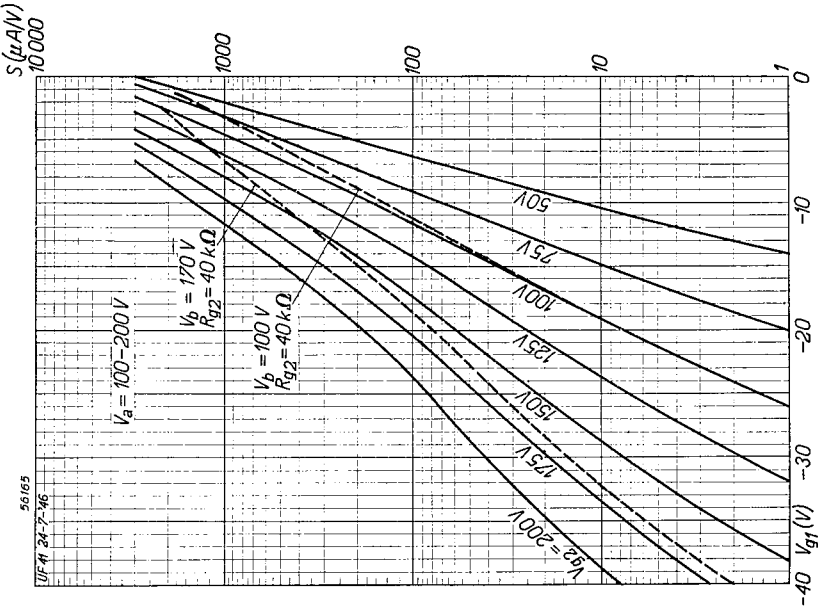

Fig. 5

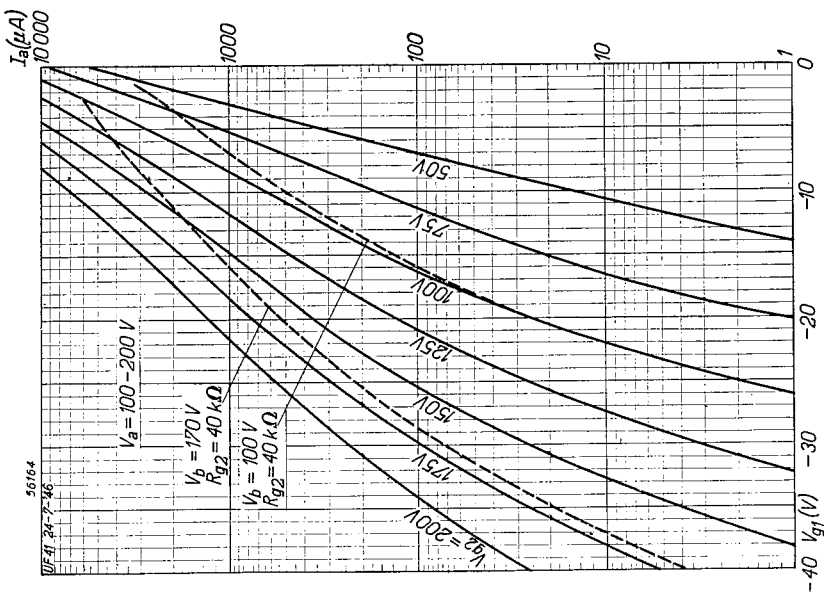

Fig. 4

Anode current (I_a , Fig. 4) and mutual conductance (S , Fig. 5) of the UF 41 as functions of the grid bias (V_{g1}) for various screen grid voltages (V_{g2}). The dotted lines represent the anode current and mutual conductance with a series resistor (R_{g2}) of 40 kΩ in the screen grid circuit, at supply voltages of 100 V and 170 V.

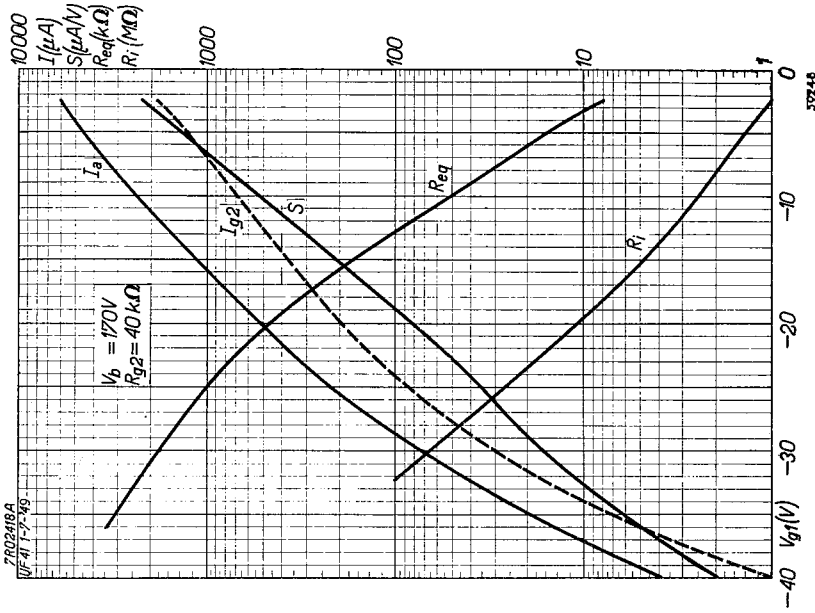

Fig. 7

Anode current (I_a), screen grid current (I_{sg}), mutual conductance (S), internal resistance (R_i) and equivalent noise resistor ($R_{sg} = 40\text{ k}\Omega$, supply voltage $V_b = 100\text{ V}$ (Fig. 6) and 170 V (Fig. 7).

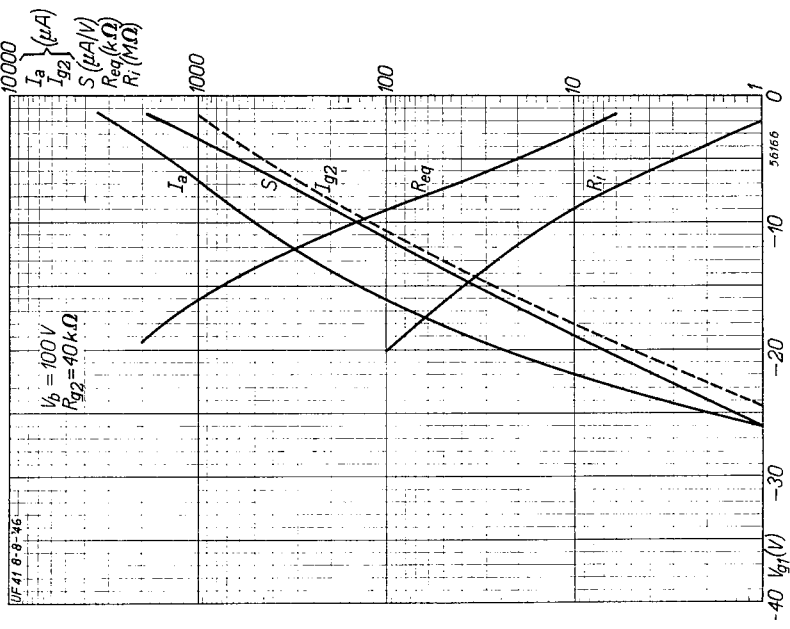

Fig. 6

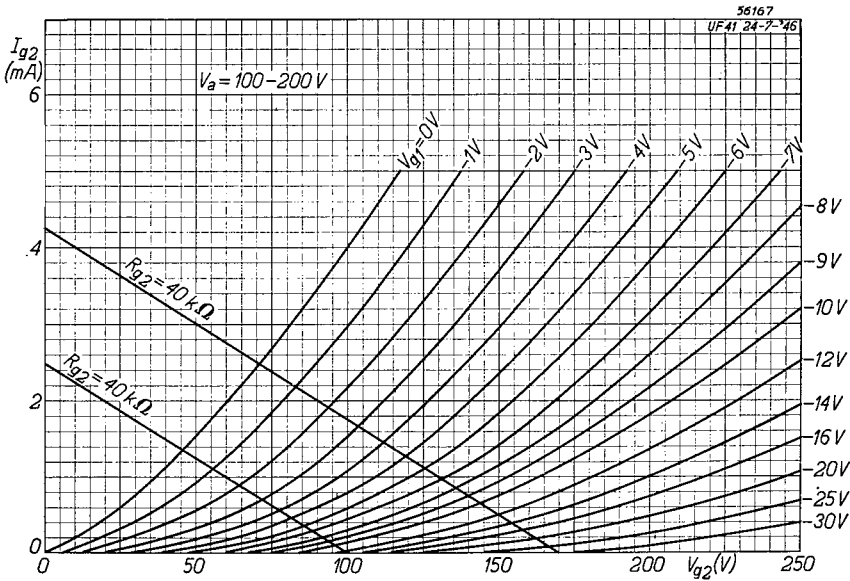

Fig. 8

Screen grid current (I_{g2}) of the UF 41 as a function of the screen grid voltage (V_{g2}) with grid bias (V_{g1}) as parameter. The straight lines are applicable with $40\text{ k}\Omega$ series resistor in the screen grid circuit, with a supply voltage of 100 and 170 V.

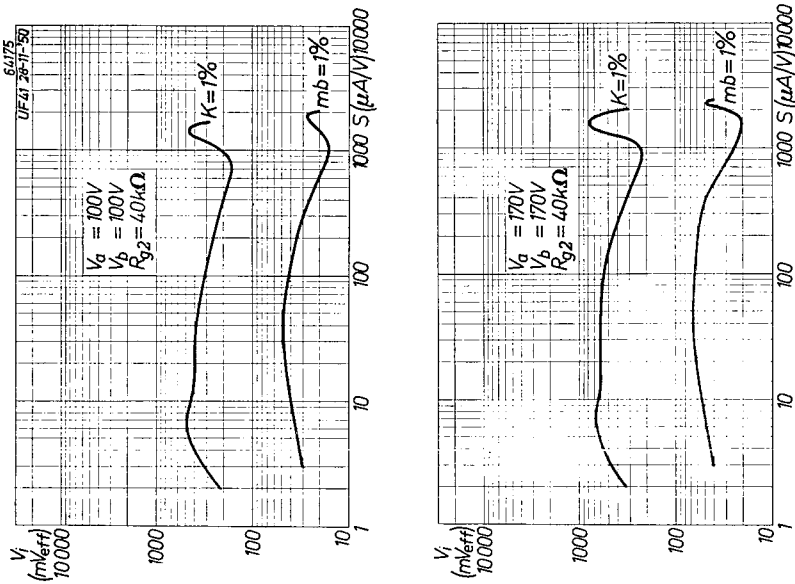

Fig. 9

The effective voltage (V_i) of an interfering signal at the control grid of the UF 41, producing 1% cross-modulation (curve $K=1\%$); also the effective voltage (V_i) of a ripple signal at the control grid, causing 1% modulation hum (curve $mb=1\%$). Both as function of the slope S .

UL 41 9 W output pentode

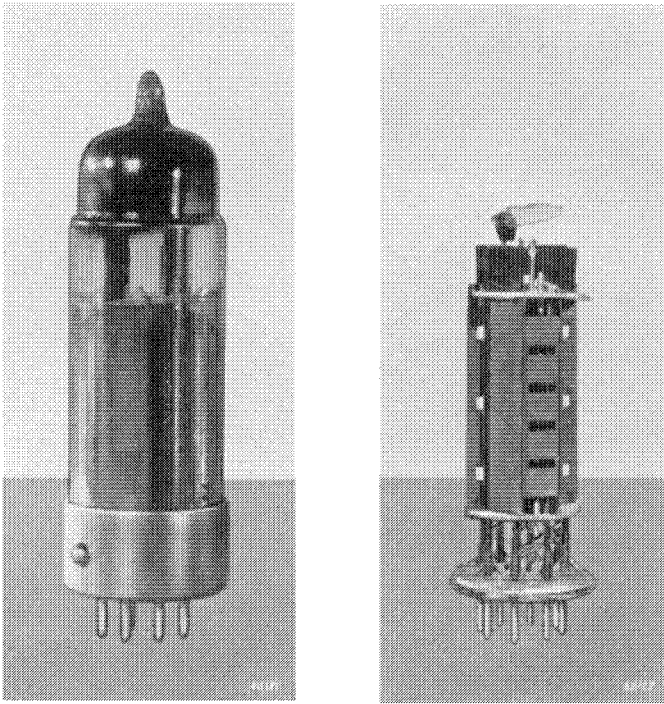

Fig. 1. The UL 41, showing the electrode system (approximately actual size).

The UL 41 is an output pentode with a high mutual conductance and a maximum permissible anode dissipation of 9 W. It is designed for use in A.C./D.C. receivers for a nominal voltage range of 110—250 V. Despite the fact that such a supply voltage range implies large variations in the actual voltage applied to the valve, the circuit of the output valve needs no alteration. A bias resistor of 165 ohms is suitable for all voltages; no extra resistor is needed in the screen grid circuit for the higher voltages, and the optimum load is always roughly 3000 ohms.

The mutual conductance of this valve is 9.5 mA/V at 170 V, or 8 mA/V at 100 V (anode and screen grid voltage). At 170 V, which is obtained from a line voltage of 220 V, the maximum output is 4.7 W, whilst at 100 V (line voltage approx. 110 V) the output is 1.25 W.

The high mutual conductance of the valve has two advantages. Firstly, only a small input signal is required to modulate the valve fully; for example, at $V_a = V_{g2} = 100$ V the required input is 3.8 V_{RMS} , or at $V_a = V_{g2} = 170$ V the input is 7.2 V_{RMS} . This is particularly important in small receivers having no A.F. pre-amplifier, but a highly sensitive output valve is also

UL 41

an advantage in larger sets because the reserve of gain can be used for feedback, to reduce distortion. Secondly, the grid bias is very low. Since the total available D.C. voltage is divided between grid bias and anode voltage, more voltage is available for the anode and screen grid, this being highly important when the receiver is to be operated on low voltage mains. If two UL 41 valves are used in class AB push-pull, with automatic grid bias, the output is 9 W with 5% distortion at an applied voltage of 170 V, or 2.2 W with 4% distortion at 100 V.

As already mentioned, the maximum permissible anode dissipation of the UL 41 is 9 W. The full implications of this statement will be found in the description of the EL 41

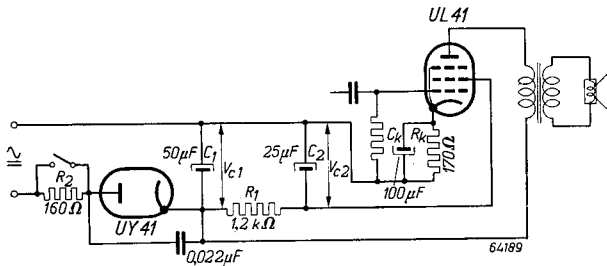

Fig. 2. The UL 41 used in a simple A.C./D.C. receiver; the illustration also shows the appropriate power supply circuit.

Fig. 2 shows the UL 41 used in a simple A.C./D.C. receiver circuit with the appropriate rectifier section. The smoothing filter consists of capacitors C_1 and C_2 and a resistor of 1200 ohms. If the anode voltage of the UL 41 were taken from the fully smoothed side of this filter, an excessive voltage drop would take place across the resistor, for which reason the anode feed is taken from C_1 . In actual practice this circuit has proved to be very satisfactory and, in most cases, is sufficiently free from hum. If necessary, a hum-bucking winding can be included in the speaker transformer.

In order to avoid parasitic oscillation, it is advisable to keep the screen and control grid leads as short as possible; under adverse conditions, a 1 kΩ resistor may be included in the control grid circuit and/or a 100 Ω resistor in the screen grid line. These resistors should be connected as closely as possible to the valve, without decoupling.

TECHNICAL DATA OF THE OUTPUT PENTODE UL 41

Heater data

Heating: indirect, A.C. or D.C., series feed

Heater current	I_f	=	100 mA
Heater voltage	V_f	=	45 V

Capacitances (cold valve)

Input capacitance	C_{g1}	=	11 pF
Output capacitance	C_a	=	8.3 pF
Anode - control grid	C_{ag1}	<	1 pF
Heater - control grid	C_{g1f}	<	0.1 pF

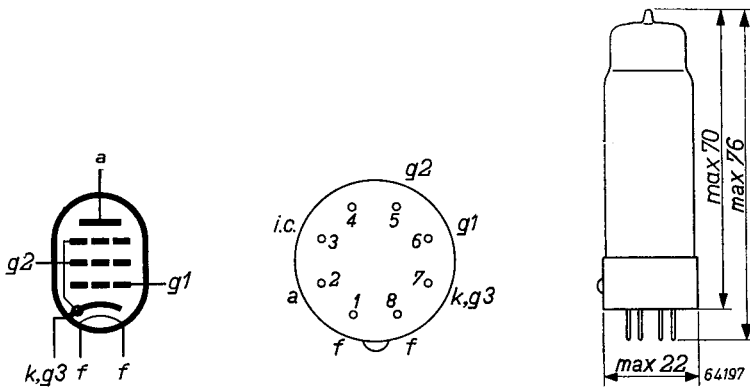

Fig. 3

Electrode arrangement, electrode connections and maximum dimensions in mm.

Operating characteristics as single valve in Class A circuit

Anode voltage	V_a	=	100	170 V
Screen grid voltage	V_{g2}	=	100	170 V
Grid bias	V_{g1}	=	-5.7	-10.4 V
Anode current	I_a	=	29	53 mA
Screen grid current	I_{g2}	=	5.5	10 mA
Mutual conductance	S	=	8.0	9.5 mA/V
Amplification factor, grid 2 with respect to grid 1				
	μ_{g2g1}	=	10	10
Internal resistance	R_i	=	18	20 k Ω
Optimum load	R_a	=	3	3 k Ω
Output with 10% distortion	$W_0(d=10\%)$	=	1.25	4.0 W
Required A.C. input voltage at 10% distortion	$V_i(d=10\%)$	=	3.8	6.0 V _{RMS}
Output at grid current starting point	$\left\{ \begin{array}{l} W_0 \\ (I_{g1} = +0.3\mu A) \end{array} \right.$	=	1.25	4.7 W
Sensitivity	$\left\{ \begin{array}{l} V_i \\ (W_0 = 50mW) \end{array} \right.$	=	0.55	0.5 V _{RMS}

UL 41

Operating characteristics of two valves in Class AB push-pull

Anode voltage	V_a	=	100	V
Screen grid voltage	V_{g2}	=	100	V
Common bias resistor	R_k	=	100	Ω
Optimum load	R_{aa}	=	4.0	k Ω
A.C. input voltage	V_i	=	0	4.6 V_{RMS}
Anode current	I_a	=	2×25	2×27 mA
Screen grid current	I_{g2}	=	2×5	2×6.8 mA
Output power	W_o	=	0	2.2 W
Distortion	d_{tot}	=	—	4 %
Anode voltage	V_a	=	170	V
Screen grid voltage	V_{g2}	=	170	V
Common bias resistor	R_k	=	100	Ω
Optimum load	R_{aa}	=	4.0	k Ω
A.C. input voltage	V_i	=	0	9.3 V_{RMS}
Anode current	I_a	=	2×46	2×49 mA
Screen grid current	I_{g2}	=	2×9	2×16.5 mA
Output power	W_o	=	0	9.0 W
Distortion	d_{tot}	=	—	5 %

Limiting values

Anode voltage, valve biased to cut-off	V_{a_o}	= max.	550 V
Anode voltage	V_a	= max.	250 V
Anode dissipation	W_a	= max.	9 W
Screen grid voltage, valve biased to cut-off	V_{g2_o}	= max.	550 V
Screen grid voltage	V_{g2}	= max.	250 V
Screen grid dissipation, no input signal	$W_{g2}(V_i=0)$	= max.	1.75 W
Screen grid dissipation, at max. output	$W_{g2}(W_o=\max)$	= max.	4.0 W
Cathode current	I_k	= max.	75 mA
Grid current starting point	$V_{g1}(I_{g1}=+0.3\mu A)$	= max.	-1.3 V
External resistance between control grid and cathode (with bias resistor)	$R_{g1}(R_k=165\Omega)$	= max.	1 M Ω
External resistance between heater and cathode	R_{fk}	= max.	20 k Ω
Voltage between heater and cathode	V_{fk}	= max.	150 V

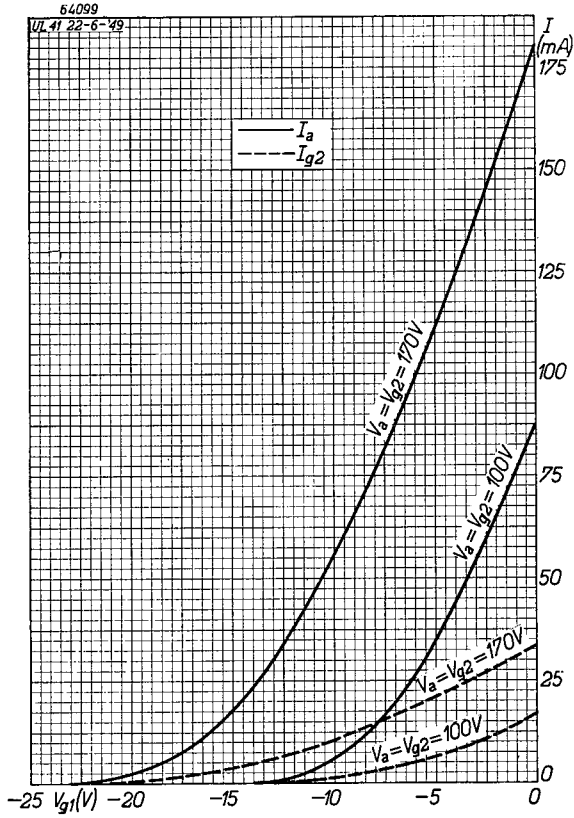

Fig. 4
Anode current (I_a) and screen grid current (I_{g2}) of the UL 41
at anode and screen grid voltages of 100 V and 170 V.

UL 41

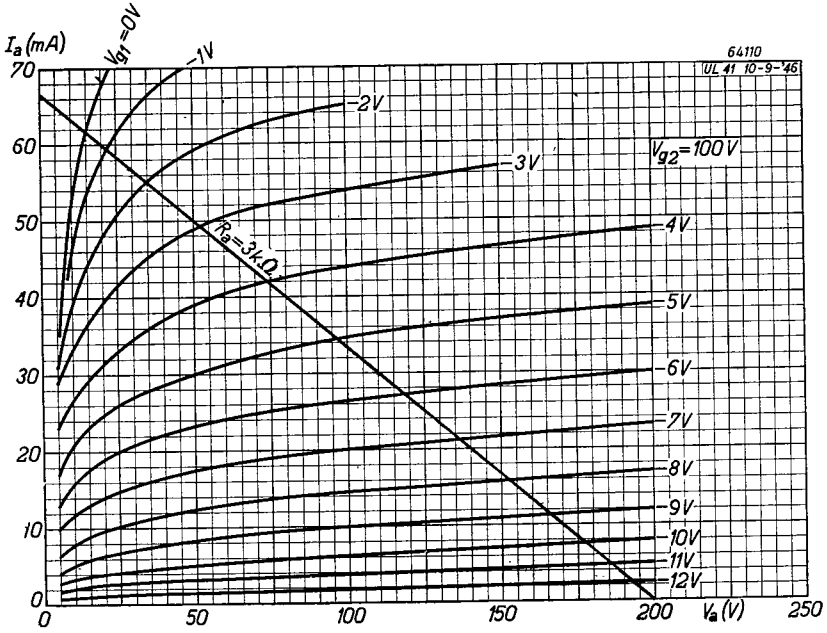

Fig. 5

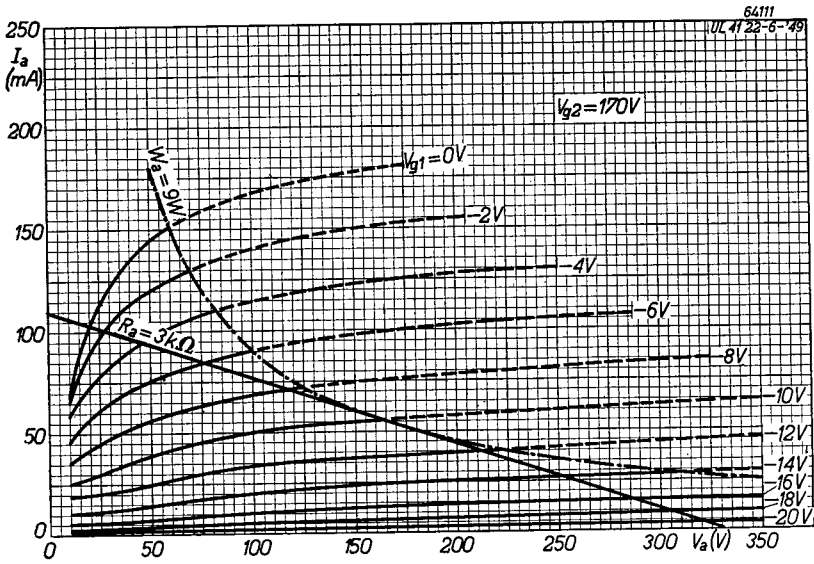

Fig. 6

I_a/V_a characteristics at $V_{g2} = 100$ V (Fig. 5) and 170 V (Fig. 6). The straight line represents a load resistance of 3 k Ω . The dot-dash curve in Fig. 6 indicates the maximum permissible anode dissipation ($P_a = 9$ W).

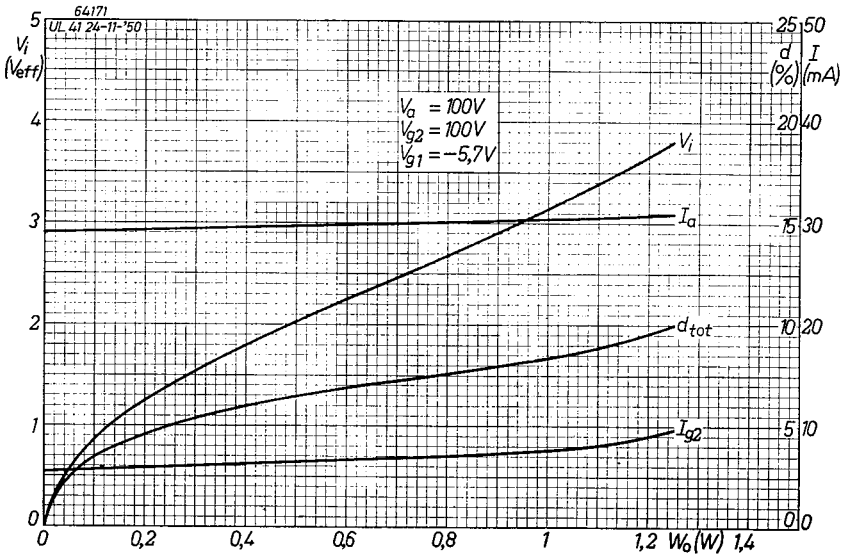

Fig. 7

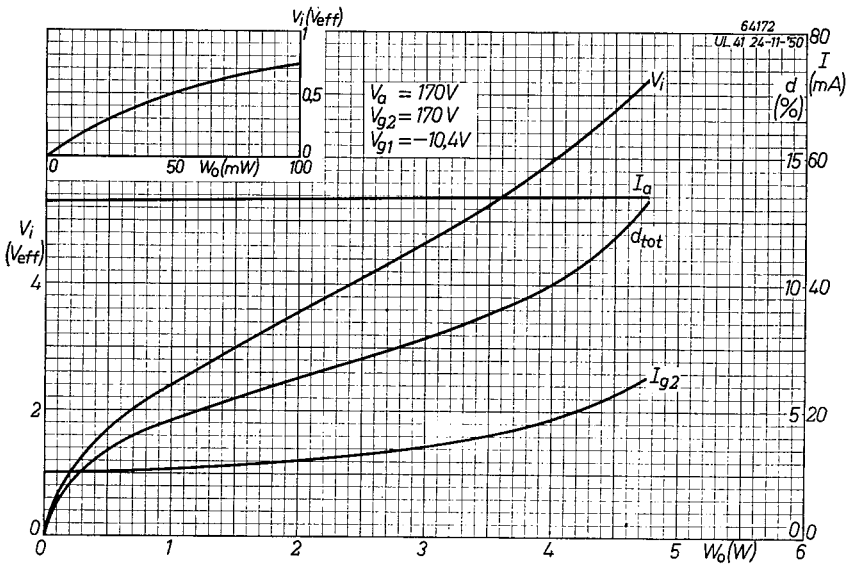

Fig. 8

Anode current (I_a), screen grid current (I_{g2}), A.C. input voltage (V_i) and distortion (d_{tot}) as functions of the output power (W_o). Fig. 7: anode and screen grid voltages=100 V. Fig. 8: anode and screen grid voltages=170 V. The curve in the inset is the lower end of the V_i -curve.

UL 41

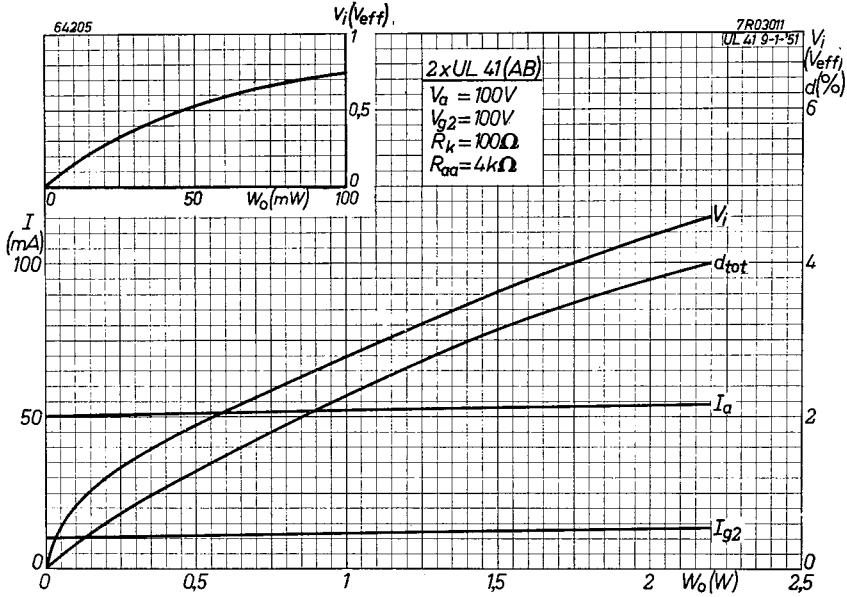

Fig. 9

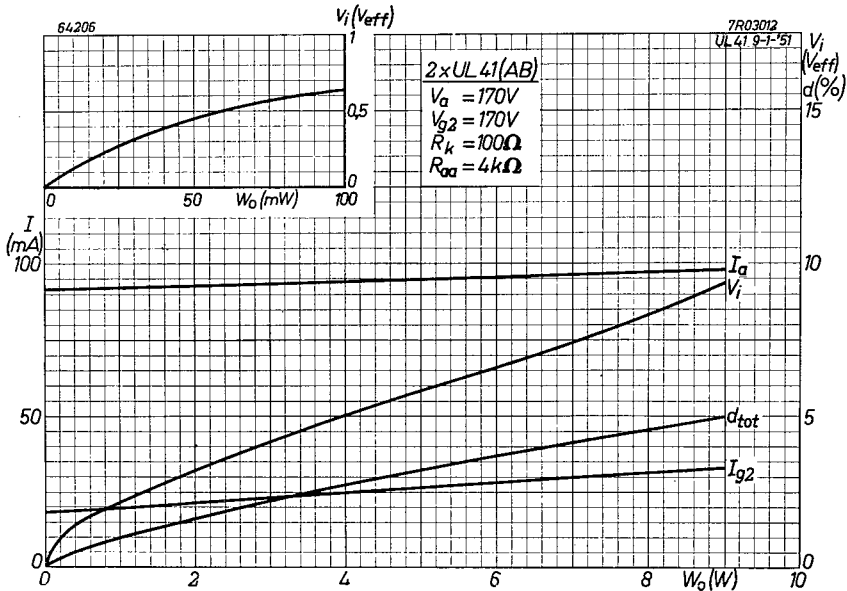

Fig. 10

Anode current (I_a), screen grid current (I_{g2}), A.C. input voltage (V_i) and distortion (d_{tot}) as functions of the output (W_o) for two valves UL 41 in Class AB push-pull. Fig. 9 : anode and screen grid voltages = 100 V; Fig. 10: anode and screen grid voltages = 170 V. The curves in the insets are the lower ends of the V_i -curves.

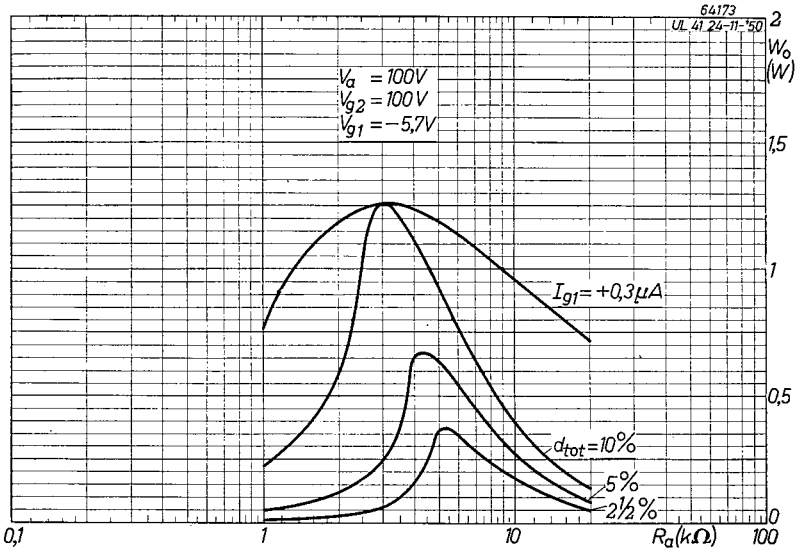

Fig. 11

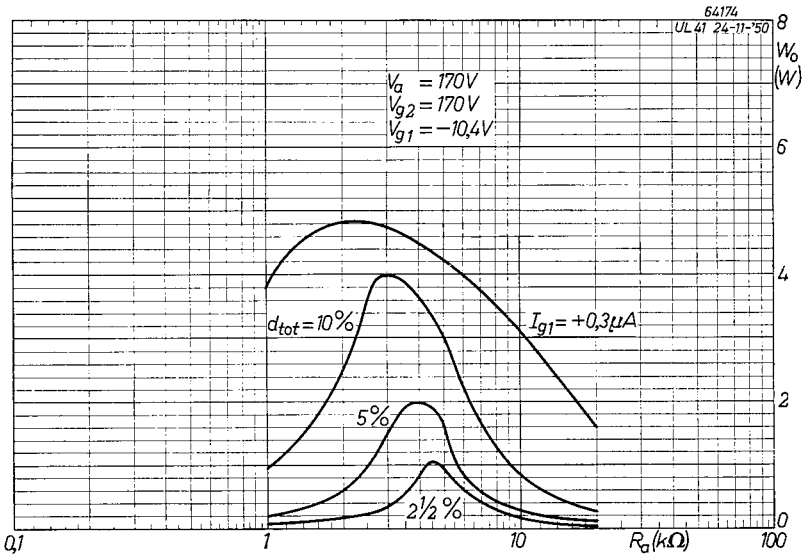

Fig. 12

The output (W_0) with 2.5, 5 and 10% distortion and also at the grid current starting point, as function of the load (R_a). Fig. 11 : $V_a = V_{g2} = 100$ V ; Fig. 12 : $V_a = V_{g2} = 170$ V.

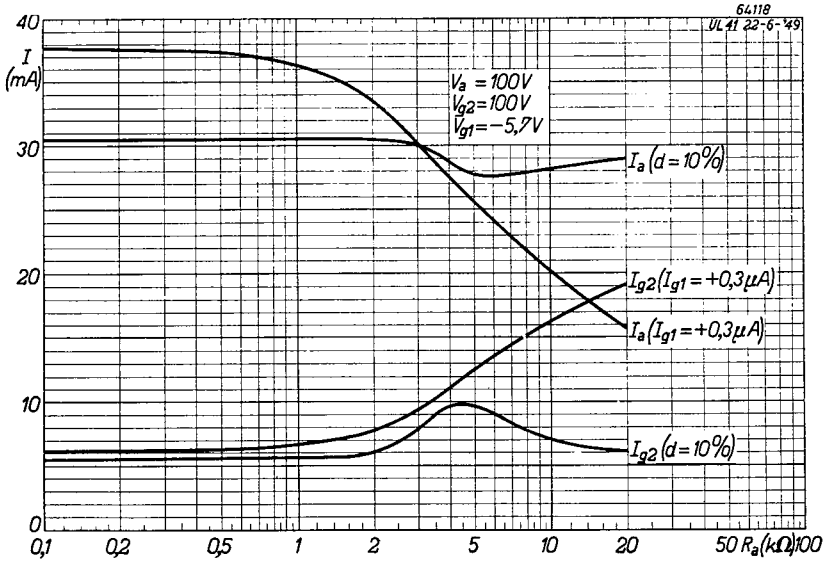

Fig. 13

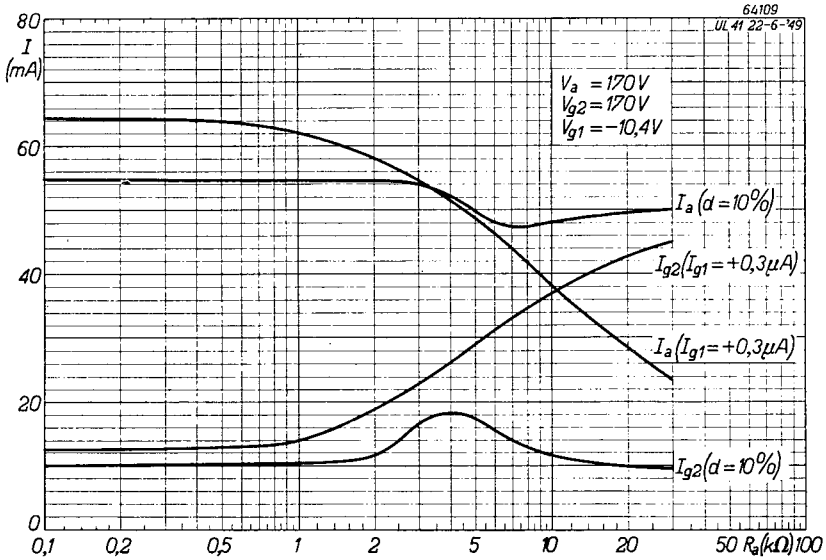

Fig. 14

Anode current (I_a) and screen grid current (I_{g2}) as functions of the load (R_a), with valve loaded to an extent such that a) the output is subject to 10% distortion ($d=10\%$), and b) grid current commences to flow ($I_{g1} = +0,3 \mu A$). Fig. 13 : $V_a = V_{g2} = 100 V$;
 Fig. 14 : $V_a = V_{g2} = 170 V$.

UY 41 Half-wave rectifying valve

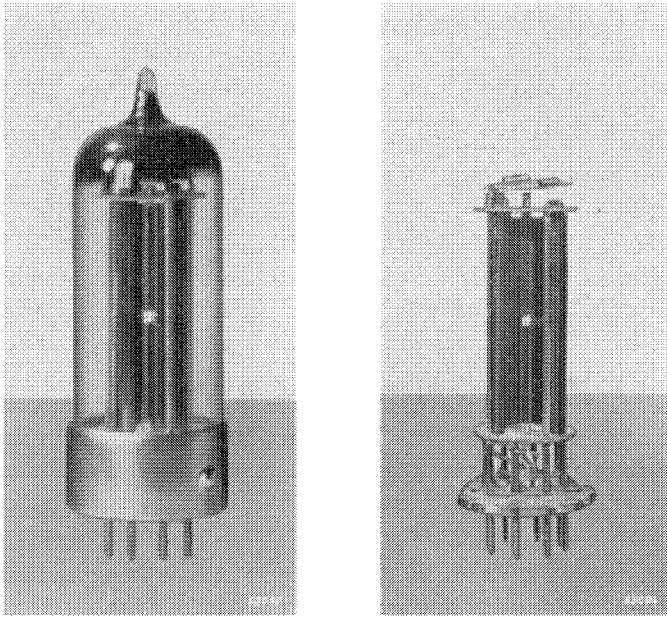

Fig. 1

The UY 41, showing the electrode system (approximately actual size).

The UY 41 is a high-vacuum, indirectly heated half-wave rectifying valve capable of delivering a maximum of 100 mA direct current. A simple receiver employing the UCH 42, 2 × UAF 42 and the UL 41 for 220 V mains operation would require a total current of roughly 80 mA, so that a single UY 41 will provide enough reserve current for an R.F. valve and a tuning indicator (UM 4).

At a low mains voltage (127 V) the anode current of a receiver of this type would be about 50 mA, and in this case the reserve of current of the UY 41 admits of the design of high-performance receivers with a push-pull output stage, of which the total anode current would be about 80 mA.

A suitable circuit for the UY 41 is shown in Fig. 2; here the smoothing filter consists of the electrolytic capacitors C_1 and C_2 with a 1200 ohm resistor. The anode voltage of the output valve is derived from C_1 , the other anode and screen grid voltages from C_2 . As a rule, a filter of this kind provides ample smoothing in a small receiver fitted with a loudspeaker giving moderate bass response, but in sets of higher quality it is advisable to incorporate a hum-bucking coil in the output transformer.

If a choke is used in place of the resistor in the smoothing filter, it must

UY 41

be remembered that the voltage drop across this choke will be roughly 10 V for a total anode current of 80 mA and a D.C. resistance of 125 ohms, assuming that the anode voltage of the output valve is taken from C_2 .

If the receiver is operated on 220 V mains, the voltage across C_1 is about 198 V, and that across C_2 188 V; with the smoothing resistor shown in Fig. 2 these values will be 198 V and 166 V respectively. As the maximum permissible anode dissipation of the valves is not to be exceeded, this increase in voltage must be taken into account when a choke is used, e.g. by adding a resistor in series, or by increasing the value of the limiting resistor in the anode circuit of the UY 41. On 200 to 220 V mains, a 160 ohm resistor would be needed for this purpose (see Fig. 2); on mains of less than 130 V the limiting resistor can be omitted, whilst for intermediate voltages the correct resistance value can be computed by linear interpolation. It should be noted that these are minimum resistance values (this is important when resistors with large tolerances are used).

In determining the wattage of the limiting resistor it is essential to take into account the ripple component of the current flowing through this resistor. Generally, the resultant wattage is about three times as high as that computed only from the D.C. component.

On mains of more than 220 V, or when a choke is used for the smoothing filter, the maximum permissible anode dissipation of the output valve is usually exceeded unless special measures are taken to prevent this. This can be suitably effected by increasing the limiting resistor.

Any parasitic R.F. currents flowing through the valve UY 41 may undergo modulation by the mains frequency, resulting in audible hum in the speaker, but a capacitor of $0.022 \mu\text{F}$ in parallel with the valve (see Fig. 2) will prevent this.

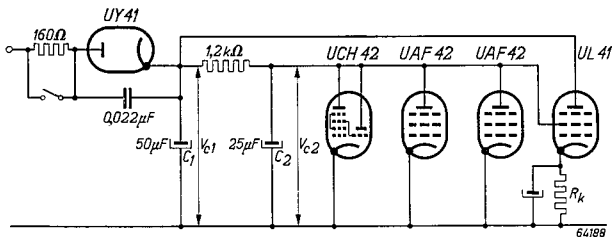

Fig. 2

Rectifier section of an A.C./D.C. receiver employing the UY 41 with a smoothing resistor. For details see text.

TECHNICAL DATA OF THE HALF-WAVE RECTIFIER UY 41

Heater data

Heating : indirect, A.C. or D.C., series feed

Heater current	I_f	=	100 mA
Heater voltage	V_f	=	31 V

Operating characteristics and limiting values

Mains voltage	V_i	=	127	220 max.	250 V_{RMS}
Rectified current	I_o	=	max. 100	max. 100	max. 100 mA
Limiting resistor	R_t	=	0 min.	160 min.	210 Ω
Input capacitance, smoothing filter	C_{flt}	=	max. 50	max. 50	max. 50 μF
Peak voltage between heater and cathode	V_{fk}	=	max. 550	max. 550	max. 550 V

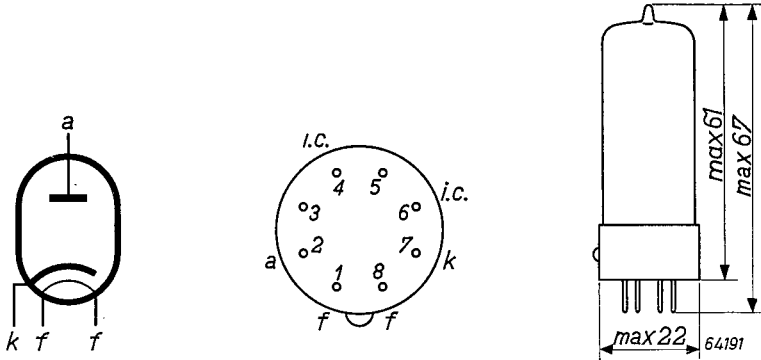

Fig. 3

Electrode arrangement, electrode connections and maximum dimensions in mm of the UY 41.

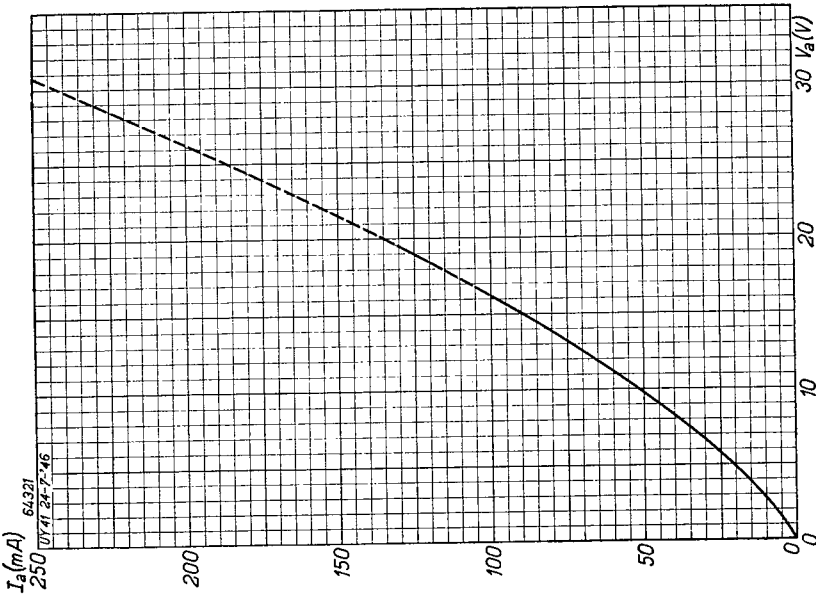

Fig. 4
Anode current (I_a) of the UY 41 as a function of the applied direct voltage (V_a).

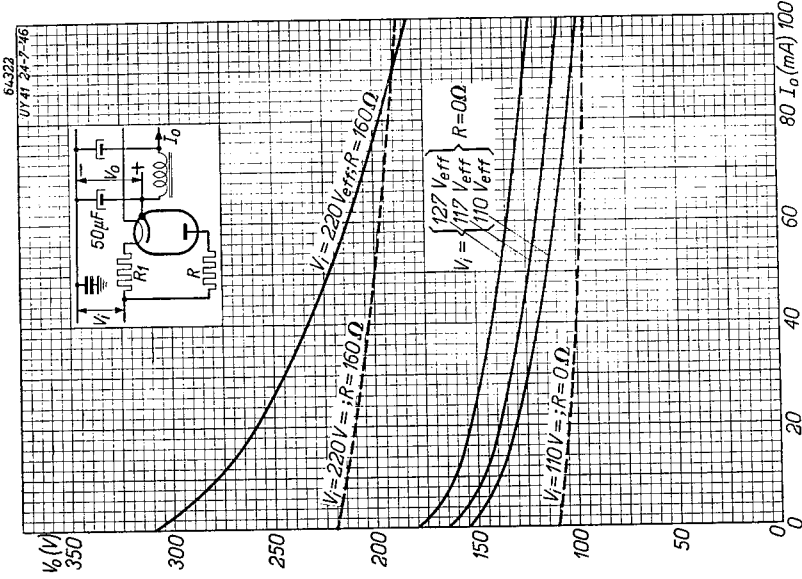

Fig. 5
Regulation of the UY 41 (output voltage V_o as a function of the direct current output I_o). Unbroken lines : valve operating on A.C. mains. Dotted lines : valve operating on D.C. mains.

UY 42 Half-wave rectifying valve

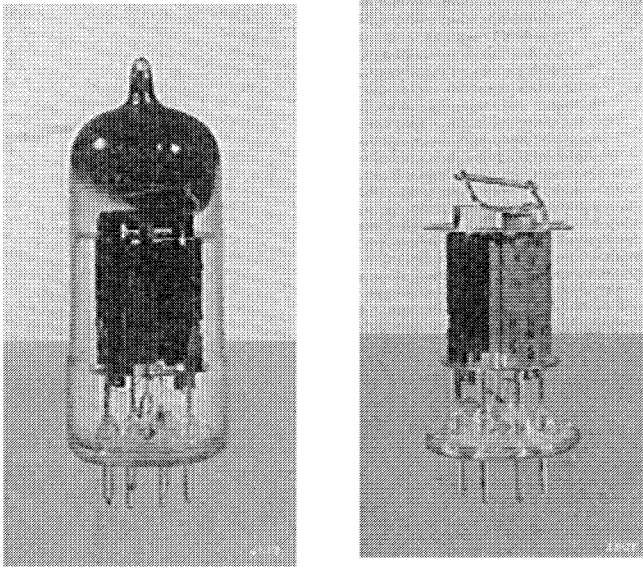

Fig. 1

The UY 42, showing the electrode system (approximately actual size).

The UY 42, in common with the UY 41, is a high-vacuum, indirectly heated half-wave rectifying valve capable of delivering a maximum of 100 mA direct current, but, whereas the UY 41 is suitable for all conventional mains voltages up to 250 V_{RMS} , the UY 42 can be used only at voltages up to 110 V_{RMS} . The reason for the development of this valve to supplement the UY 41 will be seen on comparing the regulation of the two valves for a mains voltage of 110 V: on A.C. mains, the D.C. output of the UY 42 is about 10 V greater than that of the UY 41, and on D.C. mains about 5 V greater. According to the operating characteristics of the output valve UL 41, such a rise in supply voltage increases the output of this valve by about 25% (roughly 12% on D.C. mains). In view of the relatively low output of the UL 41 at a supply voltage of the value in question, this may be regarded as a distinct advantage.

The higher output of the UY 42 has been secured by reducing considerably the internal resistance as compared with the UY 41 (cf. the I_a/V_a characteristics of the two valves).

If it is intended to employ the UY 42 on mains voltages over 110 V, a limiting resistor should be included in the anode circuit to suppress sputtering (momentary flash-over between anode and cathode). At the same time, this completely counteracts all the advantages of the valve, for which reason the UY 41 is the obvious choice for higher mains voltages.

UY 42

TECHNICAL DATA OF THE HALF-WAVE RECTIFIER UY 42

Heater data

Heating : indirect, A.C. or D.C., series feed

Heater current	I_f	=	100 mA
Heater voltage	V_f	=	31 V

Operating characteristics and limiting values

Mains voltage	V_i	= max.	110 V_{RMS}
Rectified current	I_o	= max.	100 mA
Input capacitance, smoothing filter	C_{fil}	= max.	50 μF
Limiting resistance	R_i	=	0 Ω
Peak voltage between heater and cathode	V_{fk}	= max.	350 V

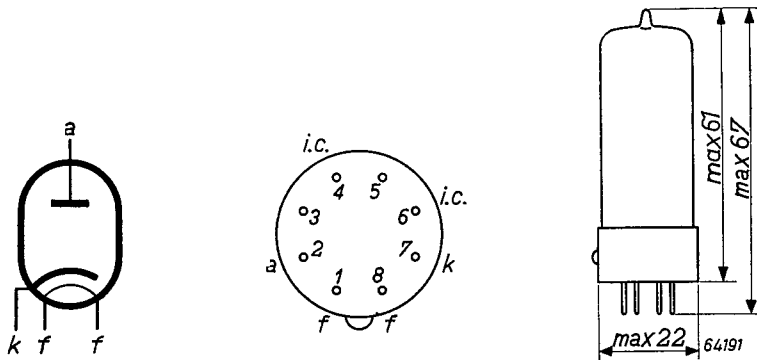

Fig. 2
Electrode arrangement, electrode connections and maximum dimensions in mm of the UY 42.

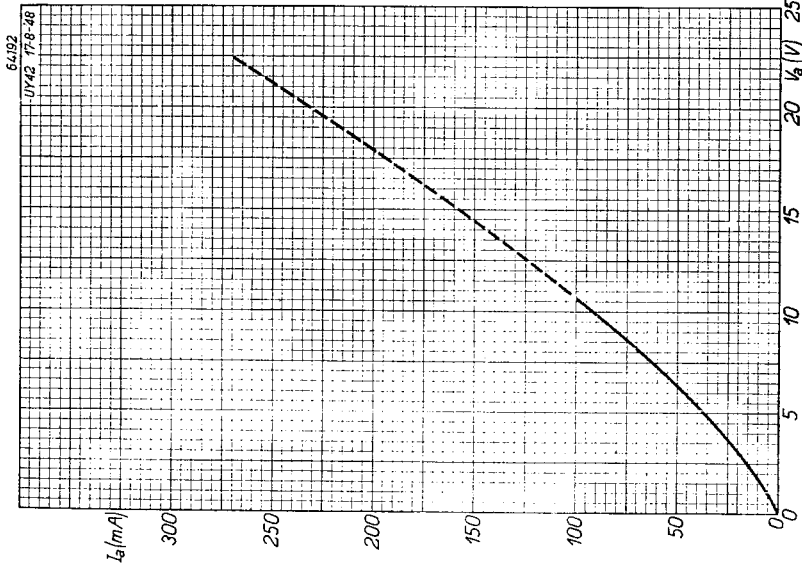

Fig. 3
Anode current (I_a) of the UY 42 as a function of the applied direct voltage (V_a).

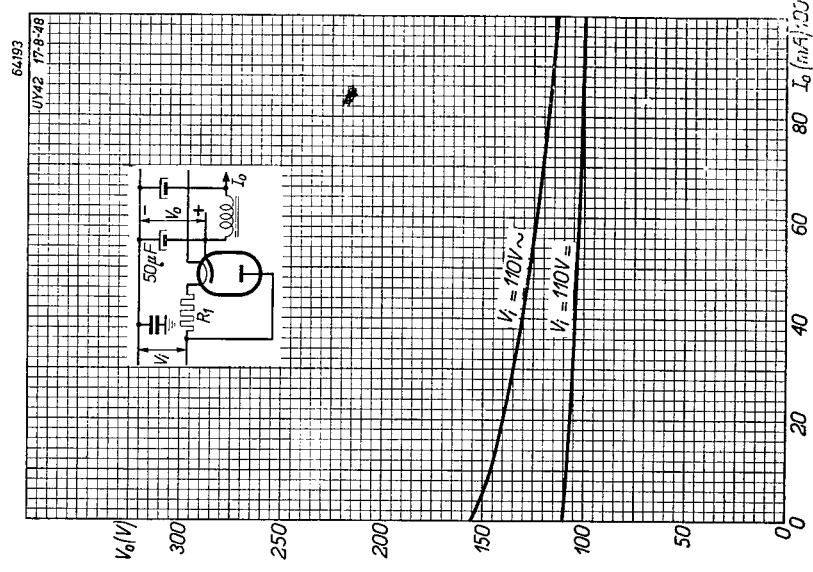

Fig. 4
Regulation of the UY 42 (output voltage V_o as function of the D.C. output current I_o).
Upper curve : valve operated on A.C. mains.
Lower curve : valve operated on D.C. mains.

U 30

U 30 Barretter

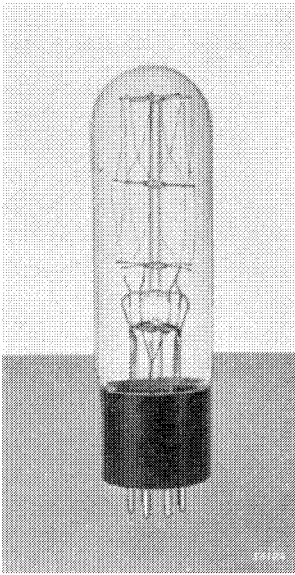

Fig. 1
The U 30 barretter ; overall height approximately 135 mm.

In A.C./D.C. receivers the heaters of the various valves are connected in series; the heater voltages of the U-valves are consequently so proportioned that the standardised series of valves UCH 42 - UF 41 - UBC 41 - UL 41 and UY 41, or UCH 42 - $2 \times$ UAF 42 - UL 41 and UY 41 requires a total heater voltage of some 116 V. These series can be used on 110 to 127 V mains without ballast resistance; on these low-tension mains supplies, the permissible voltage range is fairly wide owing to the fact that the resistance of the filaments increases with a rise in voltage, so that the current does not rise so much as the voltage.

In the case of 220 V mains, however, a resistor must be included in series with the filament circuit; a value of 1040 ohms is suitable for use with the above series of valves. The current is then much more dependent on the voltage, and the permissible voltage range is accordingly smaller.

Thus, when a ballast resistor is employed, certain precautions must be taken. For example, if mains-voltage fluctuations of 10% are to be admitted, the voltage range of the system

will be limited and the resistor will have to be provided with a fairly large number of tapings. On the other hand, if the U 30 is used instead of the series resistor, this barretter will ensure that the current is kept within the permissible limits.

The U 30 is designed for use with U-type valves (100 mA); the control range is such that the current adapts itself to the correct value for the normal broadcast series of valves on 220 V mains.

Owing to the high proportion of power dissipated by the U 30, it is not possible to make this barretter in the Rimlock design; the envelope is larger and the base is of the octal type. The practical effects of the controlling action of the U 30 are illustrated in Fig. 4 of circuit diagram VII.

TECHNICAL DATA OF THE BARRETTER U 30

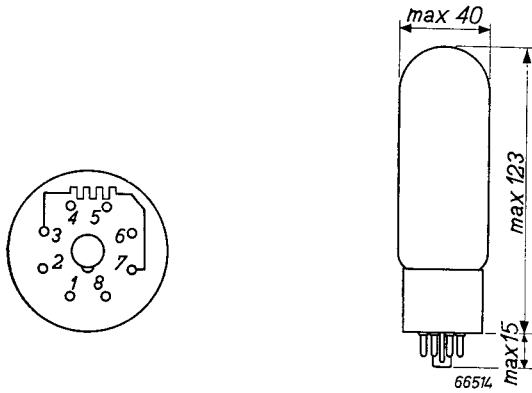

Fig. 2

Electrode connections and dimensions in mm of the U 30.

Control range		70—122.5 V
Current	nominal	100 mA
	max.	108 mA
	min.	87 mA
Mains voltage	max.	260 V
	min.	170 V

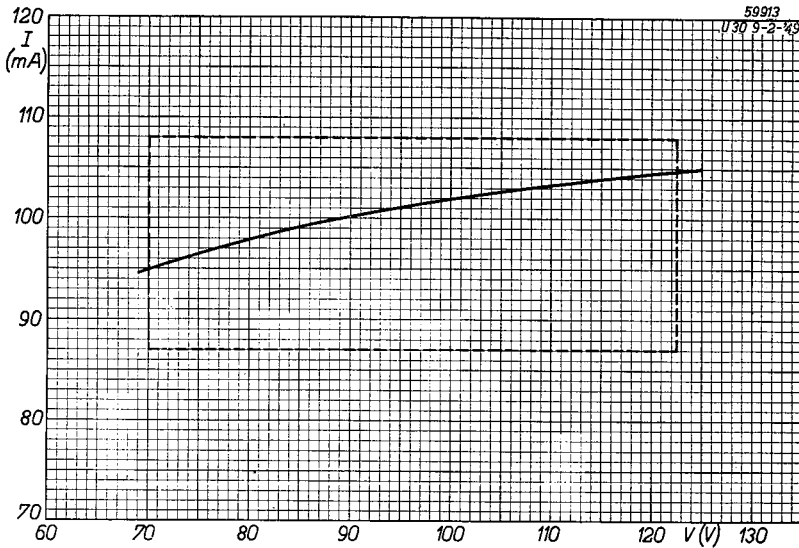

Fig. 3

Control characteristic of the U 30, current I flowing through the resistance wire as a function of the applied voltage V .

VII. A 5-valve receiver for A.C./D.C. mains

Introduction

Five Rimlock valves are used in this superheterodyne receiver, viz.

- UCH 42, triode-hexode frequency changer,
- UAF 42, detector diode + I.F. pentode,
- UAF 42, A.G.C. diode + A.F. pentode,
- UL 41, 9 W output pentode,
- UY 41, indirectly heated rectifier.

A U 30 barretter ensures that the performance of the receiver will not be greatly dependent on mains-voltage fluctuations: a drop in the nominal mains voltage of 220 V to 160 V does not noticeably affect the working of the set.

The receiver is designed for three wave-bands, two of which are short-wave bands :

- short wave I : 11.5 - 35 m (26.5 - 8.6 Mc/s),
- short wave II : 34 - 100 m (8.8 - 3 Mc/s),
- medium wave : 170 - 560 m (1750 - 530 kc/s).

The sensitivity of the receiver is very good, averaging 10 μ V.

Description of the circuit

Mixing stage

The aerial is coupled to the R.F. circuits by means of high-inductance coils, a fairly constant aerial gain is thus obtained over all three wave-bands. The actual coupling is such that a circuit with a quality factor $Q=100$ produces a voltage gain of 3 to 4.

In view of the very short wavelengths involved, the UCH 42 is recommended for this set. Owing to the satisfactory effective slope (0.7 mA/V) of the oscillator, it is possible to couple the oscillator coils loosely, this being not only convenient from the point of view of frequency drift, but essential to cover the required frequencies in the short-wave bands.

The fact that the tuned oscillatory circuit is connected to the anode circuit of the triode also tends to keep frequency drift within narrow limits, so that it is possible to apply the A.G.C. voltage to the grid of the mixer on short wavelengths as well.

In order that the required oscillator voltage can be attained on the shortest wavelength band, using the weakest possible coupling, an extra coil, L_s , in series with a capacitor of approximately 47 pF, is connected in parallel with the coupling coil L_p . The resonant frequency of this series circuit is slightly lower than the lowest frequency in the wave-band. Further details of this arrangement are given in the description of circuit I on page 123.

Proper earthing of the tuning capacitor is essential if instability and microphony are to be avoided on the shortest wavelengths (approx. 12 m). Anti-vibration mounting is recommended for the tuning capacitor, which may

otherwise prove to be a source of serious microphony. For the same reason it is advisable to secure the chassis in the cabinet by means of rubber mountings.

With a view to greater constancy of the oscillator voltage in the second wave-band, the lower end of the coupling coil L_{11} is connected to the top of the padding capacitor. This actually produces mixed feedback, that is, apart from inductive feedback, capacitive coupling across the padding capacitor.

Fig. 2 shows the oscillator grid current curves, which are a measure of the oscillator voltage as a function of the frequencies in the three wave-bands.

If an I.F. transformer is used with circuits having a quality factor of 140, the overall conversion gain of the UCH 42 is approximately 100.

The I.F. stage

The intermediate frequency is 452 kc/s. The pentode section of the first UAF 42 acts as amplifier. The anode of the I.F. valve can be connected, through a tap of 0.7, to the second transformer.

If circuits with a Q -factor of 140 are used in the second I.F. transformer also, and allowance be made for the tapplings on the circuit, a stage gain of 85 is obtainable with this valve.

Detection and A.G.C.

The diode of the first UAF 42 is employed as detector. In order to improve gramophone reproduction,

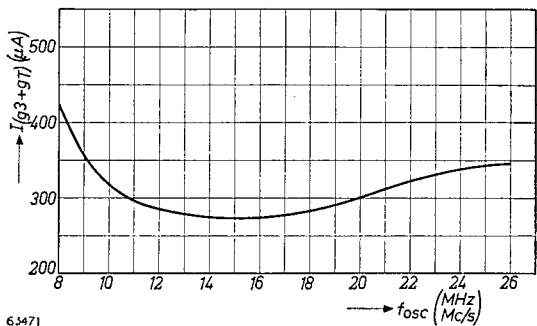
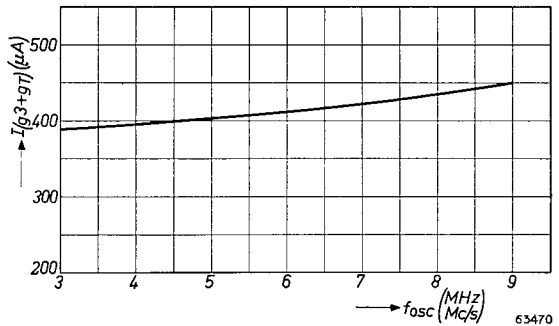
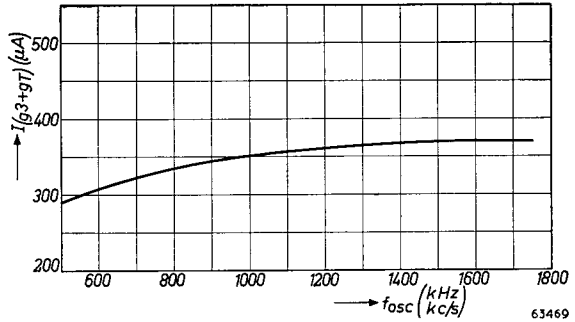

Fig. 2. Oscillator grid current as a function of the frequency in the three wave-bands.

which would otherwise be distorted by the parallel connection of the diode, an extra resistor of 47,000 ohms is connected in series with the 0,5 M Ω load resistor of the detector.

A.G.C. is provided by the diode in the second UAF 42. The delay voltage is produced by the voltage drop across a resistor of 27 ohm in the negative line of the power section; the value of this delay voltage should be such that A.G.C. comes into operation when the output valve UL 41 is fully loaded (see Fig. 3).

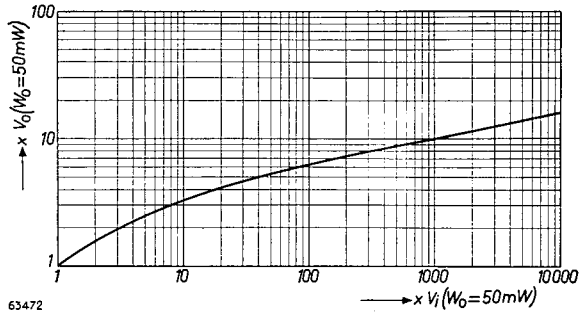

Fig. 3. A.G.C. curve relating to the receiver shown in Fig. 1.

into operation when the output valve UL 41 is fully loaded (see Fig. 3).

A.F. and output stage

The pentode section of the second UAF 42 serves as A.F. amplifier. In the absence of negative feedback, the amplification of this valve is 80, which is much too high from the point of view of microphony and hum, apart from the fact that the output valve would thus be fully loaded while the I.F. voltage on the detector diode is still inadequate (with the result that the diode would almost always be working on the curved part of the characteristic). For these reasons, part of the output voltage is returned, through a 1000 ohm resistor, to the 120 ohm resistor in the cathode circuit of the UAF 42. The resultant negative feedback ratio over the whole of the A.F. stage is 8, the total A.F. amplification being only 10. Owing to the presence of this negative feedback, distortion in the A.F. and output stages is considerably reduced, with corresponding improvement in the quality of the receiver. The grid leak of the UL 41 output valve takes the form of a potentiometer, the variable contact of which is connected to the anode of the output valve, through a capacitor of 270 pF. This simple arrangement ensures a very effective tone control.

The anode of the UL 41 is fed, through the primary winding of the output transformer, from the first electrolytic condenser of the smoothing filter. Accordingly, the anode voltage is approximately 170 V, at which value the output power of the UL 41 is about 4 W.

The power section

Power is supplied by a UY 41 rectifier. The smoothing circuit consists of a double electrolytic capacitor of $2 \times 50 \mu\text{F}$ and a 1200 ohm resistor. A barretter, type U 30, which takes the place of a resistor, is connected in series with the heaters of the receiving and rectifying valves. Fig. 4 clearly shows the advantages of using the barretter. Without this, a mains voltage

fluctuation from 220 to 190 V would have a pronounced effect on the sensitivity; the U 30 ensures that the voltage may drop as low as 165 V without producing any noticeable effects.

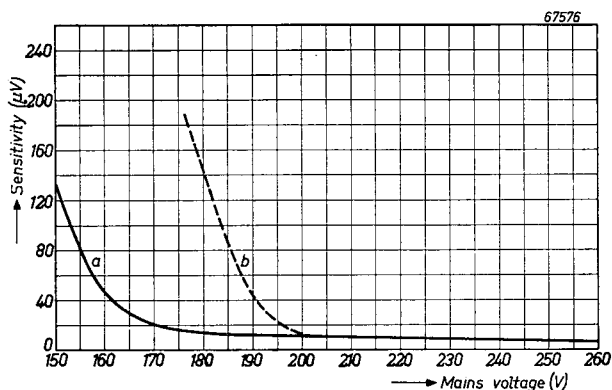

Fig. 4. Curves illustrating the sensitivity of the circuit in Fig. 1, as a function of the mains voltage. Curve *b* shows the results obtained in the absence of a barretter (the performance is noticeably affected at mains voltages under 190 V.) Curve *a* shows the performance when the barretter is included.

MEASURED VALUES

Voltages and currents on nominal mains voltage of 220 V.

Valve	Anode voltage	Screen grid voltage	Anode current	Screen grid current
UL 41 - output valve	170 V	165 V	52 mA	9.5 mA
UAF 42 - A.F. valve	60 V	38 V	0.46 mA	0.16 mA
UAF 42 - I.F. valve	165 V	85 V	5 mA	1.5 mA
UCH 42 - frequency changer Hexode section	165 V	85 V	2.4 mA	2.1 mA
Triode section	108 V	—	4.6 mA	—

Sensitivity, at a standard output power of 50 mW, measured at 1000 kc/s with 30% modulation:

At the control grid of the UL 41	approx.	600 mV _{RMS}
At the control grid of the second UAF 42	approx.	60 mV _{RMS}
At the detector diode (I.F.)	approx.	200 mV _{RMS}
At the control grid of the first UAF 42	approx.	3.4 mV _{RMS}
At the control grid of the UCH 42	approx.	34 μV _{RMS}
At the aerial	approx.	10 μV _{RMS}

Selectivity, measured at a frequency of 1000 kc/s:

Attenuation : 0.1	when the receiver is detuned	± 5 kc/s,
0.01	when the receiver is detuned	± 8 kc/s,
0.001	when the receiver is detuned	± 11 kc/s.

VIII. A 4-valve A.C./D.C. superheterodyne receiver

INTRODUCTION

Four Rimlock valves are used in this model, viz.

UCH 41, or UCH 42 — triode-hexode frequency changer.

UAF 42 — detector diode and I.F. amplifier,

UL 41 — 9 W output pentode,

UY 41 — indirectly heated rectifier.

The receiving section contains only three valves. By using the third grid of the UAF 42 as a diode it is possible to provide a delay voltage for the A.G.C. and thus obtain maximum output power at an input signal of comparatively low strength.

Assuming that the I.F. coils have a quality factor Q of 140, the sensitivity on 220 V mains is about $45 \mu\text{V}$ with the UCH 41, or roughly $32 \mu\text{V}$ with the UCH 42; on 110 V mains supply the values are 82 and $52 \mu\text{V}$ respectively.

The wave-bands are as follows :

long waves:	approx. 800-2000 m,
medium waves:	approx. 200- 600 m,
short waves:	approx. 15- 50 m.

DESCRIPTION OF THE CIRCUIT

The mixing stage

The coupling of the aerial to the R.F. circuit is of the "high-inductance" kind, giving an average aerial gain of 4 to 5, with a circuit quality factor $Q=100$.

A choice of two frequency changers is available: the UCH 41 with its conversion slope of $450 \mu\text{A/V}$ at $V_b=170 \text{ V}$, or $320 \mu\text{A/V}$ at $V_b=100 \text{ V}$, or the much superior UCH 42 ($S_c=670$ and $530 \mu\text{A/V}$ at $V_b=170$ and 100 V respectively).

In order to ensure satisfactory performance by the frequency changer, it is of course essential so to couple the oscillator coils that the necessary oscillator voltage is obtained over the entire wave-band. In the case of the UCH 41, an oscillator-grid current of roughly $320 \mu\text{A}$ through the $22 \text{ k}\Omega$ grid leak is needed for this purpose, and with the UCH 42 about $200 \mu\text{A}$ through the $47 \text{ k}\Omega$ grid leak; on 110 V mains the appropriate values are 200 and $100 \mu\text{A}$ respectively. In either case, a grid capacitor of about 47 pF is used. The consequences of insufficient grid current (i.e. inadequate oscillator voltage) are increased valve noise, less conversion gain and possibly complete interruption of the oscillation at one particular point of the wave-band.

On the other hand, too much grid current (when the coil coupling is too tight) can lead to increased whistling and squegging. Since the latter is most likely to occur at the lower end of the short-wave band, an extra coil (L_{13})

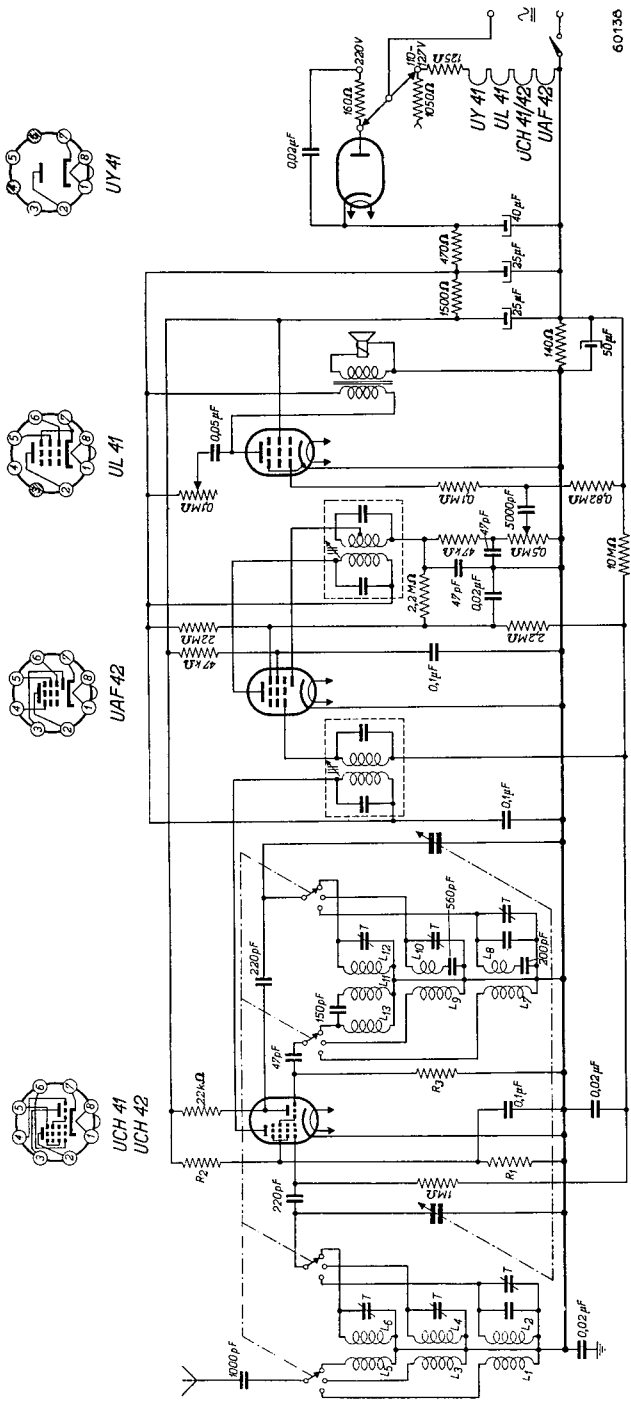

Fig. 1.
Circuit of a 4-valve superheterodyne receiver.

in series with a capacitor of about 150 pF is connected across the coupling coil (the effects of this extra coil are described in detail on page 123 of circuit description I). The resonant frequency of this circuit is approx. 4.75 Mc/s, which is below the lowest oscillator frequency. The quality of the coil L_{13} is not critical; a quality factor of 40 was employed in the laboratory model. Although only a loose coupling between the coil L_{13} and the coils L_{11} and L_{12} is permissible, all three can still be wound on the same bobbin; an advantage of the extra coil is that L_{11} and L_{12} can be loosely coupled, so that the parasitic capacitance across L_{11} (input capacitance of the triode section of the valve + wiring capacitance + self capacitance of L_{11}) is not transferred to L_{12} to the same extent. Variations in the input capacitance of the triode section occurring whilst the valve is warming up, or due to control being applied to the hexode section, then have less effect on the oscillator frequency. Another advantage of this arrangement is that the oscillator voltage is more constant in the short-wave band: the oscillator grid current through the grid leak R_3 (which is a measure of the oscillator voltage) does not fluctuate by more than 20%, whereas fluctuations to the extent of 1 : 2 occur when the extra coil is not used. The most appropriate values for the coupling $t = M/L$ of the oscillator coils, relating to the valves UCH 41 and UCH 42, are specified in the following table :

	Short waves	Medium waves	Long waves
UCH 41	0.67	0.32	0.26
UCH 42	0.4	0.24	0.16

In view of the possibility of squegging, it is not advisable to employ higher values for the grid capacitor and leak than those specified in the circuit diagram.

The screen grids of the frequency changer (whether a UCH 41 or a UCH 42) are fed by means of a potentiometer, suitable values of which — as well as for the grid leak — are given below:

	R_1	R_2	R_3
UCH 41	47 k Ω	22 k Ω	22 k Ω
UCH 42	27 k Ω	18 k Ω	47 k Ω

The intermediate frequency is 452 kc/s; whether or not this will be the most appropriate value naturally depends on local circumstances.

If the I.F. transformer incorporates 100 pF tuning capacitors, critical coupling and a quality factor Q of 140 (e.g. a Philips I.F. transformer type 5730), the conversion gain of the mixing stage is 90, using the UCH 41, with a feed of 170 V, i.e. on 220 V mains, or 125 with the UCH 42.

The I.F. stage

The pentode section of the UAF 42 serves as I.F. amplifier, the diode of this valve being connected to a tapping ($t=0.7$) on the second circuit of the last I.F. transformer. Provided that the quality factor Q of this transformer is also 140 and that tuning capacitors of 100 pF are used, the overall I.F. gain will be roughly 160 with the maximum supply voltage.

Although still higher amplification can be obtained by using circuits of better quality, it should be kept in mind that on very strong aerial signals (e.g. of the order of 2 V) the A.G.C. is not capable of so reducing the amplification of the I.F. valve that this valve will not be overloaded. If necessary, overloading can be prevented by tightening the coupling of the last I.F. transformer.

The screen grid of the UAF 42 is fed through a series resistor, producing the so-called sliding screen grid voltage. As an alternative, the screen grid feed may be taken from the potentiometer used for the frequency changer, but the A.G.C. characteristic is then not so good.

Detection and A.G.C.

The I.F. signal is detected by the diode of the UAF 42; the value of the D.C. voltage across the detector load resistor is proportional to the average amplitude of the I.F. signal. This voltage is used as A.G.C. voltage for the frequency changer and the I.F. valve.

To ensure a sufficiently flat A.G.C. characteristic, the third grid of the UAF 42 is connected as a delay diode; this arrangement is fully described on page 139 of circuit description III. This grid is fed through a high-value resistor (about 22 M Ω) and is connected also, through a 2.2 M Ω resistor, to the detector load resistor.

The A.G.C. comes into operation immediately the voltage across the detector load resistor increases to such an extent that no current flows to the third grid. The values of the resistors in this circuit are such that the A.G.C. comes into operation only when the output valve is fully loaded.

The output stage

The biasing voltage for the UL 41 is provided by a 140 ohm resistor in the negative line of the power section. On strong aerial signals, the currents flowing in the frequency changer and I.F. valve are reduced by the A.G.C. and, in consequence, the grid bias of the UL 41 also drops; the value of the bias resistor, however, is such that the anode dissipation of the output valve remains just within the 9 W limit on an aerial signal of 1 V.

At a supply voltage of approx. 165 V, corresponding to a mains voltage of 220 V, the UL 41 delivers roughly 4 W, but on 110 V mains the output is not more than about 1.25 W.

A 50,000 pF capacitor in series with a variable 0.1 M Ω resistor is connected across the primary of the output transformer, thus providing a simple but effective tone control.

The power section

The rectifying valve is the UY 41. On 220 V mains, a 1050 + 125 ohm resistor is connected in series with the heaters, and a protective resistor of 160 ohms is included in the anode circuit. As an alternative to the 1050 ohm resistor, a U 30 barretter may be used, this having the advantage that the performance of the receiver is then less dependent on voltage fluctuations (see also circuit VII, page 257).

On 110 to 127 V mains a 125 ohm resistor is placed in series with the heaters; the protective resistor is omitted. The sequence of the heater connections is such that the possibility of modulation hum is reduced to a minimum. If the receiver need be suitable for 110 V mains only, it is advisable to substitute a UY 42 rectifier for the UY 41; the output power is then about 1.5 W.

Selectivity, measured at 1000 kc/s

Attenuation : 1 : 10 when the receiver is detuned ± 4.35 kc/s,
 1 : 100 when the receiver is detuned ± 9 kc/s,
 1 : 1000 when the receiver is detuned ± 15.25 kc/s.

Sensitivity, with the standard output power of 50 mW, measured at 1000 kc/s with 30% modulation:

Mains voltage	220 V		110-127 V	
At the control grid of the UL 41	0.5 V _{RMS}		0.55 V _{RMS}	
At the control grid of the UAF 42	16 mV _{RMS}		21 mV _{RMS}	
At the control grid of the freq. changer	UCH 41	UCH 42	UCH 41	UCH 42
At the aerial	180 μ V _{RMS}	130 μ V _{RMS}	330 μ V _{RMS}	210 μ V _{RMS}
	45 μ V _{RMS}	32 μ V _{RMS}	82 μ V _{RMS}	52 μ V _{RMS}

IX. An 8-valve A.C./D.C. superheterodyne receiver with push-pull output stage

Introduction

This circuit was designed especially for high output power on 110 V mains, this being achieved by using two valves type UL 41 in push-pull, in conjunction with a voltage-doubling circuit in the power section. This arrangement enables the receiver to be operated on 110 V to 127 V A.C. mains, as well as 220 V A.C. or D.C. mains.

The following valves are used :

- UCH 42, or UCH 41 — frequency changer,
- UAF 42 — I.F. valve and A.G.C. diode,
- UAF 42 — A.F. valve and detector diode.
- 2 × UL 41 — output valves in push-pull,
- 2 × UY 41 — rectifying valves,
- UM 4 — tuning indicator.

Although the receiver is designed primarily for two wave-bands, it can naturally be modified to accommodate more.

DESCRIPTION OF THE CIRCUIT

The mixing stage

This part of the circuit is identical with that of the circuit VII. The use of the UCH 42 ensures greater sensitivity, as well as a better signal-to-noise ratio particularly in the short-wave range.

The respective values of the resistors R_1 and R_2 are 27 and 18 k Ω for use with the UCH 42, or 47 and 22 k Ω with the UCH 41.

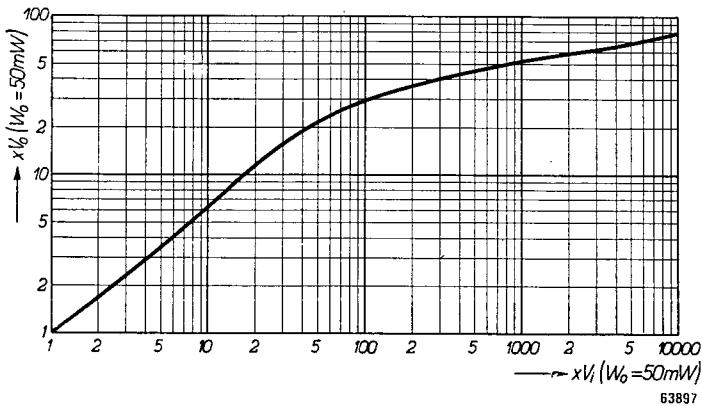

Fig. 2. The A.G.C. characteristic.

The I.F. stage

The first UAF 42 serves as I.F. amplifier, the diode functioning as rectifier for the A.G.C. voltage. An 18 ohm resistor in the negative line of the power section provides the delay voltage, as well as the grid bias for the frequency changer and the I.F. valve. Fig. 2 shows the A.G.C. characteristic of the receiver.

A.F. section

The second UAF 42 is the A.F. amplifier and phase inverter, with resistors of 0.1 M Ω and 0.12 M Ω in the anode and cathode circuits respectively; the coupling resistance in the cathode circuit is slightly higher than that in the anode circuit in view of the fact that for A.F. currents the cathode resistor is connected in parallel with the screen grid resistor. The amplification of this stage is about 20. Parasitic capacitances with the diode circuit, which might be detrimental to the push-pull action at the higher frequencies, are compensated by a capacitor of 100 pF connected across the cathode resistor. A simple tone control is provided by connecting between the control grids of the output valves UL 41 a network comprising a capacitor of 2200 pF, a 27 k Ω resistor and a 0.5 M Ω potentiometer.

The feedback circuit is such that there is no reduction in gain when the volume control is set to maximum. Winding S_5S_5' of the output transformer provides a negative feedback voltage and winding S_6S_6' a positive feedback voltage, which just compensate each other at the maximum setting of the volume control. When the volume is reduced, for instance when the signal received is fairly strong, the feedback voltage from winding S_6S_6' predominates. Fig. 3 shows the response characteristics of the A.F. section when the volume control is:

- a. at a setting corresponding to 1/10 of its total resistance,
- b. at maximum setting.

The power section

The output of the receiver is also quite high on the lower mains voltages, this being ensured by using two rectifiers type UY 41 as voltage doublers on mains voltages of 110 to 127 V; when operated on 220 V they are connected in parallel.

To ensure that the rectified direct current will not exceed the permissible maximum of 100 mA on mains voltages of 110 to 127 V, the screen grids of the output valves are operated at half the supply voltage. In Fig. 1 the switch connections for 110 V are indicated by means of full lines, and those for 220 V by dotted lines. The matching resistance between the anodes of the output valves is 8000 ohms at 110 V to 127 V, and 5000 ohms at 220 V; it is therefore necessary that the speaker transformer be provided with a tapping, which can be switched on changing over from low mains voltage to high, and vice-versa.

The output is about 4.4 W at 110 V, 6.3 W at 127 V and 7.3 W at 220 V, with 10% distortion.

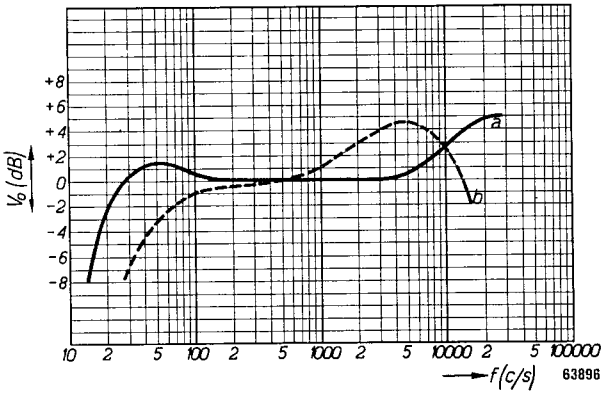

Fig. 3. Response characteristic of the A.F. section with the volume control at :
 a. 1/10 of its total resistance,
 b. maximum setting.

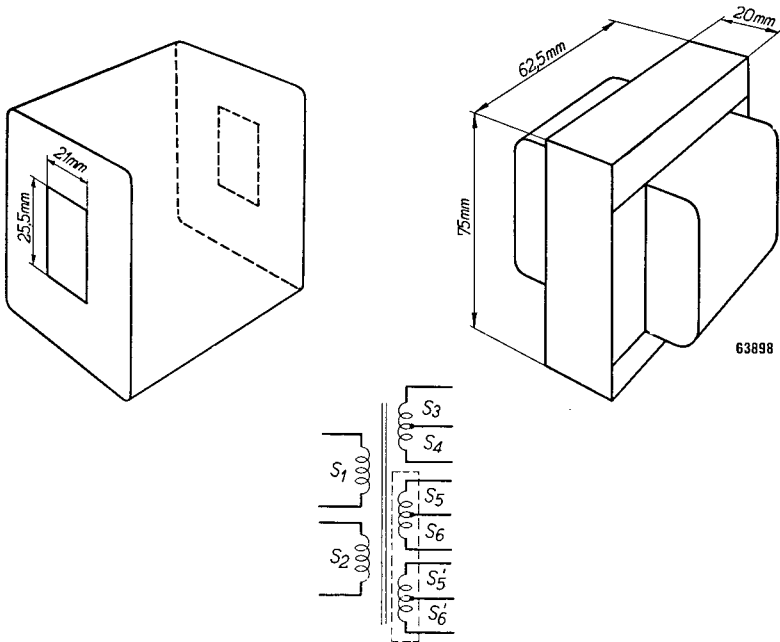

Fig. 4. Dimensions of the output transformer.

MEASURED VALUES

Voltages and currents of the output stage

Mains voltage	Modulation	Anode current mA	Screen grid current mA
110 V A.C.	No signal	36	4.6
	Full without A.G.C.	42	7.8
127 V A.C.	No signal	43	5.6
	Full without A.G.C.	55	11
220 V A.C.	No signal	75	15
	Full without A.G.C.	80	36

Mains voltage	Modulation	Voltage across				
		C_1	C_2	C_3	C_4	C_5
110 V A.C.	No signal	202 V	182 V	170 V	92 V	88 V
	Full without A.G.C.	190 V	173 V	163 V	86 V	81 V
127 V A.C.	No signal	235 V	210 V	197 V	110 V	107 V
	Full without A.G.C.	220 V	197 V	186 V	100 V	95 V
220 V A.C.	No signal	214 V	179 V	169 V	—	—
	Full without A.G.C.	203 V	152 V	142 V	—	—

Sensitivity, as measured at an output power of 50 mW, using a signal with 30% modulation at 400 c/s. :

At the control grids of the UL 41	2×400 mV _{RMS}
Between control grid and cathode of the A.F. valve UAF 42	20 mV _{RMS}
At the control grid of the I.F. valve UAF 42	0.87 mV _{RMS}
At the control grid of the UCH 42 (at 1 Mc/s)	10 μ V _{RMS}
At the aerial (at 1 Mc/s)	approx. 3 μ V _{RMS}

Winding data of the output transformer

Winding	Number of turns	Wire diameter
S_1	1650	0.16 mm
S_2	1650	0.16 mm
$S_3 - S_4$	21 + 83	0.8 mm
$S_5 - S_6$	21 + 83	0.1 mm
$S_5' - S_6'$	21 + 83	0.1 mm

The windings $S_5 - S_6$ and $S_5' - S_6'$ are connected in parallel and are wound in such a way as to ensure the least possible leakage inductance with respect to S_1 and S_2 .

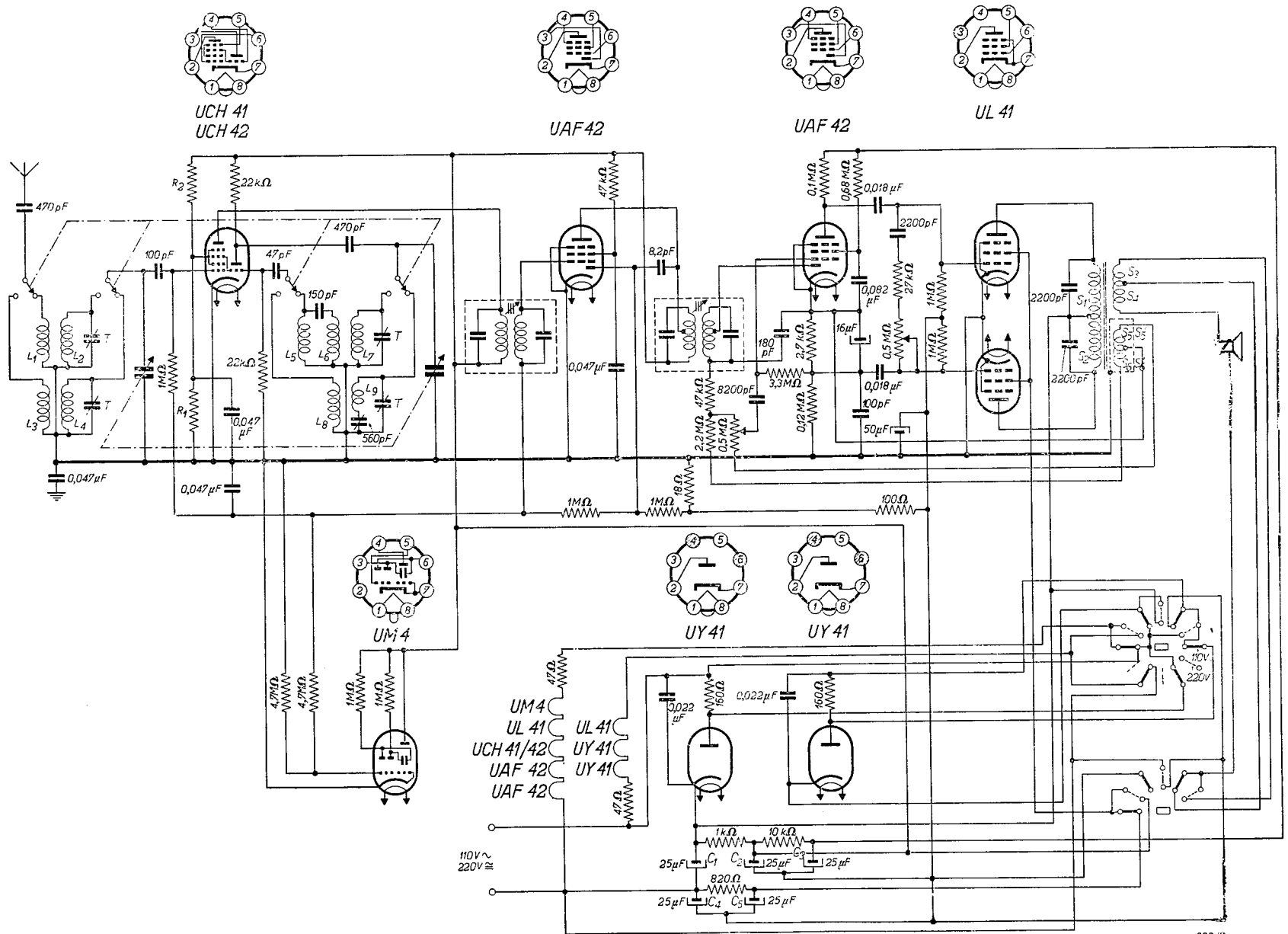

Fig. 1. An 8-valve superheterodyne A.C./D.C. receiver with voltage-doubling circuit on low mains voltages

The Rimlock D-range of broadcast valves

Battery receivers generally may be divided into two fairly distinct groups, according to their size, cost and, hence, their performance. The first group comprises portable sets intended to provide entertainment and amusement on journeys or holidays. Since portability is naturally the principal feature of such receivers, small dimensions and light weight are essential, and to this end battery manufacturers have recently placed on the market batteries which, as regards size and weight, are a great improvement on earlier types. Now, to avoid excessive drain on these batteries, the valves used in portable receivers must give reasonable performance on low voltages, with low consumption. Although, for reasons of economy, low consumption has been the constant aim of manufacturers in the development of battery valves, renewed efforts in this direction have lately produced some highly satisfactory results.

The second group of battery receivers comprises those which, when electrical supplies are not available, take the place of a mains set. In such cases, small dimensions are naturally not so important, and will be frequently even undesirable. Current consumption is then also a less vital factor, but is nevertheless always borne in mind by the designers, from the point of view of economy. The quality of the response and the output power of the valves are now the more important features, necessitating valves of high quality. A series of Rimlock type battery valves has now been introduced which meets the conditions imposed by receivers in both categories, low consumption and locking design being specially adapted to the needs of portable sets, whilst their high performance comes to the fore in table models.

The filaments of Rimlock D-valves can be supplied from a dry battery with a nominal voltage of 1.4 V, the total filament current of all these valves being 200 mA (150 mA in an economy circuit). The total current consumed by the positive electrodes is about 15 mA (about 9 mA in an economy circuit) at an anode voltage of 90 V.

Rimlock valves are also suitable for receivers operating on a vibrator and accumulator, and in the so-called "ABC" sets, which can be operated either on batteries or on A.C./D.C. mains. In such cases it is usual to connect the filaments in series (filament current 50 mA) and it should be noted that the filament current is usually subject to greater fluctuations on series feed than in the parallel arrangement. For example, in a receiver operating on 110 or 220 V mains, a resistor of high value compared with the total resistance of the filaments must be connected in series with the filaments, so that the amount of current is governed almost entirely by this resistor; any rise in mains voltage then produces a corresponding rise in the filament current, which in turn increases the filament resistance, with the result that the percentage rise in the voltage across the filaments is roughly twice as high as that of the mains voltage. In order to avoid any serious consequences, the resistance in series with the filaments should always be such that the nominal voltage across each filament is 1.3 V, thus leaving enough

reserve to avoid any undesirable consequences arising from a possible variation of 10% in the mains voltage.

The Rimlock D-range comprises the following valves:

- DK 40, a heptode frequency changer with an excellent performance, the conversion conductance being $425 \mu\text{A}/\text{V}$ at the working point. The filament current of this valve is 50 mA.
- DAF 40, a diode-R.F. pentode with a slope of $0.7 \text{ mA}/\text{V}$ at an anode current of 0.85 mA. This valve, like the DAF 41 mentioned below, takes a filament current of 25 mA. In a 50 mA series chain, the filaments of these two valves may be connected in parallel.
- DAF 41, a diode-A.F. pentode, again with a slope of $0.7 \text{ mA}/\text{V}$ at an anode current of 0.85 mA. As a complete set of D-type valves includes 2 diodes, delayed A.G.C. may be employed.
- DL 41, an output valve capable of delivering 360 mW at an anode and screen grid voltage of 90 V, or 600 mW at 120 V. Two of these valves in class B push-pull give an output of roughly 2 W at 150 V, which approximates to the output of a conventional mains receiver. The filament of this valve is made in two halves, each taking 50 mA at 1.4 V, and these may be connected in series for a 50 mA chain.

DAF 40

DAF 40 Diode-R.F. pentode battery valve

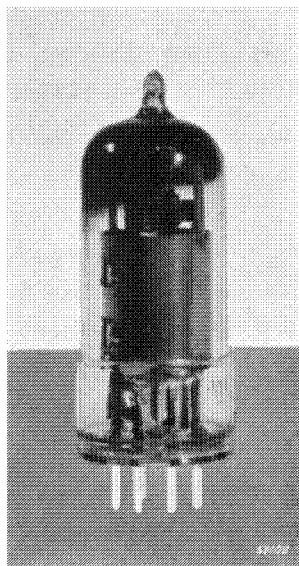

Fig. 1
The DAF 40, approximately actual size.

The DAF 40 is a diode-pentode for battery operation; the pentode section is designed for R.F. and I.F. amplification, the diode section for detection and A.G.C. A battery with a nominal voltage of 1.4 V can be used for the filament, which consumes only 25 mA. Since the valve is suitable for series feeding, it can also be used in mains receivers, as well as for battery receivers employing a vibrator. As the filament current in such sets is usually 50 mA, the filament of the DAF 40 can in such cases be connected in parallel with that of the DAF 41 (A.F. amplifier) to obtain a total filament current of 50 mA. Further, in receivers of this kind, the filament voltage should be limited to 1.3 V, to ensure that the filament will not be overloaded as a result of fluctuations in the mains or accumulator voltage. It may also be necessary to connect a resistor across the two filaments, to prevent an increase in filament current due to the cathode currents of the other valves.

Under normal operating conditions, the maximum permissible anode voltage of the DAF 40 is 135 V, and the maximum screen grid voltage is 85 V, but when the output stage is without input signal, the supply voltage is liable to increase considerably, particularly in a set with Class B push-pull output and using a vibrator unit. This should be borne in mind in connection with the working point of the DAF 40, and provision should be made to ensure that the voltages applied to the valve are not excessive in the absence of an input signal.

On the other hand, when the valve is biased to cut-off, anode and screen grid voltages of up to 180 V are permissible; such conditions may occur when powerful signals are received and a large A.G.C. voltage is applied to the DAF 40, the volume control of the receiver in question being turned back.

The slope of the DAF 40 is 0.7 mA/V for an anode current of 0.85 mA, and the internal resistance is 1.7 - 2.6 M Ω (dependent on the anode voltage); the anode-to-grid capacitance is less than 0.0065 pF.

TECHNICAL DATA OF THE DIODE-PENTODE DAF 40

Filament data

Heating: direct, from battery, rectified A.C., or D.C.; series or parallel feed

In parallel with other valves :

Filament voltage	V_f	=	1.4 V
Filament current	I_f	=	25 mA

In series with other valves :

Filament voltage	V_f	=	1.3 V
----------------------------	-------	---	-------

Capacitances (measured on the cold valve)

Input capacitance	C_{g1}	=	2.8 pF
Output capacitance	C_a	=	3.7 pF
Between anode and control grid	C_{ag1}	<	0.0065 pF
Between diode anode and cathode	C_d	=	2.1 pF
Between pentode anode and diode anode	C_{ad}	<	0.1 pF
Between pentode control grid and diode anode	C_{g1d}	<	0.003 pF

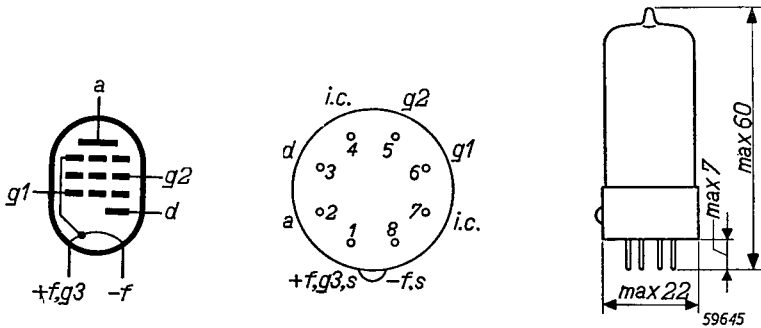

Fig. 2
Electrode arrangement, electrode connections and dimensions in mm of the DAF 40.

DAF 40

Operating characteristics of the valve used as R.F. or I.F. amplifier

Anode and supply voltage	$V_a = V_b =$	67.5	90	V
Screen grid resistor	$R_{g2} =$	0	120	k Ω
Grid bias	$V_{g1} =$	0—3.7	0 —5	V
Screen grid voltage	$V_{g2} =$	67.5 67.5	67.5 90	V
Anode current	$I_a =$	0.85 —	0.85 —	mA
Screen grid current	$I_{g2} =$	0.2 —	0.2 —	mA
Mutual conductance	$S =$	700 7	700 7	$\mu\text{A/V}$
Internal resistance	$R_i =$	1.7 >10	2.2 >10	M Ω
Amplification factor of grid 2 with respect to grid 1	$\mu_{g2g1} =$	32 —	32 —	
Equivalent noise resistance	$R_{eq} =$	8.7 —	8.7 —	k Ω
Anode and supply voltage	$V_a = V_b =$		120	V
Screen grid resistor	$R_{g2} =$		270	k Ω
Grid bias	$V_{g1} =$		0—6.8	V
Screen grid voltage	$V_{g2} =$		67.5 120	V
Anode current	$I_a =$		0.85 —	mA
Screen grid current	$I_{g2} =$		0.2 —	mA
Mutual conductance	$S =$		700 7	$\mu\text{A/V}$
Internal resistance	$R_i =$		2.6 >10	M Ω

Limiting values of the pentode section

Anode voltage, valve biased to cut-off	V_{a_o}	= max.	180	V
Anode voltage	V_a	= max.	135	V
Anode dissipation	W_a	= max.	0.2	W
Screen grid voltage, valve biased to cut-off	V_{g2_o}	= max.	180	V
Screen grid voltage	V_{g2}	= max.	85	V
Screen grid dissipation	W_{g2}	= max.	0.02	W
Grid current starting point	$V_{g1} (I_{g1} = +0.3\mu\text{A})$	= max.	-0.2	V
Cathode current	I_k	= max.	1.2	mA
External resistance between control grid and filament	R_{g1}	= max.	10	M Ω

Limiting values of the diode section

Peak inverse voltage	$V_{d\text{inv}p}$	= max.	100	V
Diode current	I_d	= max.	0.2	mA
Peak diode current	I_{dp}	= max.	1.2	mA

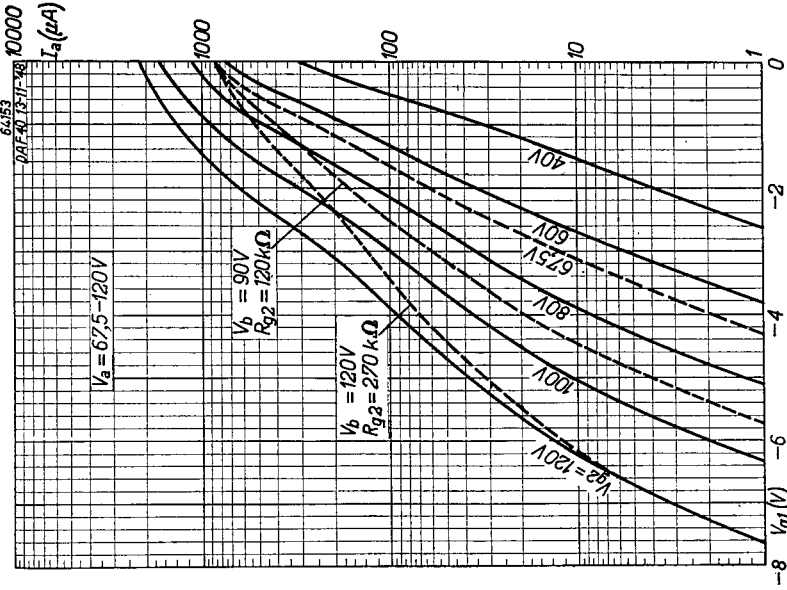

Fig. 3

Anode current (I_a , Fig. 3) and mutual conductance (S , Fig. 4) as functions of the grid bias (V_{g1}), with screen grid voltage (V_{g2}) as parameter. The dotted curves represent the anode current (Fig. 3) and mutual conductance (Fig. 4) at supply voltages of 120 and 90 V.

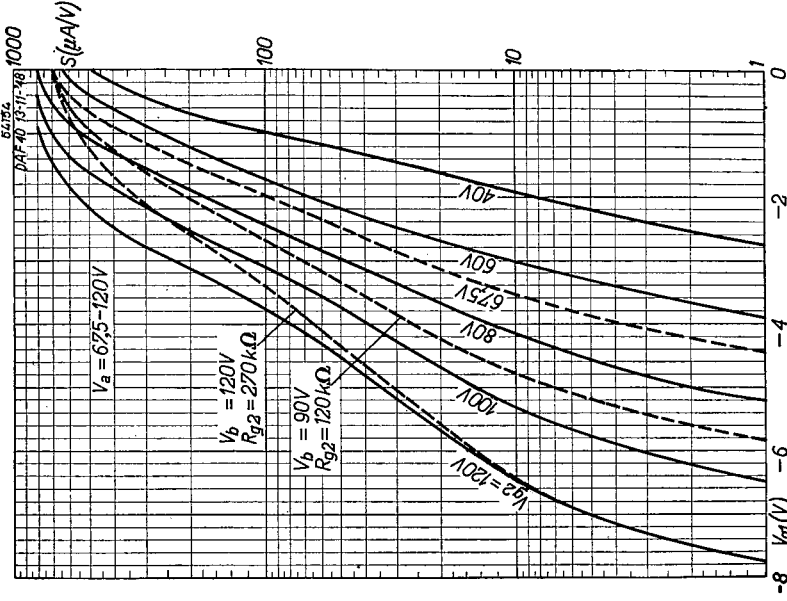

Fig. 4

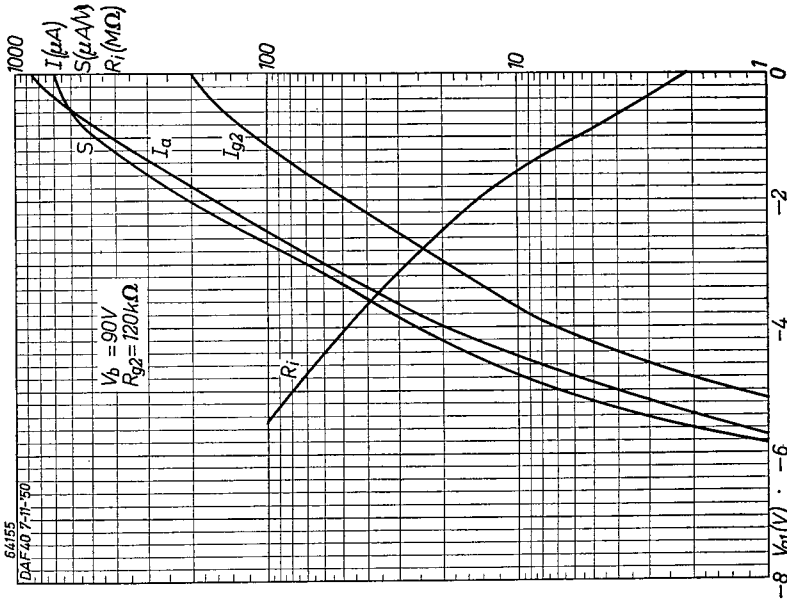

Fig. 6

Anode current (I_a), screen grid current (I_{sg2}), mutual conductance (S) and internal resistance (R_i) as functions of the grid bias (V_{g1}) for an anode and screen grid voltage of 90 V (Fig. 6).

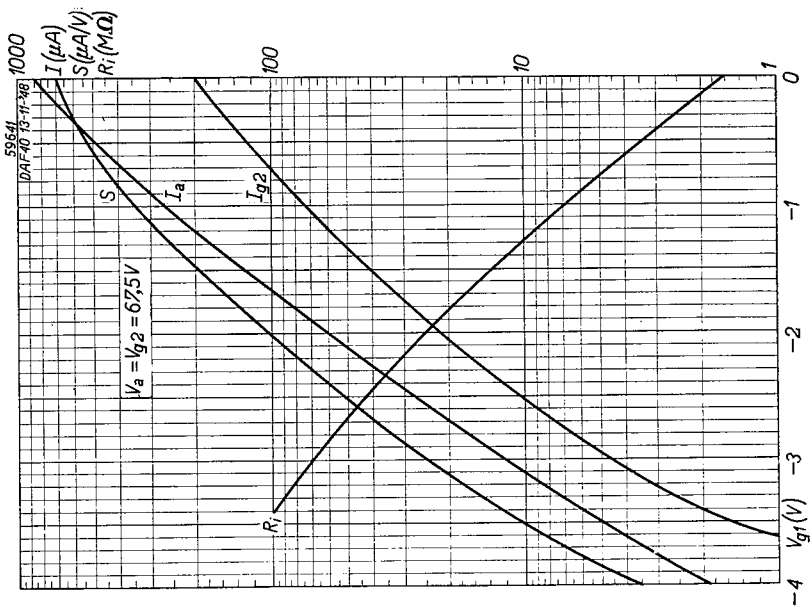

Fig. 5

Anode current (I_a), screen grid current (I_{sg2}), mutual conductance (S) and internal resistance (R_i) as functions of the grid bias (V_{g1}) for an anode and screen grid voltage of 67.5 V (Fig. 5) and for a supply voltage of 90 V (Fig. 6).

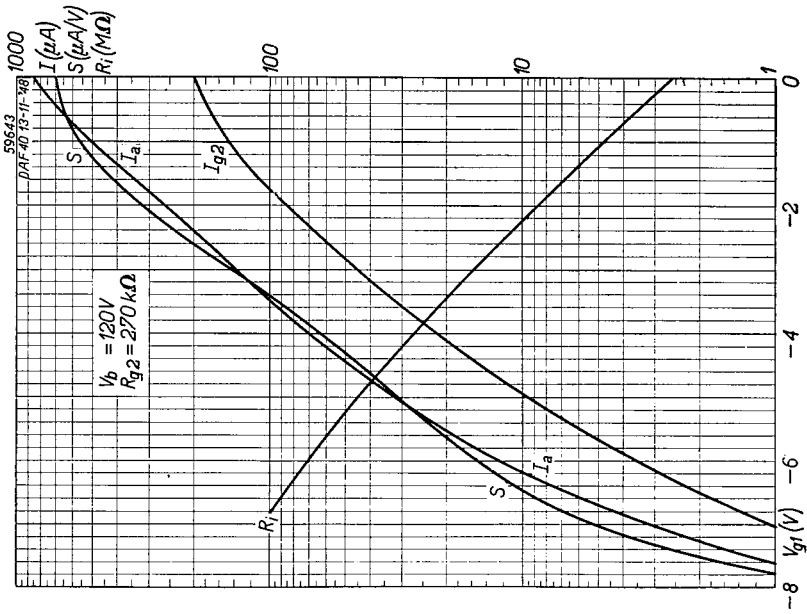

Fig. 7
As Fig. 6, but for a supply voltage of 120 V.

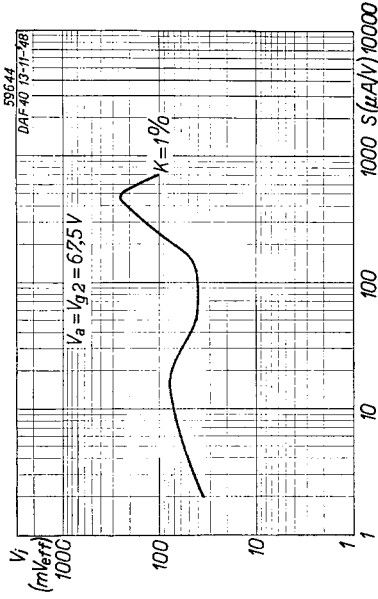

Fig. 8
The voltage (V_i) of an interfering signal at the control grid, producing 1% cross-modulation, as a function of the slope (S). $V_a = V_b = 67.5 V$.

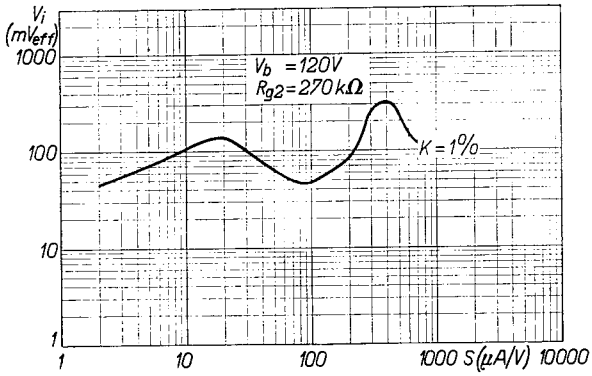

Fig. 9
As Fig. 8, but at $V_b = 120 V$.

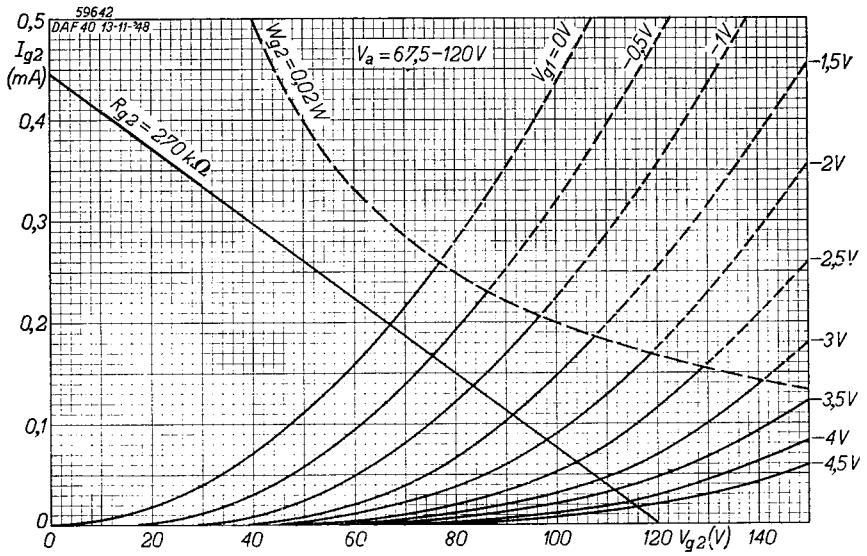

Fig. 10
Screen grid current (I_{g2}) as a function of the screen grid voltage (V_{g2}), with grid bias (V_{g1}) as parameter. The broken curve indicates the maximum screen grid dissipation ($W_{g2} = 0.02 W$). The straight line is the working line with a screen grid resistor $R_{g2} = 270 k\Omega$.

DAF 41 Battery type diode - A.F. pentode

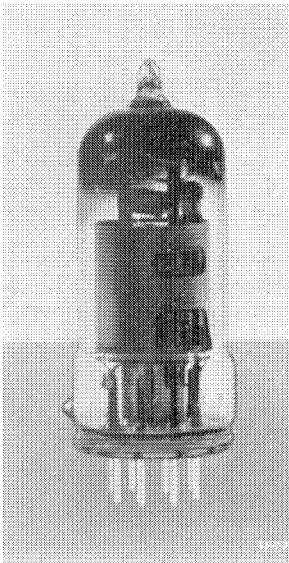

Fig. 1. The DAF 41 (approximately full size).

The DAF 41 is a battery type diode-pentode; the pentode section can be used for A.F. amplification, the diode section for detection or A.G.C. Its filament is identical with that of the DAF 40, and particulars concerning the heating will be found in the description of the latter. Furthermore, since the maximum permissible voltages for the DAF 40 are identical with those of the DAF 41, this valve is suitable for the same types of receivers. From the point of view of microphony, however, the DAF 41 is much better for A.F. amplification purposes than the DAF 40. Under the circumstances described in the chapters dealing with the EAF 42 and EBC 41, special precautions to avoid microphony are not usually necessary, provided that the A.F. input signal is at least 18 mV when the output valve delivers 50 mW. On the other hand, if a higher amplification is required, certain precautions may prove necessary, such as the use of an antimicrophonic valveholder.

TECHNICAL DATA OF THE DIODE-PENTODE DAF 41

Filament data

Heating: direct from battery, rectified A.C., or D.C.; series or parallel feed

In parallel with other valves :

Filament voltage	V_f	=	1.4 V
Filament current	I_f	=	25 mA

In series with other valves :

Filament voltage	V_f	=	1.3 V
------------------	-------	---	-------

DAF 41

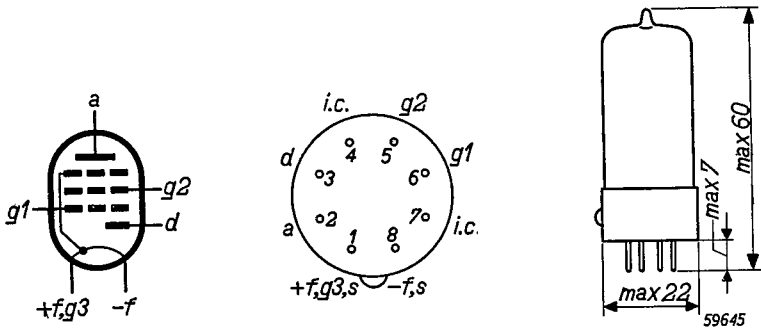

Fig. 2. Electrode arrangement, electrode connections and dimensions in mm of the DAF 41.

Capacitances (valve cold)

Input capacitance	C_{g1}	=	2.8 pF
Output capacitance	C_a	=	3.7 pF
Between anode and control grid	C_{ag1}	<	0.0065 pF
Between diode-anode and cathode	C_d	=	2.1 pF
Between diode-anode and pentode-control grid	C_{gd}	<	0.003 pF
Between diode-anode and pentode-anode	C_{ad}	<	0.1 pF

Operating characteristics of the pentode section used as resistance-coupled A.F. amplifier

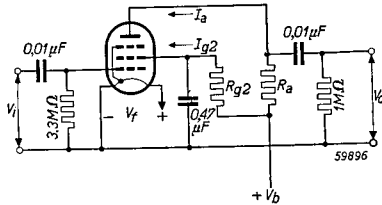

Fig. 3. Circuit diagram showing the DAF 41 used as A.F. amplifier.

V_b (V)	R_a (MΩ)	R_{g2} (MΩ)	I_a (mA)	I_{g2} (mA)	$\frac{V_o}{V_i}$	Distortion (°) with an output voltage (V_o) of		
						$3 V_{RMS}$	$5 V_{RMS}$	$10 V_{RMS}$
67.5	0.22	0.82	0.17	0.04	60	1.4	1.7	
90	0.22	0.82	0.25	0.06	70	0.8	0.9	
90	0.47	2.2	0.13	0.03	83	1.1	1.4	
120	0.47	2.2	0.18	0.04	100	0.5	1.0	
150	0.47	2.2	0.24	0.05	112	0.4	0.7	1.4

Limiting values of the pentode section

Anode voltage, valve biased to cut-off	V_{a_0}	= max.	180 V
Anode voltage	V_a	= max.	135 V
Anode dissipation	W_a	= max.	0.1 W
Screen grid voltage, valve biased to cut-off	V_{g2_0}	= max.	180 V
Screen grid voltage	V_{g2}	= max.	85 V
Screen grid dissipation	W_{g2}	= max.	0.02 W
Grid current starting point	$V_{g1}(I_{g1} = +0.3\mu A)$	= max.	-0.2 V
Cathode current	I_k	= max.	0.5 mA
External resistance between control grid and cathode	R_{g1}	= max.	10 MΩ

Limiting values of the diode section

Peak inverse voltage	$V_{dinv p}$	= max.	100 V
Diode current	I_d	= max.	0.2 mA
Peak diode current	I_{dp}	= max.	1.2 mA

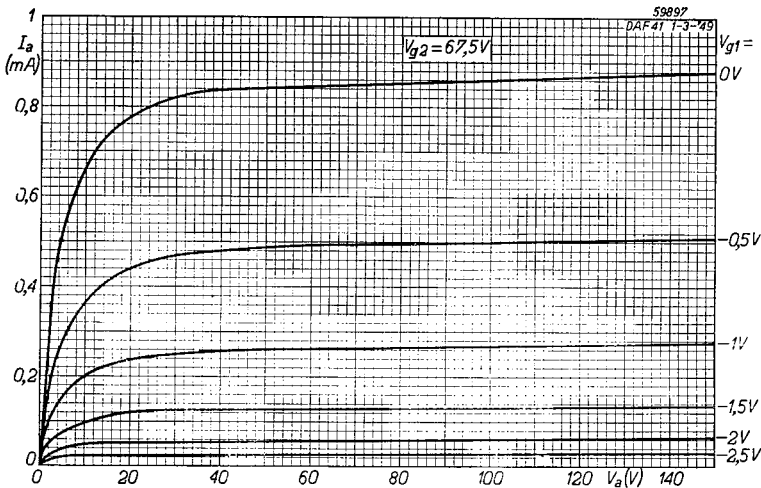

Fig. 4. Anode current (I_a) of the DAF 41 as a function of the anode voltage (V_a) at various values of the grid bias (V_{g1}). Screen grid voltage $V_{g2} = 67.5 V$.

DK 40

DK 40 Battery octode

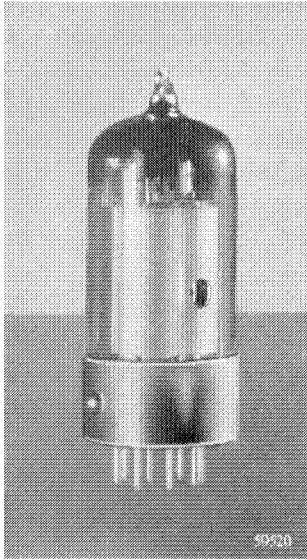

Fig. 1
The battery octode DK 40
(approximately actual size).

The DK 40 is an octode designed for use with a low-tension battery of 1.4 V. The filament current is 50 mA. It can be used in receivers with H.T. batteries of between 67.5 and 135 V, but it is necessary to keep the voltages on the screen grid (grid 5) and the oscillator anode (grid 2) at 67.5 V, to avoid exceeding the maximum permissible dissipation of these electrodes.

When a battery giving more than 67.5 V is employed, grids 2 and 5 can be directly connected to a tapping on the battery or, alternatively, they can be fed separately or together from the full battery voltage through a dropping resistor. The latter arrangement necessitates one or two extra resistors and decoupling capacitors, but it certainly has the advantage that, towards the end of the effective life of the battery, a considerable drop in the battery voltage makes but little difference to the conversion conductance. When grids 2 and 5 are connected directly to the 67.5 battery terminals, the valve will continue to function until the voltage drops to 45 V, but by then the conversion conductance is greatly reduced.

In normal use the DK 40 consumes a total current of about 4 mA, the conversion conductance being about $425 \mu\text{A/V}$. In cases where economy in current consumption is essential, the valve can be incorporated in circuits in which the oscillator anode (grid 2) voltage is 45 V; the total current is then only 2.7 mA, with reasonable conversion conductance, viz. $370 \mu\text{A/V}$. The latter arrangement is not recommended for short-wave work, however. The arrangement of the electrodes in the DK 40 is the same as that in the DK 21, a valve which has given excellent results in use. Taking into account the low anode current, the conversion conductance is high, whilst induction effect and frequency drift are only slight; the characteristics of the valve as an oscillator are quite outstanding.

Briefly, the design is as follows: The second grid takes the form of four rods which serve as the oscillator anode, while the third grid is formed by two more such rods. Due to the absence of positive grid wires in the path of the electrons flowing towards the fourth grid (input grid), they approach it in uniform beams instead of spreading out, and therefore all the electrons reach the fourth grid at roughly the same velocity. With a certain bias applied to this grid, almost all the electrons pass through, whilst a slightly higher bias causes them all to turn back; this means that the slope of the grid is high. Since the conversion conductance of the valve is directly related to

the normal slope of the fourth grid, it follows that the conversion conductance must also be high.

The absence of a screen grid between cathode and fourth grid, moreover, means that the electron stream, repelled by the latter grid, can only proceed to the second grid; the whole of this current is therefore available for oscillation. This is the reason why the oscillatory properties of the valve are good in spite of the low total consumption of current.

Generally speaking, valves designed on the principle of the octode all have the disadvantage of pronounced "induction effect"; this is a capacitive and electronic coupling between the oscillator section of the valve and the

fourth grid, resulting in a voltage at oscillator frequency on the fourth grid, and thus across the input circuit.

This induced voltage not only affects the proper functioning of the valve — resulting in a reduction of the conversion conductance — but also increases the frequency drift. Furthermore, the coupling between the input circuit and the aerial may result in radiation and consequent interference with neighbouring receivers.

All these things are to be avoided as much as possible, and in the

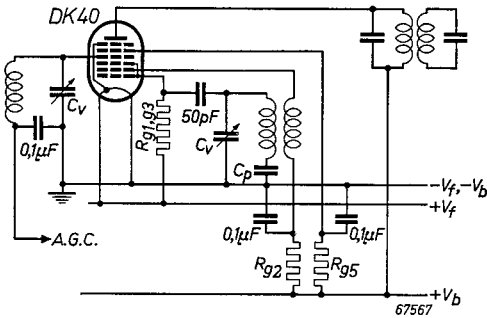

Fig. 2
The DK 40 employed as a frequency changer.

DK 40 this is effected by the third grid. The latter is connected to the oscillator grid (grid 1) and therefore carries the oscillator voltage; now the geometry of the electrodes is such that the capacitive coupling between grids 3 and 4 largely counteracts the "induction effect". In this way the unpleasant consequences of the "induction effect" are avoided, whilst the influence of the third grid on the general performance of the valve is negligible, since the two rods of which this "grid" consists are located in the electronic "shadow" of the supports of grid 1.

To ensure satisfactory performance of the oscillator section of the valve, the following points should be taken into consideration:

- 1) The tuned circuit should be connected to grid 1.
- 2) If a voltage dropping resistor is to be included in the oscillator anode circuit (grid 2), this must be in series with the coupling coil (i.e. not parallel-fed).
- 3) The grid leak in the oscillator circuit should be connected between this grid and L.T. positive (contact 1 of the valveholder).
- 4) For the oscillator grid leak 35 kΩ is the most suitable value, with a capacitor of 50 pF; this will ensure satisfactory working of the oscillator section of the valve in the normal broadcast bands. Higher values than those suggested may involve some risk of squegging at the short-wave ends of the bands, whereas lower values merely make the oscillator performance less satisfactory.

DK 40

As the DK 40 was designed for use in high-performance receivers of the more expensive type too, everything possible has been done to fulfil this object. Microphony, for instance, has been made the subject of special investigation. In this respect the DK 40 shows a considerable improvement over earlier battery types of frequency changers, and it can safely be used in receivers intended for high output.

In connection with electrical measurements on frequency changers for battery operation, the following may be of interest. One of the factors determining the characteristics of any frequency changer is, quite naturally, the value of the oscillator voltage, which can be measured by means of a valve-voltmeter; alternatively, the current through the oscillator grid resistor can be taken as a measure of the oscillator voltage. The advantage of the latter method is that a direct current is measured instead of an alternating R.F. voltage, so that a simple meter will serve the purpose without affecting the working of the oscillator in any way. This cannot be said of a valve-voltmeter, whose damping and input capacitance always tend to modify the oscillator voltage and frequency.

In the case of battery frequency changers, however, measurement of the direct current also raises a difficulty; if a number of valves of the same type be made to operate on the same oscillator voltage, the individual grid current values will be found to exhibit a certain amount of spread, caused by differences in the contact potential between the oscillator grid and the filament among the various specimens thus tested. Apart from grid current, this variation in contact potential has no effect on the performance of the valve, but if the grid current is taken as a measure of the oscillator voltage for the purpose of deciding upon the operating point of the valve, the voltage may be found to vary considerably between one sample and another, and these differences will certainly affect the performance of the valve.

For accurate measurements on battery-operated frequency changers, therefore, it is advisable to determine the oscillator voltage by one of the following methods.

- a) Construct a calibration curve for the valve to be measured, plotting the values of the direct current flowing in the oscillator grid circuit as a function of the oscillator voltage, as measured with a valve-voltmeter. The voltmeter is then disconnected, after which the oscillator voltage can be determined from the D.C. grid current and the curve, for every measurement.
- b) Apply a variable bias in series with the grid leak (between grid leak and filament), using a low-resistance potentiometer with decoupling capacitor and battery. The potentiometer should be so adjusted that, for a given oscillator voltage (measured with a valve-voltmeter) the D.C. grid current reaches a value that can be read from the curves in Figs. 14 to 18 (say $140 \mu\text{A}$ at an oscillator voltage of $8 V_{RMS}$). When the voltmeter is disconnected, the oscillator voltage can then be ascertained from the grid current with the aid of the curves.

The latter method amounts to this, that the contact potential between grid 1 and filament is so far compensated by the applied grid bias that the result-

ant voltage between grid and filament reaches a certain value; at this value, which is the mean value of the contact potential, the curves I_{g1+g3} are then plotted as a function of the oscillator voltage (see Figs. 14 to 18).

TECHNICAL DATA OF THE BATTERY OCTODE DK 40

Filament data

Heating: direct, from battery, rectified A.C. or D.C.: series or parallel feed

In parallel with other valves:

Filament voltage	V_f	=	1.4 V
Filament current	I_f	=	50 mA

In series with other valves:

Filament voltage	V_f	=	1.3 V
----------------------------	-------	---	-------

Capacitances (measured on the cold valve)

Input capacitance	C_{g1}	=	6.9 pF
Output capacitance	C_a	=	9.6 pF
Between anode and control grid	C_{ag1}	<	0.16 pF
Input capacitance, oscillator section	C_{g1+g3}	=	5.6 pF
Output capacitance, oscillator section	C_{g2}	=	5.0 pF
Between oscillator anode and input grid	C_{g2g1}	=	0.9 pF
Between oscillator grid and input grid	$C_{(g1+g3)g1}$	=	1.1 pF

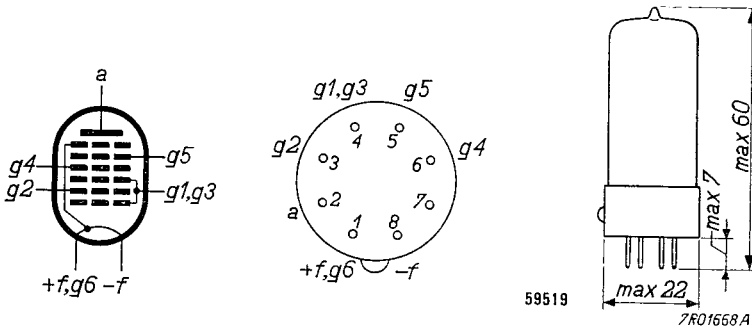

Fig. 3
Electrode arrangement, electrode connections and maximum dimensions in mm of the DK 40.

DK 40

Operating characteristics

Anode and supply voltage	$V_a = V_b =$	67.5	90	V
Series resistor, grid 5	$R_{g5} =$	0	90	k Ω
Series resistor, grid 2	$R_{g2} =$	0	8.5	k Ω
Oscillator grid leak	$R_{g1+g3} =$	35	35	k Ω
Oscillator voltage	$V_{osc} =$	8	8	V_{RMS}
Grid bias	$V_{g4} =$	0—9.5		0—12.5 V
Voltage, grid 5	$V_{g5} =$	67.5	67.5	67.5 90 V
Voltage, grid 2	$V_{g2} =$	67.5	—	67.5 — V
Anode current	$I_a =$	1.0	—	1.0 — mA
Current, grid 5	$I_{g5} =$	0.25	—	0.25 — mA
Current, grid 2	$I_{g2} =$	2.6	—	2.6 — mA
Conversion conductance	$S_c =$	425	4.25	425 4.25 $\mu A/V$
Internal resistance	$R_i =$	0.9	>10	>10 M Ω
Equivalent noise resistance	$R_{eq} =$	67	—	67 — k Ω

Anode and supply voltage	$V_a = V_b =$	120	135	V
Series resistor, grid 5	$R_{g5} =$	210	270	k Ω
Series resistor, grid 2	$R_{g2} =$	20	26	k Ω
Oscillator grid leak	$R_{g1+g3} =$	35	35	k Ω
Oscillator voltage	$V_{osc} =$	8	8	V_{RMS}
Grid bias	$V_{g4} =$	0—16.5		0—18.5 V
Voltage, grid 5	$V_{g5} =$	67.5	120	67.5 135 V
Voltage, grid 2	$V_{g2} =$	67.5	—	67.5 — V
Anode current	$I_a =$	1.0	—	1.0 — mA
Current, grid 5	$I_{g5} =$	0.25	—	0.25 — mA
Current, grid 2	$I_{g2} =$	2.6	—	2.6 — mA
Conversion conductance	$S_c =$	425	4.25	425 4.25 $\mu A/V$
Internal resistance	$R_i =$	1.0	>10	1.0 >10 M Ω

Valve used in economy circuit (not suitable for S.W.)

Anode and supply voltage	$V_a = V_b$	=	67.5	V
Series resistor, grid 5	R_{g5}	=	0	Ω
Series resistor, grid 2	R_{g2}	=	15	k Ω
Oscillator grid leak	R_{g1+g3}	=	35	k Ω
Oscillator voltage	V_{osc}	=	8	V_{RMS}
Grid bias	V_{g4}	=	0—9.5 V	
Voltage, grid 5	V_{g5}	=	67.5	67.5 V
Voltage, grid 2	V_{g2}	=	45	— V
Anode current	I_a	=	0.85	— mA
Current, grid 5	I_{g5}	=	0.19	— mA
Current, grid 2	I_{g2}	=	1.5	— mA
Conversion conductance	S_c	=	370	3.7 $\mu A/V$
Internal resistance	R_i	=	1.0	>10 M Ω

Typical characteristics of the oscillator section (filament, 1st grid and 2nd grid; g_1 and g_3 connected to +f)

Anode voltage	V_a	= 67.5	67.5 V
Screen grid voltage	V_{g5}	= 67.5	67.5 V
Grid bias	V_{g4}	= 0	0 V
Oscillator anode voltage	V_{g2}	= 67.5	45 V
Oscillator anode current	I_{g2}	= 2.9	1.3 mA
Slope of osc. anode with respect to osc. grid	S_{g2g1}	= 1.2	0.9 mA/V
Amplification factor of osc. anode with respect to osc. grid	μ_{g2g1}	= 14	14

Limiting values

Anode voltage	V_a	= max.	135 V
Anode dissipation	W_a	= max.	0.2 W
Screen grid voltage	V_{g5}	= max.	135 V
Screen grid dissipation	W_{g5}	= max.	0.02 W
Oscillator anode voltage	V_{g2}	= max.	100 V
Osc. anode dissipation	W_{g2}	= max.	0.2 W
Cathode current	I_k	= max.	5 mA
Grid current starting point	$V_{g4}(I_{g4} = +0.3\mu\text{A})$	= max.	-0.2 V
External resistance between con- trol grid and filament	R_{g4}	= max.	3 M Ω
Oscillator grid leak	R_{g1+g3}	= max.	35 k Ω

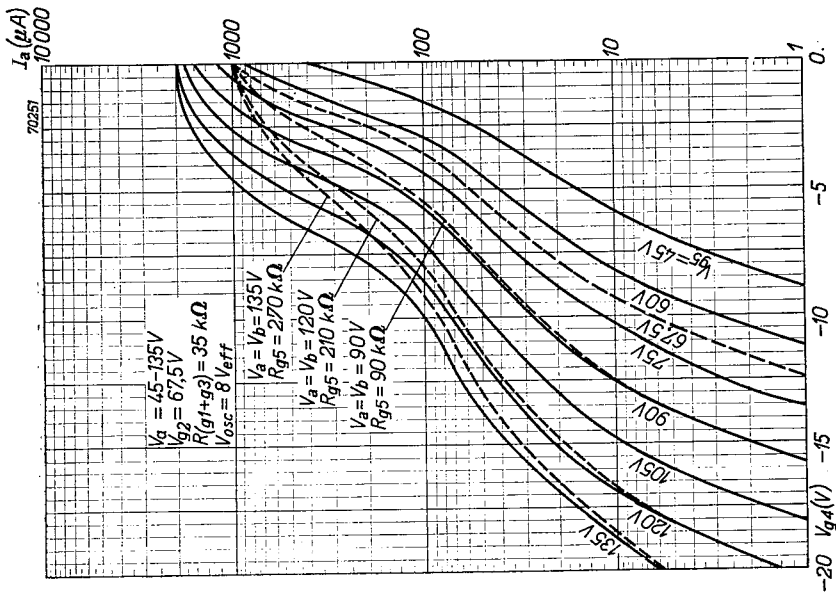

Fig. 4

Anode current (I_a , Fig. 4) and conversion conductance (S_c , Fig. 5) of the DK 40 as functions of the grid bias (V_{g4}), at different battery voltages. The broken curves indicate the anode current and conversion conductance with different resistors in the screen grid lead (grid 5). Measurements taken on an oscillating valve, in the circuit shown in Fig. 2.

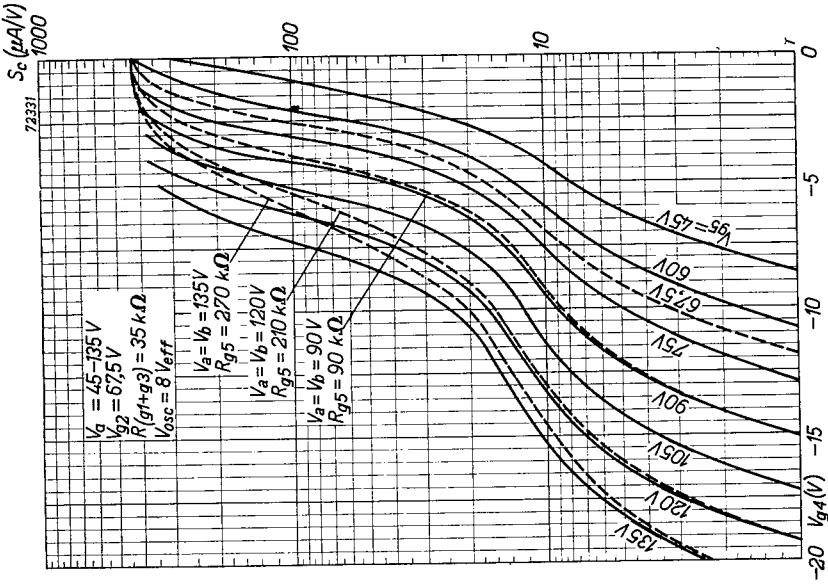

Fig. 5

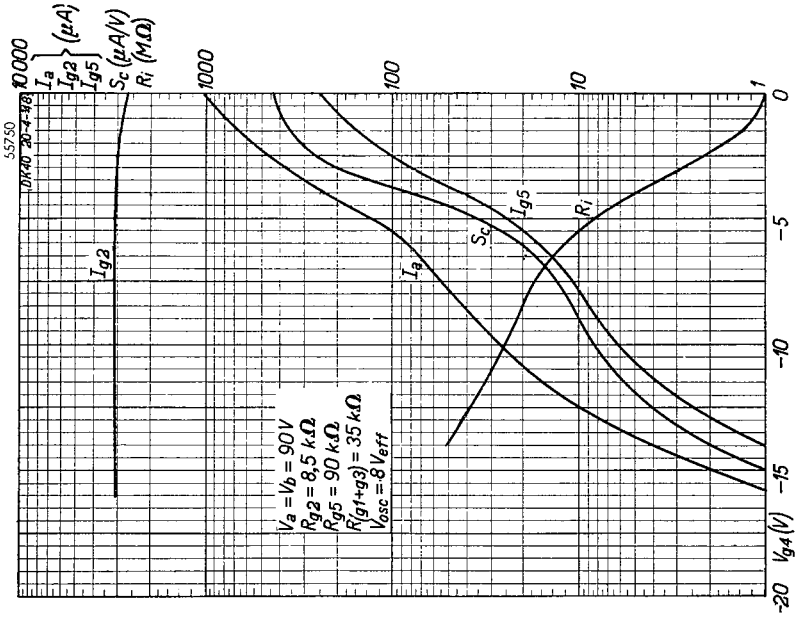

Fig. 7

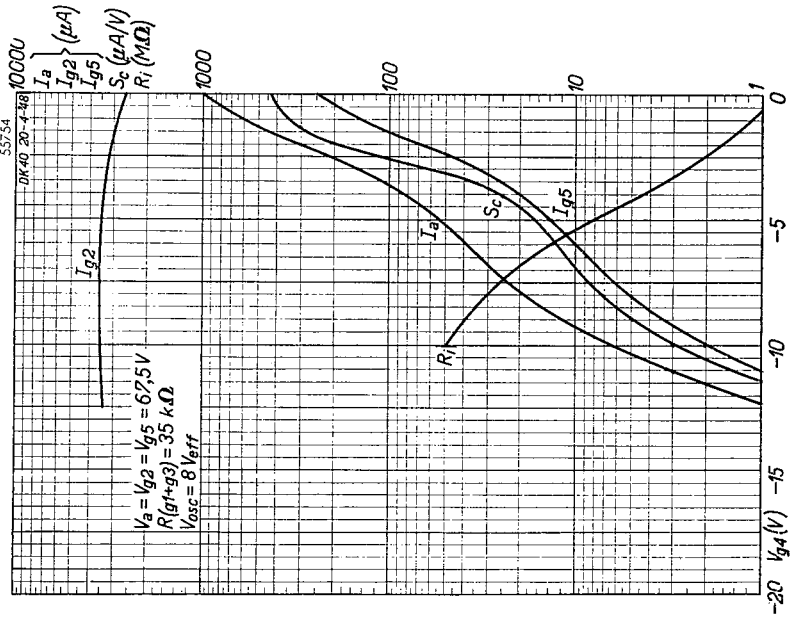

Fig. 6

Anode current (I_a), screen grid current (I_{gs}), oscillator anode current (I_{gs}), conversion conductance (S_c) and internal resistance (R_i) of the DK 40 as functions of the grid bias (V_{g4}). Measurements taken on an oscillating valve, in the circuit shown in Fig. 2. Fig. 6: battery voltage 67.5 V; Fig. 7: battery voltage 90 V.

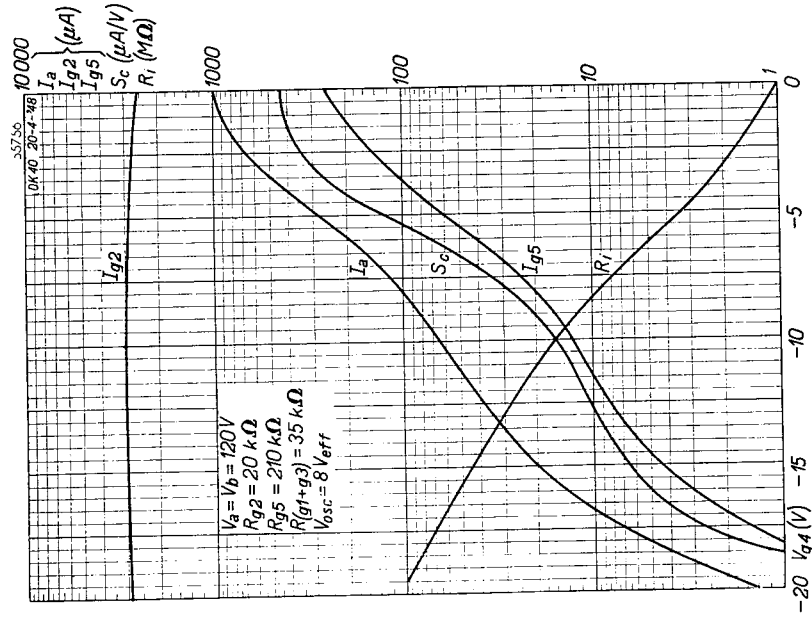

Fig. 8
As Fig. 6, but for battery voltages 120 V (Fig. 8) and 135 V (Fig. 9).

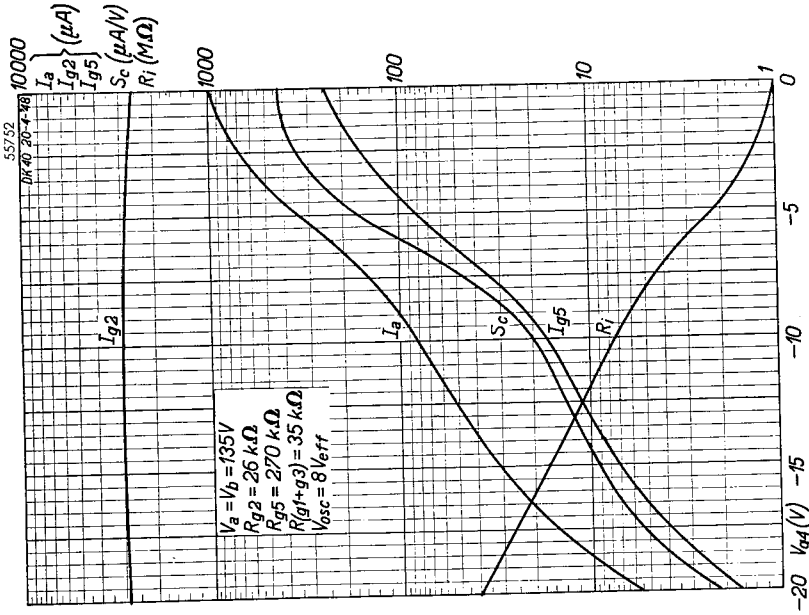

Fig. 9

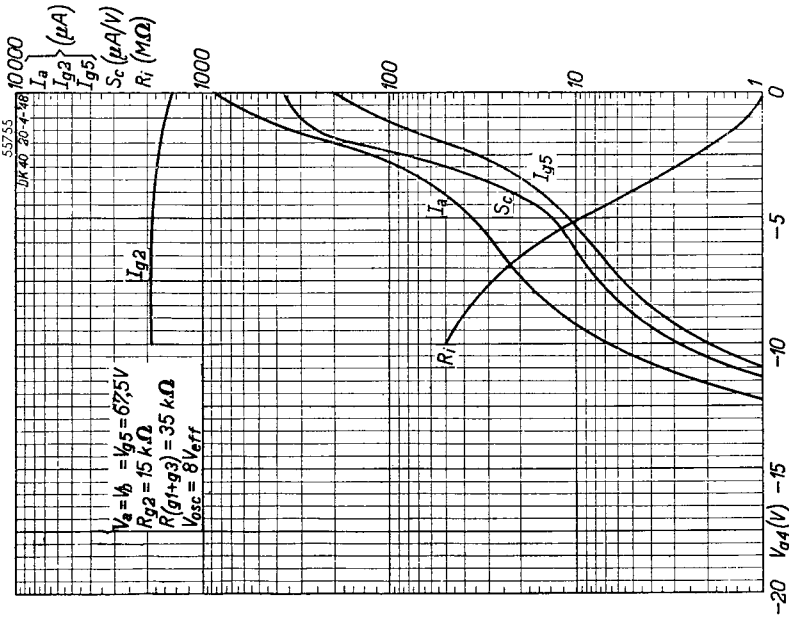

Fig. 10

As Fig. 6, but for the economy circuit (oscillator anode voltage $V_{g4} = 45 \text{ V}$).

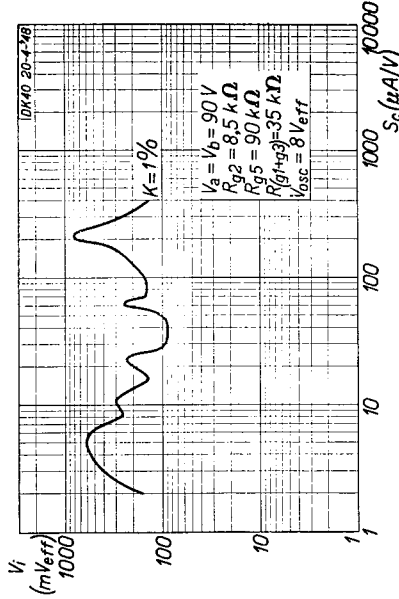
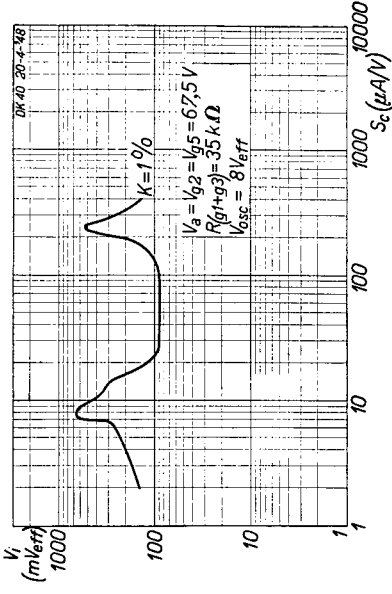

Fig. 11

Effective voltage (V_i) of an interfering signal on the control grid, producing 1% cross modulation, as a function of the conversion conductance (S_c). Upper Fig.: battery voltage 67.5 V; lower Fig.: battery voltage 90 V.

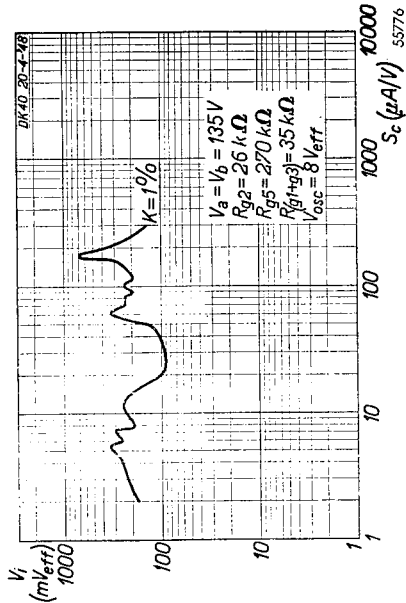
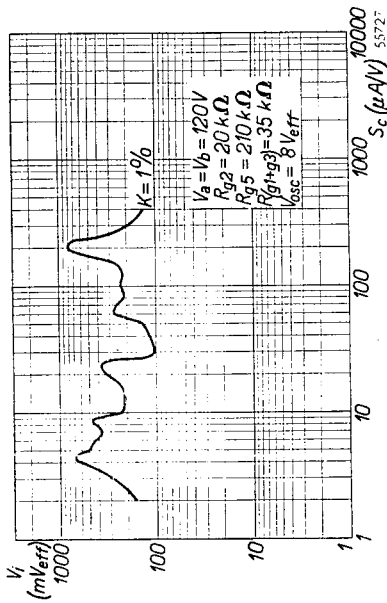

Fig. 12

As Fig. 11: upper Fig.: battery voltage 120 V;
lower Fig.: battery voltage 135 V.

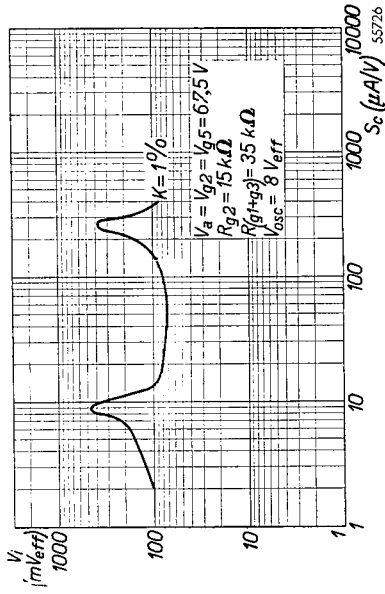

Fig. 13

As Fig. 11, but for the economy circuit
(oscillator anode voltage $V_g = 45$ V).

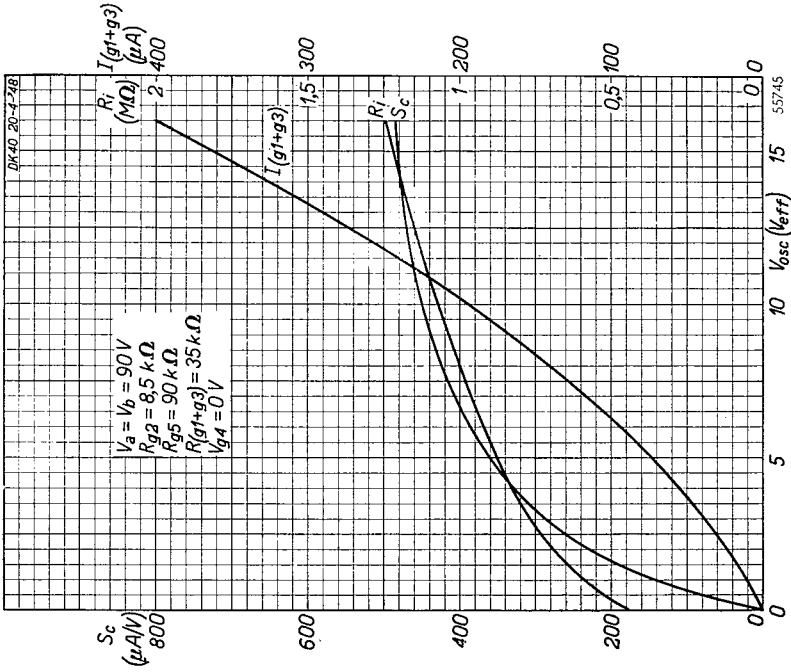

Fig. 14

(conversion conductance (S_c), internal resistance (R_i) and oscillator current (I_{g1+g3}) as functions of the oscillator voltage (V_{osc}). Fig. 14; battery voltage 67.5 V. Fig. 15; battery voltage 90 V.

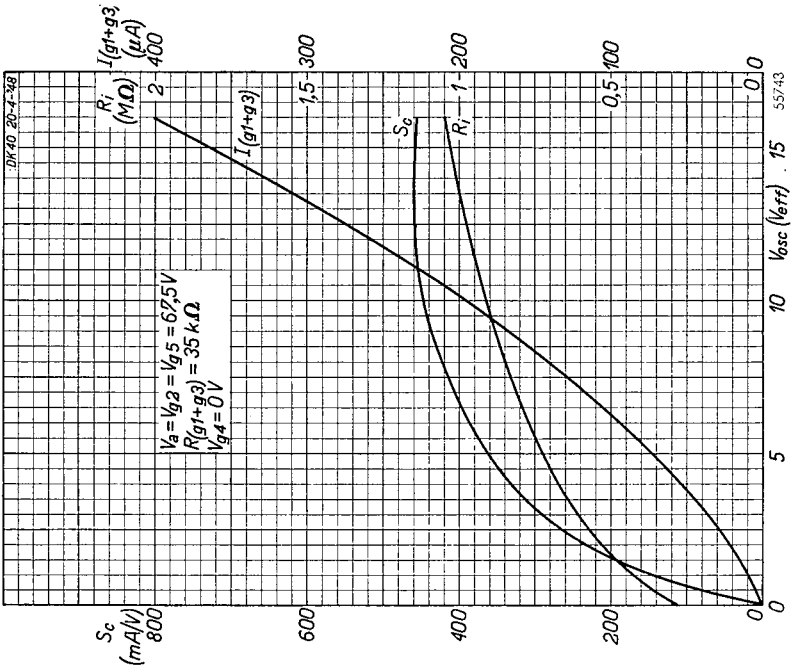

Fig. 15

(conversion conductance (S_c), internal resistance (R_i) and oscillator current (I_{g1+g3}) as functions of the oscillator voltage (V_{osc}). Fig. 14; battery voltage 67.5 V. Fig. 15; battery voltage 90 V.

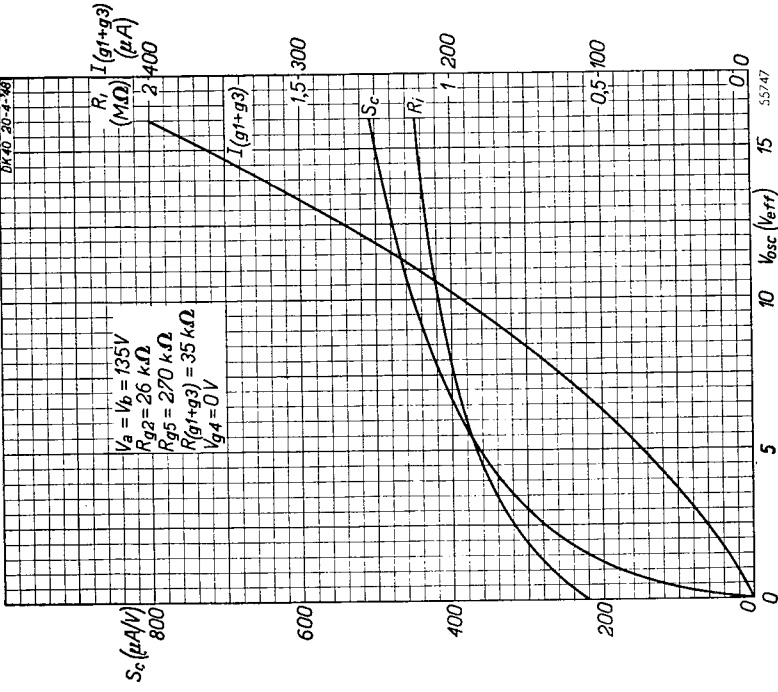

Fig. 17
 As Fig. 14, but with 135 V battery.

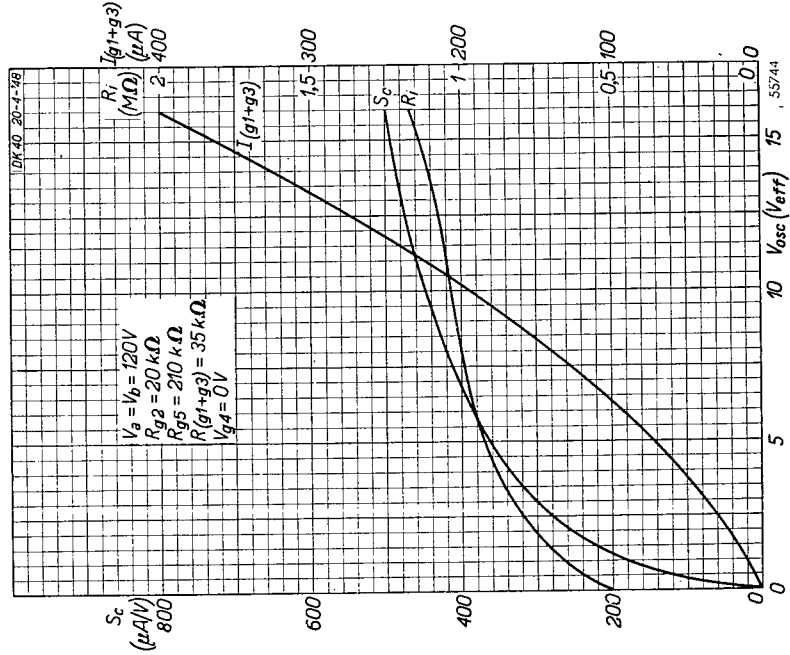

Fig. 16
 As Fig. 14, but with 120 V battery.

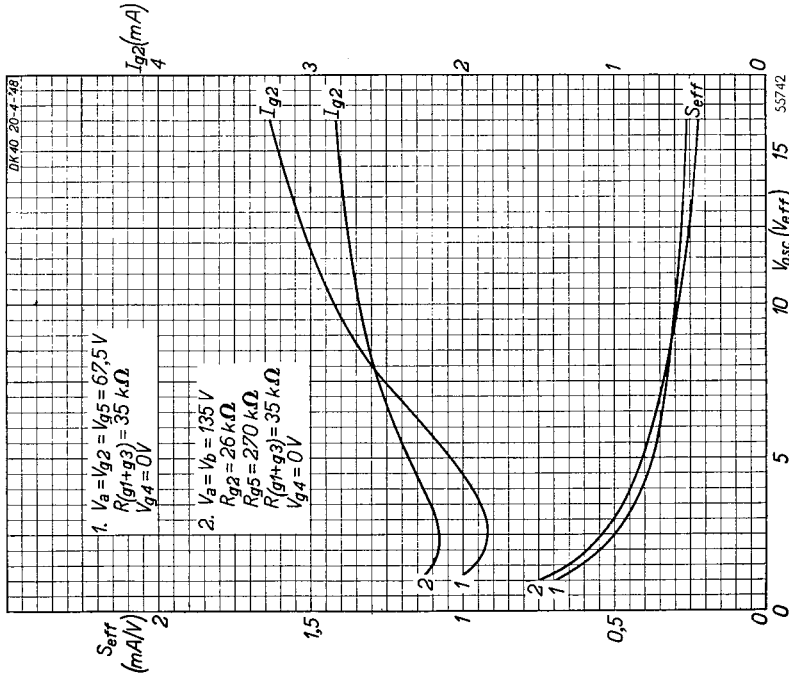

Fig. 19

Effective slope (S_{eff}) of the oscillator section (filament and grids 1 and 2) and oscillator anode current (I_{g2}) as functions of the oscillator voltage (V_{osc}), for battery voltages of 67.5 and 135 V.

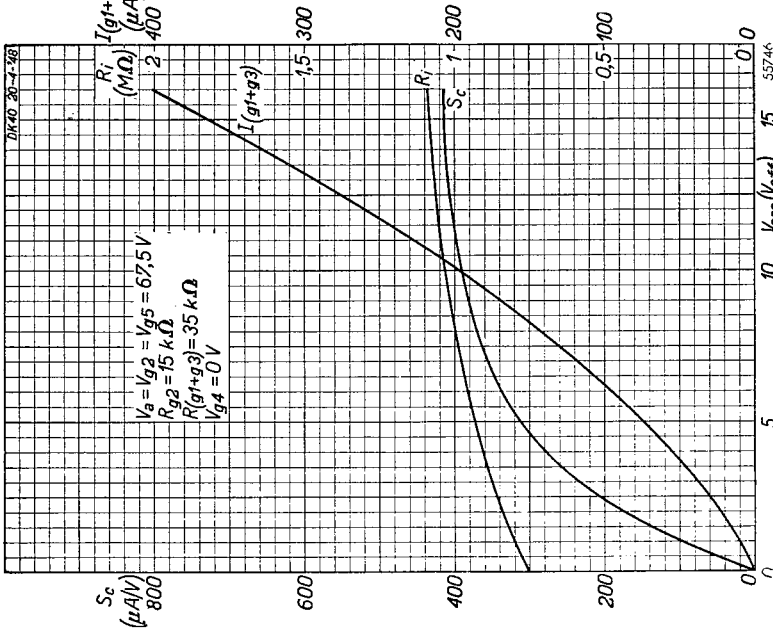

Fig. 18

As Fig. 14, but for the economy circuit (oscillator anode voltage $V_{g2} = 45 \text{ V}$).

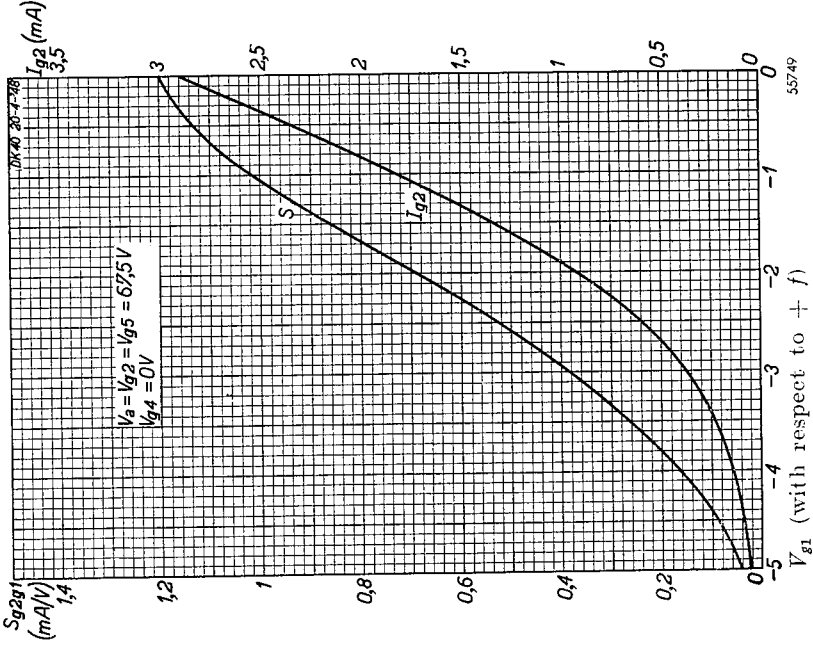

Fig. 21
 Static slope (S_{gg1}) of the oscillator section (filament and grids 1 and 2), and oscillator anode current (I_{g2}) as functions of the bias on the first grid, at a battery voltage of 67.5 V.

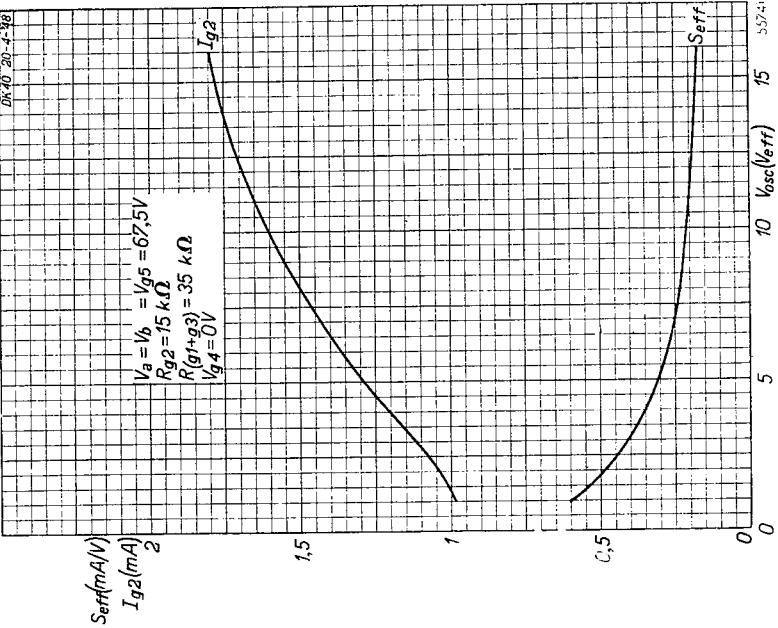

Fig. 20
 As Fig. 19, but for the economy circuit (oscillator anode voltage $V_{g2} = 45$ V).

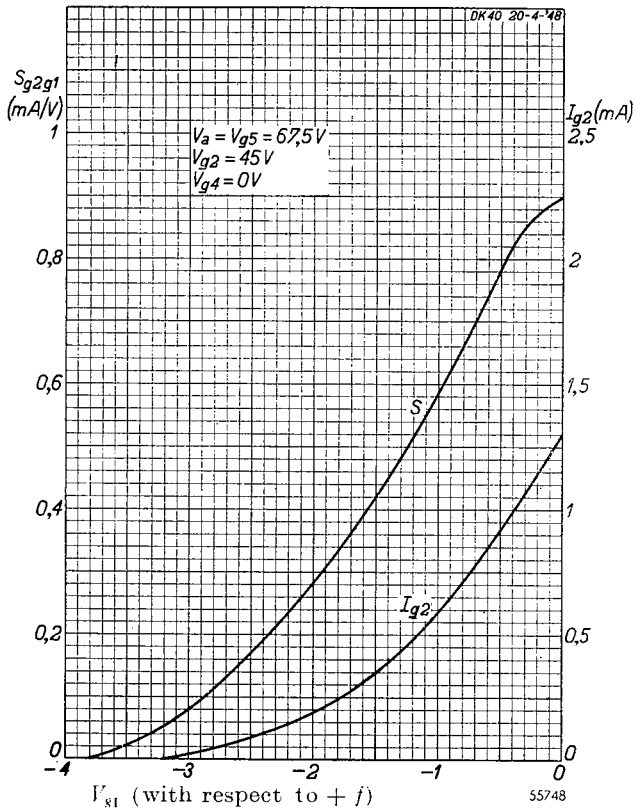

Fig. 22
 As Fig. 21, but employing the economy circuit
 (oscillator anode voltage $V_{g2} = 45$ V).

DL 41 Battery output pentode

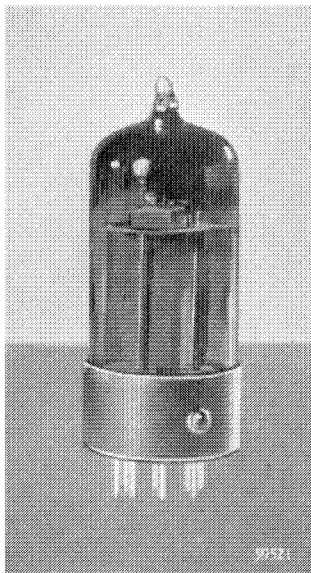

Fig. 1
The battery output pentode DL 41 (approximately actual size).

The DL 41 is a directly heated output valve intended for use in receivers working on fairly high H.T. voltages (90-150 V). For sets operating on lower voltages the DL 92 is the better valve. The output of the DL 41 is about 360 mW at 90 V, or approximately 600 mW at 120 V, but two of these valves in Class B output will yield almost 2 W at an anode voltage of 150 V, or nearly as much as the output of a mains receiver.

Consequently, the DL 41 is a very useful valve for the type of battery set that is expected to give a performance equal to that of a mains receiver in districts where no electrical mains supplies exist; in particular, this would include sets operated by vibrators fed from an accumulator and, also, the type that can be switched for use on either batteries or mains (so-called "ABC" sets). The use of Class B amplification in these cases assures a relatively low consumption of current.

The filament of the DL 41 is made in two V-shaped sections which can be connected either in series or in parallel; when connected in parallel the filament takes 100 mA at 1.4 V,

whilst in the series arrangement the current is 50 mA at 2.8 V. In the latter case the valve can be used with its filament connected in series with those of other battery valves. (See, however, the Introduction on page 270.)

For use in low-consumption receivers it is sufficient to employ only one of the filament sections, in which case the current consumed is 50 mA at 1.4 V. With an anode voltage of 90 V this will give an output of roughly 180 mW, the anode current being only 4 mA.

If the valve is to be operated in conjunction with a switch to run either normally or with reduced current consumption, it should be remembered that the optimum load differs considerably in these two cases: when the filament connections are switched over, the load resistance should be simultaneously changed.

Generally speaking, when two of these valves are used in Class B, in a set driven not direct from batteries, but from a vibrator or rectifier, the positive voltages will increase as a result of the smaller current taken when there is no signal on the input of the receiver. A voltage of up to 180 V is permissible in these circumstances and involves no risk of damage to the valve, but, when the receiver is delivering its maximum output, the anode and screen potentials must not exceed 150 V.

In view of the high output of the DL 41, special care has been taken in the

design of the valve to avoid microphony; many features have been incorporated to suppress this trouble and no difficulties should be experienced from this cause.

TECHNICAL DATA OF THE BATTERY OUTPUT PENTODE DL 41

Filament data

Heating: direct, from battery, rectified A.C., or D.C.; series or parallel feed

A. *Filament connections 1 and 8* (one section of the filament)

In parallel with other valves :

Filament voltage	V_f	=	1.4 V
Filament current	I_f	=	50 mA

In series with other valves :

Filament voltage	V_f	=	1.3 V
----------------------------	-------	---	-------

B. *Filament connections 1 and 7+8* (two sections in parallel)

In parallel with other valves :

Filament voltage	V_f	=	1.4 V
Filament current	I_f	=	100 mA

C. *Filament connections 7 and 8* (the two sections in series)

In parallel with other valves :

Filament voltage	V_f	=	2.8 V
Filament current	I_f	=	50 mA

In series with other valves :

Filament voltage	V_f	=	2.6 V
----------------------------	-------	---	-------

Capacitances (measured on the cold valve)

Input capacitance	C_{g1}	=	4.7 pF
Output capacitance	C_a	=	5.3 pF
Between anode and control grid	C_{ag1}	<	0.5 pF

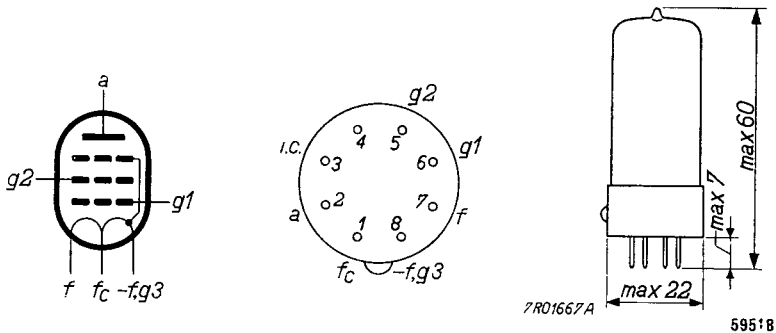

Fig. 2
Electrode arrangement, electrode connections and maximum dimensions in mm of the DL 41.

DL 41

Single valve used for Class A operation (economy circuit, filament connections 1 and 8, $V_f=1.4$ V, $I_f=50$ mA)

Anode voltage	V_a	=	90	120	V
Screen grid voltage	V_{g2}	=	90	120	V
Grid bias	V_{g1}	=	-3.6	-5.8	V
Anode current	I_a	=	4	5	mA
Screen grid current	I_{g2}	=	0.65	0.82	mA
Mutual conductance	S	=	1.25	1.35	mA/V
Amplification factor, grid 2 with respect to grid 1	μ_{g2g1}	=	10	10	
Internal resistance	R_i	=	175	165	k Ω
Optimum load	R_a	=	22.5	24	k Ω
Output with 10% distortion	$W_o(d=10\%)$	=	160	270	mW
Alternating input voltage for 10% distortion	$V_i(d=10\%)$	=	3	3.5	V_{RMS}
Output at grid current starting point	$W_o(I_{g1}=+0.3\mu A)$	=	180	300	mW
Sensitivity	$V_i(W_o=50mW)$	=	1.4	1.3	V_{RMS}

Single valve used for Class A operation (filament connections 1 and 7+8, $V_f=1.4$ V, $I_f=100$ mA)

Anode voltage	V_a	=	90	120	V
Screen grid voltage	V_{g2}	=	90	120	V
Grid bias	V_{g1}	=	-3.6	-5.65	V
Anode current	I_a	=	8	10	mA
Screen grid current	I_{g2}	=	1.3	1.65	mA
Mutual conductance	S	=	2.45	2.55	mA/V
Amplification factor, grid 2 with respect to grid 1	μ_{g2g1}	=	10	10	
Internal resistance	R_i	=	90	80	k Ω
Optimum load	R_a	=	11.3	12	k Ω
Output with 10% distortion	$W_o(d=10\%)$	=	330	550	mW
Alternating input voltage for 10% distortion	$V_i(d=10\%)$	=	3.1	3.8	V_{RMS}
Output at grid current starting point	$W_o(I_{g1}=+0.3\mu A)$	=	360	600	mW
Sensitivity	$V_i(W_o=50mW)$	=	1.05	0.9	V_{RMS}

Single valve Class A operation (filament connections 7 and 8, $V_f=2.8$ V, $I_f=50$ mA)

Anode voltage	V_a	=	90	120	V
Screen grid voltage	V_{g2}	=	90	120	V
Grid bias	V_{g1}	=	-3.6	-5.45	V
Anode current	I_a	=	6	9	mA
Screen grid current	I_{g2}	=	0.95	1.45	mA
Mutual conductance	S	=	2.2	2.45	mA/V
Internal resistance	R_i	=	100	95	k Ω
Optimum load	R_a	=	15	13.5	k Ω
Output with 10% distortion	$W_o(d=10\%)$	=	235	490	mW
Alternating input voltage for 10% distortion	$V_i(d=10\%)$	=	2.6	3.5	V_{RMS}
Output at grid current starting point	$W_o(I_{g1}=+0.3\mu A)$	=	270	540	mW
Sensitivity	$V_i(W_o=50$ mW)	=	1.0	0.9	V_{RMS}

Two valves in Class B push-pull operation (filament connections 1 and 7+8, $V_f=1.4$ V, $I_f=100$ mA)

Anode voltage	V_a	=	90	V	
Screen grid voltage	V_{g2}	=	90	V	
Grid bias	V_{g1}	=	-7	V	
Optimum load	R_{aa}	=	20	k Ω	
Alternating input voltage	V_i	=	0	5.5	V_{RMS}
Anode current	I_a	=	2×1.5	2×5.6	mA
Screen grid current	I_{g2}	=	2×0.25	2×2.0	mA
Output power	W_o	=	0	560	mW
Distortion	d	=	—	6	%
Anode voltage	V_a	=	150 ¹⁾	V	
Screen grid voltage	V_{g2}	=	150 ¹⁾	V	
Grid bias	V_{g1}	=	-13.2	V	
Optimum load	R_{aa}	=	15	k Ω	
Alternating input voltage	V_i	=	0	10.6	V_{RMS}
Anode current	I_a	=	2×1.5	2×11.5	mA
Screen grid current	I_{g2}	=	2×0.25	2×4	mA
Output power	W_o	=	0	2100	mW
Distortion	d	=	—	5	%

¹⁾ Without input signal V_a and V_{g2} may rise to max. 180 . . .

DL 41

Two valves in Class B push-pull operation (filament connections 7 and 8, $V_f=2.8$ V, $I_f=50$ mA)

Anode voltage	V_a	=	150 ¹⁾	V
Screen grid voltage	V_{g2}	=	150 ¹⁾	V
Grid bias	V_{g1}	=	-12.6	V
Optimum load	R_{aa}	=	15	k Ω
Alternating grid voltage	V_i	=	0	10 V_{RMS}
Anode current	I_a	=	2×1.5	2×11 mA
Screen grid current	I_{g2}	=	2×0.25	2×3.3 mA
Output power	W_o	=	0	1850 mW
Distortion	d	=	—	3.5 %

Limiting values

Anode voltage	V_a	= max.	150 V ¹⁾
Anode dissipation	W_a	= max.	1.2 W
Screen grid voltage	V_{g2}	= max.	150 V ¹⁾
Screen grid dissipation without input signal	$W_{g2}(V_i=0)$	= max.	0.3 W
Screen grid dissipation at maximum output	$W_{g2}(W_o=\max)$	= max.	0.6 W
Grid current starting point	$V_{g1}(I_{g1}=+0.3\mu A)$	= max.	-0.2 V
Cathode current (filament connections 1 and 8)	$I_k(V_f=1.4$ V, $I_f=50$ mA)	= max.	7 mA
Cathode current (filament connections 1 and 7+8)	$I_k(V_f=1.4$ V, $I_f=100$ mA)	= max.	16 mA
Cathode current (filament connections 7 and 8)	$I_k(V_f=2.8$ V, $I_f=50$ mA)	= max.	16 mA
External resistance between control grid and filament	R_{g1}	= max.	2 M Ω

¹⁾ Without input signal V_a and V_{g2} may rise to max. 180 V.

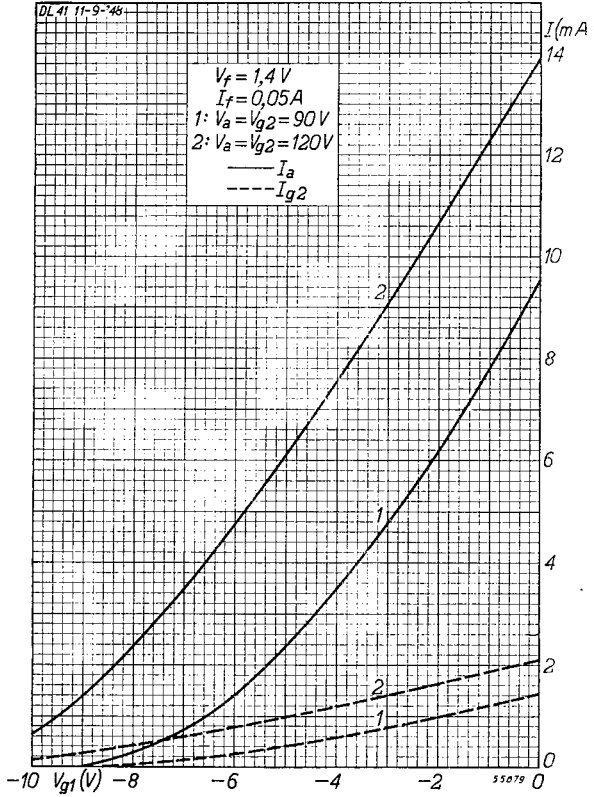

Fig. 3
 Anode current (I_a) and screen grid current (I_{g2}) of the DL 41 as functions of the grid bias (V_{g1}), for battery voltages of 90 and 120 V. Filament connections 1 and 8 ($V_f = 1.4 V$, $I_f = 50 mA$).

DL 41

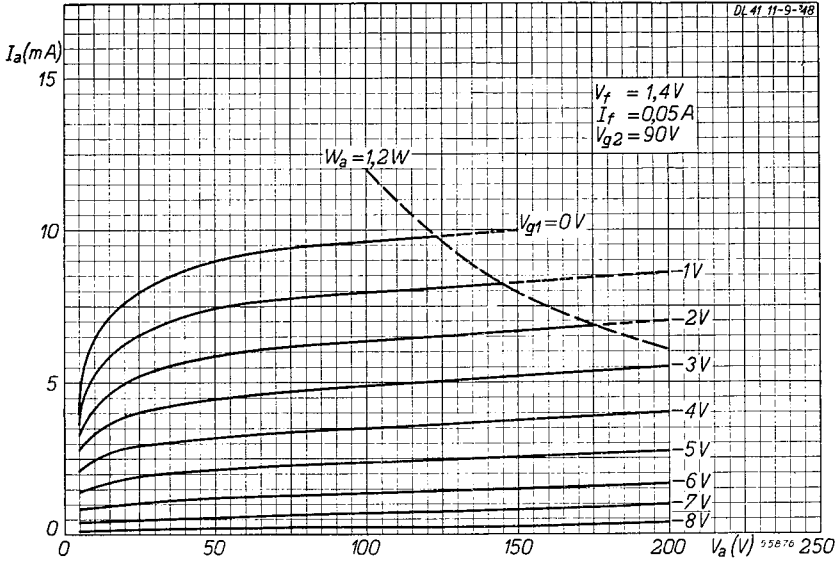

Fig. 4
 I_a/V_a characteristics of the DL 41 for a screen grid voltage of 90 V. Filament connections 1 and 8 ($V_f=1.4$ V, $I_f=50$ mA).

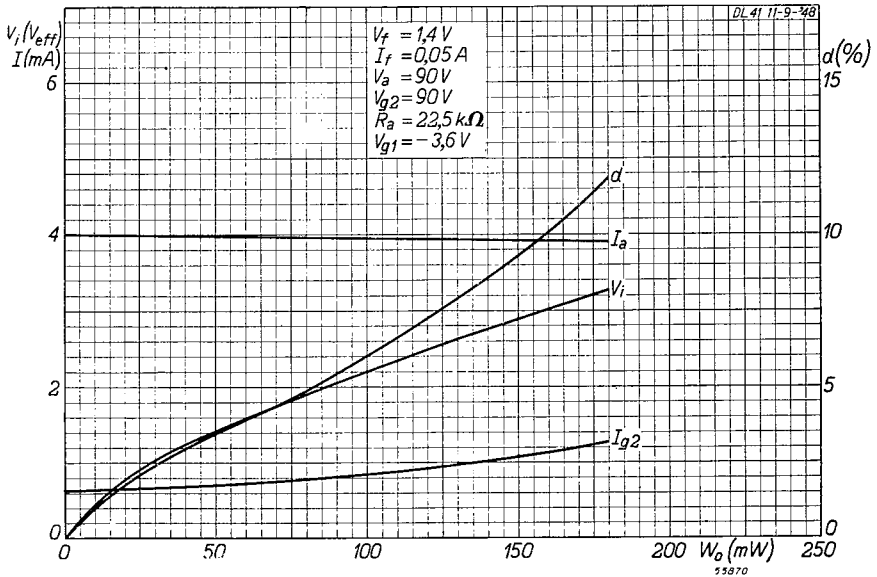

Fig. 5
 Anode current (I_a), screen grid current (I_{g2}), distortion (d) and alternating grid voltage (V_i) as functions of the output (W_o), with a battery supply of 90 V. Filament connections 1 and 8 ($V_f=1.4$ V, $I_f=50$ mA).

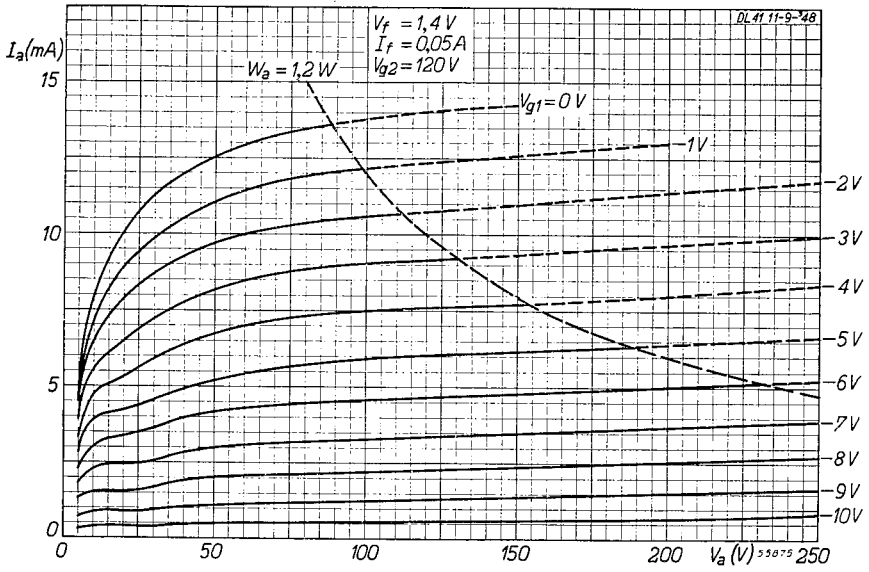

Fig. 6
 As Fig. 4, but for a 120 V battery. Filament connections 1 and 8
 ($V_f = 1.4 V$, $I_f = 50 mA$).

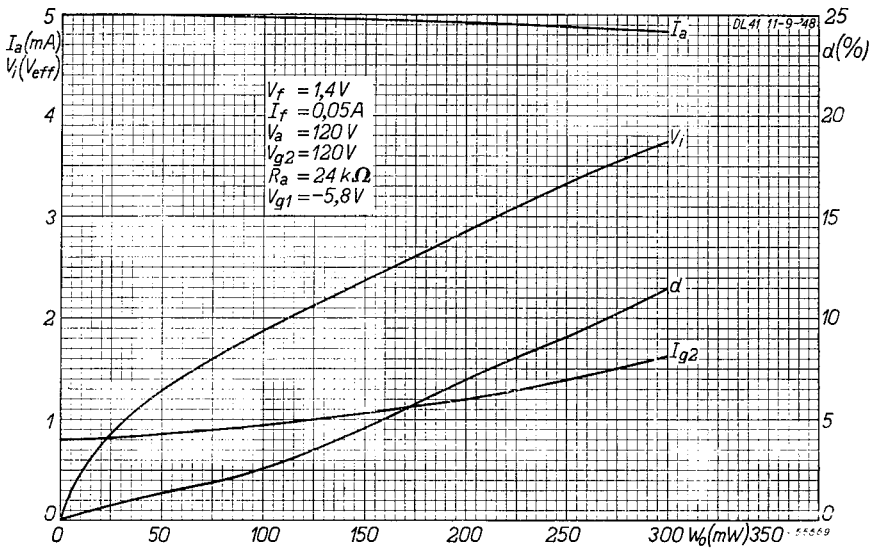

Fig. 7
 As Fig. 5, but for a 120 V battery. Filament connections 1 and 8
 ($V_f = 1.4 V$, $I_f = 50 mA$).

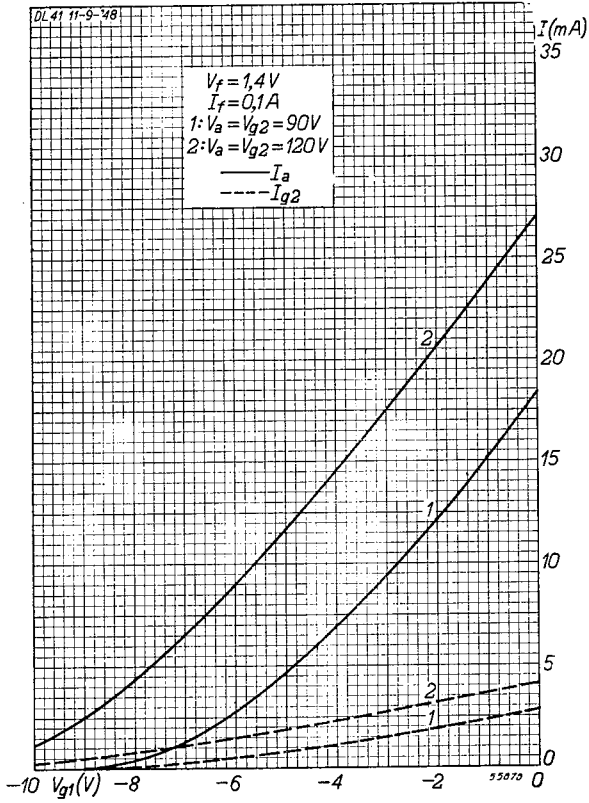

Fig. 8
 Anode current (I_a) and screen grid current (I_{g2}) as functions of the grid bias (V_{g1}), with battery voltages of 90 and 120 V. Filament connections 1 and 7+8 ($V_f = 1.4\text{ V}$, $I_f = 0.1\text{ A}$).

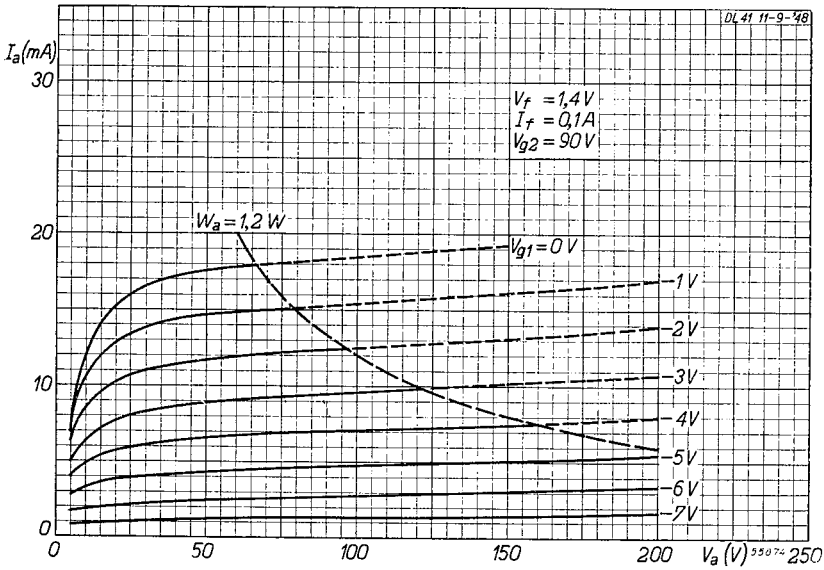

Fig. 9
 I_a / V_a characteristics for a screen grid voltage of 90 V. Filament connections 1 and 7+8 ($V_f=1.4$ V, $I_f=100$ mA).

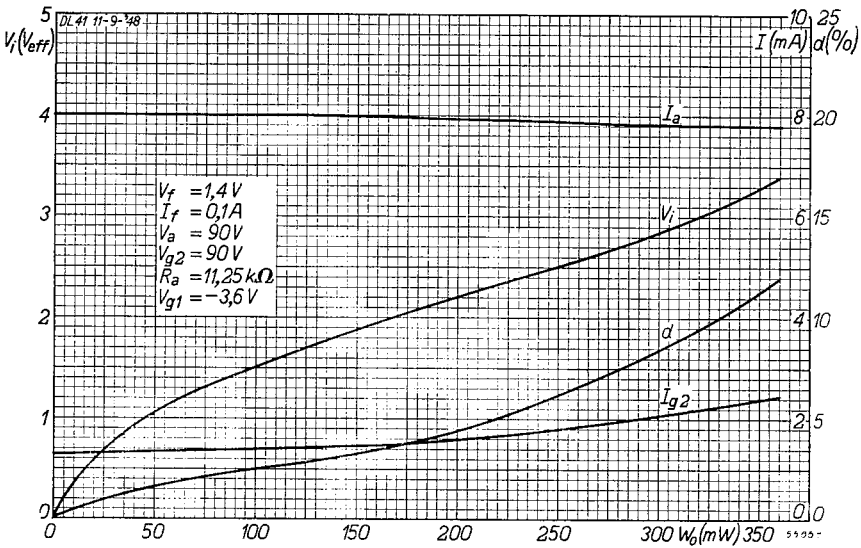

Fig. 10
 Anode current (I_a), screen grid current (I_{g2}), distortion (d) and alternating grid voltage (V_i) as functions of the output power (W_o). 90 V battery. Filament connections 1 and 7+8 ($V_f=1.4$ V, $I_f=100$ mA).

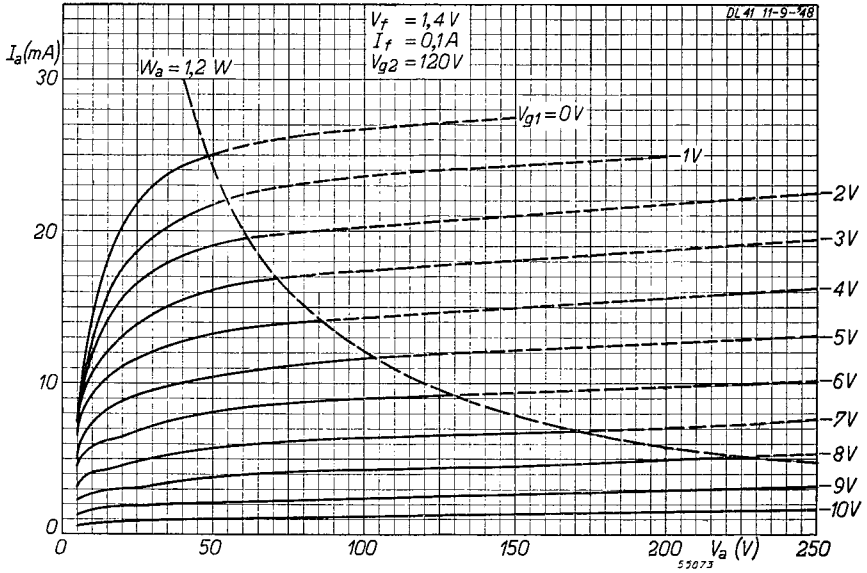

Fig. 11
 As Fig. 9, but for a screen grid voltage of 120 V. Filament connections 1 and 7+8 ($V_f=1.4 \text{ V}$, $I_f=100 \text{ mA}$).

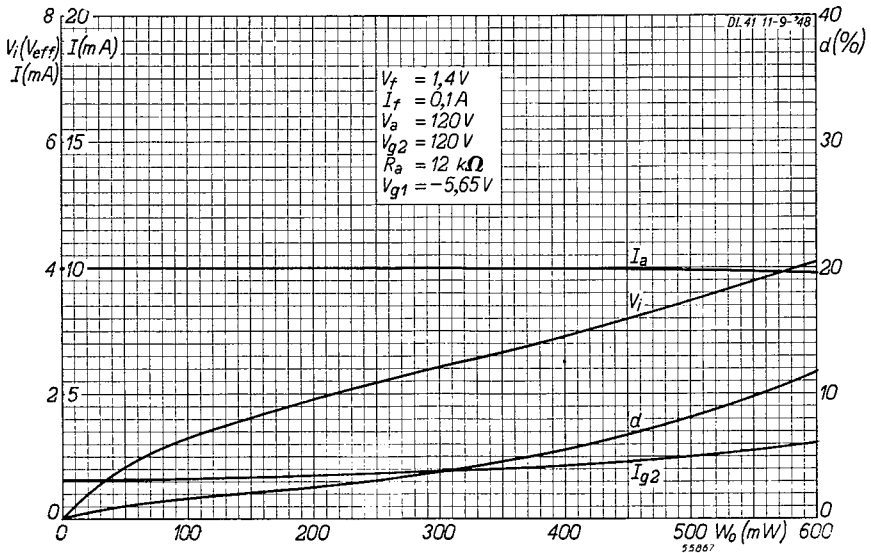

Fig. 12
 As Fig. 10, but for a 120 V battery. Filament connections 1 and 7+8 ($V_f=1.4 \text{ V}$, $I_f=100 \text{ mA}$).

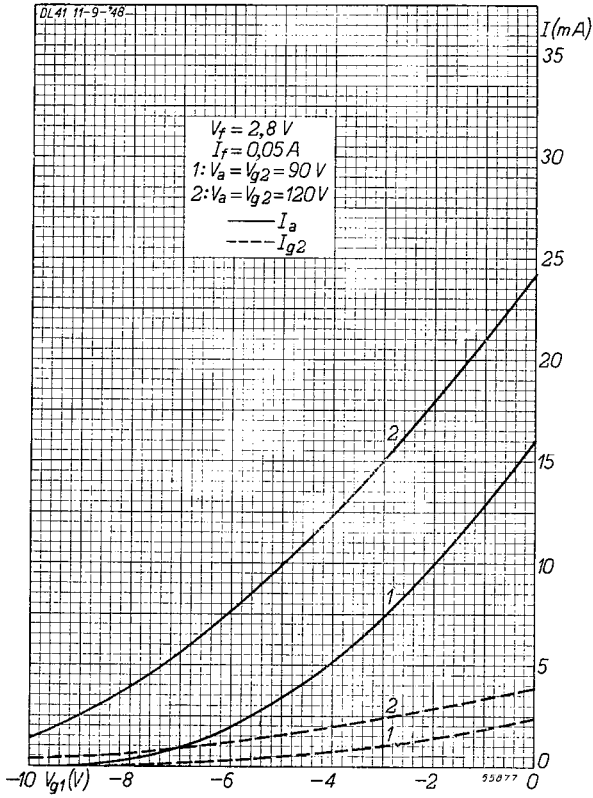

Fig. 13
 Anode current (I_a) and screen grid current (I_{g2}) as functions of the grid bias (V_{g1}), with 90 V and 120 V batteries. Filament connections 7 and 8 ($V_f = 2.8$ V, $I_f = 50$ mA).

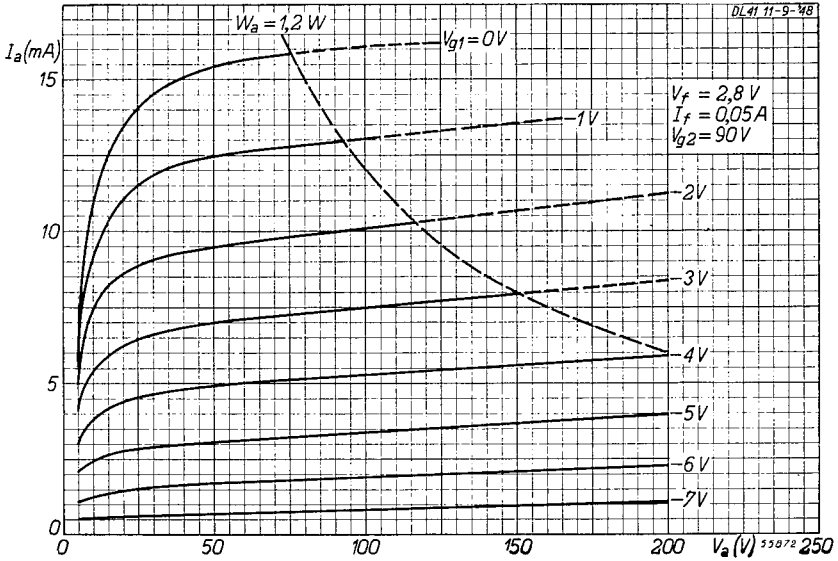

Fig. 14
 I_a/V_a characteristics for a screen grid voltage of 90 V. Filament connections 7 and 8 ($V_f=2.8 V$, $I_f=50 mA$).

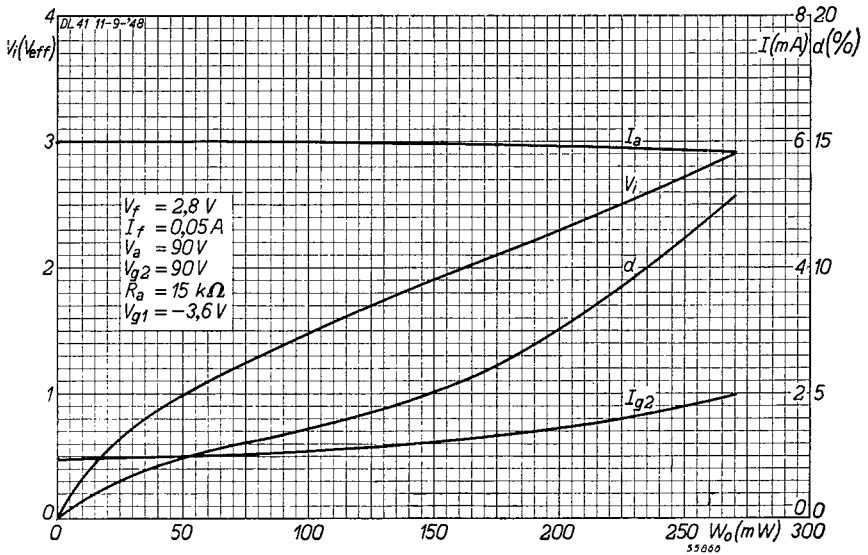

Fig. 15
 Anode current (I_a), screen grid current (I_{g2}), distortion (d) and alternating grid voltage (V_i) as functions of the output power (W_o). 90 V battery. Filament connections 7 and 8 ($V_f=2.8 V$, $I_f=50 mA$).

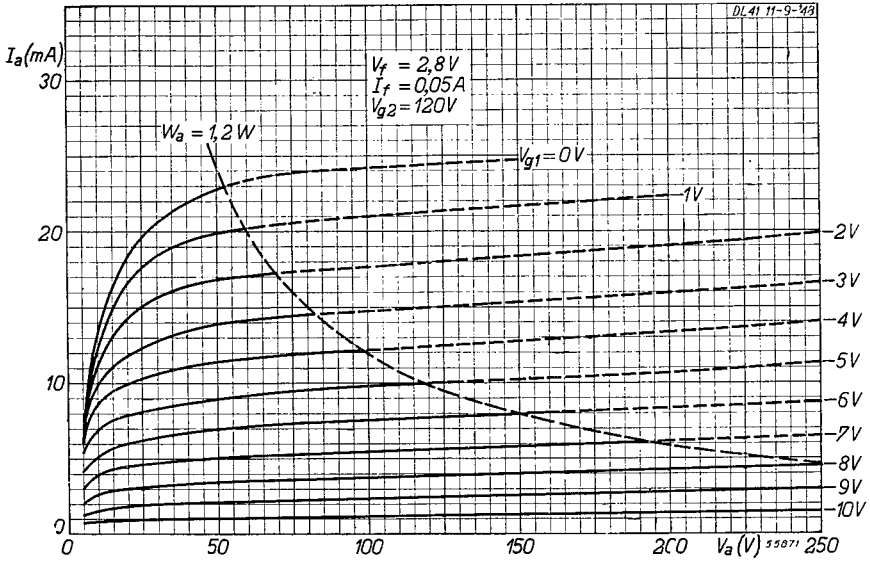

Fig. 16
 As Fig. 14, but for a screen grid voltage of 120 V. Filament connections 7 and 8 ($V_f=2.8$ V, $I_f=50$ mA).

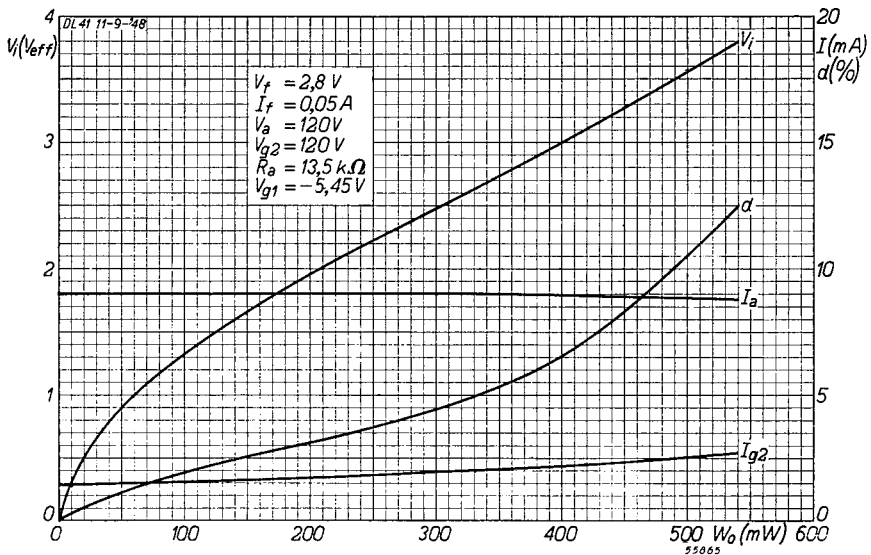

Fig. 17
 As Fig. 15, but for a 120 V battery. Filament connections 7 and 8 ($V_f=2.8$ V, $I_f=50$ mA).

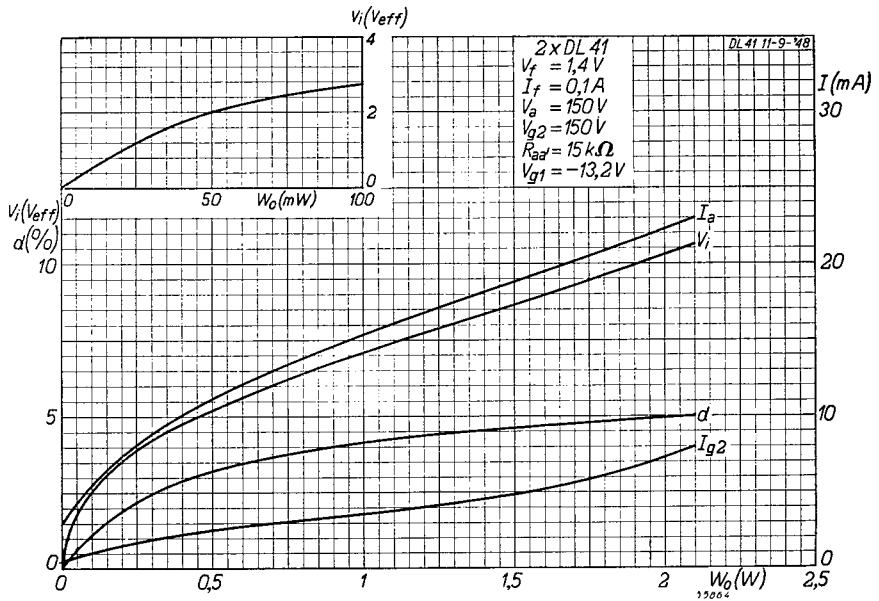

Fig. 18

Total anode current (I_a), total screen grid current (I_{g2}), distortion (d) and alternating grid voltage (V_i) as functions of the output (W_o) in Class B operation. 150 V battery. Filament connections 1 and 7 + 8 ($V_f=1.4\ V$, $I_f=100\ mA$). The inset shows the alternating grid voltage at lower output values.

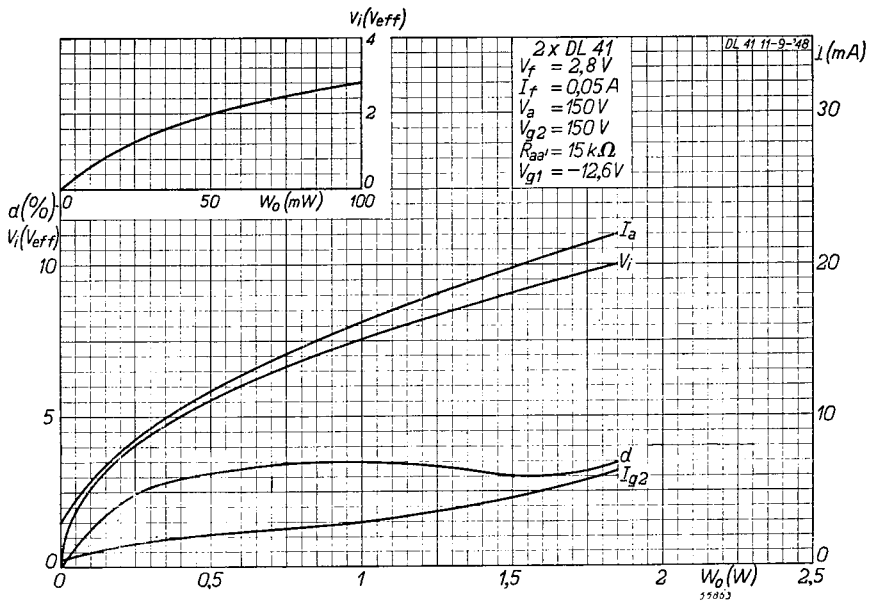

Fig. 19

As Fig. 18, but for filament connections 7 and 8 ($V_f=2.8\ V$,

X. A battery receiver with 4 Rimlock valves

Introduction

This receiver contains four Rimlock type battery valves, viz.

- DK 40 — octode frequency changer,
- DAF 40 — detector diode and I.F. amplifying pentode,
- DAF 41 — A.G.C. diode and A.F. amplifying pentode,
- DL 41 — output pentode,

and is designed for three wave-bands, viz.

- long waves: approx. 800—2000 m,
- medium waves: approx. 200— 600 m,
- short waves: approx. 15— 50 m.

The high sensitivity of this receiver, which averages 15 μ V, is attributable to the excellent characteristics of the frequency changer. Another feature of this design is the very low current consumption of only 150 mA for the filaments and about 10 mA for the anodes and screen grids, with a battery voltage of 90 V.

Description of the circuit

The mixing stage

Aerial circuits with high primary self-inductance ensure constant aerial gain over the entire wave-band. The A.G.C. voltage is applied to the bottom of the tuned circuits (Fig. 1), except for short-wave reception, when the A.G.C. is rendered inoperative, as it might otherwise give rise to excessive frequency drift in the oscillator.

In the oscillator section, the tuned circuits are incorporated in the anode circuit: from the point of view of a constant frequency, this gives much better results than a tuned grid circuit.

On medium and long wavelengths the coupling coils are connected to the top of the padding capacitors, as this yields a more constant oscillator voltage throughout the entire wave-band. It is recommended, moreover, that the coupling coils be damped by means of extra parallel resistors, viz: 5.6 k Ω across L_{10} , and 1.2 k Ω across L_{12} . Since no padding capacitor is used on short-wave reception, extra voltage gain is obtained from a circuit comprising L_9 and a 56 pF capacitor, connected in parallel with the coupling coil. The resonant frequency of this circuit occurs roughly at 60 m and the oscillator voltage for the lowest frequencies in the short-wave band is thus intensified. Fig. 2 shows the oscillator grid current as function of the frequency, for all three wave-bands.

The inevitable parasitic coupling between the oscillator section and the fourth

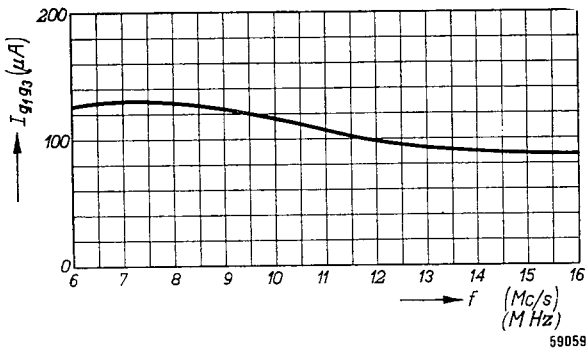
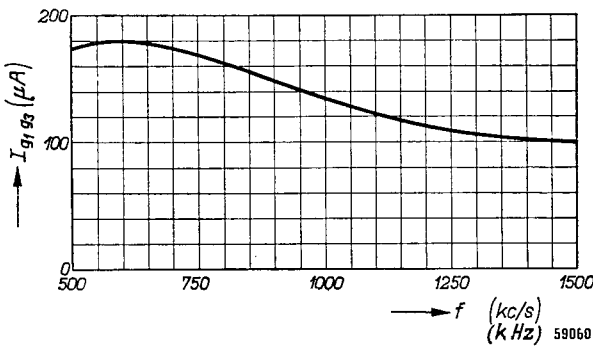
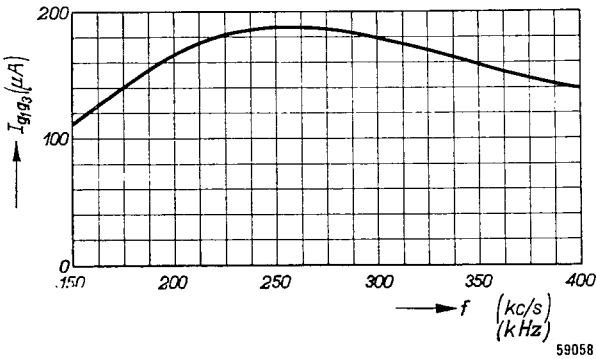
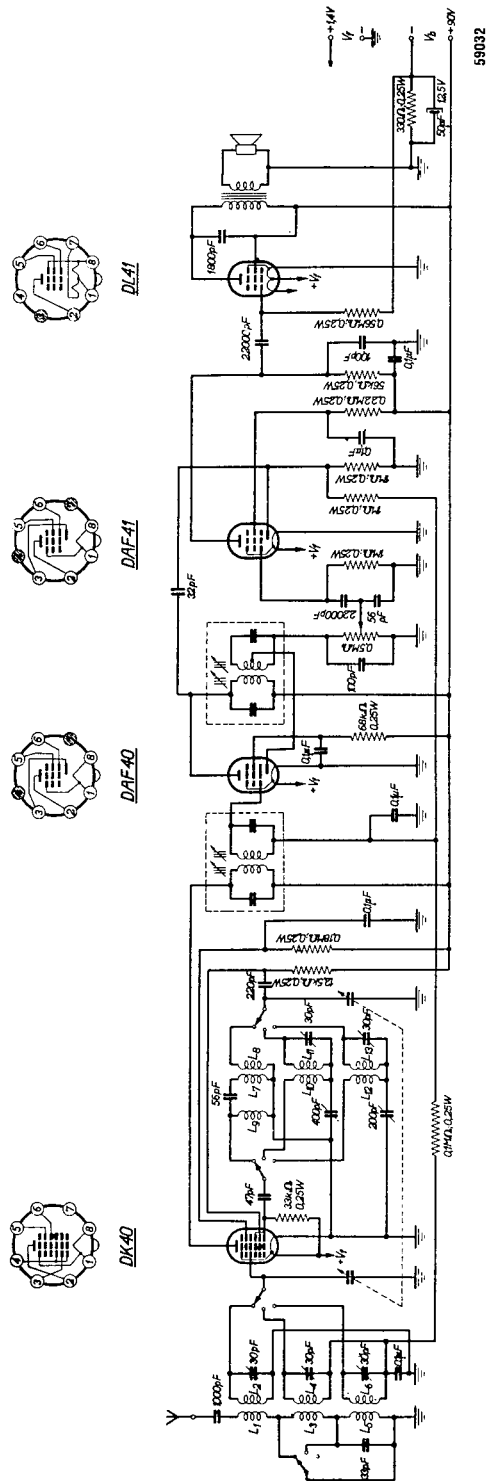

Fig. 2

Oscillator grid current flowing through the grid leak, as function of the frequency for the three wave-bands.

grid of the frequency changer induces a voltage at oscillator frequency in the aerial circuit; in view of the fact that this voltage produces intense aerial radiation and might also have an adverse effect on the conversion gain, it is advisable to compensate the unwanted coupling. A simple means of effecting this compensation consists in introducing a neutrodyne capacitor of about 3.3 pF between the first and fourth grids. As an alternative, the wiring may be arranged to provide the necessary capacitance: if the wiring beyond the wavelength switch is used for this purpose, it is even possible to vary the compensation for the different wave-bands individually. Such compensation also reduces any tendency towards "pulling" (the dependence of the oscillator frequency on the capacitance of the aerial circuits). To give an impression of the order of size of the oscillator voltage induced on the fourth grid when the extra capacitance is introduced, the results of a few measurements on a laboratory model are reproduced on the following table:



590032

Fig. 1
Circuit of battery receiver with 4 Rimlock valves.

Long waves		Medium waves		Short waves	
400 kc/s	140 mV	1400 kc/s	110 mV	13.5 Mc/s	150 mV
250 kc/s	110 mV	1000 kc/s	90 mV	9 Mc/s	100 mV
160 kc/s	65 mV	500 kc/s	80 mV	6 Mc/s	60 mV

These voltages are of course attenuated by reason of the selective action of the circuits and aerial coupling, so that the actual radiation voltages on the aerial are much lower.

The self-inductances, quality and coupling factors of each oscillator coil, applicable to all three wave-bands, are specified in the following table :

Coil	Number of turns	Type of wire	Self-inductance	Q	$t=M/L$
L_7	11 3/8	0.1 mm	—	—	0.83
L_8	19 1/4	90 × 0.03 mm	1.42 μ H	120	
L_9	40 3/4	0.1 mm	17.92 μ H	40	
L_{10}	36	0.1 mm	—	—	0.4
L_{11}	105	0.1 mm	122.4 μ H	75	
L_{12}	45	0.1 mm	—	—	0.29
L_{13}	245	0.1 mm	646.6 μ H	35	

If necessary, coil L_9 can be wound on the same bobbin as L_7 and L_8 ; bobbins of 8 mm diameter are used for all coils.

When an I.F. transformer with a quality factor Q of 140 (say a Philips I.F. transformer 5730) is used in the anode circuit of the DK 40, the conversion gain of this circuit will be approximately 80. Taking into account the average voltage gain across the aerial coupling (by a factor of $4\frac{1}{2}$), the overall gain from aerial socket to control grid of the DAF 40 is about 360.

The I.F. amplifying stage

The diode of the DAF 40, connected to a tapping ($t=0.7$) on the secondary winding of the I.F. transformer, functions as detector. The quality factor and tuning capacitance of this transformer (452 kc/s) are similar to those of the anode circuit of the frequency changer. The I.F. voltage on the primary is rectified by the diode of the DAF 41, to provide the necessary A.G.C.

voltage, and Fig. 3 depicts the A.G.C. curve for an input signal of 1000 kc/s; on short wavelengths this curve is steeper since the frequency changer is functioning without A.G.C.

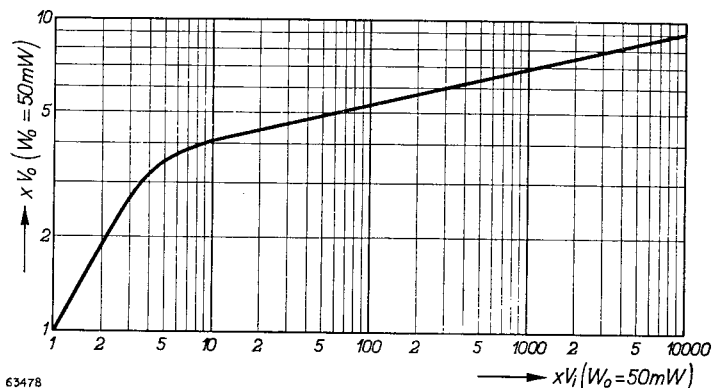

Fig. 3
A.G.C. characteristic of the receiver.

1.F. and output amplification

The amplification in the pentode section of the DAF 41 is restricted to a factor of about 35 by the presence of a coupling resistor of relatively low value in the anode circuit. A higher amplification is obtainable, but is not necessary in this circuit; moreover, the risk of microphony is only small at this low amplification level, even if the position in which the valve is mounted is unfavourable.

In view of the limited output power of battery-operated output valves, a high-efficiency output transformer is of primary importance.

With a battery voltage of 90 V, the output power is 110 mW with 10% distortion, using only one half of the filament of the output valve. The output can be increased, but only at the expense of the total current consumption. When the battery voltage is increased to 120 V, an output of 215 mW is attainable, but the feeds for the DK 40 and DAF 40 must then be reduced by means of a decoupled 7000 ohm dropping resistor.

Another method of increasing the output power is to connect the two halves of the filament of the DL 41 in parallel by interconnecting pins 7 and 8 on the valve base. This, however, increases the total filament current to 200 mA, and the anode current to 15 mA: the output power with a battery voltage of 90 V is then 230 mW with a matching resistance of 11.3 k Ω , or with 120 V, 440 mW. The choice naturally depends on the output power required and the desired maximum current consumption. The following values of currents and voltages are based on minimum current consumption.

A decoupled 330 ohm resistor in the negative line of the battery provides the 3.4 V grid bias for the output valve. If the filaments are connected in parallel, however, a resistor of only 240 ohms is needed.

MEASURED VALUES

Voltages and currents with a battery voltage V_b of 90 V

DL 41 - output valve

Anode voltage	78	V
Screen grid voltage	85	V
Grid bias	-3.4	V
Anode current	4.2	mA
Screen grid current	1	mA

DAF 41 - A.G.C. diode and A.F. amplifier

Anode voltage	40	V
Screen grid voltage	44	V
Anode current	0.8	mA
Screen grid current	0.18	mA

DAF 40 - detector diode and I.F. amplifier

Anode voltage	85	V
Screen grid voltage	69	V
Anode current	0.88	mA
Screen grid current	0.21	mA

DK 40 - frequency changer

Anode voltage	85	V
Screen grid voltage (V_{g5})	66	V
Grid No. 2 voltage	55	V
Anode current	0.9	mA
Screen grid current (I_{g5})	0.1	mA
Grid No. 2 current	2.5	mA

Sensitivity

With an aerial gain of 3 to 6 across the aerial circuit, at the standard output power of 50 mW and a 90 V battery, the aerial sensitivity is as follows :

Input signal frequency	Sensitivity
170 kc/s	12 μV_{RMS}
250 kc/s	15 μV_{RMS}
370 kc/s	14 μV_{RMS}
600 kc/s	9 μV_{RMS}
1000 kc/s	13 μV_{RMS}
1400 kc/s	10 μV_{RMS}
6 Mc/s	24 μV_{RMS}
9 Mc/s	20 μV_{RMS}
13 Mc/s	23 μV_{RMS}

Selectivity

1 : 10 when the receiver is detuned ± 5 kc/s
1 : 100 ,, ,, ,, ,, ,, ± 11 kc/s

Miscellaneous Rimlock type amplifying valves

Four Rimlock type valves which were not designed especially for broadcast receivers, but which can be used for special purposes in such sets, are described in this section: two of these valves, the double triode ECC 40 and the pentode EF 40, were developed primarily for A.F. amplifiers, whilst the other two, the R.F. pentodes EF 42 and UF 42, in view of their high mutual conductances and relatively low capacitances, are particularly suitable for wide-band amplification. A brief description of these valves is given below, and, in the following pages, a detailed description of each valve.

ECC 40 : a double triode specially designed as an A.F. amplifier-phase inverter. Each section has an amplification factor of 32, with a slope of 2.9 mA/V.

EF 40 : a pentode with a straight characteristic and a slope of 1.85 mA/V, intended for A.F. amplification in very sensitive amplifiers, but also suitable for use in high-fidelity receivers. Every effort has been made to reduce hum, valve noise and microphony to a minimum.

EF 42 and UF 42 : two R.F. pentodes, one for A.C. receivers, the other for A.C./D.C. sets. Both have very high mutual conductances ($S=9$ mA/V and 8 mA/V respectively), whereas input and output capacitances are comparatively low. These valves are particularly suitable for wide-band R.F. amplification, e.g. in television and F.M. receivers.

ECC 40

ECC 40 Double triode

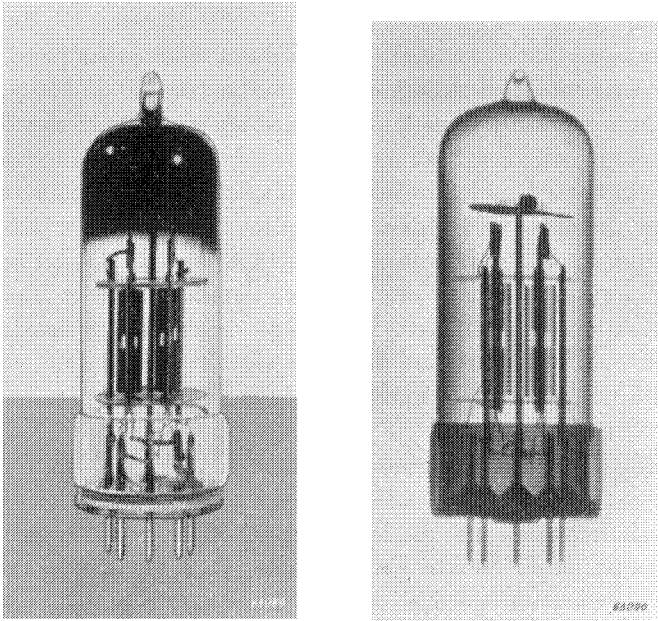

Fig. 1

Normal and X-ray photographs of the ECC 40 (approximately actual size).

The ECC 40 is an indirectly heated double triode, of which the two sections, apart from the heaters, are completely separate. This valve is intended primarily for use as an A.F. amplifier and phase inverter, but is also suitable for other purposes, for example as an oscillator, frequency changer, blocking oscillator, etc., in u.s.w apparatus. It is also being more and more widely used for electronic counters and calculating and accounting machines. The fact that the valve would often be called upon to meet much more stringent conditions than when used for normal A.F. amplification was taken into consideration in its development; to mention only one factor, the maximum permissible voltage between heater and cathode is 175 V, whereas a maximum of 50 V is usually high enough for E-type valves intended only for use in ordinary amplifiers and broadcast receivers.

The amplification factor of each section of the ECC 40 is 32 and the mutual conductance 2.9 mA V; each section is therefore capable of providing a reasonable gain while it will also function efficiently as an oscillator. The heaters of the two sections are connected in parallel and, as the heater current is 0.3 A in each case, the total heater current is 0.6 A at a voltage of 6.3 V.

The capacitances between the electrodes of both triodes are kept as low as possible. Thus the coupling between the sections is reduced to a minimum, which is a matter of great importance when the valve is used as a cascade amplifier. Since very high amplification is obtainable under such conditions, care must be taken with the wiring, as the circuit is otherwise liable to become unstable. If necessary, a neutralizing capacitor may be included between anode and grid of one of the triodes (see Fig. 4).

When it is intended to use the ECC 40 as an A.F. amplifier, it is important to know something of its microphonic tendencies: these, however, depend on whether the valve is to be used in a receiver or in an amplifier. In the former, it is usually located in the same cabinet as the speaker, but this is not usually the case in amplifiers; microphony is therefore less likely to occur in an amplifier, and greater amplification may be employed.

Let us first consider the question of receivers: it is generally safe to assume that there will be no risk of microphony in the circumstances outlined in the descriptions of the EAF 42 and EBC 41, when an alternating input voltage of at least 5 mV is required for the output valve to deliver 50 mW. When the ECC 40 is used in an A.F. amplifier, the likelihood of microphony is naturally dependent to a great extent on the position of the loudspeaker(s). To give some idea of the maximum gain which can be tolerated without special measures to prevent microphony, it is assumed that the sound level at the position of the ECC 40 corresponds to that obtained from a loudspeaker with an acoustic efficiency of 5% to which an input of 5 W is applied, the distance from the valve being about 10 cm. The gain can now be increased to the point where a voltage of 50 mV is needed for the input of the ECC 40. It should be pointed out, however, that the values mentioned in the foregoing are intended only as a general guide, and may well be adversely affected by actual working conditions (see description of the EBC 41).

In order to suppress hum as much as possible, it is recommended that a potentiometer, of which the sliding contact is earthed, be connected across the heater of the ECC 40, and adjusted until the hum is at a minimum. A suitable value for the resistance of the potentiometer would be 50 Ω .

It is also advisable that the impedance of the control grid circuit at the hum frequency be kept as low as possible: generally speaking, as long as this impedance is kept to within 0.3 M Ω in circuits such as those mentioned in connection with microphony, the hum will be sufficiently suppressed.

ECC 40

TECHNICAL DATA OF THE DOUBLE TRIODE ECC 40

Heater data

Heating: indirect, A.C. or D.C., parallel feed. The heaters of the two sections are connected in parallel.

Heater voltage	V_f	=	6.3 V
Heater current	I_f	=	0.6 A

Capacitances (cold valve)

First triode section

Input capacitance	C_g	=	2.8 pF
Output capacitance	C_a	=	1.1 pF
Between grid and anode	C_{ag}	=	2.7 pF
Between grid and heater	C_{gf}	<	0.1 pF
Between cathode and heater	C_{kf}	=	3 pF

Second triode section

Input capacitance	$C_{g'}$	=	2.6 pF
Output capacitance	$C_{a'}$	=	0.7 pF
Between grid and anode	$C_{a'g'}$	=	2.8 pF
Between grid and heater	$C_{g'f}$	<	0.1 pF
Between cathode and heater	$C_{k'f}$	=	3 pF

Between the two triode sections

Between anode of section I and anode of section II	$C_{aa'}$	<	0.8 pF
Between grid of section I and grid of section II	$C_{gg'}$	<	0.1 pF
Between anode of section I and grid of section II	$C_{ag'}$	<	0.1 pF
Between anode of section II and grid of section I	$C_{a'g}$	<	0.1 pF

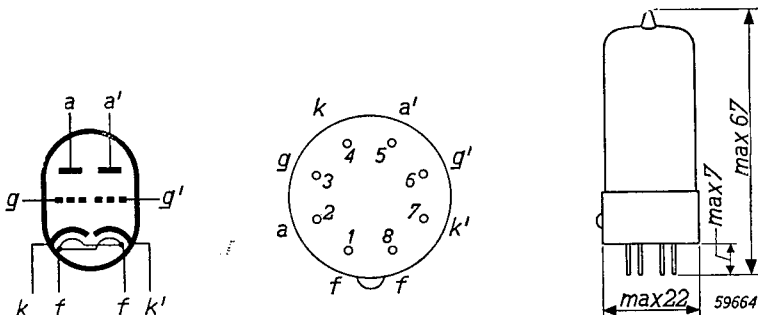

Fig. 2
Electrode arrangement, electrode connections and dimensions in mm of the ECC 40.

Typical characteristics of the ECC 40 (each section)

Anode voltage	V_a	=	250 V
Cathode resistor	R_k	=	920 Ω
Anode current	I_a	=	6 mA
Mutual conductance	S	=	2.9 mA/V
Internal resistance	R_i	=	11 k Ω
Amplification factor	μ	=	32

Limiting values of the ECC 40 (each section)

Anode voltage, valve biased to cut-off	V_{a_0}	= max.	550 V
Anode voltage	V_a	= max.	300 V
Anode dissipation	W_a	= max.	1.5 W
Grid dissipation	W_g	= max.	0.1 W
Cathode current	I_k	= max.	10 mA
Grid current starting point	$V_g(I_g = +0.3 \mu A)$	= max.	-1.3 V
External resistance between grid and heater	R_g	= max.	1 M Ω
External resistance between heater and cathode	R_{jk}	= max.	0.15 M Ω
Voltage between heater and cathode (f neg., k pos.)	V_{fk}	= max.	175 V
(f pos., k neg.)	V_{jk}	= max.	100 V

The ECC 40 used as an A.F. amplifier

A. Operating characteristics: one section

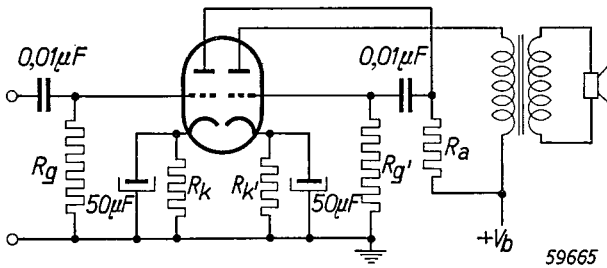

Fig. 3
The ECC 40 as combined A.F. amplifying and output valve.

Supply voltage	V_b	=	250	250 V
Anode resistor	R_a	=	0.1	0.22 M Ω
Cathode resistor	R_k	=	2.2	2.2 k Ω
Grid resistor	R_g	=	1	1 M Ω
Grid resistor, section II	R'_g	=	0.33	0.68 M Ω
Anode current	I_a	=	1.4	0.9 mA
Output voltage	V_o	=	30	18 V_{RMS}
Amplification	V_o/V_i	=	24	25
Distortion	d_{tot}	=	2.2	1.3 %

ECC 40

B. Operating characteristics: two sections in cascade (see Fig. 4)

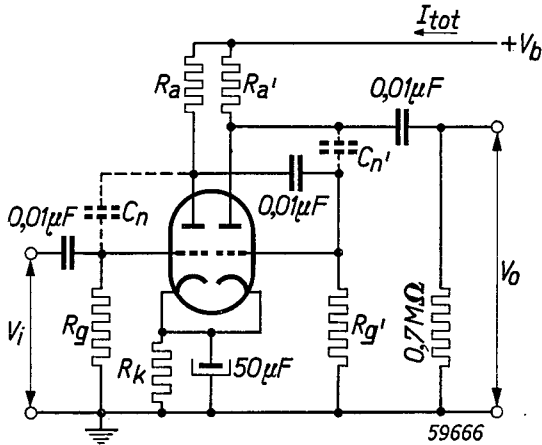

Fig. 4
The ECC 40 as A.F. cascade amplifier
 C_n and C_n' are neutralizing capacitors, one of which may be used if the amplifier is rendered unstable by parasitic wiring capacitances. $R_g = R_g' = 1 \text{ M}\Omega$; $R_k = 1 \text{ k}\Omega$.

Supply voltage	V_b	=	250	250 V
Anode resistor, section I . . .	R_a	=	0.22	0.22 M Ω
Anode resistor, section II . . .	R_a'	=	0.1	0.22 M Ω
Total current	I_{tot}	=	2.5	2.0 mA
Amplification	V_o/V_i	=	740	780
Output voltage	V_o	=	30	18 V _{RMS}
Distortion	d_{tot}	=	1.9	1.2 %

Provided that the wiring is carefully laid out, it is possible, in spite of the high amplification, to ensure complete stability of the amplifier. If difficulties are encountered, a neutralizing capacitor (C_n or C_n') may be connected between anode and grid of one of the triodes, a suitable value for all frequencies being about 4 pF.

The ECC 40 used as an output valve

A. Operating characteristics: one section used as a Class A output valve (Fig. 3)

Anode voltage	V_a	=	250 V
Cathode resistor	R_k	=	920 Ω
Anode current	I_a	=	6.0 mA
Mutual conductance	S	=	2.9 mA/V
Internal resistance	R_i	=	11 k Ω
Amplification factor	μ	=	32
Matching resistance	R_a	=	15 k Ω

See page 325

Output power	W_o	=	280 mW
Required alternating input voltage	V_i	=	3.9 V_{RMS}
Distortion	d_{tot}	=	8.5 %

B. Operating characteristics: both sections used in class A push-pull

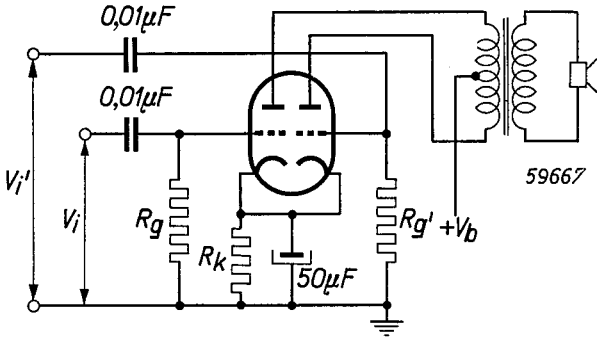

Fig. 5
The ECC 40 used as a push-pull output valve.

Anode voltage	V_a	=	250	V
Common cathode resistor	R_k	=	560	Ω
Matching resistance	R_{aa}	=	30	k Ω
Alternating input voltage	$V_i = V_i'$	=	0	4.1 V_{RMS}
Anode current	I_a	=	2×5.2	2×5.6 mA
Output power	W_o	=	0	520 mW
Distortion	d_{tot}	=	—	1.0 %

The ECC 40 used as a phase inverter

As is generally known, the output stage in a push-pull amplifier or receiver will not function properly unless the alternating input voltage applied to the control grid of one of the output valves is equal to and in counter-phase with the input of the other valve. To obtain these voltages in modern mains receivers, it is usual to employ a circuit comprising two valves together with the necessary resistors and capacitors; the ECC 40, which is in effect two valves in one envelope, is ideal for this purpose. In the following paragraphs, a number of circuits employing the ECC 40 as a phase inverter are described in detail.

A. Phase inverter, using an unbypassed cathode resistor (Fig. 6)

Fig. 6 shows a circuit in which the first triode section serves as a normal A.F. amplifier. The amplified voltage is then applied to the second triode, which

ECC 40

has equal, unbypassed resistors in its anode and cathode leads. The voltages across these resistors, equal but in counter-phase, are applied, through capacitors, to the control grids of the push-pull output valves. Since the high cathode resistance tends to produce a strong negative bias on the grid of the second triode, this grid is connected to the anode of the first triode. The value of the anode resistor of the first triode is such that a suitable bias is obtained on the grid of the second triode.

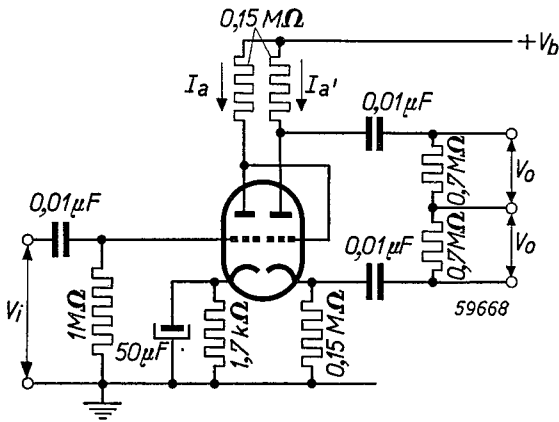

Fig. 6
The ECC 40 used as a phase inverter, with output voltages taken from similar resistors in the anode and cathode circuits of the second triode.

Supply voltage	V_b	= 250	350 V
Anode current, section I . . .	I_a	= 1.12	1.57 mA
Anode current, section II . . .	I_a'	= 0.55	0.78 mA
Amplification	V_o/V_i	= 27	27
Output voltage	V_o	= 18	30 V_{RMS}
Distortion	d_{tot}	= 1.0	1.0 %

B. Balanced phase inverter (Fig. 7)

Another circuit employing the ECC 40 as a phase inverter, but working on a completely different principle, is shown in Fig. 7. In this arrangement the first triode is again used as a normal A.F. amplifier, the amplified voltage being supplied, through capacitor C_1 and potentiometer R_1, R_g' , to the control grid of the second triode. The amplified voltages on the two anodes, V_o and V_o' , are applied, through capacitors C_1 and C_2 , to the control grids of the output valves.

To ensure equality of the voltages V_o and V_o' , it is essential that the ratio

$(R_1 + R_g)$ to R_g' is equal to the gain of the second triode system. This is the only disadvantage of the circuit: if the gain for some reason undergoes a change, V_o will no longer equal V_o' . On the other hand, this circuit has a distinct advantage over the arrangement described above in that the common cathode resistor requires no decoupling capacitor. Since the alternating components in the cathode currents of the two sections are equal and in counter-phase, their resultant is zero.

Supply voltage	V_b	= 250	350 V
Common cathode resistor	R_k	= 1.0	0.75 kΩ
R'_g (see Fig. 7)	R'_g	= 27.3	26.2 kΩ
Total current	I_{tot}	= 3.0	4.3 mA
Amplification	V_o/V_i	= 26	27.5
Output voltage	V_o	= 30	30 V _{RMS}
Distortion, triode I	d'_{tot}	= 1.5	1.1 %
Distortion, triode II	d'_{tot}	= 0.5	0.3 %

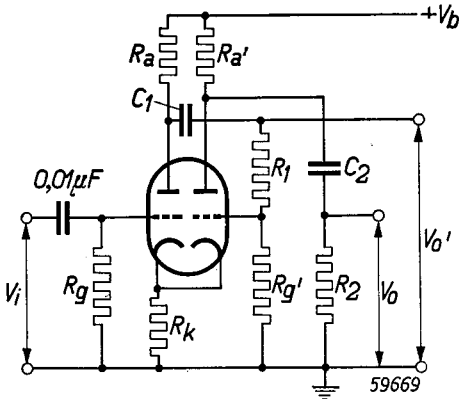

Fig. 7

The ECC 40 used as a balanced phase inverter. $R_g = R_1 = R_2 = 0.7$ MΩ. $R_a = R'_a = 0.1$ MΩ. $C_1 = C_2 = 0.01$ μF.

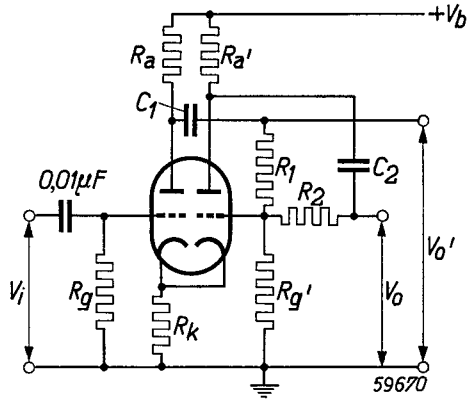

Fig. 8

The same circuit as in Fig. 7, but with negative feedback applied to the second triode by means of C_2 and R_2 . $R_g = 0.7$ MΩ. $R'_g = 0.22$ MΩ. $R_a = R'_a = 0.15$ MΩ. $R_k = 1.1$ kΩ. $R_1 = 0.41$ MΩ. $R_2 = 0.47$ MΩ. $C_1 = R_2 = C_2 = 0.02$ μF.

C. Balanced phase inverter circuit with feedback (Fig. 8)

To avoid the drawbacks inherent in the circuit described in para. B, the arrangement shown in Fig. 8 can be employed. In this case a balanced output is assured by using negative feedback to stabilize the gain of the second triode. By this method, variations in the valve characteristics are made to have much less effect on the equality of the counter-phase output voltages.

ECC 40

The ECC 40 used as a generator of saw-tooth voltages (blocking oscillator)

Saw-tooth voltages are used for the movement of the spot across the screen of the cathode-ray tube in a television receiver or an oscillograph; various circuits have been designed for the purpose of generating these voltages, and one of these, the blocking oscillator, is described below. In this particular circuit the ECC 40 is used, only one section acting as the actual oscillator. In order to synchronize the scanning of the picture tube in television receivers with the point-to-point scanning of the object by the camera tube, synchronizing pulses are included in the transmitted signal. The second triode of the ECC 40 serves to feed these pulses to the blocking oscillator in a suitable manner.

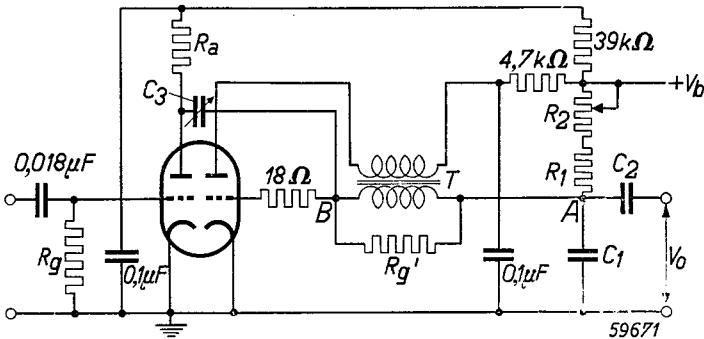

Fig. 9

The ECC 40 used as a generator of saw-tooth voltages. $C_1 = 560$ pF.
 $R_1 = 0,1$ M Ω . $R_2 = \text{max. } 0,1$ M Ω .

The circuit of the synchronized blocking oscillator is reproduced in Fig. 9. The action of the oscillator itself, comprising section II with appropriate circuit, can be described as follows: assume that at a given moment capacitor C_1 is charged to such an extent that the potential at the point A is strongly negative with respect to the cathode potential. The potential on the grid of the second triode is then equally negative, and the system is biased to cut-off.

The capacitor C_1 discharges through the resistors R_1 and R_2 , and the voltage across C_1 gradually decays until the triode is no longer biased to the point of cut-off. At this stage, anode current commences to flow through the primary of transformer T , producing in the secondary winding a voltage such that point B becomes positive with respect to point A. This accelerates the rise in anode current, so that the potential at B becomes more and more positive, and so on. The voltage on the grid consequently reaches a very high positive value with respect to cathode potential, and the capacitor C_1 is therefore very quickly charged by the grid current.

Since the anode voltage drops when the anode current increases, the increase in anode current is not unlimited, and, in a short time, the induced voltage between B and A becomes zero, and the grid potential again becomes strongly

negative, owing to the voltage across C_1 . The whole process then repeats itself.

The voltage across C_1 is taken by the capacitor C_2 to the output terminal. While C_1 is being discharged, the voltage between this terminal and earth increases gradually, to drop suddenly during the time that the triode is passing current. The required saw-tooth voltage across the output terminals is thus produced.

The frequency of the voltage can be regulated by means of the variable resistor R_2 , with components of the values indicated in the circuit diagram. a frequency of about 15 kc/s will be obtained.

The synchronizing pulses are applied to the grid of triode I, the amplified pulses in the anode circuit being taken by trimmer C_3 to the point B in the circuit of triode II. This means that a positive voltage surge arrives at B at the correct moment, as a result of which C_1 , instead of being further discharged, is re-charged.

In other words, the rise in the saw-tooth voltage is checked at the correct moment, and the movement of the spot in the C.R. tube is thus synchronized with the scanning of the object at the transmitting station. A condition on which the success of the process depends is of course that the natural frequency of the oscillating circuit shall be slightly lower than the frequency of the synchronizing pulses.

The ECC 40 used in electronic counters

An instrument employed on an ever-increasing scale for industrial purposes is the electronic counter. This instrument is capable of counting objects, or recurring phenomena, with great accuracy and at a speed of almost 10^6 per second.

Essentially, the action of the instrument is as follows: for each object or phenomenon to be counted, an electrical impulse is generated by one means or another, and this impulse is applied to the counter. The electrical side of the instrument consists of a number of so-called "flip-flop" circuits which react to the applied impulses and enable them to be registered in the manner described in the following paragraphs.

An example of a circuit of this kind, for which the ECC 40 is particularly suitable, is shown in Fig. 10. The action is as follows: The grid voltages of the triode sections I and II both comprise two components, viz. a negative voltage produced by the common cathode resistor R_k , and a positive voltage across the grid leaks R_g and R_g' . These grid leaks form part of the potentiometers R_3, R_a', R_1, R_g and R_3, R_a, R_2, R_g' .

Assume that at a given moment the grid of section II is positive with respect to the cathode. The anode current then flowing through R_a' and R_3 ensures that the voltage at point B, and therefore also that across R_g , remains low. As a result, the grid of section I becomes strongly negative with respect to the cathode, and the triode is thus biased to cut-off. Under these conditions the circuit is stable and will remain so until a sufficiently strong negative voltage impulse is applied to the input C_1 . When the impulse arrives, the electrical charge on C_1 increases and some of the electrons released from the

ECC 40

right-hand electrode of this capacitor as seen in the diagram pass through R_a , R_2 and R_g' , producing a drop in the voltage across R_g' and also reducing the anode current of section II to zero. Meanwhile, the voltage at B increases (as well as that across R_g), with the result that anode current flows in section I. The final outcome is that section I passes current whilst section II is quenched; in other words, the working conditions of the triodes I and II are reversed and this condition prevails until the next negative impulse again reverses the situation. In this case, however, the voltage at B drops suddenly, so that a negative impulse reaches the capacitor C_4 and is used to operate the next "flip-flop" circuit.

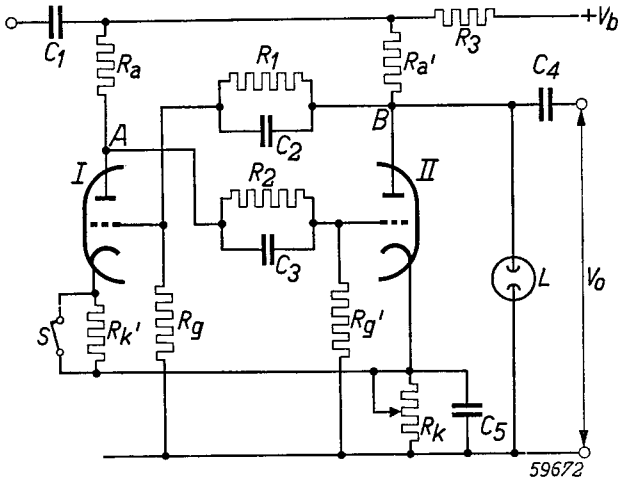
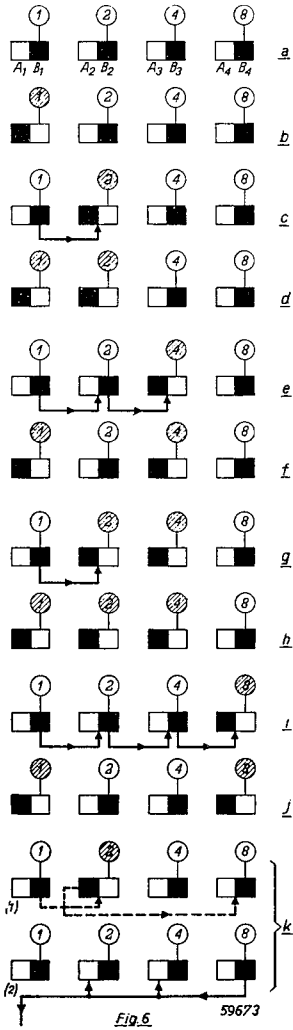

Fig. 10

The ECC 40 in a "flip-flop" circuit as used in electronic counters. $R_a=R_a'=22$ k Ω ; $R_1=R_2=0.1$ M Ω ; $R_3=10$ k Ω ; $R_g=R_g'=47$ k Ω ; $R_k=\text{max. } 6$ k Ω ; $R_k'=47$ k Ω ; $C_1=390$ pF; $C_2=C_3=150$ pF; $C_4=120$ pF; $C_5=0.27$ μ F.

Some idea of the use of flip-flop circuits in a counter can be obtained from Fig. 11, which depicts various conditions in a set of four flip-flop circuits connected in series: the white panels represent triode systems which are not passing current, and the black panels those which are. When the first sections of a double triode become conductive, a number is illuminated by a neon tube (L in Fig. 10) connected in parallel with the second section: the number of the first flip-flop circuit is 1, that of the second 2; the third is numbered 4 and the fourth 8. In Fig. 11, the illuminated numbers are indicated by hatched lines.

When the first impulse is applied to the input, number 1 lights up (Fig. 11b), and with the second impulse number 2 (Fig. 11c); with the third impulse number 2 remains alight and 1 also appears (Fig. 11d), after which number 4 lights up (Fig. 11e), etc. At the ninth impulse the numbers 8 and 1 are both illuminated (Fig. 11j); a subsequent impulse will not light up 8 and 2,



but, with a suitable circuit, will actuate the next set of four flip-flop circuits, of which the first triode then illuminates number 10 (Fig. 11k₂). The first four circuits are then restored to their original settings, ready to count the next ten impulses. It will be obvious that, to count a number embodying n figures, $4n$ flip-flop circuits will be required. In the circuit shown in Fig. 10, a biasing resistor R_k' is connected in the cathode circuit of section I; this resistor, shorted by switch S , serves to restore the circuit to neutral, for which purpose the switch is opened so as to increase the bias in section I to the point where it will pass no current. The original circuit is restored when switch S is closed, the instrument being ready to commence counting again.

Fig. 11
Four flip-flop circuits in series for counting from 1 up to 9. For explanation see text.

ECC 40

64166
ECC 40 22-π-50

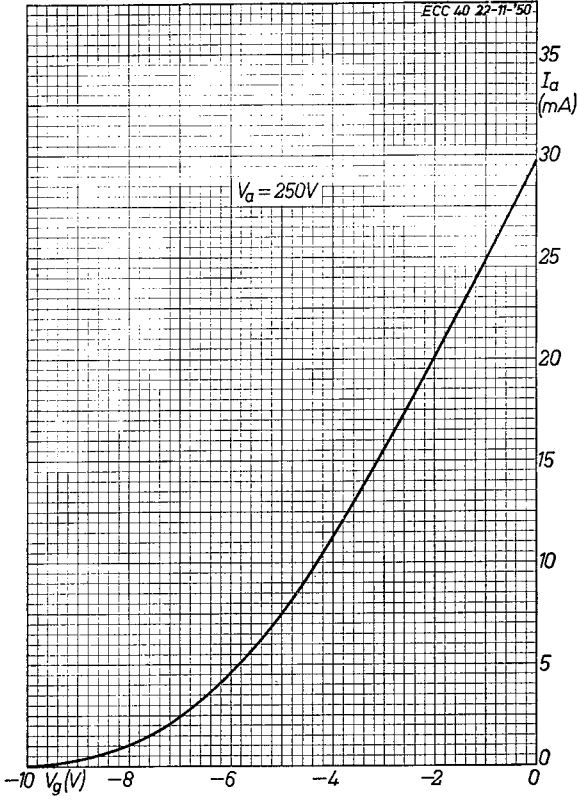
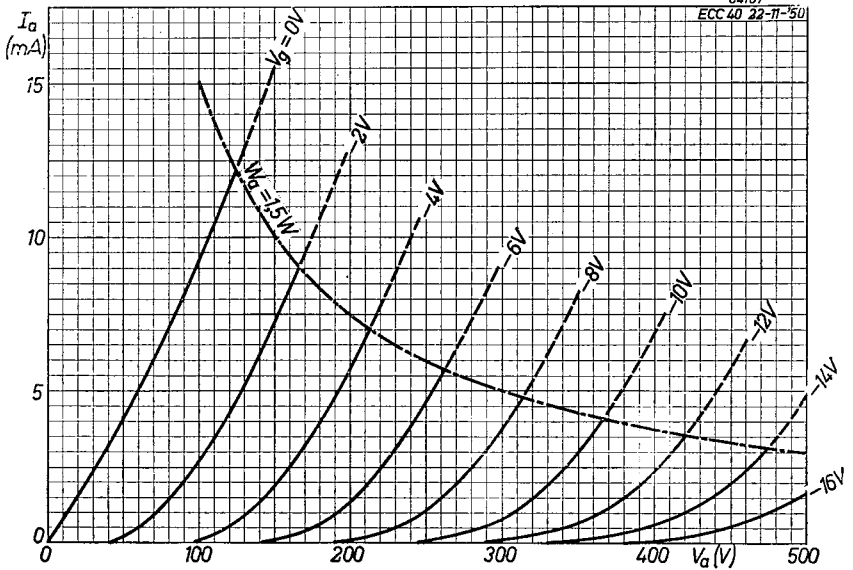

Fig. 12
 I_a/V_g characteristic of the
ECC 40 at an anode voltage
 $V_a = 250V$.

Fig. 13
 I_a/V_a characteristics of the
ECC 40. The dotted line
indicates the maximum per-
missible anode dissipation
 $W_a = 1.5W$.

64167
ECC 40 22-π-50



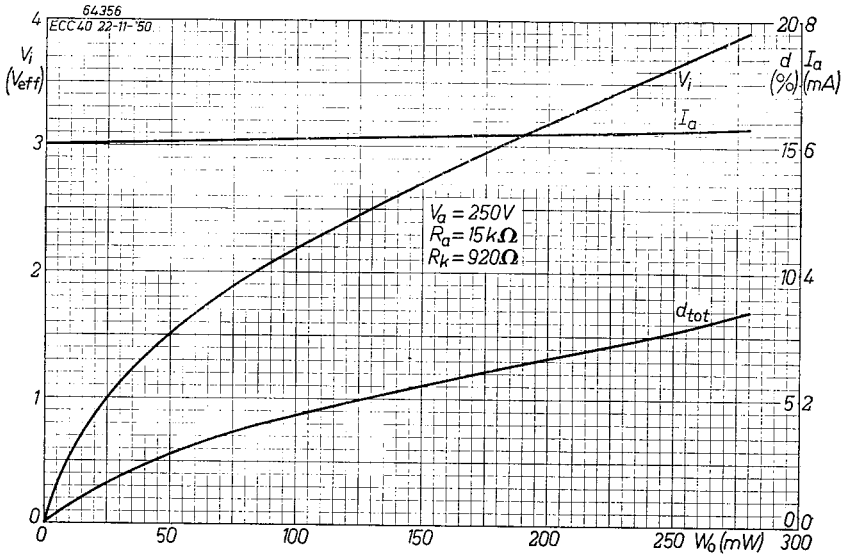

Fig. 14
Anode current I_a , required input voltage V_i and distortion d_{tot} of one triode section of the ECC 40 used as an output valve.

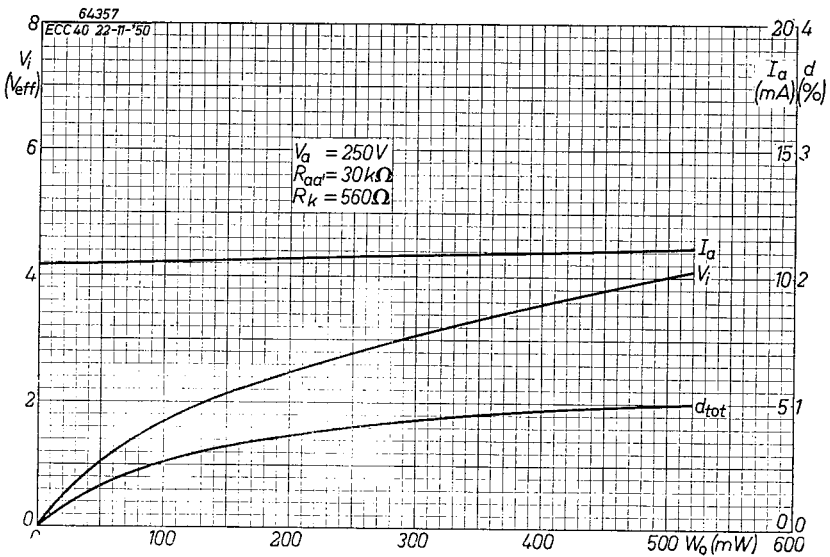

Fig. 15
As Fig. 14, for both sections of the ECC 40 connected in Class A push-pull.

EF 40

EF 40 A.F. pentode

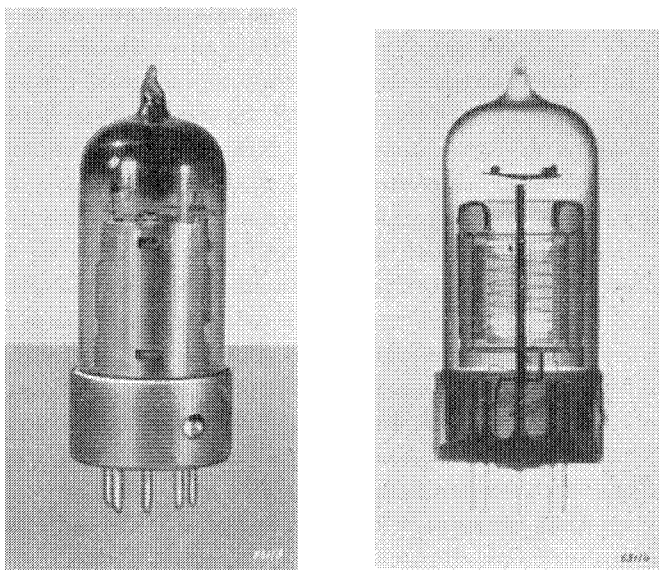

Fig. 1

Normal and X-ray photographs of the EF 40 (approximately actual size).

The EF 40 is an indirectly heated A.F. pentode with a straight characteristic and a slope of 1.85 mA/V. It is specially designed for A. F. amplification in high-sensitivity amplifiers and high-fidelity receivers; to this end, hum, valve noise and microphony have been reduced to the lowest possible level. The heater of the EF 40 can be either parallel or series fed, the heater current being 200 mA (A.C. or D.C.) at a voltage of 6.3 V.

A particularly rigid electrode system, incorporating twice the usual number of mica supports, is responsible for the pronounced reduction in microphony: to illustrate the gain obtainable without necessitating any special measures to avoid microphony, it may be said that, when the valve is used in an amplifier, the gain can be increased to a point at which the input required for maximum output power is not less than 5 mV. It is thereby assumed that the sound level in the region of the valve is the equivalent of that of a loud-speaker having an acoustic efficiency of 5%, and of which the input power is 5 W, located 10 cm from the valve.

In broadcast receivers, the maximum permissible amplification corresponds to an alternating input voltage of not less than 0.5 mV for an output of 50 mW, it being again assumed that the acoustic efficiency of the speaker is 5%, and the distance from the valve 10 cm. Comparison of the microphonic tendencies of the EF 40 with the EBC 41 (see page 58) shows that the above-

mentioned input of 0.5 mV becomes 10 mV in the case of the EBC 41, which clearly demonstrates the high quality of the EF 40.

As already mentioned in the description of the EAF 42, the above values are intended only as a general guide; certain effects, such as cabinet resonance, may render the valve microphonic at lower amplification levels.

If it is intended to increase the sensitivity of the EF 40 beyond the point that corresponds to the above values, measures to prevent microphony will probably prove necessary; for example, an anti-microphonic valveholder and/or an acoustic screen round the valve may have to be fitted. If the equipment is likely to be subjected to shocks or vibration, some form of anti-vibration mounting is definitely recommended for the valve.

In view of the fact that the EF 40 is also suitable for use as first valve in a microphone amplifier, every effort has been made to eliminate hum; the equivalent hum voltage on the control grid is accordingly less than $5 \mu\text{V}$, which means that the hum level is 60 db below the input signal required for the maximum output delivered by the output valve.

The main causes of hum include the magnetic field of the heater, leakage currents between the heater terminals and other electrodes, coupling between unscreened parts or the lead-in wires of the heater and other electrodes or lead-in wires, and emission from the extremities of the heater itself.

The effects of the magnetic field set up by the heater have already been discussed in the description of the EAF 42, where it appears that a straight characteristic is preferable to variable- μ conditions. To suppress this magnetic field as much as possible, the bifilar type of heater is used and the heater current is kept low (200 mA).

Leakage currents and coupling between heater and grid are minimized by keeping the connections to these electrodes as far apart as possible, and by providing appropriate screens in the valve. These also check emission from the ends of the heater and the consequent flow of electrons to other electrodes.

It is evident that in high-gain amplifiers certain precautions must be observed in connection with the circuit and wiring of the EF 40 in order to suppress hum; e.g. the valve should be placed as far as possible from transformers and chokes, to ensure that the stray fields of such components will not affect it. To avoid leakage currents in the valveholder, it is advisable to use one of good quality, and the Philips type 5904/03 is to be recommended.

Any residual hum can usually be reduced by connecting a wire-wound potentiometer of about 50 ohms in parallel with the heater, the sliding contact of the potentiometer being earthed and adjusted for minimum hum.

Further, to avoid hum due to coupling in the wiring, the heater contacts of the valveholder should be screened by a metal plate soldered to the central bush (see Fig. 2).

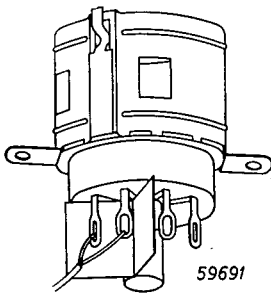

Fig. 2. Valveholder for the EF 40 with screening plate between contacts. This plate is soldered to the central bush.

EF 40

The central bush must be earthed, and it is advisable to use this as the central earthing point of the input circuit.
 The magnetic field of the heater leads can be reduced by twisting the leads.

TECHNICAL DATA OF THE A.F. PENTODE EF 40

Heater data

Heating: indirect, A.C. or D.C., series or parallel feed

Heater voltage	V_f	=	6.3 V
Heater current	I_f	=	0.2 A

Capacitances (cold valve)

Input capacitance	C_{g1}	=	4.5 pF
Output capacitance	C_a	=	5.2 pF
Between anode and control grid	C_{ag1}	<	0.04 pF
Between control grid and heater	C_{g1f}	<	0.002 pF

Typical characteristics

Anode voltage	V_a	=	250 V
Voltage, grid 3	V_{g3}	=	0 V
Screen grid voltage	V_{g2}	=	140 V
Grid bias	V_{g1}	=	-2 V
Anode current	I_a	=	3.0 mA
Screen grid current	I_{g2}	=	0.55 mA
Mutual conductance	S	=	1.85 mA/V
Internal resistance	R_i	=	2.5 MΩ
Amplification factor, grid 2 with respect to grid 1	μ_{g2g1}	=	38

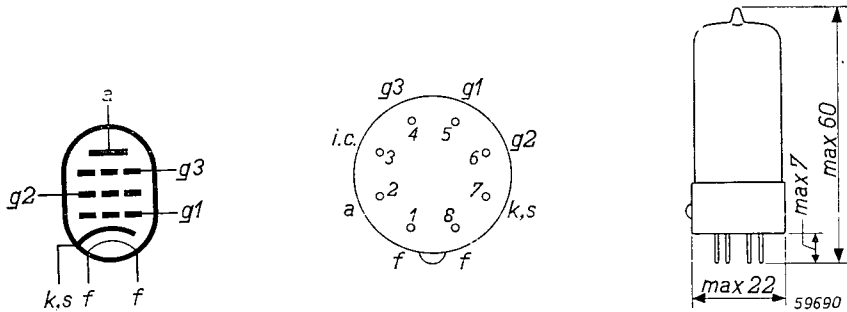

Fig. 3

Electrode arrangement, electrode connections and maximum dimensions in mm.

Operating characteristics of the EF 40 used as A.F. amplifier (see Fig. 4)

Supply voltage	V_b	= 250	250	100	100	V
Anode resistor	R_a	= 0.33	0.22	0.33	0.22	M Ω
Screen grid resistor	R_{g2}	= 1.5	1.0	1.2	1.0	M Ω
Grid leak	R_{g1}	= 1	1	1	1	M Ω
Grid leak of the next valve	R_{g1}'	= 1	1	1	1	M Ω
Cathode resistor	R_k	= 2.2	1.5	4.7	3.3	k Ω
Anode current	I_a	= 0.58	0.86	0.20	0.28	mA
Screen grid current	I_{g2}	= 0.12	0.18	0.05	0.06	mA
Amplification	V_o/V_i	= 210	180	125	120	
Distortion	$\left\{ \begin{array}{l} d_{tot}(V_o = 4 \text{ V}_{RMS}) \\ d_{tot}(V_o = 8 \text{ V}_{RMS}) \\ d_{tot}(V_o = 12 \text{ V}_{RMS}) \end{array} \right.$	= 0.6	0.5	1.1	1.1	%
		= 0.9	0.7	1.7	1.6	%
		= 1.2	1.0	2.6	2.5	%
Supply voltage	V_b	= 250	100	V		
Anode resistor	R_a	= 0.22	0.22	M Ω		
Screen grid resistor	R_{g2}	= 1.2	1.2	M Ω		
Grid leak	R_{g1}	= 10	10	M Ω		
Grid leak of the next valve	R_{g1}'	= 0.68	0.68	M Ω		
Cathode resistor	R_k	= 0	0	k Ω		
Anode current	I_a	= 0.9	0.3	mA		
Screen grid current	I_{g2}	= 0.17	0.06	mA		
Amplification	V_o/V_i	= 200	130			
Distortion	$\left\{ \begin{array}{l} d_{tot}(V_o = 4 \text{ V}_{RMS}) \\ d_{tot}(V_o = 8 \text{ V}_{RMS}) \\ d_{tot}(V_o = 12 \text{ V}_{RMS}) \end{array} \right.$	< 1	1.2	%		
		< 1	1.8	%		
		< 1	3.0	%		

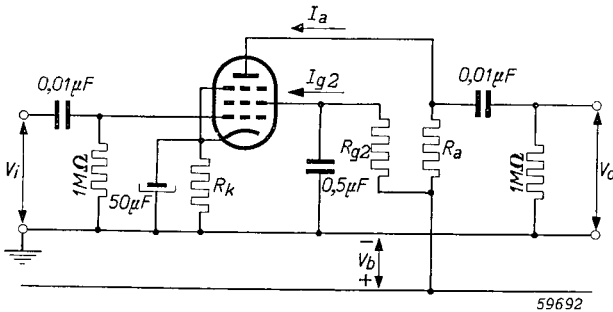

Fig. 4
The EF 40 used as A.F. amplifier.

Under the last-mentioned operating conditions the grid bias is obtained by means of the grid leak (the cathode resistor is omitted). The above data are valid when the internal resistance of the source of the input signal is zero; should this resistance be about 2 M Ω , the above values will still apply, except those of distortion, which are then increased by roughly 1%.

EF 40

In order to compute the alternating input voltage for this arrangement when the source of the input voltage possesses internal resistance, it should be noted that the input damping of the EF 40 under such operating conditions is about 6 MΩ

Operating characteristics of the EF 40 used as A.F. triode (screen grid connected to anode)

Supply voltage	V_b	=	250	250	100	100	V
Anode resistor	R_a	=	0.22	0.1	0.22	0.1	MΩ
Grid leak	R_{g1}	=	1	1	1	1	MΩ
Grid leak of the next valve	R_{g1}'	=	1	1	1	1	MΩ
Cathode resistor	R_k	=	1.8	1.2	4.7	2.7	kΩ
Anode current	I_a	=	0.84	1.5	0.27	0.47	mA
Amplification	V_o/V_i	=	31	29	27	26	
Distortion $d_{tot}(V_o=4 V_{RMS})$		=	0.6	0.6	1.0	1.0	%
Distortion $d_{tot}(V_o=8 V_{RMS})$		=	0.8	0.7	1.5	1.7	%
Distortion $d_{tot}(V_o=12 V_{RMS})$		=	1.1	1.0	1.8	2.2	%

Limiting values

Anode voltage, valve biased to cut-off	V_{a0}	= max.	550	V
Anode voltage	V_a	= max.	300	V
Anode dissipation	W_a	= max.	1	W
Screen grid voltage, valve biased to cut-off	V_{g20}	= max.	550	V
Screen grid voltage	V_{g2}	= max.	200	V
Screen grid dissipation	W_{g2}	= max.	0.2	W
Cathode current	I_k	= max.	6	mA
Grid current starting point	$V_{g1}(I_{g1}=+0.3\mu A)$	= max.	-1.3	V
External resistance between control grid and cathode	$R_{g1}(W_a < 0.2W)$	= max.	10	MΩ
External resistance between heater and cathode	$R_{g1}(W_a > 0.2W)$	= max.	3	MΩ ¹⁾
External resistance between heater and cathode	R_{fk}	= max.	20	kΩ
Voltage between heater and cathode	V_{fk}	= max.	100	V

¹⁾ If the grid bias is obtained only by means of the grid leak, the maximum value for R_{g1} is 22 MΩ.

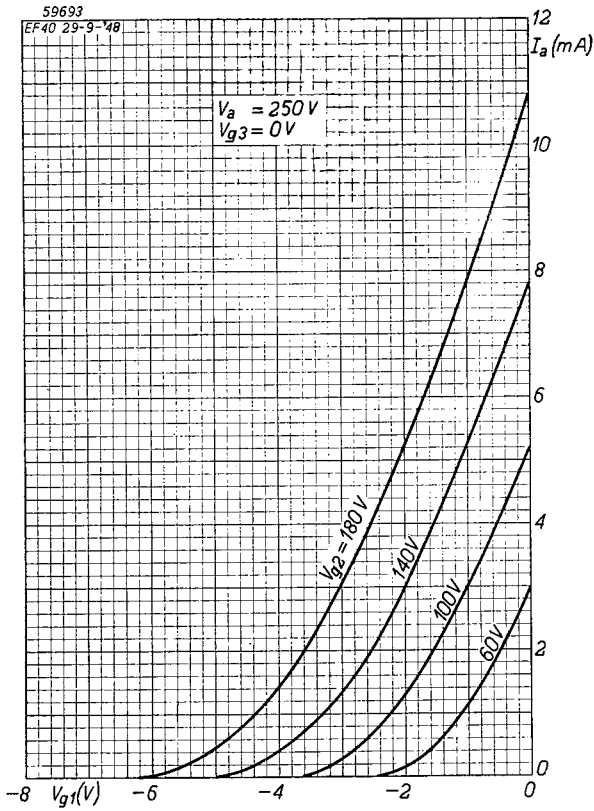

Fig. 5. Anode current (I_a) as a function of the grid bias (V_{g1}), at different screen grid voltages (V_{g2}). Anode voltage (V_a) = 250V.

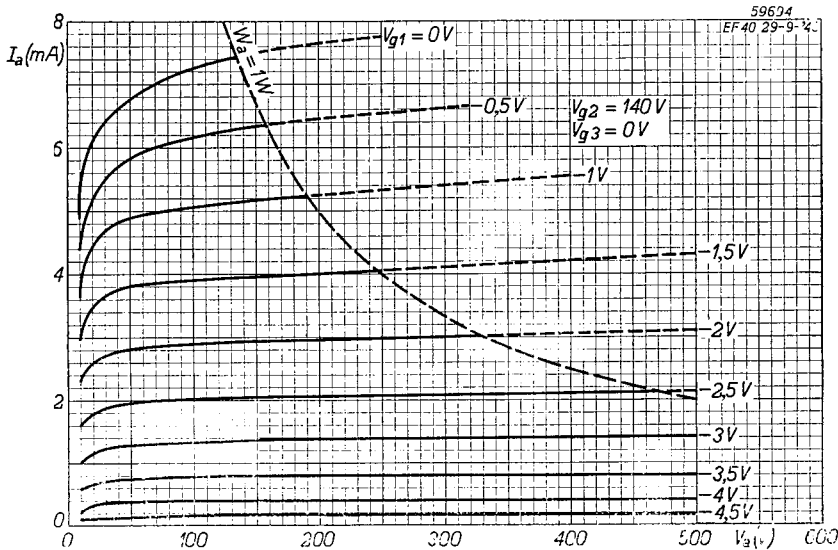

Fig. 6. Anode current (I_a), as a function of the anode voltage (V_a), at different values of the grid bias (V_{g1}). Screen grid voltage (V_{g2}) = 140 V. The broken line indicates the maximum permissible anode dissipation ($W_a = 1W$).

EF 42

EF 42 R.F. pentode with high mutual conductance

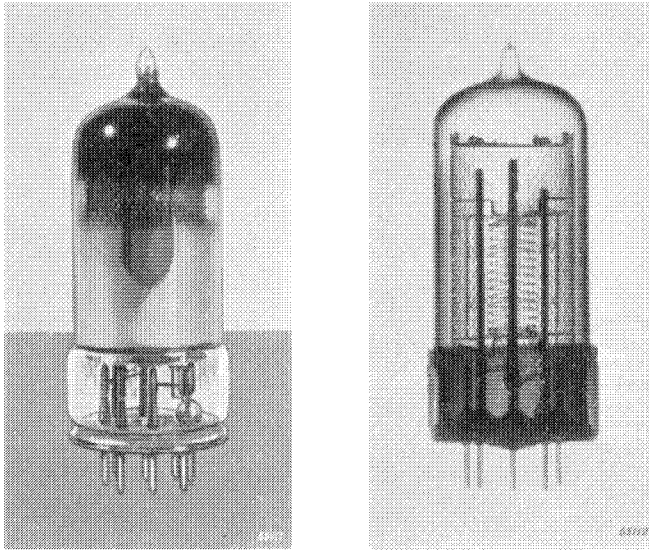

Fig. 1

Normal and X-ray photographs of the EF 42 (approximately actual size).

The EF 42 is an indirectly heated R.F. pentode with a slope of 9 mA/V at an anode current of 10 mA. Notwithstanding this high mutual conductance, the inter-electrode capacitances are small (input capacitance 9.4 pF, output capacitance 4.3 pF), for which reason the valve is an excellent wide-band amplifier for high frequencies (up to approx. 200 Mc/s). The EF 42 can also be used as a mixing valve, again at high frequencies; compared with triode-hexodes and triode-heptodes suitable for lower frequencies, this pentode has the advantages of higher conversion gain, less noise and less trouble from transit-time effects. It is even possible to use the EF 42 as a self-oscillating frequency changer, the oscillator frequency shift that accompanies any adjustment in the R.F. input circuit being reduced to negligible proportions by means of a special circuit described in a later paragraph. In the circuit in question the conversion conductance of the EF 42 is 3—4 mA/V, with an equivalent noise resistance of 3—5 k Ω .

Besides the uses already described, in view of its high mutual conductance the EF 42 is very suitable for various other purposes, such as in saw-tooth generators (as a transitron) and in cathode followers. For the latter a low output impedance is essential, and in the case of the EF 42 this is only about 100 ohms.

For use in such special circuits it is a great advantage that all the electrodes of the EF 42 are connected to separate pins.
 The entire electrode system of the valve is enclosed by an internal screen which is connected to a separate pin, thus obviating the need for external screening.

TECHNICAL DATA OF THE EF 42

Heater data

Heating: indirect, A.C. or D.C., parallel feed

Heater voltage	V_f	=	6.3 V
Heater current	I_f	=	0.33 A

Capacitances (cold valve)

Input capacitance	C_{g1}	=	9.4 pF
Output capacitance	C_a	=	4.3 pF
Between anode and control grid	C_{ag1}	<	0.006 pF
Between control grid and heater	C_{gf}	<	0.2 pF

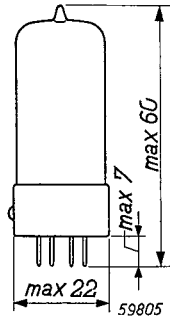
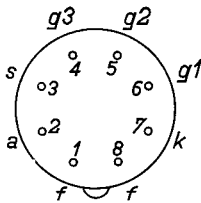
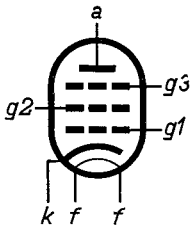

Fig. 2

Electrode arrangement, electrode connections and dimensions in mm of the EF 42.

Typical characteristics

Anode voltage	V_a	=	250 V
Voltage, grid 3	V_{g3}	=	0 V
Screen grid voltage	V_{g2}	=	250 V
Grid bias	V_{g1}	=	-2 V
Anode current	I_a	=	10 mA
Screen grid current	I_{g2}	=	2.4 mA
Mutual conductance	S	=	9 mA/V
Internal resistance	R_i	=	0.5 MΩ
Amplification factor, grid 2 with respect to grid 1	μ_{g2g1}	=	83
Equivalent noise resistance	R_{cq}	=	840 Ω

EF 42

Operating characteristics of the EF 42 used as R.F. amplifier

Anode voltage	V_a	=	250 V
Voltage, grid 3	V_{g3}	=	0 V
Screen grid voltage	V_{g2}	=	250 V
Anode current	I_a	=	10 mA
Frequency	f	=	100 Mc/s
Bandwidth	Δf	=	0.8 Mc/s
Power gain	G	=	1100

Limiting values

Anode voltage, valve biased to cut-off	V_{a_o}	= max.	550 V
Anode voltage	V_a	= max.	300 V
Anode dissipation	W_a	= max.	3.5 W
Screen grid voltage, valve biased to cut-off	V_{g2_o}	= max.	550 V
Screen grid voltage	V_{g2}	= max.	300 V
Screen grid dissipation	W_{g2}	= max.	0.7 W
Cathode current	I_k	= max.	25 mA
Grid bias	$-V_{g1}$	= max.	100 V
Grid current starting point	$V_{g1}(I_{g1} = +0.3\mu A)$	= max.	-1.3 V
External resistance between control grid and cathode	R_{g1}	= max.	1 M Ω ¹⁾
External resistance between heater and cathode	R_{fk}	= max.	20 k Ω
Voltage between heater and cathode	V_{fk}	= max.	100 V

The EF 42 used as a self-oscillating frequency changer at high frequencies

Fig. 3 shows the cathode and the first and second grids of the EF 42 connected as a Colpitts oscillator. The tuned circuit is formed by the coil L_1

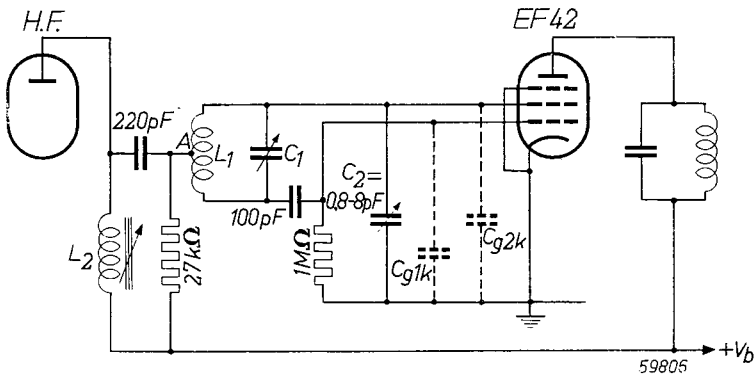

Fig. 3

¹⁾ With automatic grid bias.

and capacitor C_1 , in conjunction with the inter-electrode capacitances C_{g1k} and C_{g2k} . The two last-named capacitances virtually constitute a capacitive voltage divider, so that the cathode is connected to a tapping in the tuned circuit. At a point A on coil L_1 , the oscillator voltage with respect to the cathode is practically zero, the actual location of this point being dependent on the magnitude of C_{g1k} and C_{g2k} . With the aid of the trimmer C_2 in parallel with C_{g2k} , the point A can be made to coincide with a tapping taken from the same coil. Now, since there is practically no oscillator voltage between this tapping and the cathode, the output of an R.F. amplifier can be connected across these points without noticeably affecting the oscillator. Furthermore, the oscillator frequency will then undergo only the slightest displacement when the R.F. amplifier is tuned.

If the oscillator frequency exceeds the frequency of the R.F. signals, capacitive impedance to this R.F. signal occurs between point A and the cathode. By means of the adjustable coil L_2 in the anode circuit of the R.F. amplifier, this capacitance can be brought into series resonance with the self-inductance of L_2 . For an R.F. signal of 60 Mc/s, with an intermediate frequency of 26 Mc/s, it is thus possible to obtain an amplification of from 75 to 90 between the control grid of the R.F. amplifying valve and that of the first I.F. valve, with a bandwidth of 3.5 Mc/s.

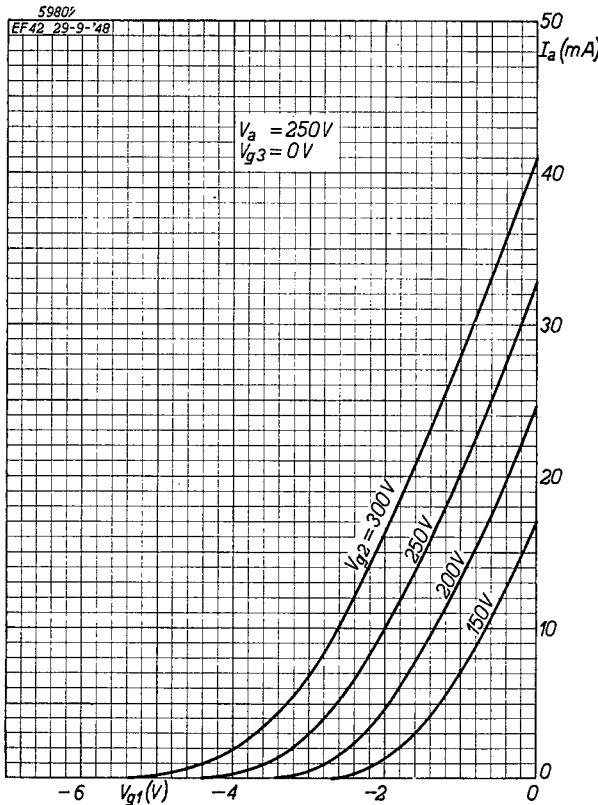

Fig. 4
 I_a/V_{g1} characteristics of
the EF 42.

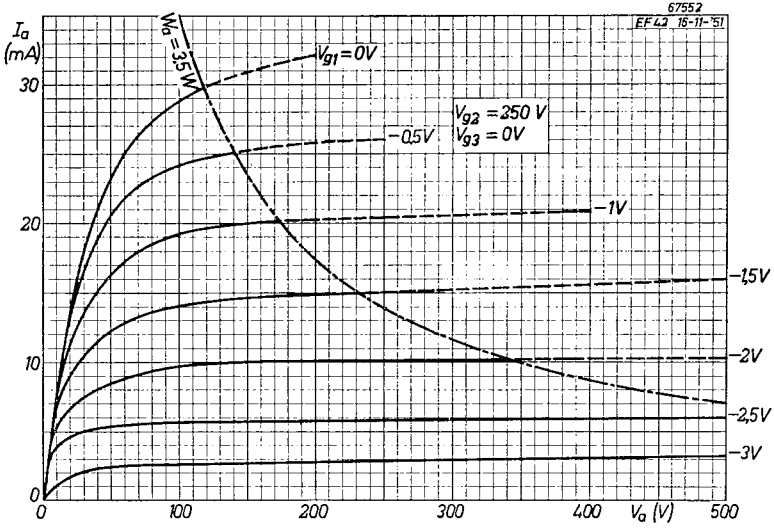

Fig. 5
 I_a/V_a characteristics of the EF 42. The broken line indicates the maximum permissible anode dissipation ($W_a = 3.5 W$).

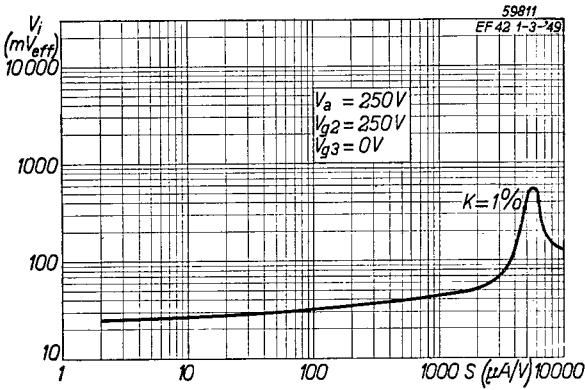

Fig. 6
The effective voltage (V_i) of an interfering signal at the control grid, producing 1% cross-modulation, as a function of the mutual conductance.

UF 42 R.F. pentode

The UF 42 is an R.F. pentode with a very high mutual conductance, namely 8 mA/V. Amongst other applications, it is intended for use as a wide-band amplifier. The heater of this valve can be run in a 100 mA series chain. In all other respects, this valve is identical with the EF 42, and full particulars will be found in the description of the latter.

TECHNICAL DATA OF THE R.F. PENTODE UF 42

Heater data

Heating: indirect, A.C. or D.C., series feed

Heater current	I_f	=	100 mA
Heater voltage	V_f	=	21 V

Capacitances (cold valve)

Input capacitance	C_{g1}	=	8.6 pF
Output capacitance	C_a	=	4.3 pF
Between anode and control grid	C_{ag1}	<	0.006 pF
Between control grid and heater	C_{g1f}	<	0.2 pF

Typical characteristics

Anode voltage	V_a	=	170 V
Voltage, grid 3	V_{g3}	=	0 V
Screen grid voltage	V_{g2}	=	170 V
Grid bias	V_{g1}	=	-2 V
Anode current	I_a	=	10 mA
Screen grid current	I_{g2}	=	2.8 mA
Mutual conductance	S	=	8 mA/V
Internal resistance	R_i	=	0.3 M Ω
Amplification factor, grid 2 with respect to grid 1	μ_{g2g1}	=	52
Equivalent noise resistance	R_{eq}	=	1060 Ω

Operating characteristics of the UF 42 as R.F. amplifier

Anode voltage	V_a	=	170 V
Voltage, grid 3	V_{g3}	=	0 V
Screen grid voltage	V_{g2}	=	170 V
Anode current	I_a	=	10 mA
Frequency	f	=	100 Mc/s
Bandwidth	Δf	=	0.8 Mc/s
Power gain	G	=	1000

UF 42

Limiting values

Anode voltage, valve biased to cut-off	V_{a_c}	= max. 550 V
Anode voltage	V_a	= max. 250 V
Anode dissipation	W_a	= max. 2 W
Screen grid voltage, valve biased to cut-off	V_{g2_c}	= max. 550 V
Screen grid voltage	V_{g2}	= max. 250 V
Screen grid dissipation	W_{g2}	= max. 0.5 W
Cathode current	I_k	= max. 15 mA
Grid bias	$-V_{g1}$	= max. 100 V
Grid current starting point	$V_{g1}(I_{g1} = +0.3 \mu A)$	= max. -1.3 V
External resistance between control grid and cathode	R_{g1}	= max. 1 MΩ ¹⁾
Voltage between heater and cathode	V_{fk}	= max. 150 V
External resistance between heater and cathode	R_{fk}	= max. 20 kΩ

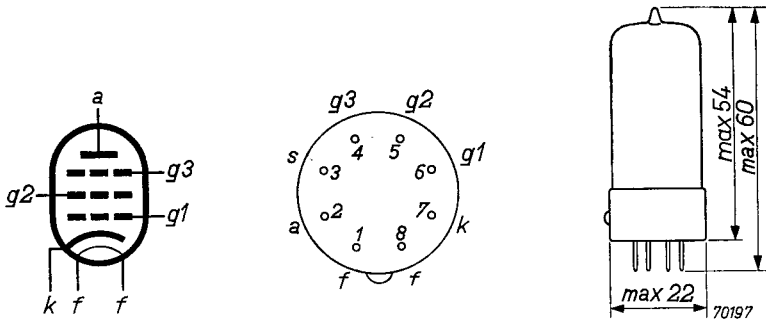

Fig. 1

Electrode arrangement, electrode connections and dimensions in mm of the UF 42.

1) With automatic grid bias.

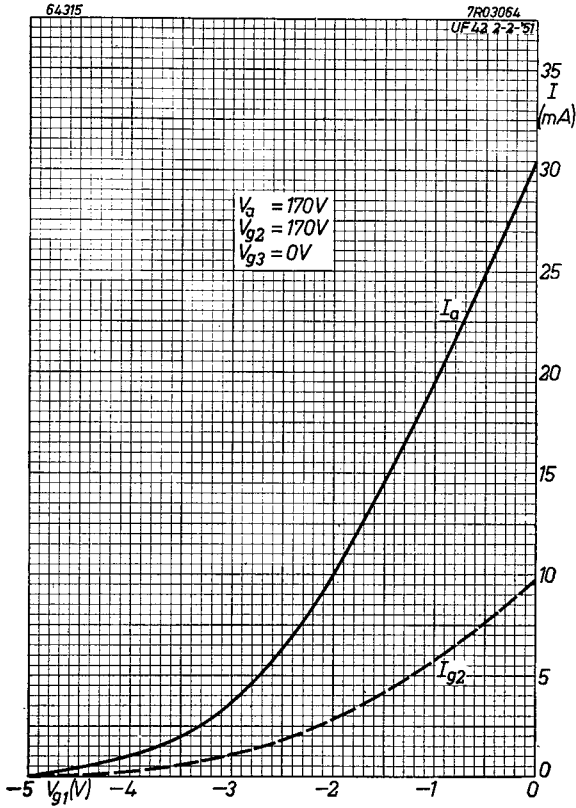

Fig. 2
 I_a/V_{g1} characteristics of
the UF 42.

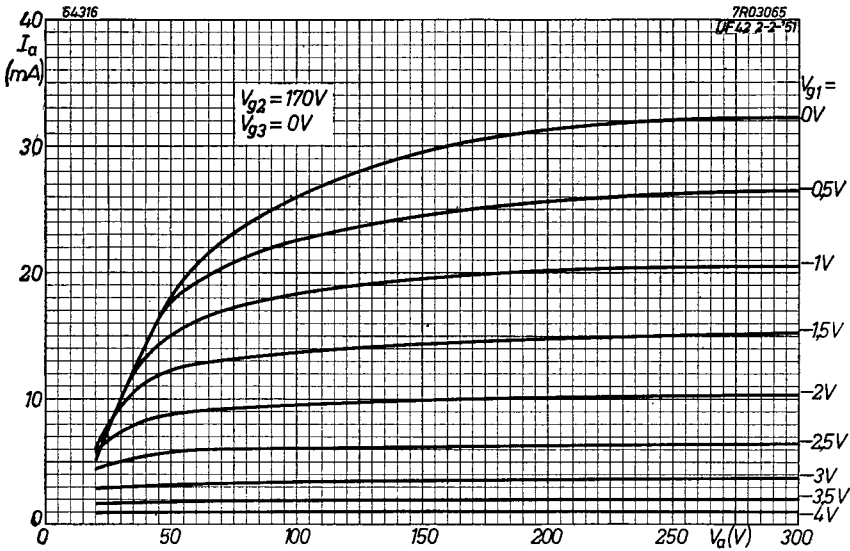

Fig. 3
 I_a/V_a characteristics of
the UF 42.

XI. A 10 W amplifier with two Rimlock valves EL 41 in Class AB push-pull

Introduction

This 10 W amplifier employs only Rimlock valves, viz.

EF 40 — pre-amplifier,

ECC 40 — second pre-amplifier and phase inverter,

2 × EL 41 — Class AB push-pull amplifier,

EZ 40 — rectifying valve.

An input of only 25 mV_{RMS} is required for the maximum output of 10 W to the speaker

Description of the circuit

The A.F. pentode EF 40 is used as first pre-amplifier, this valve ensuring very low hum and noise levels. For bass and treble response control, two potentiometers, P_2 and P_3 , are connected in the anode circuit, the volume being controlled by means of potentiometer P_1 across the input of the amplifier. Next in sequence to the EF 40 is the double triode ECC 40, of which section I serves as an A.F. amplifier. As part of the output voltage is fed back onto the cathode resistor R_7 (no decoupling capacitor), the overall amplification from the control grid of the ECC 40 is reduced by a factor of 2, and the distortion is thereby also reduced.

Section II of the double triode is used as a phase inverter for the alternating anode voltage of section I. In view of the fact that an amplification of only 1 is needed, considerable feedback is returned through the resistor R_8 .

The two A.F. voltages from the ECC 40, with 180° phase difference, are supplied via C_6 and C_7 to the control grids of the output valves EL 41. These are in Class AB push-pull and capable of delivering 13 W output with 2.5% distortion for 300 V on the anodes and screen grids.

The output transformer should be designed for a primary matching impedance of 9000 ohms.

For rectification of the A.C. mains, the full-wave rectifying valve EZ 40 is employed, hum being avoided by extra smoothing of the supply voltages for the EF 40 and ECC 40. As a further precaution against hum, the centre-tap of the heater winding for these valves is connected to the cathodes of the EL 41's, so that the heater of the EF 40 is at a positive potential with respect to the control grid.

Cathode current of the EL 41's for a supply voltage of 300 V

Without signal
2 × 35 mA

At max. output power
2 × 46 mA

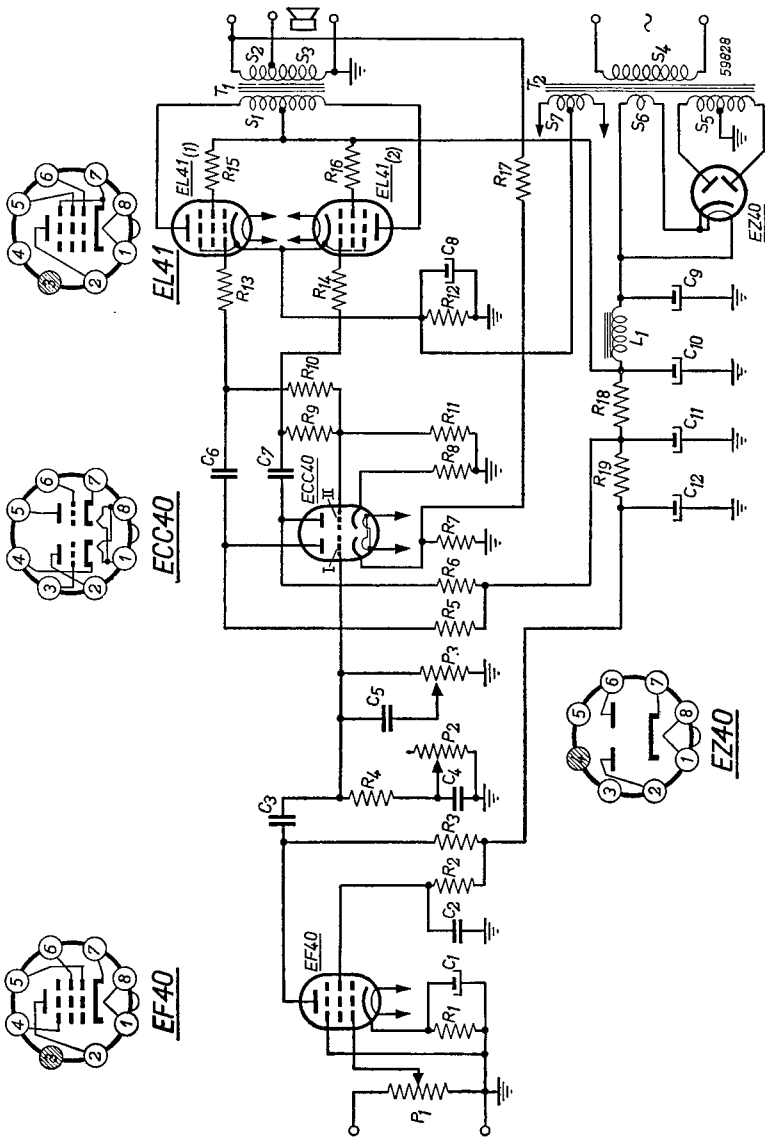

Fig. 1
 A 10-W amplifier with two Rimlock output valves EL 41 in Class AB push-pull.

Details of the mains transformer T₂

Winding	Voltage	Current
<i>S</i> ₄	220 V	50 c/s
<i>S</i> ₅	2 × 300 V	<i>R</i> _{<i>t min</i>} = 215 Ω per anode
<i>S</i> ₆	6.3 V	0.6 A
<i>S</i> ₇	2 × 3.15 V	2.2 A

Resistors

<i>R</i> ₁	=	4.7	kΩ	—	0.25	W
<i>R</i> ₂	=	1.8	MΩ	—	0.25	W
<i>R</i> ₃	=	0.47	MΩ	—	0.25	W
<i>R</i> ₄	=	0.1	MΩ	—	0.25	W
<i>R</i> ₅	=	0.1	MΩ	—	0.5	W
<i>R</i> ₆	=	0.1	MΩ	—	0.5	W
<i>R</i> ₇	=	2.2	kΩ	—	0.25	W
<i>R</i> ₈	=	2.2	kΩ	—	0.25	W
<i>R</i> ₉	=	0.27	MΩ	—	0.25	W
<i>R</i> ₁₀	=	0.22	MΩ	—	0.25	W
<i>R</i> ₁₁	=	0.22	MΩ	—	0.25	W
<i>R</i> ₁₂	=	140	Ω	—	2	W
<i>R</i> ₁₃	=	1	kΩ	—	0.25	W
<i>R</i> ₁₄	=	1	kΩ	—	0.25	W
<i>R</i> ₁₅	=	47	Ω	—	0.25	W
<i>R</i> ₁₆	=	47	Ω	—	0.25	W
<i>R</i> ₁₇	=	27	kΩ	—	0.25	W
<i>R</i> ₁₈	=	10	kΩ	—	0.25	W
<i>R</i> ₁₉	=	47	kΩ	—	0.25	W

Potentiometers

<i>P</i> ₁	=	0.5	MΩ	(logarithmic)
<i>P</i> ₂	=	2	MΩ	(linear)
<i>P</i> ₃	=	2	MΩ	(linear)

Capacitors

<i>C</i> ₁	=	100	μF	—	8	V
<i>C</i> ₂	=	47,000	pF			
<i>C</i> ₃	=	22,000	pF			
<i>C</i> ₄	=	4700	pF			
<i>C</i> ₅	=	2200	pF			
<i>C</i> ₆	=	22,000	pF			
<i>C</i> ₇	=	22,000	pF			
<i>C</i> ₈	=	50	μF	—	25	V
<i>C</i> ₉	=	25	μF	—	500	V
<i>C</i> ₁₀	=	25	μF	—	500	V
<i>C</i> ₁₁	=	12.5	μF	—	355	V
<i>C</i> ₁₂	=	12.5	μF	—	355	V

Coils

<i>L</i> ₁	=	10	H	(75 mA — 200 Ω)
-----------------------	---	----	---	--------------------

"Miniwatt" miniature valves

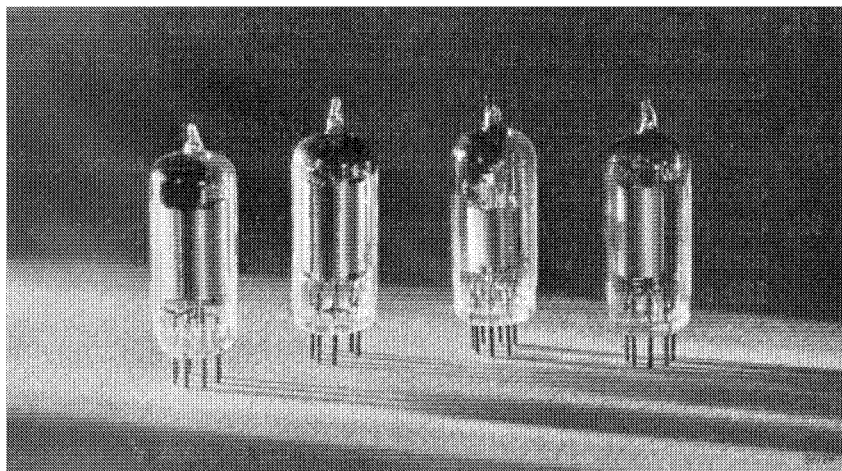

Fig. 1
Miniature battery valves.

In the introduction to the section on Rimlock battery valves, page 270, attention is drawn to the fact that battery receivers fall into two different categories, each making its own special demands on the valve. The possibility of establishing a suitable range of valves for the different types of receiver has been increased considerably by the introduction of a complete set of 7-pin miniature valves to supplement the Rimlock range. Since the miniature valves differ in several respects from the Rimlock types, a brief description may be given here.

Both Rimlock and miniature valves are of an all-glass pattern, but the latter have only seven pins. These pins are located at seven points of an octagon, leaving one point vacant, so that no additional locating device, like that in the Rimlock valves, is needed to guide the valve into the holder. Miniature valves are slightly smaller than the Rimlock types, the maximum overall diameter being only 19 mm as compared with the 22 mm diameter of the latter. Miniature valves are therefore ideal for use in small portable sets.

The miniature valve range comprises four types, viz.

DK 91, a heptode suitable for use as a self-oscillating frequency changer, with a conversion conductance of $280 \mu\text{A}/\text{V}$ at its working point;

DF 91, an R.F. pentode with a slope of approx. $0.9 \text{ mA}/\text{V}$;

DAF 91, a diode-A.F. pentode from which a gain of about 70 may be obtained;

DL 92, an output pentode capable of delivering 270 mW output at an anode voltage of 90 V, or 180 mW at 67.5 V.

The nominal filament voltage for these valves is 1.4 V when they are connected in parallel, the total filament current being 250 mA. When the filaments are series-connected, the current is 50 mA for a total voltage of about 7 V. It is generally advisable to limit the filament voltage to nominal 1.3 V per valve (2.6 V in the case of the DL 92) when using a series-connection, to allow for fluctuations in the line voltage. The reason for this will be found in the introduction to the Rimlock range.

In general, as applies to all miniature valves, it should be noted that the valve must be withdrawn quite vertically from its holder. Any side to side motion will impart lateral thrust to the pins, and this is liable to crack the glass base. Moreover, when the wiring is connected to the valveholder, care should be taken that the contacts are not pulled to one side, as this may cause the pins to be bent, or the base to be cracked, when the valve is inserted.

DAF 91 Diode - A.F. pentode battery valve

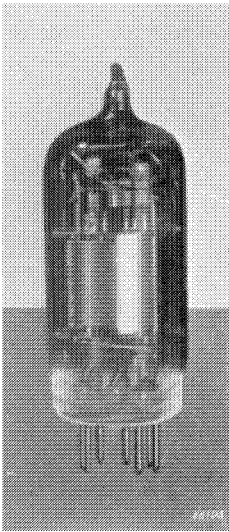

Fig. 1
The DAF 91 (approximately full size).

The DAF 91 is a diode-pentode battery valve. The pentode section is suitable for A.F. amplification, the diode being then used for detection or A.G.C.

The voltage amplification obtainable from the pentode section is approximately 45 at 45 V, 60 at 67.5 V, or 75 at 90 V.

When connected as a triode, the voltage amplification of the valve is 11.

The nominal filament voltage is 1.4 V with a filament current of 50 mA.

When the filament is connected in series with other valves, the filament voltage should be reduced to 1.3 V; this will ensure that no overloading takes place in the event of voltage fluctuations. If necessary, a resistor may be connected in parallel with the filament, to provide a shunt for the cathode current from other valves.

The properties of the valve from the point of view of microphony may be defined by stating that it is not usually necessary to take measures to prevent microphony when the input signal for the DAF 91 is not less than 40 mV when the output valve delivers 50 mW to a 5% efficient loudspeaker.

The significance of this value is fully explained in the chapters dealing with the EAF 42 and EBC 41.

TECHNICAL DATA OF THE DIODE-A.F. PENTODE DAF 91

Filament data

Heating: direct from battery, rectified A.C., or D.C.; series or parallel feed

In parallel with other valves

Filament voltage	V_f	=	1.4 V
Filament current	I_f	=	50 mA

In series with other valves

Filament voltage	V_f	=	1.3 V
----------------------------	-------	---	-------

Capacitances (valve cold)

Input capacitance	C_{g1}	=	2.0 pF
Output capacitance	C_a	=	2.8 pF
Between anode and control grid	C_{ag1}	<	0.4 pF
Between diode-anode and filament	C_d	=	1.5 pF

DAF 91

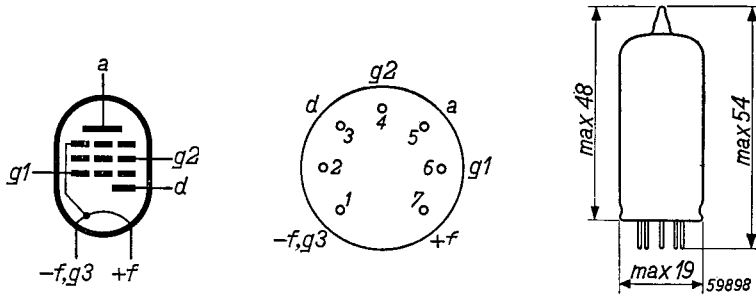

Fig. 2

Electrode arrangement, electrode connections and max. dimensions (in mm) of the DAF 91.

Typical characteristics

Anode voltage	V_a	= 67.5	90 V
Screen grid voltage	V_{g2}	= 67.5	90 V
Control grid voltage	V_{g1}	= 0	0 V
Anode current	I_a	= 1.6	2.7 mA
Screen grid current	I_{g2}	= 0.4	0.65 mA
Mutual conductance	S	= 625	720 $\mu\text{A/V}$
Internal resistance	R_i	= 0.6	0.5 $\text{M}\Omega$
Amplification factor: second grid with respect to first grid	μ_{g2g1}	= 13.5	13.5

Operating characteristics of the pentode section used as A.F. amplifier

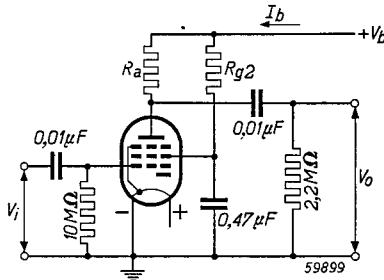

Fig. 3

The DAF 91 used as A.F. amplifier.

V_b (V)	R_a ($\text{M}\Omega$)	R_{g2} ($\text{M}\Omega$)	I_b (mA)	$\frac{V_o}{V_i}$	Distortion (%) at $V_o = 5 V_{\text{RMS}}$
45	1.0	3.3	0.05	45	2.0
67.5	1.0	3.3	0.075	60	3.0
90	1.0	3.3	0.10	67	5.0
45	1.0	4.7	0.045	44	4.5
67.5	1.0	4.7	0.065	62	2.0
90	1.0	4.7	0.09	75	2.0

Operating characteristics of the pentode section connected as A.F. amplifying triode (screen grid connected to anode)

See Fig. 3 for definitions of symbols.

V_b (V)	R_a (M Ω)	R_{g1} (M Ω)	$R_{g1}'^1$ (M Ω)	I_b (mA)	$\frac{V_o}{V_i}$	Distortion (%) at $V_o=5V_{RMS}$
90	0.22	10	0.68	0.25	11	1.0
90	0.47	10	1.5	0.13	11.6	0.8

1) R_{g1}' is the grid leak of the next valve.

Limiting values

Anode voltage	V_a	= max. 90 V
Anode dissipation	W_a	= max. 0.25 W
Screen grid voltage	V_{g2}	= max. 90 V
Screen grid dissipation	W_{g2}	= max. 0.06 W
Grid current starting point	$V_{g1}(I_{g1}=+0.3 \mu A)$	= max. -0.4 V
Cathode current	I_k	= max. 4.5 mA
External resistance between control grid and cathode	R_{g1}	= max. 3 M Ω 1)
Peak inverse voltage: diode-anode	$V_{d inv p}$	= max. 100 V
Diode current	I_d	= max. 0.2 mA
Diode peak current	I_{dp}	= max. 1.2 mA
Starting point of diode current	$V_d(I_d=+0.3 \mu A)$	= max. -0.4 V

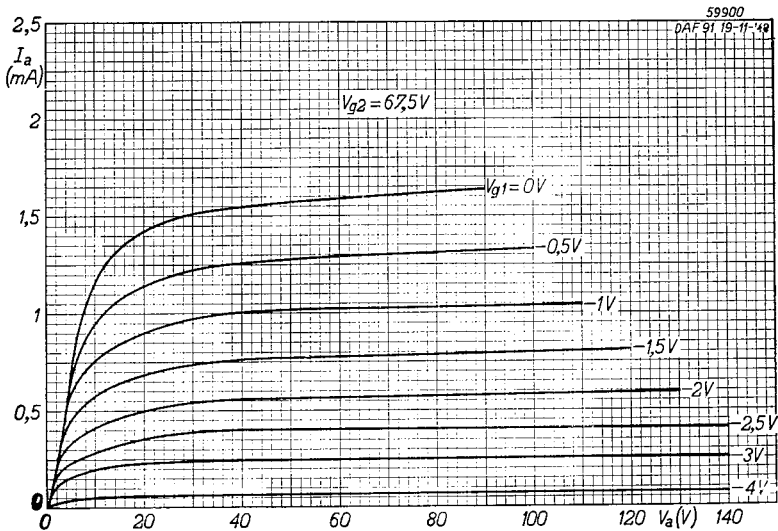

Fig. 4
 I_a/V_a characteristics for a screen grid voltage (V_{g2}) of 67.5 V.

1) With grid current biasing 22 M Ω .

DAF 91

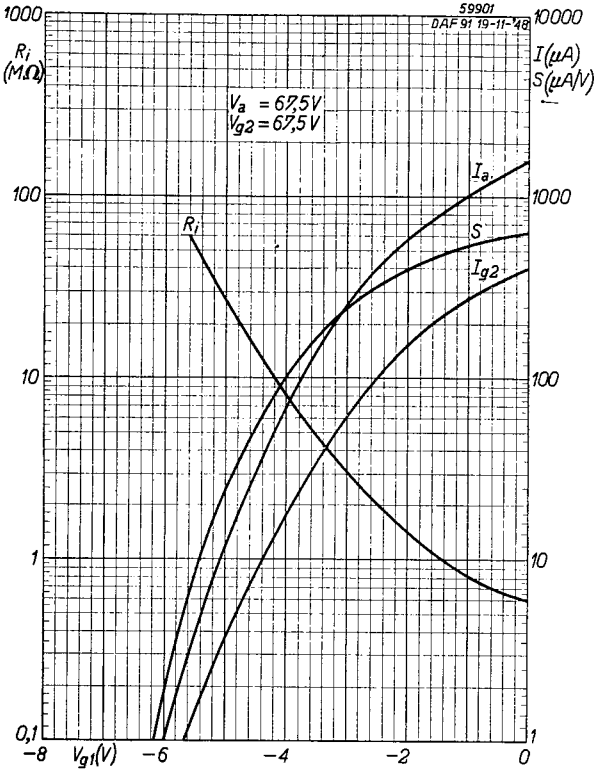

Fig. 5
Anode current (I_a), screen grid current (I_{g2}), mutual conductance (S) and internal resistance (R_i) as functions of the grid bias (V_{g1}) with anode and screen grid voltages (V_a and V_{g2}) of 67.5 V.

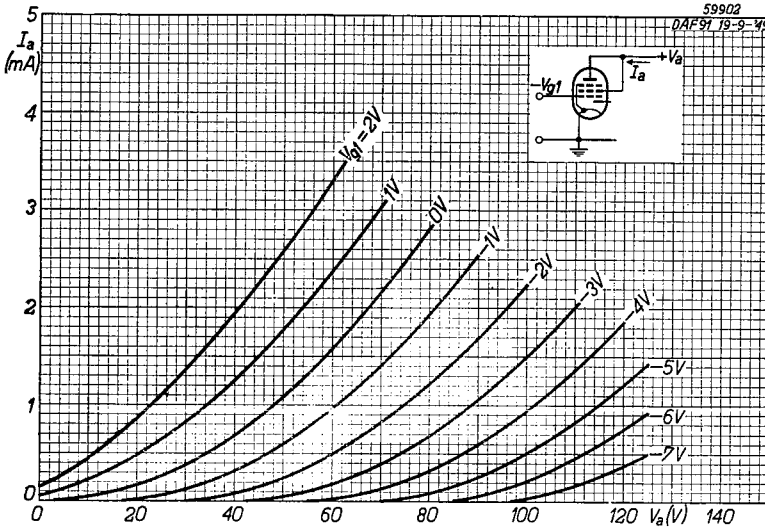

Fig. 6
 I_a/V_a characteristics of the DAF 91 connected as a triode

DF 91 Battery-type R.F. pentode

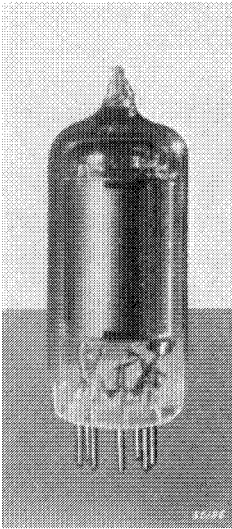

Fig. 1
The DF 91 (approximately full size).

The DF 91 is a pentode for use as R.F. or I.F. amplifier in battery sets. With 67.5 V on both anode and screen grid, the slope is 0.875 mA/V and the internal resistance 0.25 M Ω . If the anode voltage be increased to 90 V (67.5 V is the maximum permissible value for the screen grid) the slope and internal resistance are 0.9 mA/V and 0.5 M Ω , respectively; with 45 V on both anode and screen grid the slope is still 0.7 mA/V, the internal resistance being then 0.35 M Ω . The capacitance between anode and control grid is less than 0.01 pF.

The filament voltage of this valve is 1.4 V with a filament current of 50 mA; the filament is suitable for parallel as well as series feeding. Directions for series feeding are given in the description of the DAF 91.

The maximum permissible voltages for anode and screen grid are 90 V and 67.5 V, respectively.

The DF 91 is a variable-mu valve and, when control is applied simultaneously to the frequency changer DK 91, a suitable A.G.C. curve can be secured. A method of feeding the screen grids by means of a common resistor is described in the chapter dealing with the DK 91.

Anti-vibration mounting of the holder of the DF 91 is sometimes essential to prevent microphony, and it is usually necessary to provide a screening plate between the anode and control-grid pins, to ensure that the capacitance between these electrodes is not increased by the circuit capacitance.

TECHNICAL DATA OF THE R.F. PENTODE DF 91

Filament data

Heating: direct from battery, rectified A.C., or D.C.; series or parallel feed

In parallel with other valves

Filament voltage . . .	V_f	=	1.4 V
Filament current . . .	I_f	=	50 mA

In series with other valves

Filament voltage . . .	V_f	=	1.3 V
------------------------	-------	---	-------

DF 91

Capacitances (valve cold)

Input capacitance	C_{g1}	=	3.6 pF
Output capacitance	C_a	=	7.5 pF
Between anode and control grid	C_{ag1}	<	0.01 pF ¹⁾

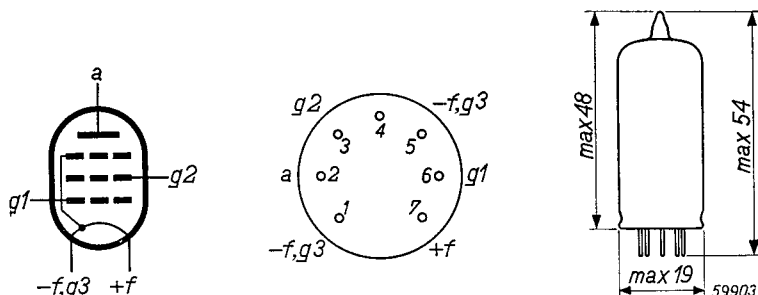

Fig. 2

Electrode arrangement, electrode connections and max. dimensions in mm.

Operating characteristics for use as R.F. or I.F. amplifier

Anode voltage	V_a	=	45	67.5	V
Screen grid voltage	V_{g2}	=	45	67.5	V
Control grid voltage	V_{g1}	=	0 —10	0 —16	V
Anode current	I_a	=	1.7 —	3.4 —	mA
Screen grid current	I_{g2}	=	0.7 —	1.5 —	mA
Mutual conductance	S	=	700 10	875 10	$\mu\text{A/V}$
Internal resistance	R_i	=	0.35 >10	0.25 >10	M Ω
Amplification factor: second grid with respect to first grid	μ_{g2g1}	=	11 —	11 —	
Equivalent noise resistance	R_{eq}	=	— —	20 —	k Ω
Anode voltage	V_a	=	90	90	V
Screen grid voltage	V_{g2}	=	45	67.5	V
Control grid voltage	V_{g1}	=	0 —10	0 —16	V
Anode current	I_a	=	1.8 —	3.5 —	mA
Screen grid current	I_{g2}	=	0.65 —	1.4 —	mA
Mutual conductance	S	=	750 10	900 10	$\mu\text{A/V}$
Internal resistance	R_i	=	0.8 >10	0.5 >10	M Ω
Amplification factor: second grid with respect to first grid	μ_{g2g1}	=	11 —	11 —	
Equivalent noise factor	R_{eq}	=	— —	19 —	k Ω

¹⁾ Measured with external screening.

Limiting values

Anode voltage	V_a	= max.	90 V
Anode dissipation	W_a	= max.	0.35 W
Screen grid voltage	V_{g^2}	= max.	67.5 V
Screen grid dissipation	W_{g^2}	= max.	0.11 W
Cathode current	I_k	= max.	5.5 mA
Grid current starting point	$V_{g1}(I_{g1} = +0.3\mu\text{A})$	= max.	-0.2 V
External resistance between control grid and cathode	R_{g1}	= max.	3 MΩ

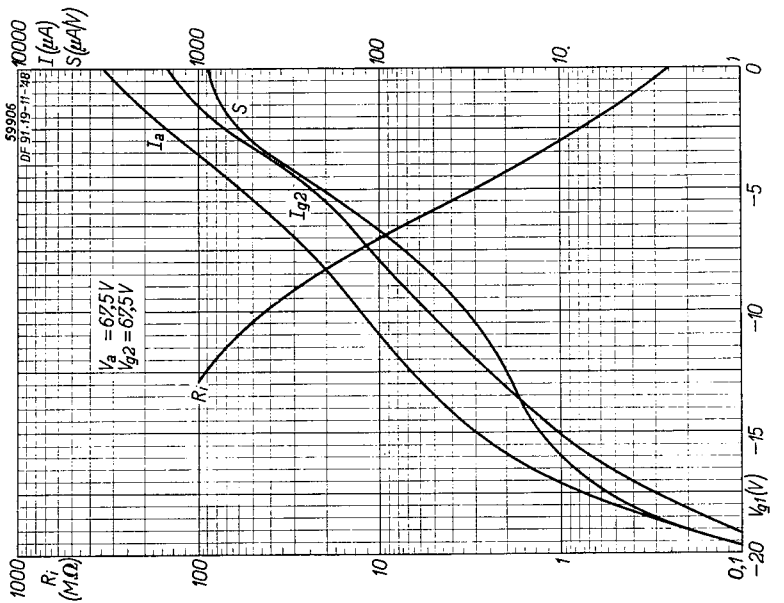

Fig. 3 Anode current (I_a), screen grid current (I_{sg2}), mutual conductance (S) and internal resistance (R_i) of the DF 91 as functions of the grid bias (V_{g1}). Fig. 3 for $V_a = V_{sg2} = 45\text{ V}$; Fig. 4 for $V_a = V_{sg2} = 67.5\text{ V}$.

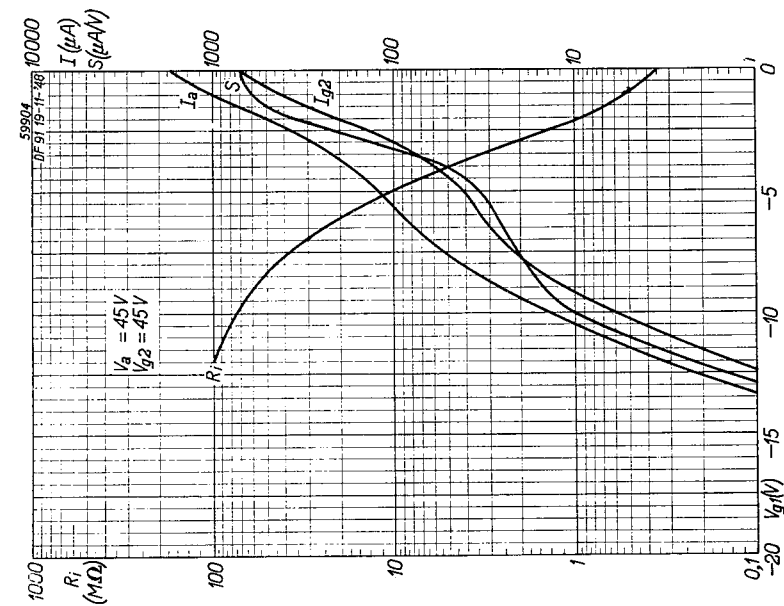

Fig. 4

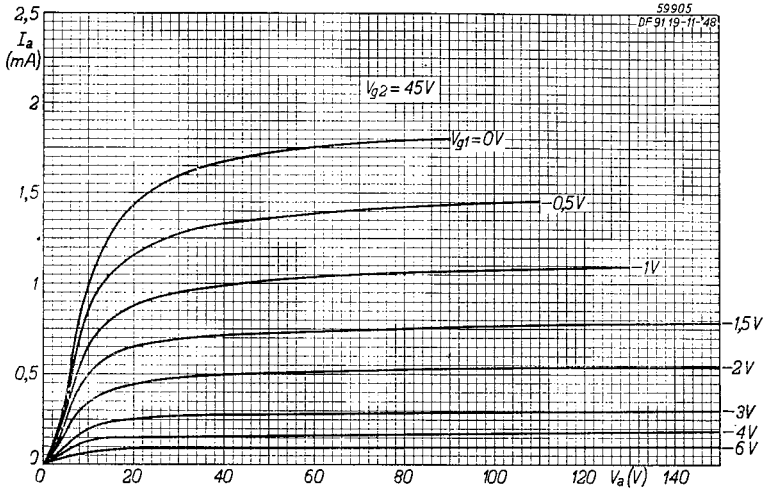

Fig. 5. I_a/V_a characteristics of the DF 91 with $V_{g2} = 45$ V.

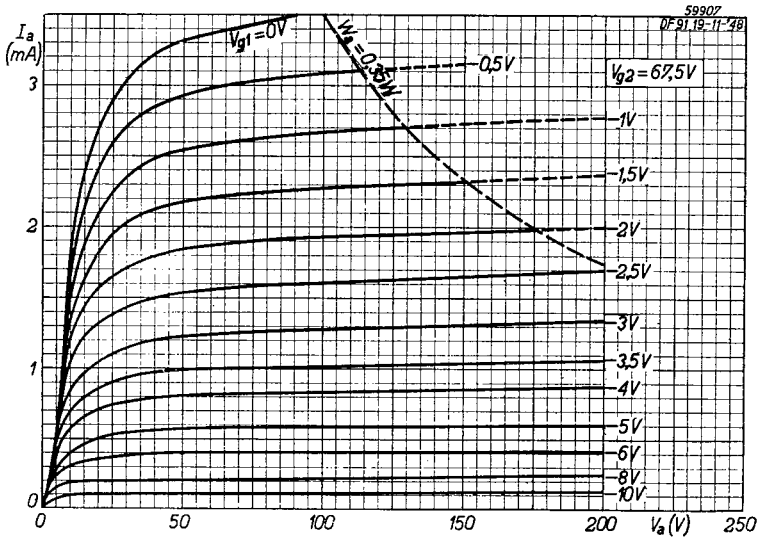

Fig. 6. I_a/V_a characteristics of the DF 91 with $V_{g2} = 67.5$ V.

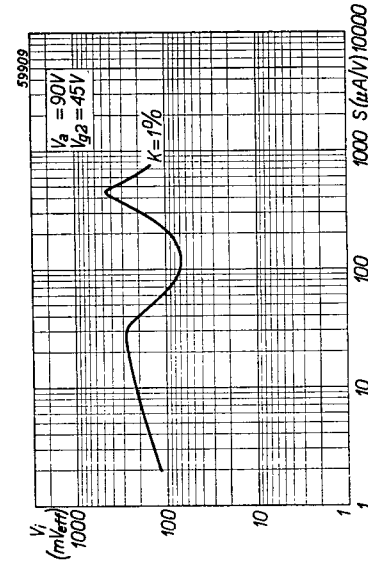
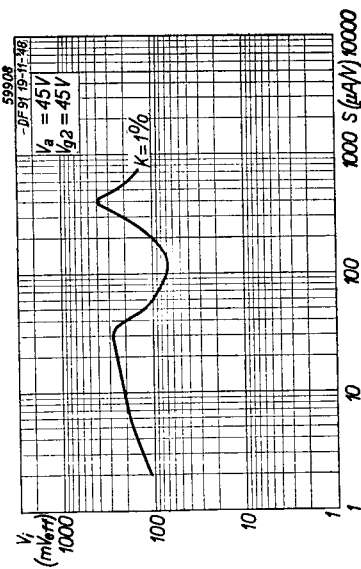
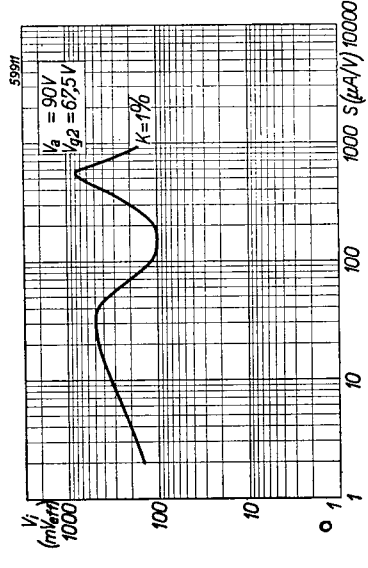
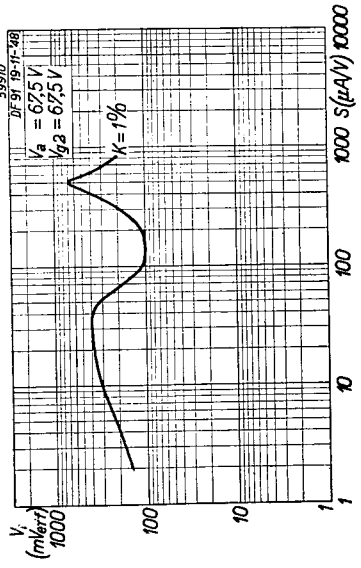

Fig. 8

As Fig 7. Upper : with $V_a = V_{g2} = 67.5\text{ V}$
Lower : with $V_a = 90\text{ V}$ and $V_{g2} = 67.5\text{ V}$.

Fig. 7

The input voltage (V_i) of an interfering signal producing 1% cross-modulation, as a function of the slope (S).
Upper : with $V_a = V_{g2} = 45\text{ V}$. Lower : with $V_a = 90\text{ V}$ and $V_{g2} = 45\text{ V}$.

DK 91 Battery-operated frequency changer

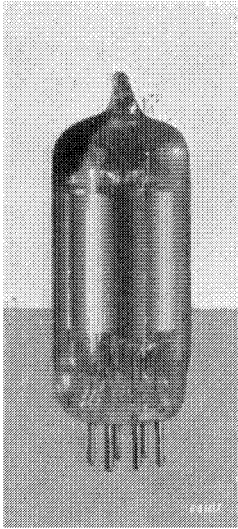

Fig. 1
The DK 91 (approx.
actual size).

The heptode DK 91 is a frequency changer for battery receivers designed to operate on low voltages; having regard also to its small size, it is therefore highly suitable for use in portable sets. The filament current of the DK 91 is 50 mA at 1.4 V, but when fed in series with other valves from an accumulator or mains, it is advisable to limit the voltage to 1.3 V, to ensure that no overloading will occur in the event of fluctuation in the supply voltage.

Good performance is secured at anode and screen grid voltages as low as 45 V, the conversion conductance being then $235 \mu\text{A}/\text{V}$. At 67.5 V the results are naturally much better ($S_c = 280 \mu\text{A}/\text{V}$), but if a 90 V H.T. battery is to be used, the screen grid voltage must be reduced to 67.5 V.

As there is no special electrode in this valve to serve as oscillator anode, the functions of the electrodes differ slightly from the conventional arrangement, the sequence here being: filament, oscillator grid, screen grid, control grid, screen grid, suppressor grid and anode. The circuits in which this valve can be used are therefore also rather unconventional; a few such circuits are described in the following pages,

distinction being made between those in which the DK 91 itself serves as oscillator, and those in which a separate oscillator is employed. The latter naturally consume more current, but this is offset by the greater simplicity of the circuit and the improved performance of the valve in all wave-bands, particularly on short waves.

Self-oscillating circuit with reaction coil (Fig. 2)

In the arrangement shown in Fig. 2 the oscillator circuit is connected to the first grid, a reaction coil being included in the circuit of the positive electrodes. Almost all the current emitted by the filament is used for oscillatory purposes, thus combining sufficient oscillation with good conversion conductance.

It is essential, however, that the reaction coil be wound with the correct number of turns to ensure satisfactory oscillation in both the medium and the long wave-bands, for, should this prove to be insufficient, valve noise will become very much more pronounced. It is therefore important that the direct current flowing to the oscillator grid should be maintained above a certain minimum, this being $30 \mu\text{A}$ for a screen grid voltage of 45 V (with a grid leak of $0.1 \text{ M}\Omega$), or $50 \mu\text{A}$ for 67.5 V.

Furthermore, when deciding upon the strength of the oscillation, it is necessary to take into account the fact that the voltage will drop when the

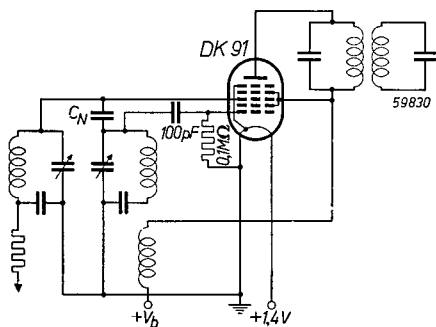

Fig. 2

Mixing circuit using the DK 91, with a reaction coil in the circuit of the positive electrodes.

the positive half-cycle of the oscillator voltage on grid 1, but at this particular moment the oscillator voltage on the screen grids is negative. The effective direct voltage on the screen grids therefore drops when the oscillation amplitude increases, to the detriment of the conversion conductance.

In general, optimum sensitivity is secured in the medium and long wave-bands when the reaction coil contains just so many turns that the direct current flowing to the first grid varies between approximately 50 and 150 μA . To obtain good results in the short-wave band with the circuit shown in Fig. 2, a compensating capacitor C_N must be connected between grid 1 and input (third) grid. Provided that this capacitance is of the correct value, C_N has the effect of reducing the induced voltage on grid 3, and therefore also the adverse effects of this voltage.

This compensating capacitance can be obtained very simply by twisting together two lengths of insulated wire, the correct adjustment being obtained in the following manner: The wave-band switch of the receiver is set to the short-wave band and the set is tuned to the low frequency end of the band. The reaction coil should now contain just so many turns that the current flowing to grid 1 is roughly 20 μA (with a grid leak of 0.1 $\text{M}\Omega$). The receiver is then tuned to the high frequency end of the wave-band and C_N is trimmed for optimum sensitivity. It will be noted that if C_N is too high, the circuit becomes unstable, this being due to excessive coupling between the oscillator and input circuits. A value of C_N slightly below the optimum is therefore recommended, as this greatly reduces the risk of instability without affecting the sensitivity too much.

The effect of C_N on the sensitivity and stability of the receiver is dependent on the oscillator voltage: when this rises, the size of C_N becomes more critical, usually being most decisive at the highest frequencies. Now, the adjustment of C_N can be made less critical by reducing the oscillator voltage, e.g. by connecting a resistor in series with the trimmer in the oscillator circuit. When the wave-band switch of the receiver is set to the medium or long wave-bands, the capacitor C_N may remain between grids 1 and 3 without this having any adverse effects on the characteristics.

H.T. battery is approaching the end of its effective life, and sufficient reaction must therefore be provided to maintain oscillation at reduced anode and screen grid voltages. On the other hand, too many turns on the reaction coil will cause a reduction in conversion conductance and may give rise to squegging. The reason for this drop in conversion conductance is as follows.

An increased number of turns results in an increase in the oscillator voltage on the screen grids. Now, cathode current flows only during

Self-oscillating circuit with reaction coil for operating on 90 V battery

(Figs. 3, 4 and 5)

If the DK 91 is to be used for a receiver operating on a 90 V battery, the circuit described above will be unsuitable, since the maximum permissible screen grid voltage is only 67.5 V. Some modification is therefore necessary.

Fig. 3 shows an alternative arrangement in which the screen grid circuit includes a resistor, the value of which will ensure that the screen grid voltage does not exceed 67.5 V. The conversion conductance in this case is slightly higher than that in the circuit depicted in Fig. 2.

If the receiver also employs the DF 91, another shunted resistor is required to reduce the screen grid voltage of this valve to 67.5 V. Alternatively, a common resistor and capacitor may be used for both the DK 91 and the DF 91, in the manner shown in Figs. 4 and 5. Since the anode voltage of the DK 91 is 90 V in Fig. 4 and only 67.5 V in Fig. 5, the former yields the greater conversion conductance. On the other hand, when the A.G.C. comes into operation in this circuit (Fig. 4), the current flowing through the reaction coil no longer remains constant, the oscillator slope varies, and frequency drift sets in. Such frequency drift is negligible in the medium and long wave-bands, but not on short waves, for which reason it is advisable not to employ A.G.C. in the short wave-band. By way of contrast, in the case of Fig. 5 the current flowing through the reaction coil remains practically constant when control is applied, permitting the use of A.G.C. in the short-wave band as well. Compared with the circuits in Figs. 4 and 5, the arrangement shown in Fig. 3 can be said to combine all the advantages of the other two, although necessitating more components.

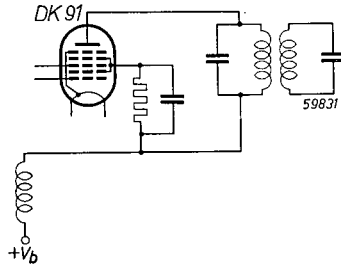

Fig. 3

As Fig. 2, but with a bypassed resistor included in the screen grid feed, to reduce the voltage on these grids.

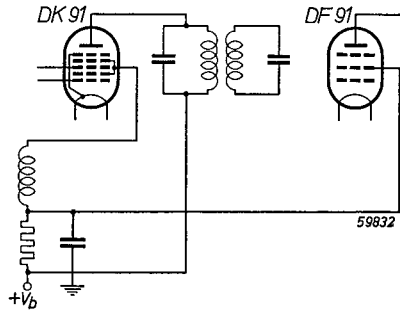

Fig. 4

As Fig. 2, but with the screen grids of the DK 91, together with that of the I.F. amplifier DF 91, fed through a common resistor.

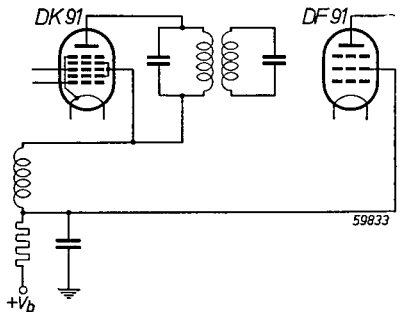

Fig. 5

As Fig. 4, but with the anode of the DK 91 also fed through the common resistor.

DK 91

Self-oscillating circuit with tapped oscillator coil (Fig. 6)

Fig. 6 shows a circuit in which the filament of the DK 91 is connected to a tapping on the oscillator coil; in this case, a capacitor for compensating the induced voltage is not usually required. With this circuit, however, it is rather more difficult to make the valve oscillate properly, and, moreover, an extra choke is needed in the filament circuit.

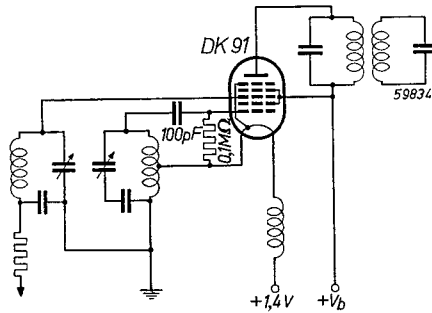

Fig. 6
Mixer circuit employing the DK 91 with the filament connected to a tapping on the oscillator coil.

circu- tance of the choke should be so low that the natural frequency always lies above the highest oscillator frequency.

The tapping on the oscillator coil should be far enough from the earthed end to ensure satisfactory oscillation, but if placed too high it will cause a drop in the conversion conductance. The reason for this is as follows: During the positive half-cycle of the oscillator voltage on grid 1, that is, during the time the filament emits electrons, the oscillator voltage on the filament is also in its positive half-cycle, resulting in an increase in the effective bias on the input (third) grid and a drop in the conversion conductance. The most satisfactory position must therefore be found for the coil tapping; generally speaking, in the medium-wave band the best results are obtained when the current flowing to grid 1 varies between approx. 50 and 150 μ A.

In view of the relatively low impedance of the oscillator circuit in the short-wave band, the coils have to be tightly coupled to secure sufficient oscillator voltage at the low-frequency end of the band. The risk of squegging on short waves, brought about by this tight coupling, is eliminated by including a stopper resistor in the oscillator grid lead. This, however, does not dispose of other undesirable effects of tight coupling, such as excessive frequency drift when control is applied to the valve, and an extra circuit, as described in the section on the ECH 41, is therefore recommended.

To avoid loss of filament voltage, the D.C. resistance of this choke should not be too high, usually not more than 1 ohm. Further, the self-inductance should be such as will provide sufficient impedance at the lowest oscillator frequencies. A choke of this kind, suitable for the long-wave band, will be very large and expensive, for which reason the circuit cannot be recommended for sets which are to include a long-wave band; for receivers without long-wave facilities a self-inductance of 30 - 40 μ H is ample. The self-capacitance of the choke should be so low that the natural frequency always

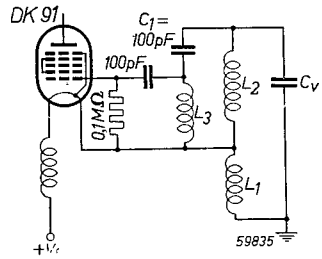

Fig. 7
Short wave oscillator circuit for the DK 91 employing an extra coil L_3 to improve oscillator performance.

This extra circuit causes the oscillator voltage to rise at the low frequency end of the wavelength range, permitting the use of looser coupling. The manner in which this extra circuit is arranged is illustrated in Fig. 7, where the coils L_1 and L_2 with tuning capacitor C_v constitute the oscillator circuit, and coil L_3 with capacitor C_1 the extra circuit. The tuning frequency of the latter should correspond to roughly 3/4 of the lowest frequency in the waveband.

TECHNICAL DATA OF THE HEPTODE FREQUENCY CHANGER DK 91

Filament data

Heating: direct, from battery, rectified A.C., or direct current; series or parallel feed

In parallel with other valves

Filament voltage	V_f	=	1.4 V
Filament current	I_f	=	50 mA

In series with other valves

Filament voltage	V_f	=	1.3 V
----------------------------	-------	---	-------

Capacitances (cold valve)

Input capacitance	C_{g3}	=	7.0 pF
Output capacitance	C_a	=	7.0 pF
Anode - control grid	C_{ag3}	<	0.4 pF
Input capacitance oscillator section	C_{g1}	=	3.8 pF
Anode - oscillator grid	C_{ag1}	<	0.1 pF
Control grid - oscillator grid	C_{g1g3}	<	0.2 pF

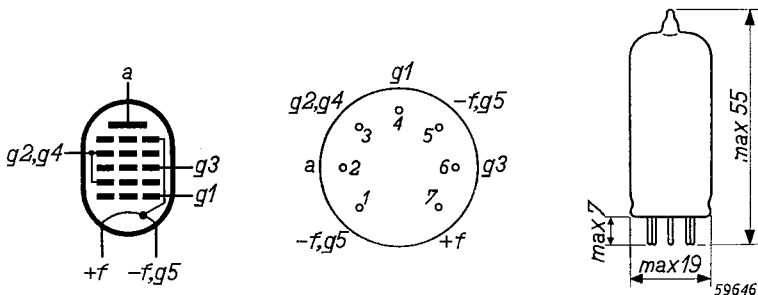

Fig. 8
Electrode arrangement, electrode connections and max. dimensions in mm of the DK 91.

DK 91

Operating characteristics of the DK 91 used as frequency changer

(for circuit see Fig. 2)

Anode and battery voltage	$V_a = V_b$	=	45	90	V
Screen grid voltage	$V_{g^2+g^4}$	=	45	45	V
Oscillator grid leak	R_{g^1}	=	0.1	0.1	MΩ
Oscillator grid current	I_{g^1}	=	150	150	μA
Grid bias	V_{g^3}	=	$\overbrace{0 \text{ —} 9}$	$\overbrace{0 \text{ —} 9}$	V
Anode current	I_a	=	0.7 —	0.8 —	mA
Screen grid current	$I_{g^2+g^4}$	=	1.9 —	1.9 —	mA
Conversion conductance	S_c	=	235 5	250 5	μA/V
Internal resistance	R_i	=	0.6 >10	0.8 >10	MΩ
Anode and battery voltage	$V_a = V_b$	=	67.5	90	V
Screen grid voltage	$V_{g^2+g^4}$	=	67.5	67.5	V
Oscillator grid leak	R_{g^1}	=	0.1	0.1	MΩ
Oscillator grid current	I_{g^1}	=	250	250	μA
Grid bias	V_{g^3}	=	$\overbrace{0 \text{ —} 14}$	$\overbrace{0 \text{ —} 14}$	V
Anode current	I_a	=	1.4 —	1.6 —	mA
Screen grid current	$I_{g^2+g^4}$	=	3.2 —	3.2 —	mA
Conversion conductance	S_c	=	280 5	300 5	μA/V
Internal resistance	R_i	=	0.5 >10	0.6 >10	MΩ
Equivalent noise resistance	R_{eq}	=	185 —	195 —	kΩ

Limiting values

Anode voltage	V_a	= max.	90	V
Anode dissipation	W_a	= max.	0.15	W
Screen grid voltage	$V_{g^2+g^4}$	= max.	67.5	V
Screen grid dissipation	$W_{g^2+g^4}$	= max.	0.25	W
Cathode current	I_k	= max.	5.5	mA
Grid current starting point	$V_{g^3}(I_{g^3} = +0.3\mu\text{A})$	= max.	+0.2	V
External resistance between control grid and cathode	R_{g^3}	= max.	3	MΩ

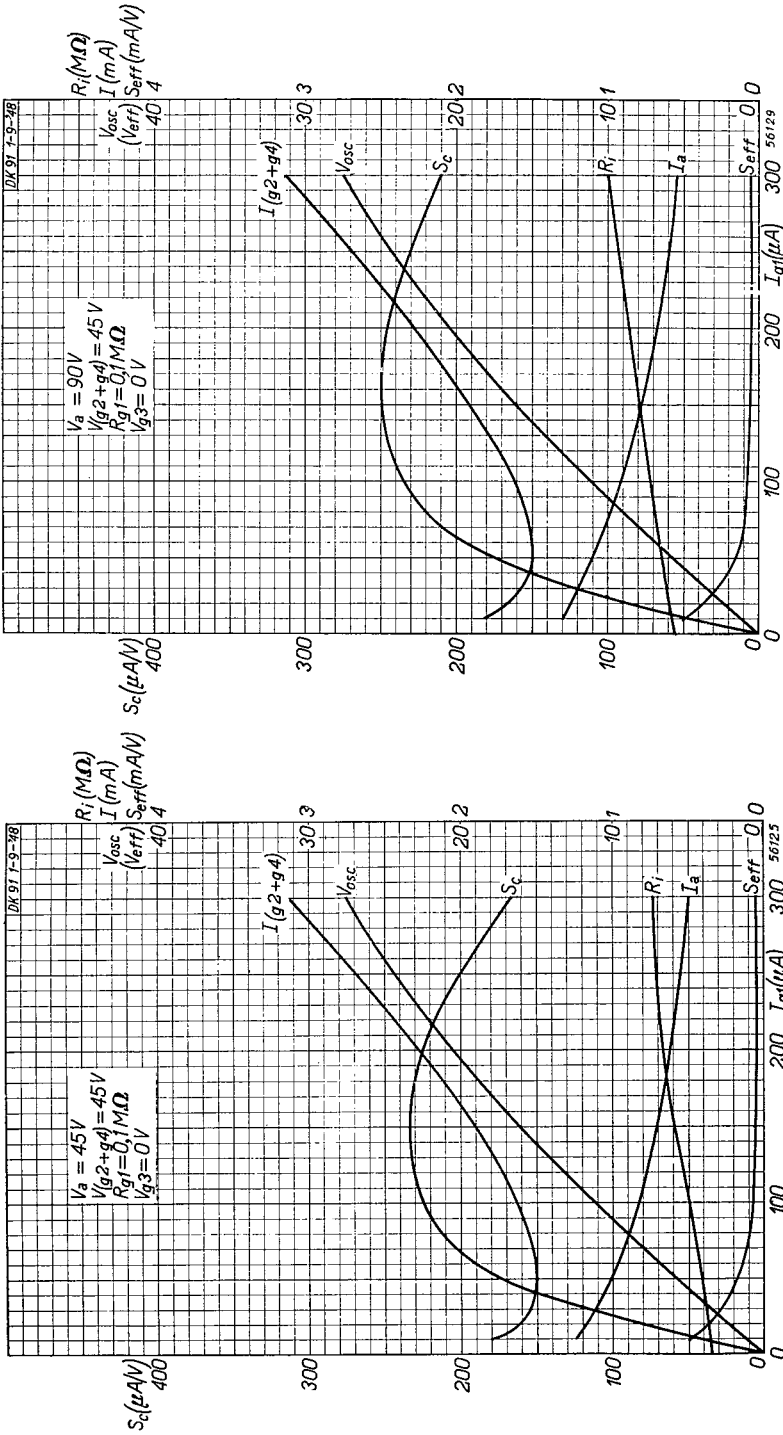

Fig. 9

Fig. 10

Anode current (I_a), screen grid current (I_{g2+g4}), conversion slope (S_c), internal resistance (R_i), oscillator voltage (V_{osc}) and effective slope of the oscillator section (S_{eff}) as functions of the oscillator current (I_{g1}). Fig. 9: anode voltage (V_a) and screen grid voltage (V_{g2+g4}) = 45 V, Fig. 10: anode voltage (V_a) = 90 V and screen grid voltage (V_{g2+g4}) = 45 V. Measured on oscillating valve in the circuit depicted in Fig. 2.

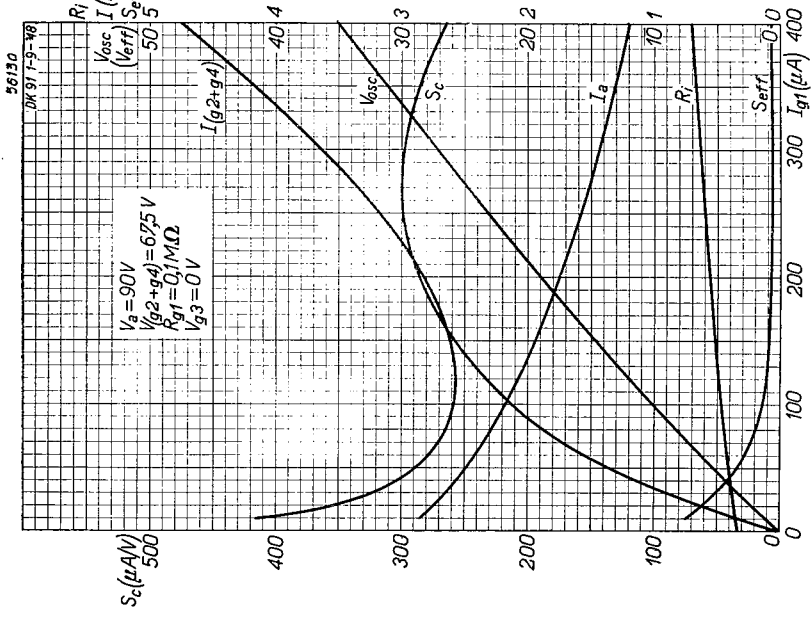

Fig. 12
As Figs. 9 and 10, at $V_a = 90V$ and $V_{g2+g4} = 67.5V$.

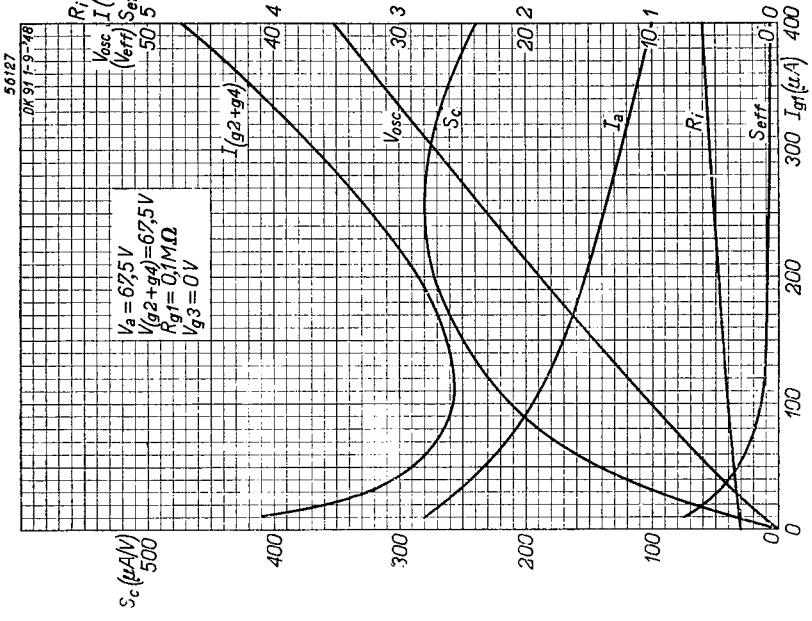

Fig. 11
As Figs. 9 and 10, but at $V_a = V_{g2+g4} = 67.5V$.

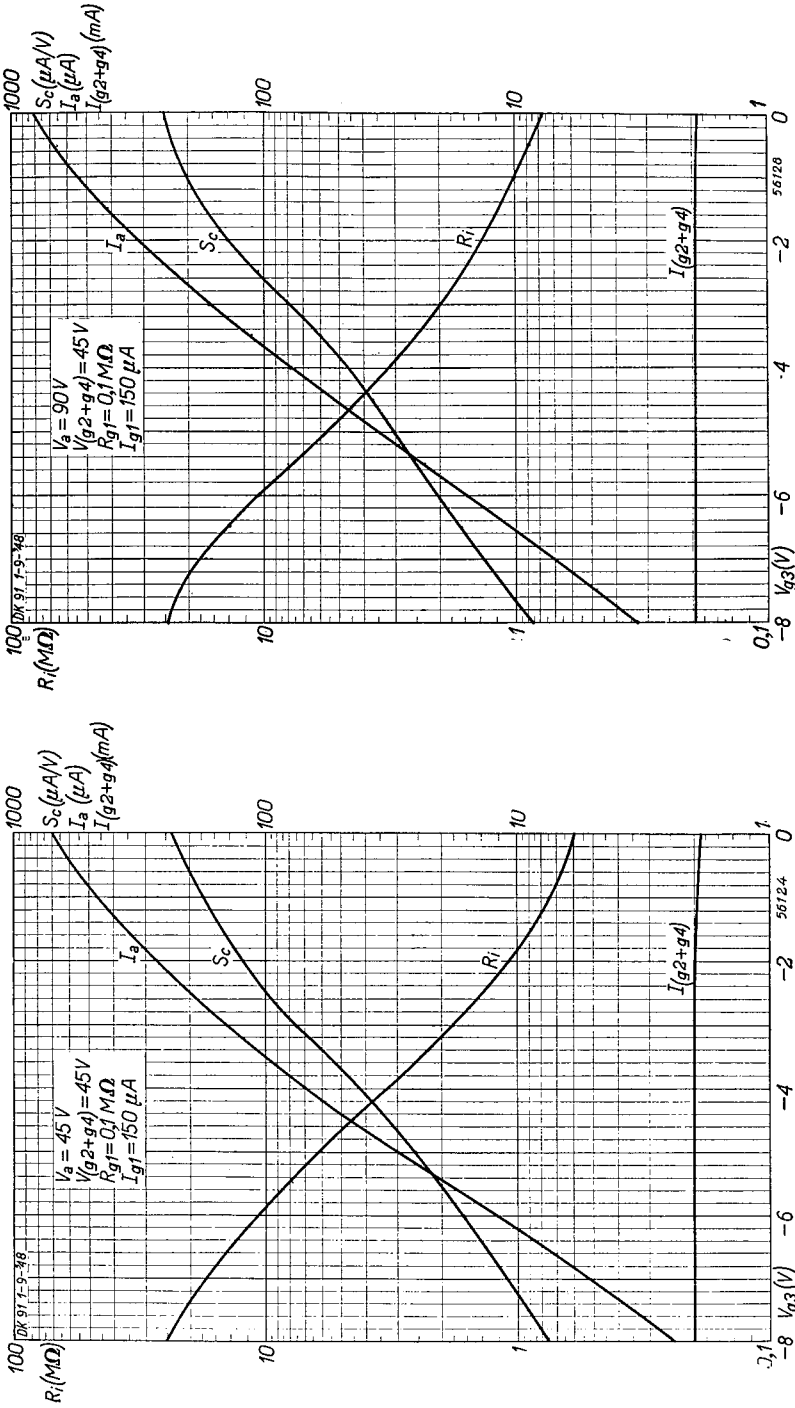

Fig. 13

Anode current (I_a), screen grid current ($I_{g_2+g_4}$), conversion conductance (S_c) and internal resistance (R_i) as functions of the grid bias (V_{g_3}). Measured on oscillating valve in circuit shown in Fig. 2.

Fig. 14

Fig. 13: $V_a = V_{g_2+g_4} = 45$ V; Fig. 14: $V_a = 90$ V, $V_{g_2+g_4} = 45$ V.

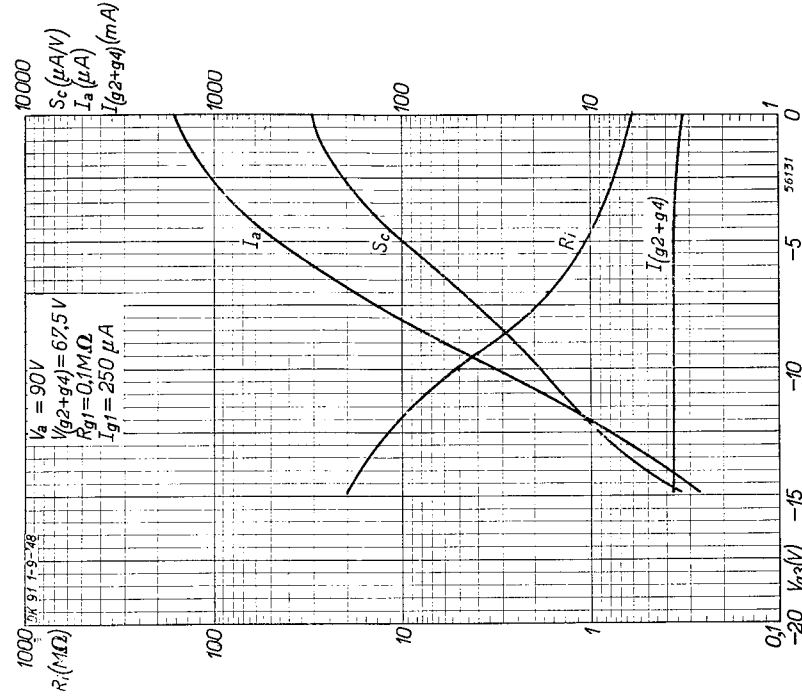

Fig. 15, As Figs. 13 and 14, at $V_a = V_{g_2+g_4} = 67.5 \text{ V}$.

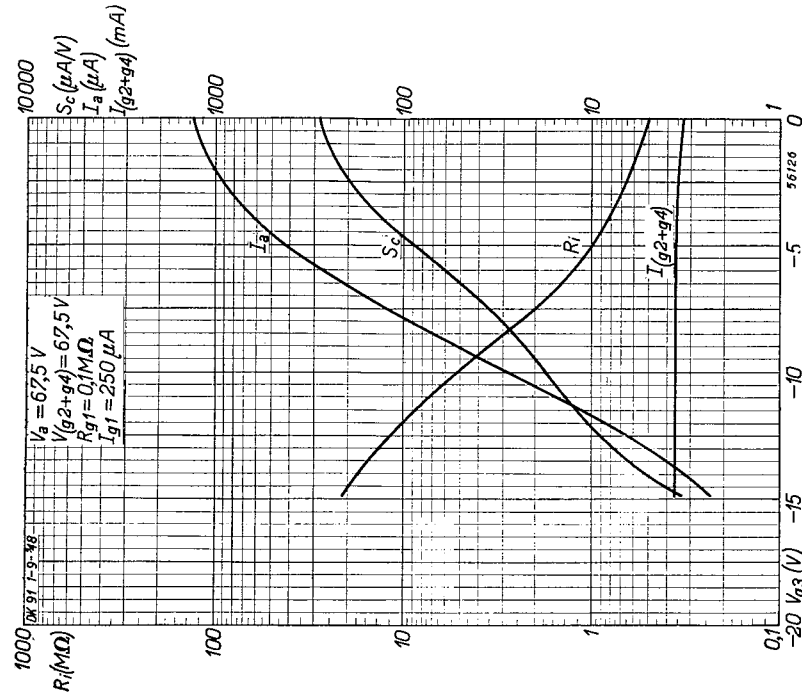

Fig. 16, As Figs. 13 and 14, but at $V_a = 90 \text{ V}$, $V_{g_2+g_4} = 67.5 \text{ V}$.

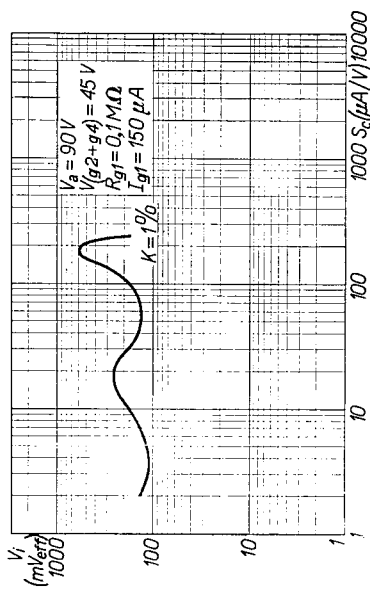
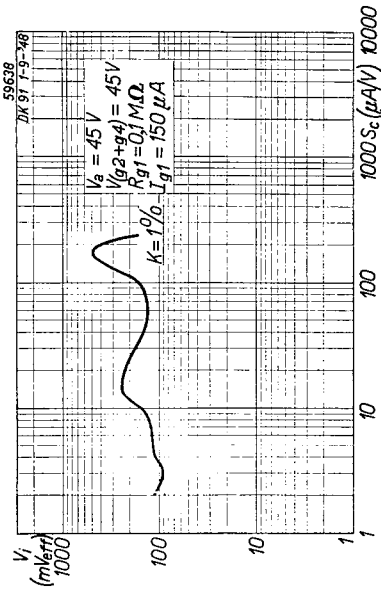

Fig. 17

The voltage (V_i) of an interfering signal at the control grid producing 1% cross-modulation is shown as a function of the conversion conductance.

Fig. 17, upper: $V_a = V_{g2+g4} = 45 \text{ V}$; lower: $V_a = 90 \text{ V}$, $V_{g2+g4} = 45 \text{ V}$.
 Fig. 18, upper: $V_a = V_{g2+g4} = 67.5 \text{ V}$; lower: $V_a = 90 \text{ V}$, $V_{g2+g4} = 67.5 \text{ V}$.

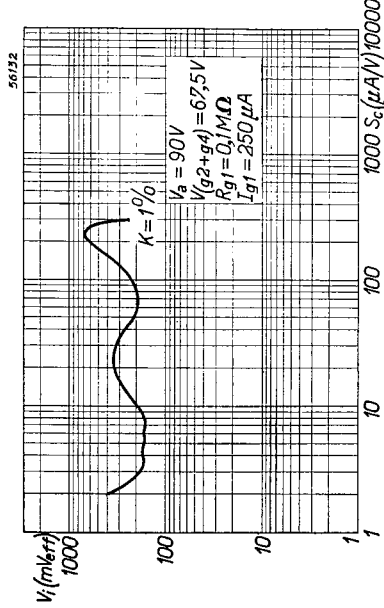
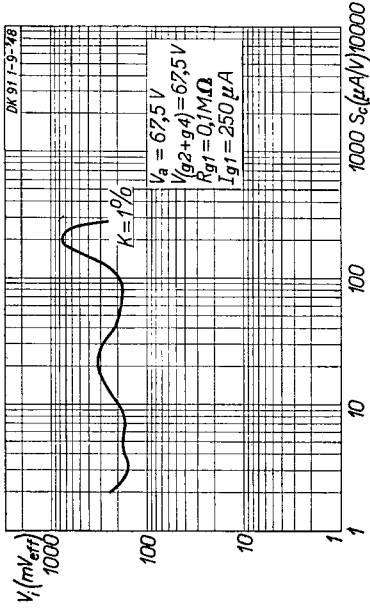

Fig. 18

DL 92 Battery output pentode

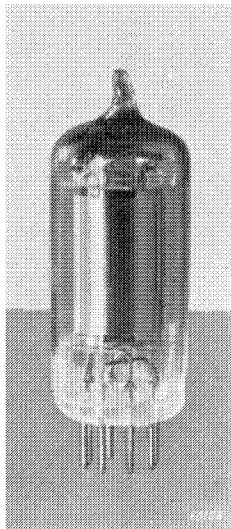

Fig. 1. The DL 92, approximately full-size.

The DL 92 is an output pentode which was specially developed for small (portable) battery sets. Accordingly, the maximum permissible voltages are low (67.5 V screen grid, 90 V anode). With 67.5 V on both anode and screen grid the output power is 180 mW; if the anode voltage is increased to 90 V the output power is 270 mW: for this output the total cathode-current consumption is nearly 9 mA.

The filament of the DL 92 is made in two identical sections, which can be connected either in series or in parallel. In the former arrangement the nominal filament voltage is 2.8 V and the nominal filament current 50 mA, in the latter arrangement 1.4 V and 100 mA. When the filament sections are connected in series, the filament as a whole can be connected in series with other valves in the circuit, which is important whether power is derived from an accumulator or from the mains.

In order to ensure that filaments connected in series will not be overloaded in the event of voltage fluctuations, it is advisable to adjust the voltage across each filament section to 1.3 V. Furthermore, a 250 to 300 ohm resistor must be connected across the negative half, to prevent the current emitted by the positive half from flowing through it. If necessary, another resistor may be connected across the whole of the filament, to provide a shunt for the cathode current from other valves.

TECHNICAL DATA OF THE BATTERY OUTPUT PENTODE DL 92

Filament data

Heating : direct, from battery, rectified A.C., or D.C.; series or parallel feed

A. Both sections of filament connected in parallel

a. In parallel with other valves

Filament voltage	V_f	=	1.4 V
Filament current	I_f	=	100 mA

b. In series with other valves

Filament voltage	V_f	=	1.3 V
----------------------------	-------	---	-------

B. Both sections of filament connected in series

a. In parallel with other valves

Filament voltage	V_f	=	2.8 V
Filament current	I_f	=	50 mA

b. In series with other valves

Filament voltage	V_f	=	2.6 V
----------------------------	-------	---	-------

Capacitances (cold valve)

Input capacitance	C_{g1}	=	4.35 pF
Output capacitance	C_a	=	6.0 pF
Anode - control grid	C_{ag1}	<	0.4 pF

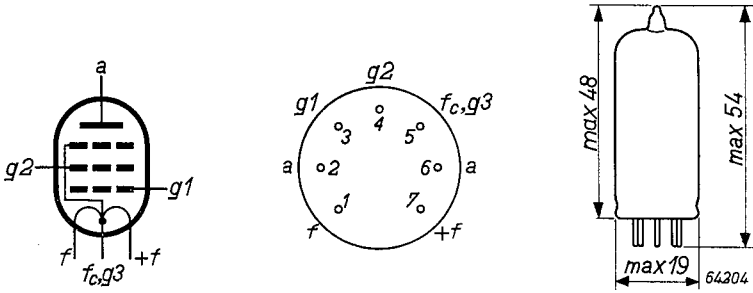

Fig. 2

Electrode arrangement, electrode connections and max. dimensions in mm.

Operating characteristics of a single valve in Class A

(base connections 5 (—) and 1 + 7 (+), $V_f=1.4$ V, $I_f=100$ mA)

Anode voltage	V_a	=	45 67.5 90 V
Screen grid voltage	V_{g2}	=	45 67.5 67.5 V
Grid bias	V_{g1}	=	-4.5 -7 -7 V
Anode current	I_a	=	3.8 7.2 7.4 mA
Screen grid current	I_{g2}	=	0.8 1.5 1.4 mA
Mutual conductance	S	=	1250 1550 1570 μ A/V
Internal resistance	R_i	=	0.1 0.1 0.1 M Ω
Amplification factor of grid 2			
with respect to grid 1	μ_{g2g1}	=	5 5 5
Optimum load resistance	R_a	=	8 5 8 k Ω
Output power	W_0	=	65 180 270 mW
Alternating input voltage	$V_i(W_0=\text{max})$	=	3.5 5.5 5.5 V_{RMS}
Distortion	$d_{tot}(W_0=\text{max})$	=	12 10 12 %
Sensitivity	$V_i(W_0=50\text{mW})$	=	2.8 2.5 1.95 V_{RMS}

Operating characteristics of a single valve in Class A

(base connections 1 (—) and 7 (+), $V_f=2.8$ V, $I_f=50$ mA)

Anode voltage	V_a	=	45	67.5	90	V
Screen grid voltage	V_{g2}	=	45	67.5	67.5	V
Grid bias	V_{g1}	=	-4.5	-7	-7	V
Anode current	I_a	=	3.0	6.0	6.1	mA
Screen grid current	I_{g2}	=	0.7	1.2	1.1	mA
Mutual conductance	S	=	1100	1400	1420	$\mu\text{A/V}$
Internal resistance	R_i	=	0.1	0.1	0.1	M Ω
Amplification factor of grid 2						
with respect to grid 1	μ_{g2g1}	=	5	5	5	
Optimum load resistance	R_a	=	8	5	8	k Ω
Output power	W_0	=	50	160	235	mW
Alternating input voltage	$V_i(W_0=\text{max})$	=	3.5	5.5	5.5	V_{RMS}
Distortion	$d_{tot}(W_0=\text{max})$	=	12.5	12	13	%
Sensitivity	$V_i(W_0=50\text{mW})$	=	3.5	2.5	1.95	V_{RMS}

Operating characteristics of two valves in Class B push-pull

(base connections 5 (—) and 1 + 7 (+), $V_f = 1.4$ V, $I_f=100$ mA per valve)

Battery voltage	V_b	=	90	V
Anode voltage	V_a	=	80	V
Screen grid voltage	V_{g2}	=	57.5	V
Grid bias	V_{g1}	=	-9.9	V
Optimum load resistance between the two anodes	R_{aa}	=	16	k Ω
Alternating input voltage	V_i	=	0	7.3 V_{RMS}
Anode current	I_a	=	2 \times 1.5	2 \times 4.4 mA
Screen grid current	I_{g2}	=	2 \times 0.3	2 \times 1.35 mA
Output power	W_0	=	0	325 mW
Distortion	d_{tot}	=	—	5 %

Operating characteristics of two valves in Class B push-pull

(base connections 1 (—) and 7 (+), $V_f = 2.8$ V, $I_f = 50$ mA per valve)

Battery voltage	V_b	=	90	V
Anode voltage	V_a	=	81	V
Screen grid voltage	V_{g2}	=	58.5	V
Grid bias	V_{g1}	=	-9.2	V
Optimum load resistance between the two anodes	R_{aa}	=	18	k Ω
Alternating input voltage	V_i	=	0	7.0 V_{RMS}
Anode current	I_a	=	2 \times 1.5	2 \times 4.2 mA
Screen grid current	I_{g2}	=	2 \times 0.3	2 \times 1.25 mA
Output power	W_0	=	0	315 mW
Distortion	d_{tot}	=	—	4.7 %

Limiting values

Anode voltage	V_a	= max.	90 V
Anode dissipation	W_a	= max.	0.7 W
Screen grid voltage	V_{g2}	= max.	67.5 V
Screen grid dissipation without input signal	$W_{g2}(V_i=0)$	— max.	0.12 W
Screen grid dissipation at maximum output power	$W_{g2}(W_0=\text{max})$	= max.	0.2 W
Grid current starting point	$V_{g1}(I_{g1}=+0.3 \mu\text{A})$	= max.	+0.2 V
Cathode current	I_k	= max.	11 mA
External resistance between control grid and cathode	R_{g1}	= max.	2 M Ω

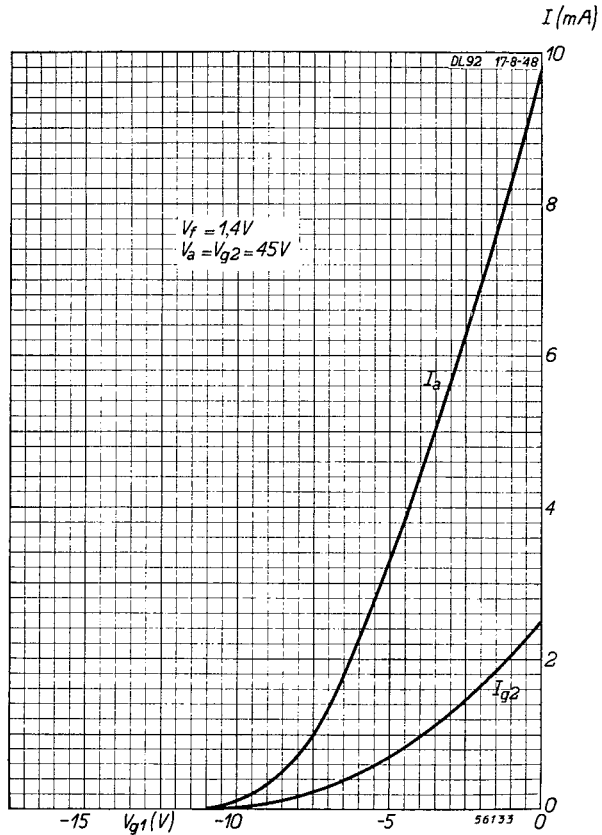

Fig. 3
Anode current (I_a) and screen grid current (I_{g2}) as functions of the grid bias (V_{g1}), at $V_a = V_{g2} = 45$ V.

I_a (mA)

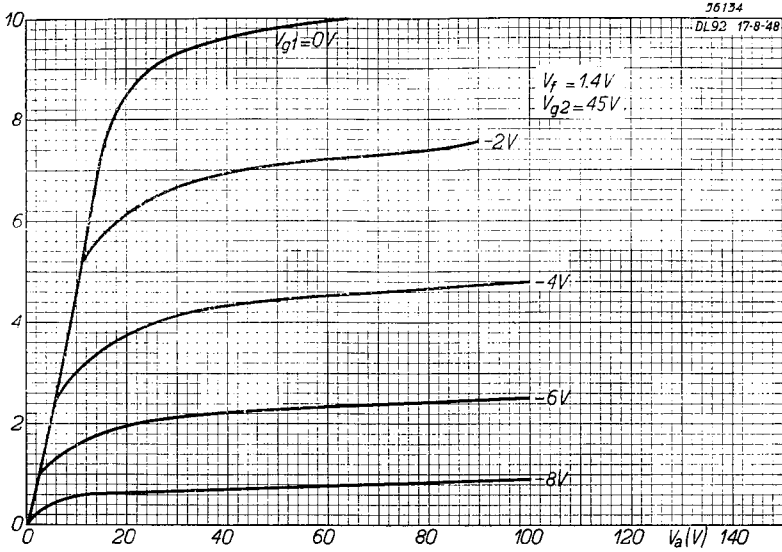

Fig. 4

Anode current (I_a) as a function of the anode voltage (V_a) with grid bias (V_{g1}) as parameter, at a screen grid voltage (V_{g2}) = 45 V. Filament connections 5 (—) and 1 + 7 (+), $V_f = 1.4$ V, $I_f = 100$ mA.

V_i (V_{eff})
 I (mA)

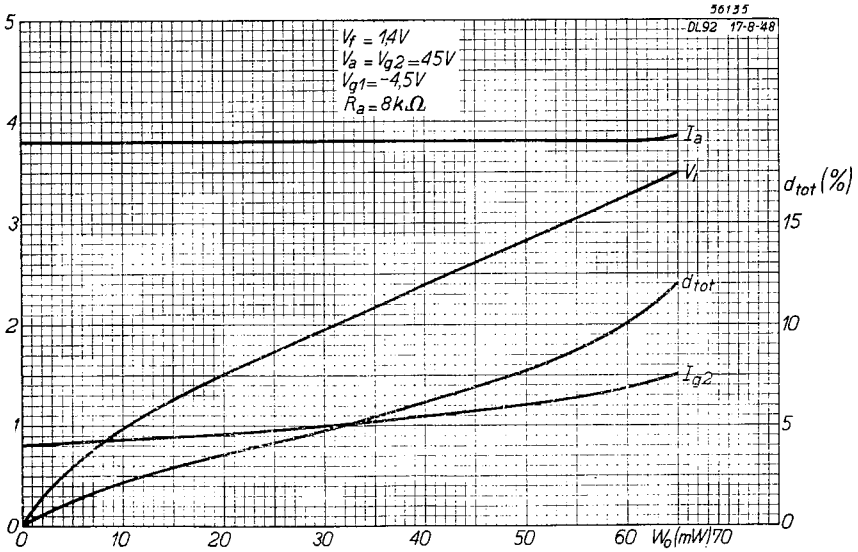

Fig. 5

Anode current (I_a), screen grid current (I_{g2}), required alternating input voltage (V_i) and distortion (d_{tot}) as functions of the output power (W_0), at $V_a = V_{g2} = 45$ V. Filament connections as for Fig. 4.

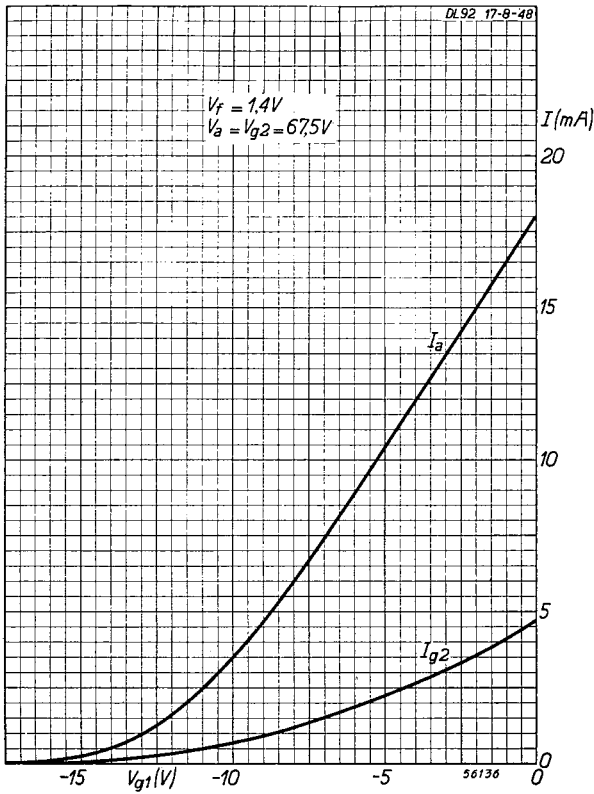
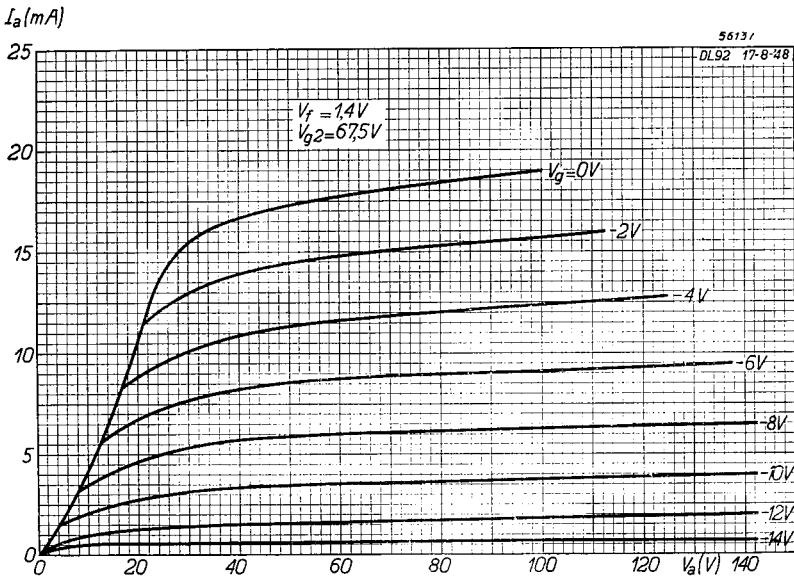

Fig. 6
Anode current (I_a) and screen grid current (I_{g2}) as functions of the grid bias (V_{g1}), at $V_a = V_{g2} = 67.5$ V. Filament connections 5 (—) and 1+7 (+), $V_f = 1.4$ V, $I_f = 100$ mA.

Fig. 7
 I_a/V_a characteristics; voltages and filament connections as for Fig. 6.



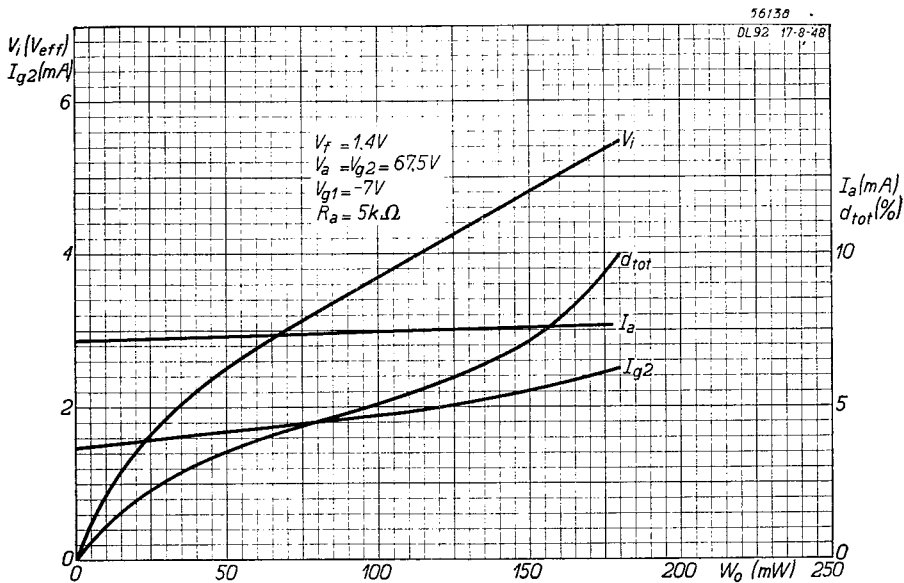

Fig. 8
Anode current (I_a), screen grid current (I_{g2}), required alternating input voltage (V_i) and distortion (d_{tot}) as functions of the output power (W_o), at $V_a = V_{g2} = 67.5$ V. Filament connections as for Fig. 6.

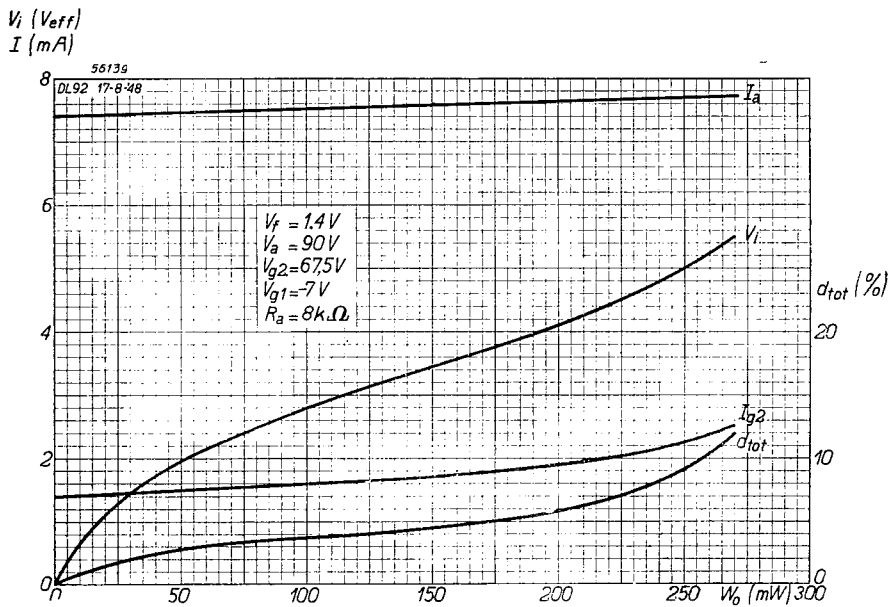

Fig. 9
As Fig. 8, but at $V_a = 90$ V and $V_{g2} = 67.5$ V.

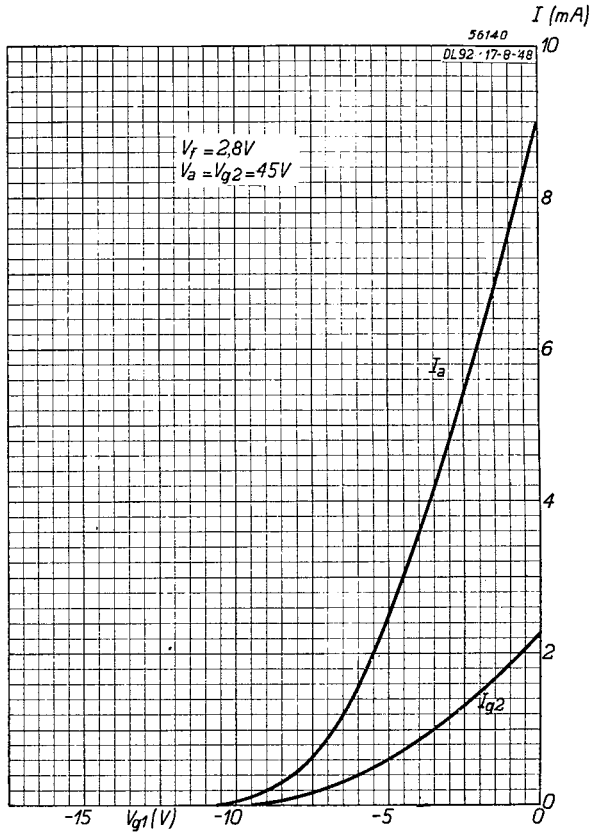

Fig. 10
Anode current (I_a) and screen grid current (I_{g2}) as functions of the grid bias (V_{g1}), at $V_a = V_{g2} = 45$ V. Filament connections 1 (—) and 7 (+), $V_f = 2.8$ V, $I_f = 50$ mA.

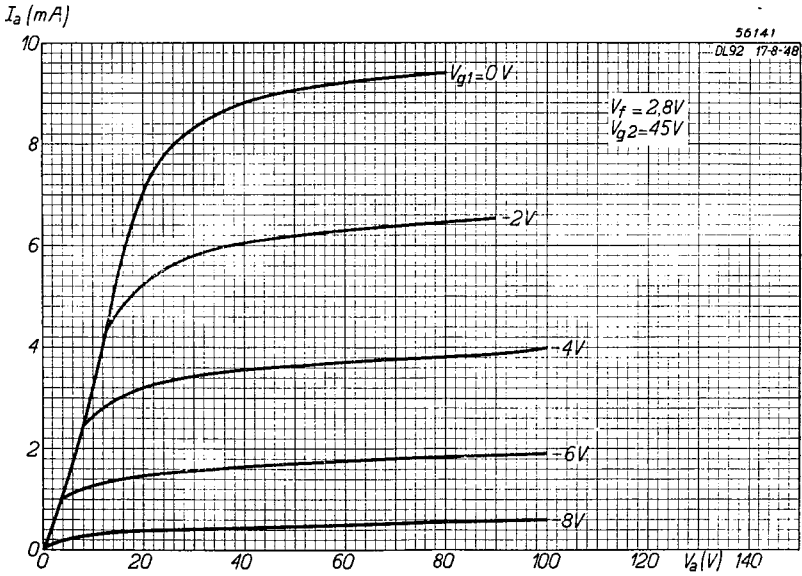

Fig. 11
 I_a/V_a characteristics at $V_{g2} = 45$ V. Filament connections 1 (—) and 7 (+), $V_f = 2.8$ V, $I_f = 50$ mA.

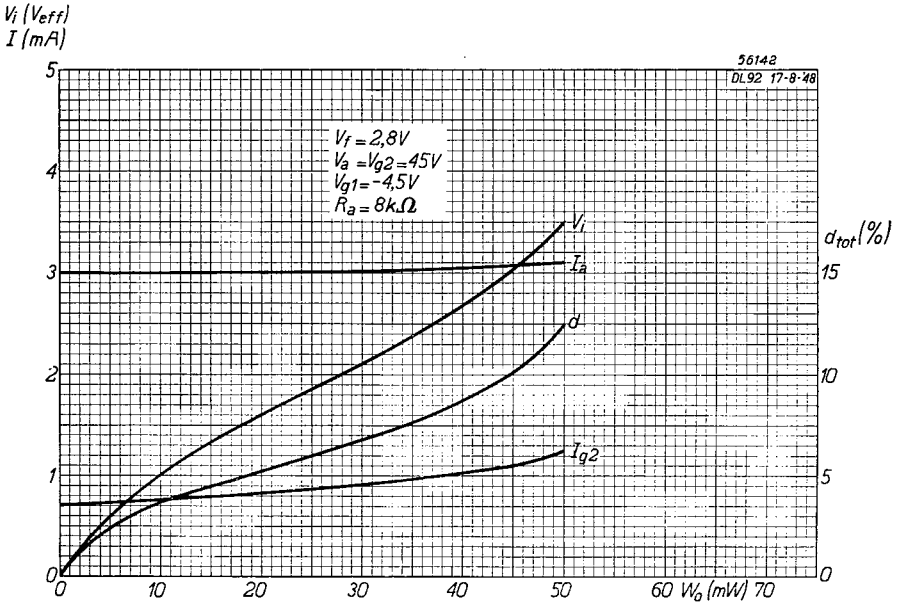

Fig. 12
Anode current (I_a), screen grid current (I_{g2}), required alternating input voltage (V_i) and distortion (d_{tot}) as functions of the output power (W_o), at $V_a = V_{g2} = 45$ V. Filament connections as for Fig. 11.

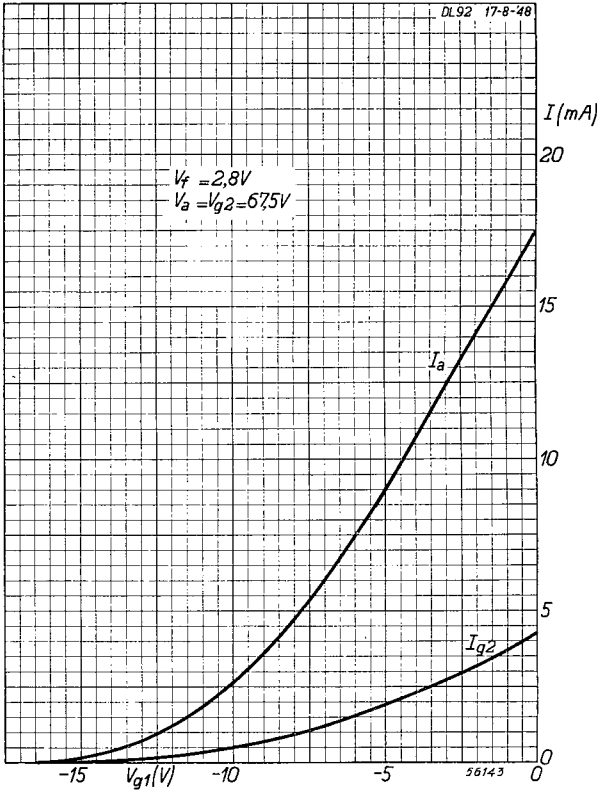

Fig. 13
Anode current (I_a) and screen grid current (I_{g2}) as functions of the grid bias (V_{g1}), at $V_a = V_{g2} = 67.5$ V. Filament connections 1 (—) and 7 (+), $V_f = 2.8$ V, $I_f = 50$ mA.

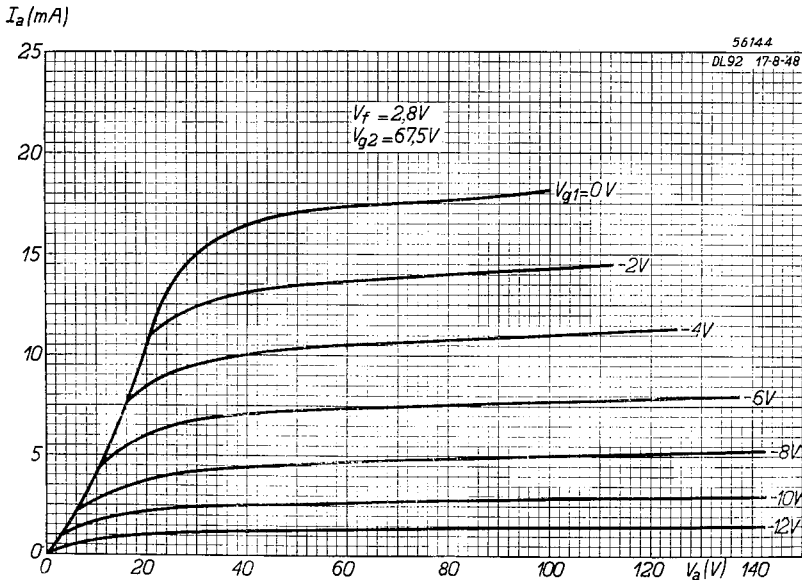

Fig. 14
 I_a/V_a characteristics at $V_{g2} = 67.5$ V. Filament connections as for Fig. 13.

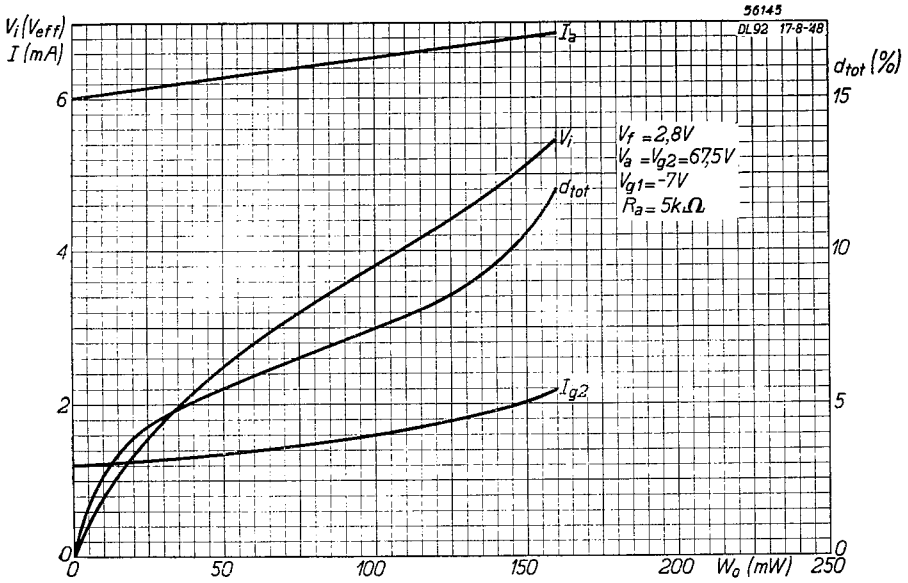

Fig. 15
Anode current (I_a), screen grid current (I_{g2}), required alternating input voltage (V_i) and distortion (d_{tot}) as functions of the output power (W_o), at $V_a = V_{g2} = 67.5$ V. Filament connections 1 (—) and 7 (+), $V_f = 2.8$ V, $I_f = 50$ mA.

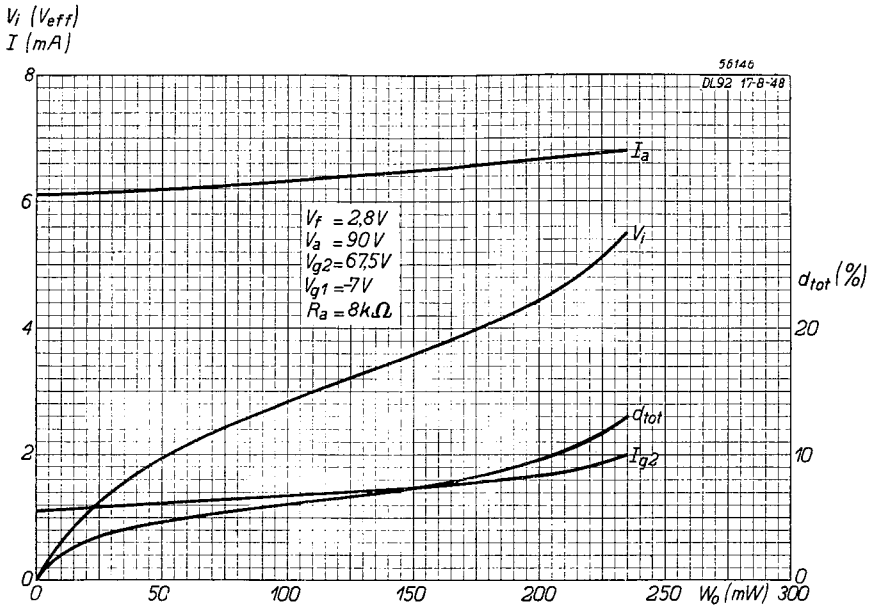

Fig. 16
As Fig. 15, but at $V_a = 90$ V and $V_{g2} = 67.5$ V.

XII. A battery receiver employing "Miniwatt" miniature valves

Introduction

This is a design for a simple, economical battery receiver employing four miniature valves, viz.

- DK 91 — frequency changer,
- DF 91 — I.F. amplifier,
- DAF 91 — detector and A.F. amplifier,
- DL 92 — output valve.

Although the circuit shown in Fig. 1 is intended for a 90 V battery, the values of the components are such that a 67.5 V battery will also give excellent results; the maximum output power of the DL 92 is 215 mW at 90 V battery voltage, or 145 mW at 67.5 V. A loudspeaker with high acoustic efficiency is desirable, particularly when operating at the lower battery voltage. Sensitivity, roughly 60 μ V at a nominal voltage of 90 V, is almost as good at $V_b=67.5$ V, viz. about 80 μ V.

The filament voltage is 1.4 V, the filament sections of the DL 92 being connected in parallel, and the current taken from the H.T. battery is about 18 mA at $V_b=90$ V, or approx. 17.5 mA at $V_b=67.5$ V. The total filament current consumed is 250 mA. It is also possible to use only one of the filament sections of the DL 92, thus reducing the total filament current to 200 mA and the total H.T. drain to about 14 mA, but the maximum output is then only 105 mW at $V_b=90$ V, or 70 mW at $V_b=67.5$ V.

The wave-bands are as follows :

- long waves — approx. 800-2000 m,
- medium waves — approx. 200-600 m,
- short waves — approx. 18-60 m.

DESCRIPTION OF THE CIRCUIT

The mixing stage

The aerial is coupled to the R.F. circuits by means of high-inductance coils, ensuring a constant aerial gain of approximately 4 throughout the entire wavelength range (see Fig. 1).

Every care was taken in designing the oscillator section to ensure a sufficiently high oscillator voltage, to which end the alternating current flowing through the anode circuit of the DK 91 at oscillator frequency is taken through the feedback coils L_8 , L_{10} and L_{12} . In addition, the padding capacitors for medium and long waves are connected in series with the tuning capacitor, this having the effect of producing a more constant oscillator voltage in each wave-band.

Electronic coupling between first and third grids, which might permit part of the oscillator voltage to reach the R.F. circuit, to the detriment of the conversion conductance, can be minimized by connecting a capacitor of about 4 pF between these grids, e.g. in the form of a few centimetres of

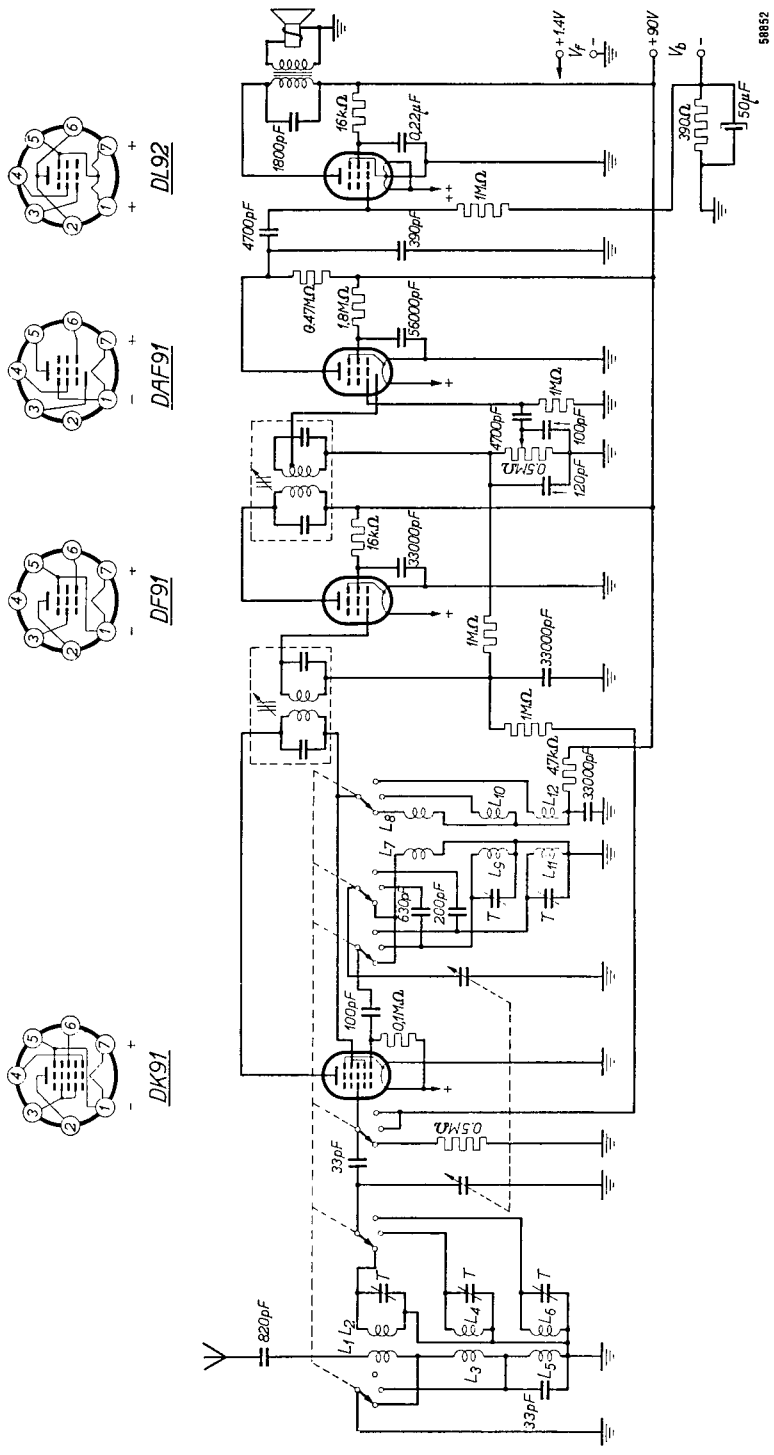

Fig. 1
A 4-valve battery receiver.

58652

twisted, insulated wire. It is fairly easy so to compensate this coupling that the induced voltage in the R.F. circuit will be less than 200 mV over the whole of the medium wave-band.

When using an I.F. transformer with a Q of 140 and tuning capacitors of 100 pF, the conversion gain is approximately 38; therefore, with a gain of 4 in the R.F. circuit, the overall amplification from the aerial to the control grid of the I.F. valve is roughly 150.

The I.F. stage

The I.F. stage is of conventional design. The secondary winding of the second I.F. transformer is tapped at 7/10ths of its total turns for the diode feed; this is to reduce the damping effect of the diode on the I.F. transformer. In view of the fact that the damping of the diode varies considerably with the signal strength, the gain in this stage is also dependent on the signal strength. With an I.F. voltage of 350 mV_{RMS} on the diode, which, with 30% modulation, corresponds to an output power of 50 mW, the overall amplification from the control grid of the I.F. valve to the diode is 45, provided, that an I.F. transformer with a Q of 140 and tuning capacitors of 100 pF are also used here.

Detection, A.G.C. and A.F. amplification

The direct voltage component of the detected signal is applied to the control grids of the I.F. valve and the frequency changer. In the short-wave band, however, the A.G.C. is not applied to the frequency changer, as this would lead to excessive frequency drift in the oscillator. The detected A.F. signals are taken, through a 4700 pF coupling capacitor, to the control grid of the pentode section of the DAF 91.

The A.F. amplification is roughly 50, which should be regarded as a maximum, since any increase would be liable to cause microphony.

The output stage

At a battery voltage of 90 V, the load resistance required for maximum A.F. output of the DL 92 is 8 k Ω ; on a nominal voltage of 67.5 V, the correct value is 5 k Ω . In view of this difference it is advisable to use an output transformer with tapped secondary, so that the load resistance can be adapted to all working conditions. Grid bias is derived from a 390 ohm resistor connected in the negative line from the H.T. battery.

When the nominal voltages $V_b=90$ V and $V_f=1.4$ V drop to 60 V and 1.1 V respectively, the maximum output power is 110 mW.

MEASURED VALUES

Currents and voltages at $V_b = 90$ V

DL 92 - output valve

Anode voltage	78 V
Screen grid voltage	67.5 V
Grid bias	-7 V
Anode current	7.4 mA
Screen grid current	1.4 mA

DAF 91 - A.F. amplifier and detector

Anode voltage	22 V
Screen grid voltage	18 V
Anode current	0.13 mA
Screen grid current	0.036 mA

DF 91 - I.F. amplifier

Anode voltage	83 V
Screen grid voltage	67.5 V
Anode current	3.5 mA
Screen grid current	1.4 mA

DK 91 - frequency changer

Anode voltage	67.5 V
Screen grid voltage	67.5 V
Anode current	1.4 mA
Screen grid current	3.2 mA

When a 67.5 V battery is used, the resistors in the screen grid circuits of the valves DL 92 and DF 91, as well as the 4700 ohm resistor in the screen grid and anode circuits of the DK 91, may be short circuited. The currents taken by the valves at $V_b = 67.5$ V are the same as for 90 V.

Sensitivity for $V_b = 90$ V, with an output power of 50 mW and 30% modulation, measured at 1000 kc/s

At the control grid of the DL 92	2 V
„ „ „ „ „ „ DAF 91	40 mV
„ „ diode of the DAF 91 (I.F.)	350 mV
„ „ control grid of the DF 91	8 mV
„ „ „ „ „ „ DK 91	230 μ V
„ „ aerial connection	60 μ V

For a nominal voltage $V_b = 67.5$ V, the sensitivity is approximately 80 μ V

Average selectivity

1:10	when the receiver is detuned	± 5 kc/s
1:100	„ „ „ „ „	± 11 kc/s
1:1000	„ „ „ „ „	± 25 kc/s

Coil data

The self-inductances (L), quality factors (Q) and coupling factors ($t=M/L$) of the coils used in this receiver, as well as the wire thicknesses and numbers of turns, are given in the following table :

Coil	Number of turns	Diameter of the wire	Self-inductance	Q	$t=M/L$
L_1	$29^2/8$	0.1 mm	10 μ H	—	0.60
L_2	$19^2/8$	0.4 mm	1.84 μ H	100	
L_3	298	0.07 mm	1 mH	—	0.10
L_4	236	9×0.05 mm	225 μ H	100	
L_5	1052	0.07 mm	10 mH	—	0.17
L_6	568	0.07 mm	2.7 mH	45	
L_7	$19^2/8$	30×0.03 mm	1.42 μ H	120	0.83
L_8	$11^3/8$	0.1 mm	—	—	
L_9	105	0.1 mm	122 μ H	75	0.40
L_{10}	36	0.1 mm	—	—	
L_{11}	245	0.1 mm	646 μ H	35	0.29
L_{12}	45	0.1 mm	—	—	

XIII. A 4-valve battery receiver

Introduction

This design incorporates two Rimlock valves, the DK 40 and DL 41, and two miniature valves, the DF 91 and DAF 91. The frequency changer DK 40 ensures good reception on medium and long wavelengths, and complete freedom from frequency drift when A.G.C. is employed. With a battery voltage of 90 V, the DL 41 delivers an output of 320 mW, this being more than enough to provide reasonable sound output from an efficient loudspeaker. The average overall sensitivity of the receiver is 70 μ V. The filaments take a current of 250 mA at 1.4 V, and the battery drain is 18 mA on a battery voltage $V_b = 90$ V.

The receiver is designed for the following wave-bands:

long waves	approx. 800—2000 m,
medium waves	approx. 200— 600 m,
short waves	approx. 15— 50 m.

Circuit description

Standard high-inductance coils are used to couple the aerial to the R.F. circuit, giving an aerial gain of approximately 2. The R.F. signal is applied to the fourth grid of the DK 40 and the oscillator circuit between grids 1 and 2. In contrast with the receiver described in section X, the tuned oscillator circuit is now connected to the grid and the reaction coil to the anode, i.e. the second grid of the DK 40. Fig. 2 shows the variations in oscillator current, which provides a measure of the oscillator voltage, as a function of the frequency in each of the three wave-bands; it will be seen that the oscillator voltage is not very constant throughout the frequency range and that some improvement may be desirable. An improvement can be made quite simply by connecting the reaction coil to the "top" of the padding capacitor (Fig. 3) instead of earthing it. The overall sensitivity will then be approximately 45 μ V, instead of 70 μ V. On the other hand, if mixed feedback is desired in the long as well as in the medium wave-band, a few extra contacts will be needed on the wave-change switch. For the sake of clearness the extra feedback from across the padding capacitor is not illustrated in the circuit diagram (Fig. 1).

The effect of extra feedback in the medium wave-band is included in Fig. 2 (curve *a*); in the medium and long wave-bands the feedback ratio $M/L = 0.16$, on short waves 0.25.

It is generally known that electronic coupling occurs between the first and fourth grids of every octode, i.e. between oscillator and R.F. sections, resulting in an induced voltage at oscillator frequency in the R.F. circuit, which, in turn, causes radiation and reduces the conversion gain. This induced voltage can be compensated very easily, however, by introducing a small amount of capacitance (approx. 1.5 pF) between the first and fourth grids; this does not necessitate an extra capacitor, as this compensation can be

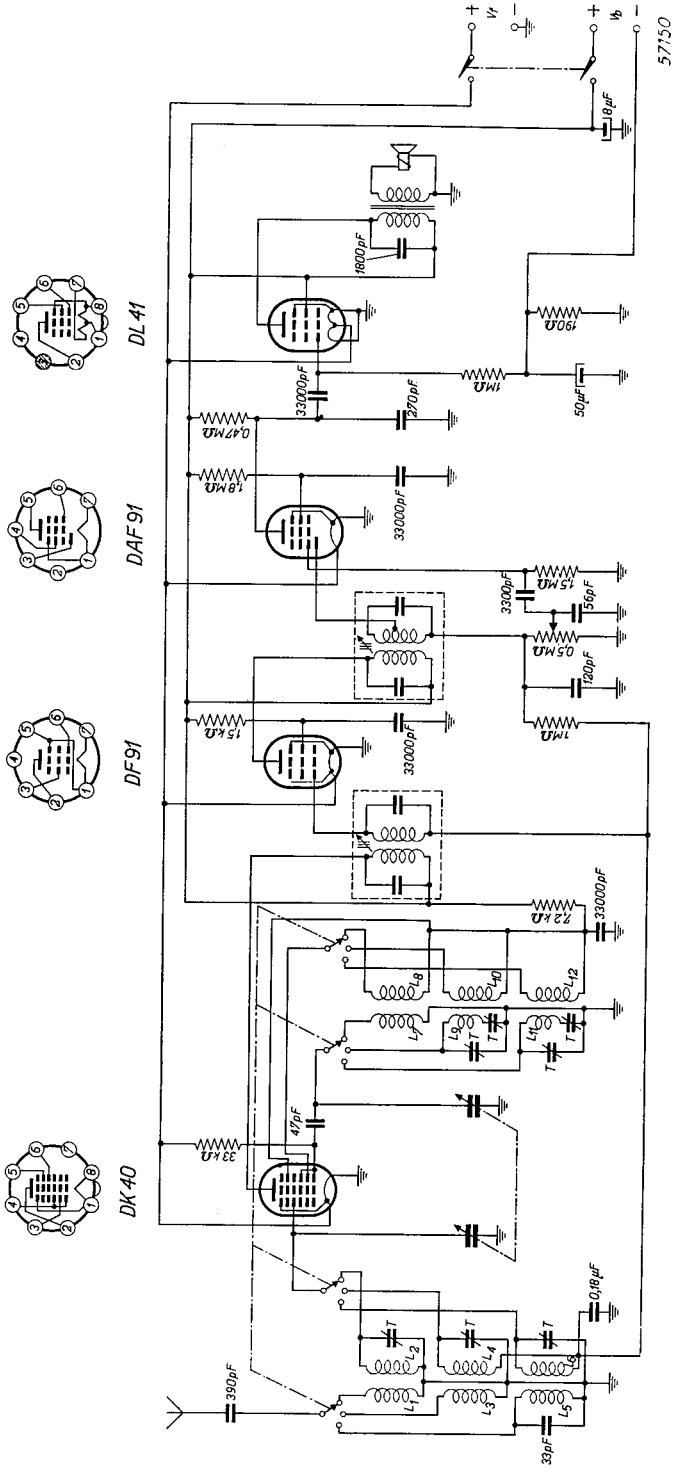

Fig. 1.
A 4-valve battery receiver.

provided by loosely coupling the wiring of the oscillator circuit to that of the R.F. input circuit. This can be effected in the following manner: First trim the receiver by means of a signal generator, then connect the R.F. circuit to an oscilloscope and trim this circuit. When the signal generator is disconnected, the deflection on the C.R. tube will be a measure of the induced oscillator voltage, and the required coupling can thus be adjusted to produce minimum deflection.

With circuits having a Q of 140, the conversion gain is approximately 80. The I.F. amplifier is the DF 91, which gives an overall amplification of 35 on weak signals (i.e. when the circuit is heavily damped by the diode), provided that the quality factor of the second I.F. transformer is also 140 and that the diode tapping on the secondary is taken at 7/10ths of the total number of turns.

The diode of the DAF 91 is used for detection, the detected signals being taken from the diode load and applied in the usual manner through a capacitor to the grid of the pentode section.

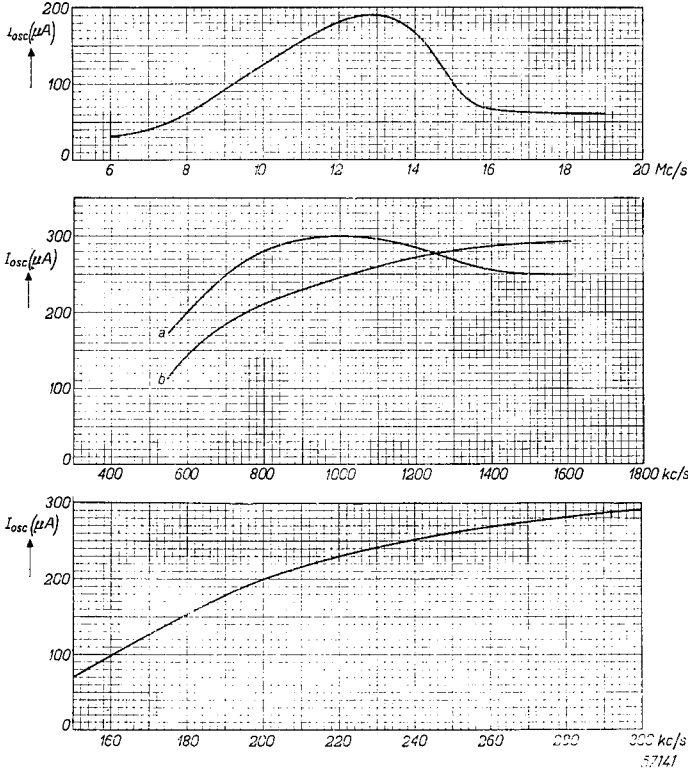

Fig. 2
Oscillator grid current of the frequency changer as a function of the frequency in each of the three wave-bands.

To secure good overall sensitivity, the working point of the DAF 91 is such as will give an amplification of about 45, but some care should be exercised in regard to the position of the valve relative to the loudspeaker, since speakers with high acoustic efficiency are liable to set up microphony if too close to the valve. Again, with a view to the possibility of microphony, the total effective gain should not be increased beyond the value indicated unless special precautions are taken (such as using an anti-microphonic valve-holder, or a vibration damper fitted over the valve).

The negative voltage across the diode load is also utilized for A.G.C. on both the I.F. valve DF 91 and the frequency changer DK 40, but, with a view to avoiding excessive frequency drift, control is not applied to the DK 40 in the short-wave band.

The DL 41 is resistance-capacity coupled to the DAF 91 in the conventional manner. As already mentioned in the introduction, the output power of the DL 41 is 320 mW with a 90 V battery, but the actual amount of power

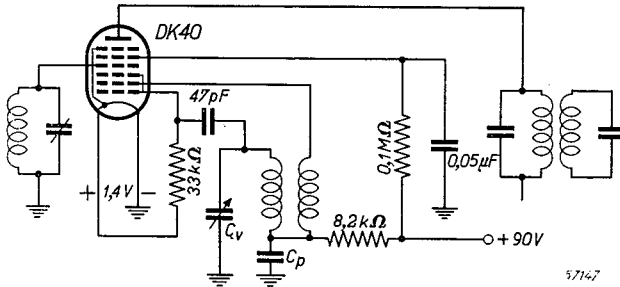

Fig. 3

The mixing stage with the reaction coil connected to the "top" of the padding capacitor to secure a more constant oscillator voltage throughout the frequency range.

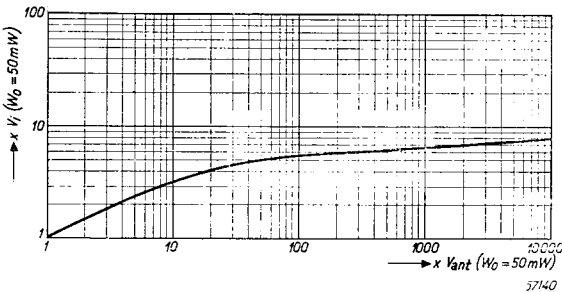

Fig. 4

A.G.C. characteristic for the circuit shown in Fig. 1.

delivered to the speech coil is naturally dependent on the quality of the speaker transformer. Grid bias for the output valve is derived from a 190 ohm resistor connected in the negative H.T. line. The total filament current is 250 mA at 1.4 V, the H.T. drain being about 18 mA with a 90 V battery. When the battery voltages drop to 1.1 V and 60 V respectively, the sensitivity is decreased by a factor of about 3.

MEASURED VALUES

Currents and voltages for a battery voltage of $V_b=90$ V

DK 40 - frequency changer

Anode voltage	V_a	=	86 V
Oscillator anode voltage	V_{g2}	=	67.5 V
Screen grid voltage	V_{g5}	=	67.5 V
Anode current	I_a	=	1 mA
Oscillator anode current	I_{g2}	=	2.8 mA
Screen grid current	I_{g5}	=	0.2 mA

DF 91 - I.F. amplifier

Anode voltage	V_a	=	86 V
Screen grid voltage	V_{g2}	=	67.5 V
Anode current	I_a	=	3.5 mA
Screen grid current	I_{g2}	=	1.5 mA

DAF 91 - diode-A.F. pentode

Anode voltage	V_a	=	25 V
Screen grid voltage	V_{g2}	=	21 V
Anode current	I_a	=	0.13 mA
Screen grid current	I_{g2}	=	0.036 mA

DL 41 - output valve

Anode and screen grid voltage	$V_a = V_{g2}$	=	86 V
Grid bias	V_{g1}	=	-3.6 V
Anode current	I_a	=	8.0 mA
Screen grid current	I_{g2}	=	1.3 mA

Sensitivity (measured at 1000 kc/s)
with a standard output power of 50 mW

At the control grid of the DL 41		1 V_{RMS}
At the control grid of the DAF 91	approx.	22 mV_{RMS}
At the detector diode (I.F.)	approx.	140 mV_{RMS}^1
At the control grid of the DF 91	approx.	7 mV_{RMS}^1
At the control grid of the DK 40	approx.	140 μV_{RMS}
At the aerial	approx.	70 μV_{RMS}

Average total selectivity

1 : 10	when the receiver is detuned	\pm 4 kc/s
1 : 100	„ „ „ „ „	\pm 10 kc/s
1 : 1000	„ „ „ „ „	\pm 20 kc/s

¹⁾ Although the gain factors of the DK 40 and DF 91 are stated to be 80 and 35 respectively, the gain in the circuit is reduced somewhat by an extra negative voltage set up by the diode contact potential.

“MINIWATT” NOVAL VALVES

In the foregoing a number of valves have been described which could be manufactured without difficulty in the Rimlock or miniature techniques. There are, however, valves which, because they employ more than eight electrode connections, cannot be made along these lines. Such valves are therefore made in a new 9-pin range, these being known as “Noval” valves. In appearance Noval valves are very similar to the miniature types, except that they are of larger diameter (max. 22 mm) and have 9 pins, at 9 points of a decagon, the tenth point being vacant. This asymmetrical spacing of the pins, also employed in miniature valves, obviates the need for a special pilot to guide the valve into its holder. The pitch circle diameter of the pins is 11.9 mm, which very nearly corresponds to that of the Rimlock valves. The Noval range so far comprises the double diode-pentodes EBF 80 and UBF 80, and the F.M. detector EQ 80, each of which is described in the following pages.

EBF 80 Double diode-variable-mu pentode

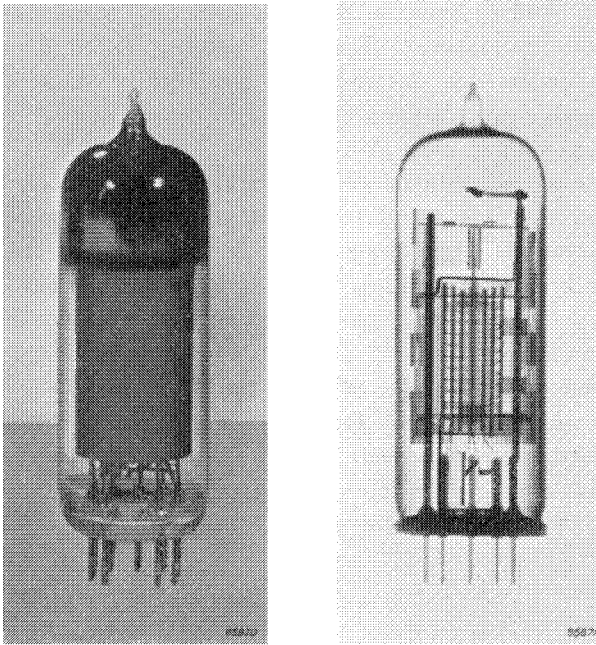

Fig. 1
Normal and X-ray photographs of the EBF 80.

The EBF 80 comprises a pentode section with a variable- μ characteristic and two diodes operating on a common cathode. The pentode system is suitable for R.F., I.F. or A.F. amplification, the slope being 2.2 mA/V, and the internal resistance 1.4 M Ω , for a grid bias of -2 V. The two diodes can be used for detection and as a voltage source for automatic gain control. In view of the fact that this valve has two diodes, it is particularly suitable for receivers containing no other diodes: delayed A.G.C. can thus be employed without any difficulty with all the advantages mentioned in the description of the EAF 42.

Examples of receivers in which the EBF 80 can be used with advantage as I.F. amplifier are as follows:

1. Simple receivers without an A.F. amplifying valve, employing, for example, the ECH 42 or ECH 41 as the frequency changer and the EL 41 as the output valve.
2. Push-pull receivers with the ECC 40 as an A.F. amplifier and phase inverter.
3. Sets in which the EF 40 is used as an A.F. amplifying valve, ensuring high A.F. amplification with low hum level and little risk of microphony.

EBF 80

- Sets suitable for receiving A.M. as well as F.M. signals, employing the EQ 80 as F.M. detector. For A.M. reception, the EQ 80 can be used as an A.F. amplifier, with the two diodes of the EBF 80 as detector and A.G.C. diode.

In order to avoid undesirable coupling, suitable screens are fitted between the diodes and the pentode section and between the electrodes of the pentode. The whole is enclosed in a screening cage to protect the valve from external influences, thus obviating the necessity for external screening.

When used as an A.F. amplifier, the EBF 80 provides a gain of 150, which represents more amplification than is usually required, and so leaves a reserve which can be used for feedback purposes. Moreover, the gain in an amplifier or receiver is usually limited by microphony; unless special precautions are taken, the gain cannot be allowed to reach a value such that, using a loudspeaker of 5% efficiency, the input signal applied to the EBF 80 is less than 25 mV for an output of 50 mW from the output valve. The full significance of this is explained in the description of the valve EAF 42.

TECHNICAL DATA OF THE DOUBLE DIODE-PENTODE EBF 80

Heater data

Heating: indirect by A.C. or D.C.; parallel feed

Heater voltage	V_f	=	6.3 V
Heater current	I_f	=	0.3 A

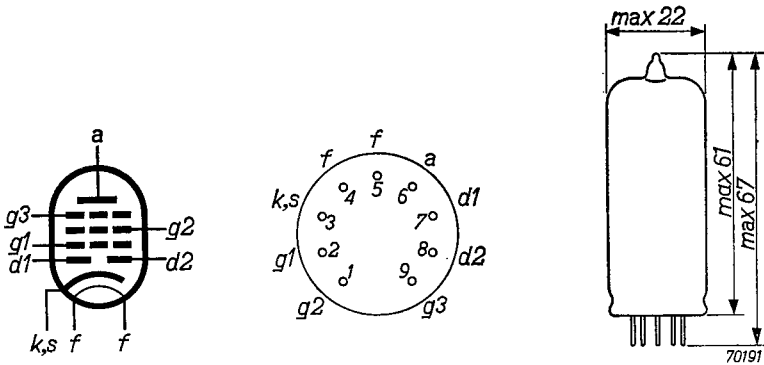

Fig. 2
Electrode arrangement, electrode connections and max. dimensions in mm of the EBF 80

Capacitances

Pentode section

Input capacitance	C_{g1}	=	4.2 pF
Output capacitance	C_a	=	4.9 pF
Control grid - anode	C_{ag1}	<	0.0025 pF
Control grid - heater	C_{g1f}	<	0.07 pF

Diode system

Diode 1 - cathode	C_{d1}	=	2.2 pF
Diode 2 - cathode	C_{d2}	=	2.35 pF
Between the diode anodes	C_{d1d2}	<	0.35 pF
Diode 1 - heater	C_{d1f}	<	0.02 pF
Diode 2 - heater	C_{d2f}	<	0.005 pF

Between the diodes and the pentode section

Diode 1 - control grid	C_{d1g1}	<	0.0008 pF
Diode 2 - control grid	C_{d2g1}	<	0.001 pF
Diode 1 - pentode anode	C_{d1a}	<	0.2 pF
Diode 2 - pentode anode	C_{d2a}	<	0.05 pF

Operating characteristics of the pentode section as R.F. or I.F. amplifier

Anode and supply voltage	$V_a = V_b$	=	250 V
Voltage on grid 3	V_{g3}	=	0 V
Screen grid resistor	R_{g2}	=	95 kΩ
Cathode resistor	R_k	=	295 Ω
Grid bias	V_{g1}	=	$\overbrace{-2 \text{ } -41.5}^{\text{V}}$
Screen grid voltage	V_{g2}	=	85 250 V
Anode current	I_a	=	5.0 — mA
Screen grid current	I_{g2}	=	1.75 — mA
Mutual conductance	S	=	2200 22 μA/V
Internal resistance	R_i	=	1.4 >10 MΩ
Amplification factor of grid No. 2 with respect to grid No. 1	μ_{g2g1}	=	18 18
Equivalent noise resistance	R_{eq}	=	6.8 — kΩ

EBF 80

Operating characteristics of the pentode section as a resistance-capacity coupled A.F. amplifier

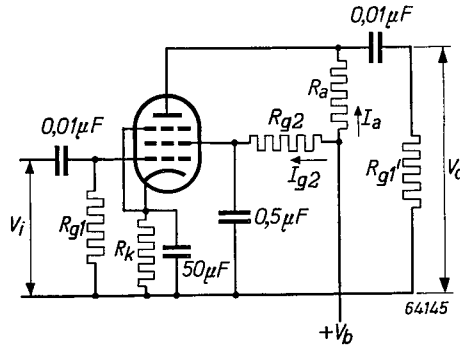

Fig. 3

Supply voltage	V_b	=	250	250	250	250	V
Anode resistor	R_a	=	0.22	0.1	0.22	0.1	MΩ
Screen grid resistor	R_{g2}	=	0.82	0.39	1.0	0.47	MΩ
Grid leak	R_{g1}	=	1	1	10	10	MΩ
Cathode resistor	R_k	=	1800	1000	0	0	Ω
Grid leak of next valve	R'_{g1}	=	0.68	0.33	0.68	0.33	MΩ
Anode current	I_a	=	0.75	1.5	0.75	1.5	mA
Screen grid current	I_{g2}	=	0.30	0.53	0.25	0.50	mA
Amplification	V_0/V_i	=	110	80	160	110	
Distortion d_{tot} at an output voltage of	$3 V_{RMS}$	=	0.75	0.9	0.8	0.8	%
	$5 V_{RMS}$	=	1.3	1.5	1.4	1.4	%
	$8 V_{RMS}$	=	2.0	2.2	2.1	2.1	%

Operating characteristics of the pentode section as a resistance-capacity coupled A.F. amplifier, triode-connected (screen grid connected to anode)

Supply voltage	V_b	=	250	250	250	250	V
Anode resistor	R_a	=	0.1	0.047	0.1	0.047	MΩ
Grid leak	R_{g1}	=	1	1	10	10	MΩ
Cathode resistor	R_k	=	820	560	0	0	Ω
Grid leak of next valve	R'_{g1}	=	0.33	0.15	0.33	0.15	MΩ
Anode current	I_a	=	2.08	4.10	2.16	4.50	mA
Amplification	V_0/V_i	=	14	13	15	15	
Distortion d_{tot} at an output voltage of	$3 V_{RMS}$	=	1.6	1.3	2.0	1.7	%
	$5 V_{RMS}$	=	2.5	2.0	3.1	2.7	%
	$8 V_{RMS}$	=	4.3	2.9	4.8	4.1	%

Limiting values of the pentode section

Anode voltage, valve biased to cut-off	V_{a_o}	= max.	550 V
Anode voltage	V_a	= max.	300 V
Anode dissipation	W_a	= max.	1.5 W
Screen grid voltage, in cut-off condition	V_{g2_o}	= max.	550 V
Screen grid voltage, valve controlled	$V_{g2}(I_a < 2.5 \text{ mA})$	= max.	300 V
Screen grid voltage, valve uncontrolled	$V_{g2}(I_a = 5 \text{ mA})$	= max.	125 V
Screen grid dissipation	W_{g2}	= max.	0.3 W
Cathode current	I_c	= max.	10 mA
Grid current starting point	$V_{g1}(I_{g1} = +0.3 \text{ } \mu\text{A})$	= max.	-1.3 V
External resistance between control grid and cathode	R_{g1}	= max.	3 M Ω ¹⁾
External resistance between heater and cathode	R_{fk}	= max.	20 k Ω
Voltage between heater and cathode	V_{fk}	= max.	100 V

Limiting values of the diode sections

Peak inverse voltage on diode No. 1	$V_{d1inv p}$	= max.	350 V
Peak inverse voltage on diode No. 2	$V_{d2inv p}$	= max.	350 V
Current to diode anode No. 1	I_{d1}	= max.	0.8 mA
Current to diode anode No. 2	I_{d2}	= max.	0.8 mA
Peak current to diode anode No. 1	I_{d1p}	= max.	5 mA
Peak current to diode anode No. 2	I_{d2p}	= max.	5 mA
External resistance between heater and cathode	R_{fk}	= max.	20 k Ω
Voltage between heater and cathode	V_{fk}	= max.	100 V

¹⁾ Applicable where grid bias is obtained from cathode resistor; if a grid leak provides the grid bias, the limiting value for R_{g1} is 22 M Ω .

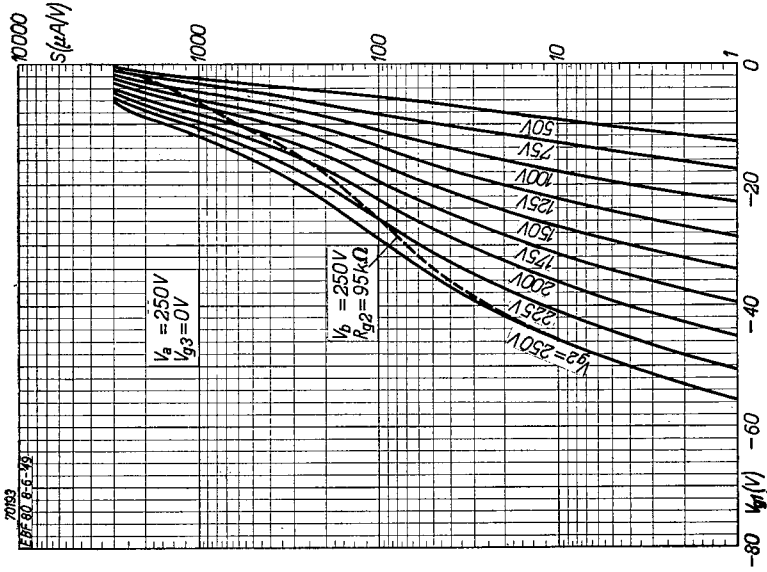

Fig. 5

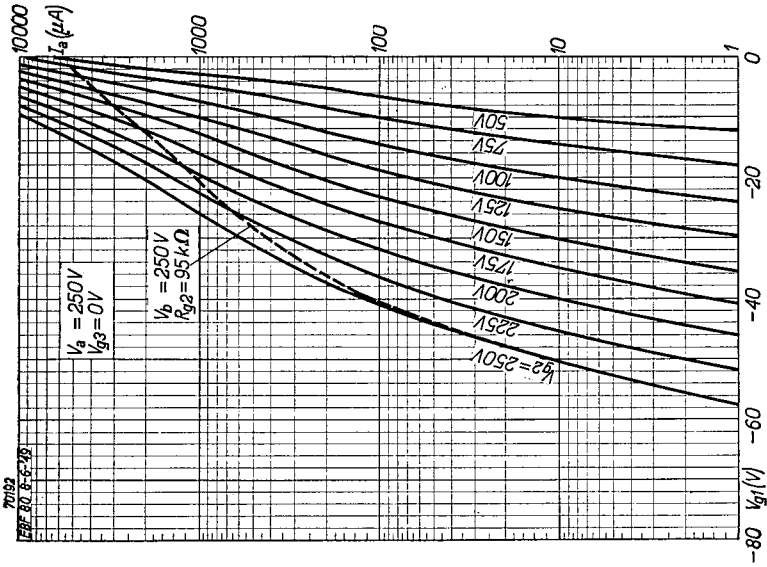

Fig. 4

Anode current (I_a , Fig. 4) and mutual conductance (S , Fig. 5) as functions of the grid bias (V_{g1}), with screen grid voltage (V_{g2}) as parameter. The broken lines represent I_a and S when a series resistor of 95 kΩ is included in the screen grid circuit.

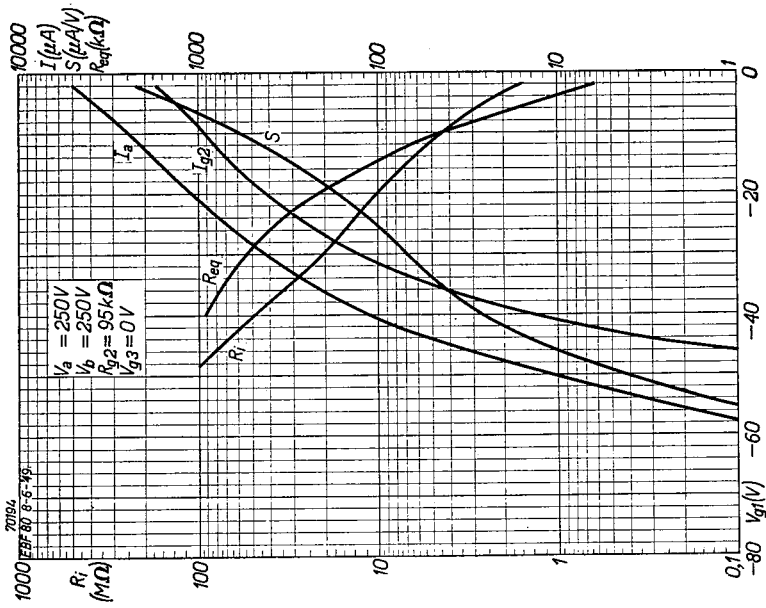

Fig. 6

Anode current (I_{a1}), screen grid current (I_{g2}), mutual conductance (S), internal resistance (R_i) and equivalent noise resistance (R_{eq}) as functions of the grid bias (V_{g1}), with $R_{g2} = 95 \text{ k}\Omega$ in the screen grid circuit.

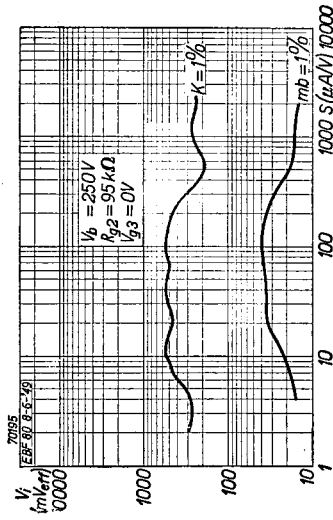

Fig. 7

- 1) Strength of an interfering signal (V_i) at the control grid producing 1% cross-modulation (curve $K=1\%$), and
- 2) strength of a ripple voltage (V_i) at the control grid producing 1% modulation hum (curve $m_b=1\%$), both as functions of the slope (S).

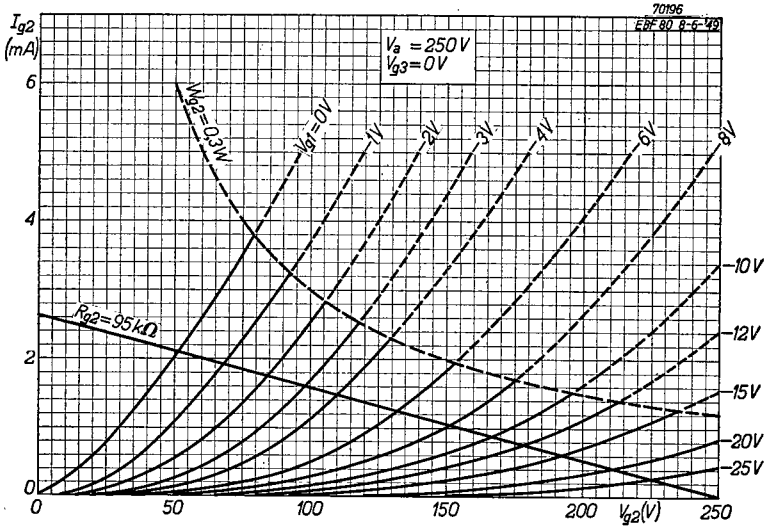

Fig. 8
Screen grid current (I_{g2}) as a function of the screen grid voltage (V_{g2}) with grid bias (V_{g1}) as parameter. The broken curve indicates the maximum permissible screen grid dissipation ($W_{g2} = 0.3W$), whilst the straight line represents the load line with a series resistor of $95k\Omega$.

UBF 80 Double diode - variable-mu pentode

The UBF 80, designed for A.C./D.C. receivers with 100 mA heater chains, contains two diodes and a variable-mu pentode. The pentode section is suitable for R.F., I.F. and A.F. amplification, the slope being about 2.2 mA/V for an anode current of 5 mA; the internal resistance is about 1 MΩ. The diodes can be used for detection and to provide the control voltage for A.G.C.

As the properties of this valve are identical with those of the EBF 80, reference may be made to the description of the latter for further details.

TECHNICAL DATA OF THE DOUBLE DIODE-PENTODE UBF 80

Heater data

Heating: indirect by A.C. or D.C.; series feed

Heater current	I_f	=	100 mA
Heater voltage	V_f	=	17 V

Capacitances (cold valve)

Pentode section

Input capacitance	C_{g1}	=	4.2 pF
Output capacitance	C_a	=	4.9 pF
Control grid - anode	C_{ag1}	<	0.0025 pF
Control grid - heater	C_{ghf}	<	0.07 pF

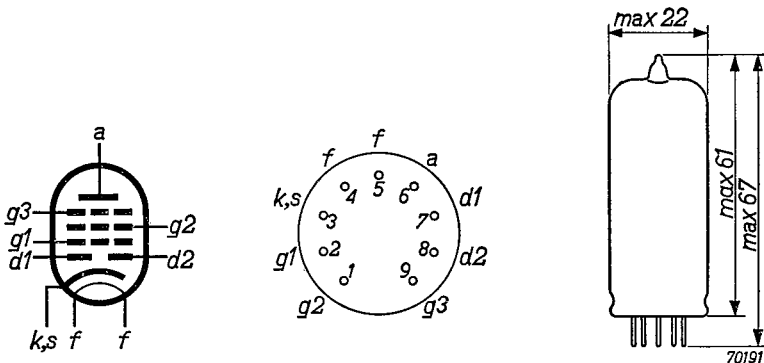

Fig. 1
Electrode arrangement, electrode connections and max. dimensions in mm of the UBF 80.

UBF 80

Diode section

Diode anode No. 1 - cathode	C_{d1}	=	2.2 pF
Diode anode No. 2 - cathode	C_{d2}	=	2.35 pF
Between diode anodes . . .	C_{d1d2}	<	0.35 pF
Diode anode No. 1 - heater	C_{d1f}	<	0.02 pF
Diode anode No. 2 - heater	C_{d2f}	<	0.005 pF

Between diodes and pentode

Diode anode No. 1 - control grid	C_{d1g1}	<	0.0008 pF
Diode anode No. 2 - control grid	C_{d2g1}	<	0.001 pF
Diode anode No. 1 - pentode anode	C_{d1a}	<	0.2 pF
Diode anode No. 2 - pentode anode	C_{d2a}	<	0.05 pF

Operating characteristics of the pentode section as R.F. or I.F. amplifier

Anode and supply voltage . .	$V_a = V_b$	=	100	170	V
Voltage on grid No. 3	V_{g3}	=	0	0	V
Screen grid resistor	R_{g2}	=	47	47	kΩ
Cathode resistor	R_k	=	295	295	Ω
Grid bias	V_{g1}	=	-1.15—15.5		-2—26.5 V
Anode current	I_a	=	2.8	5.0	mA
Screen grid current	I_{g2}	=	1.0	1.75	mA
Mutual conductance	S	=	1900	19	2200 22 μA/V
Internal resistance	R_i	=	0.9	>10	0.9 >10 MΩ
Amplification factor of grid 2 with respect to grid 1	μ_{g2g1}	=	18	18	—
Equivalent noise resistance .	R_{eq}	=	4.6	6.2	— kΩ

Anode and supply voltage	$V_a = V_b$	=	200	V
Voltage on grid No. 3	V_{g3}	=	0	V
Screen grid resistor	R_{g2}	=	68	kΩ
Cathode resistor	R_k	=	295	Ω
Grid bias	V_{g1}	=	-2 —31.5 V	
Anode current	I_a	=	5.0	— mA
Screen grid current	I_{g2}	=	1.75	— mA
Mutual conductance	S	=	2200	22 μA/V
Internal resistance	R_i	=	1.0	>10 MΩ
Amplification factor of grid 2 with respect to grid 1	μ_{g2g1}	=	18	—
Equivalent noise resistance .	R_{eq}	=	6.2	— kΩ

Operating characteristics of the pentode section as a resistance-capacity coupled A.F. amplifier

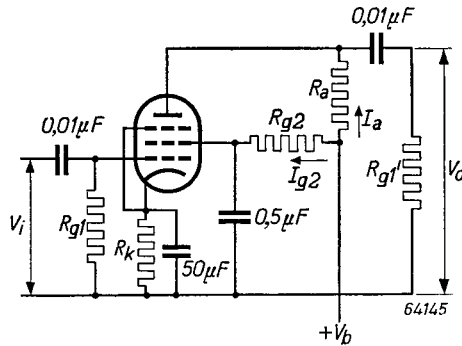

Fig. 2
The UBF 80 as an A.F. amplifier.

Supply voltage	V_b	=	170	170	170	170	V
Anode resistor	R_a	=	0.22	0.1	0.22	0.1	MΩ
Screen grid resistor	R_{g2}	=	0.68	0.27	0.82	0.33	MΩ
Grid leak	R_{g1}	=	1	1	10	10	MΩ
Cathode resistor	R_k	=	2700	1000	0	0	Ω
Grid leak of next valve	R_{g1}'	=	0.68	0.33	0.68	0.33	MΩ
Anode current	I_a	=	0.56	1.25	0.56	1.16	mA
Screen grid current	I_{g2}	=	0.20	0.50	0.19	0.46	mA
Amplification	V_o/V_i	=	85	70	140	100	
Distortion d_{tot} at an output voltage of							
	3 V_{RMS}	=	1.2	1.2	0.8	0.8	%
	5 V_{RMS}	=	1.5	1.6	1.0	1.4	%
	8 V_{RMS}	=	1.8	2.0	1.4	2.0	%

Supply voltage	V_b	=	100	100	100	100	V
Anode resistor	R_a	=	0.22	0.1	0.22	0.1	MΩ
Screen grid resistor	R_{g2}	=	0.68	0.27	0.82	0.33	MΩ
Grid leak	R_{g1}	=	1	1	10	10	MΩ
Cathode resistor	R_k	=	2700	1000	0	0	Ω
Grid leak of next valve	R_{g1}'	=	0.68	0.33	0.68	0.33	MΩ
Anode current	I_a	=	0.32	0.73	0.32	0.66	mA
Screen grid current	I_{g2}	=	0.12	0.29	0.11	0.25	mA
Amplification	V_o/V_i	=	82	67	100	70	
Distortion d_{tot} at an output voltage of							
	3 V_{RMS}	=	1.4	1.4	2.8	1.7	%
	5 V_{RMS}	=	1.9	1.8	3.0	3.2	%

UBF 80

Operating characteristics of the pentode section as a resistance-capacity coupled A.F. amplifier, triode-connected (screen grid connected to anode)

Supply voltage	V_b	=	170	170	170	170	V
Anode resistor	R_a	=	0.1	0.047	0.1	0.047	MΩ
Grid leak	R_{g1}	=	1	1	10	10	MΩ
Cathode resistor	R_k	=	1800	1000	0	0	Ω
Grid leak of next valve	R_{g1}'	=	0.33	0.15	0.33	0.15	MΩ
Anode current	I_a	=	1.25	2.4	1.4	2.8	mA
Amplification	V_o/V_i	=	11	11	14	14	
Distortion d_{tot} at an output voltage of	3 V_{RMS}	=	2.1	1.8	2.5	2.1	%
	5 V_{RMS}	=	3.5	3.1	3.8	3.4	%
	8 V_{RMS}	=	4.8	4.6	5.0	4.7	%

Supply voltage	V_b	=	100	100	100	100	V
Anode resistor	R_a	=	0.1	0.047	0.1	0.047	MΩ
Grid leak	R_{g1}	=	1	1	10	10	MΩ
Cathode resistor	R_k	=	1800	1000	0	0	Ω
Grid leak of next valve	R_{g1}'	=	0.33	0.15	0.33	0.15	MΩ
Anode current	I_a	=	0.74	1.4	0.8	1.5	mA
Amplification	V_o/V_i	=	11	11	12	12	
Distortion d_{tot} at an output voltage of	3 V_{RMS}	=	3.2	3.0	3.0	3.0	%
	5 V_{RMS}	=	4.9	4.8	4.7	4.8	%

Limiting values of the pentode section

Anode voltage, valve biased to cut-off	V_{a_o}	=	max.	550	V
Anode voltage	V_a	=	max.	250	V
Anode dissipation	W_a	=	max.	1.5	W
Screen grid voltage, valve biased to cut-off	V_{g2_o}	=	max.	550	V
Screen grid voltage, valve controlled	$V_{g2}(I_a < 2 \text{ mA})$	=	max.	250	V
Screen grid voltage, valve uncontrolled	$V_{g2}(I_a = 5 \text{ mA})$	=	max.	125	V
Screen grid dissipation	W_{g2}	=	max.	0.3	W
Cathode current	I_k	=	max.	10	mA
Grid current starting point	$V_{g1}(I_{g1} = +0.3 \mu\text{A})$	=	max.	-1.3	V
External resistance between control grid and cathode (with cathode resistor)	$R_{g1}(R_k = 295 \Omega)^1$	=	max.	3	MΩ
External resistance between heater and cathode	R_{fk}	=	max.	20	kΩ
Voltage between heater and cathode	V_{fk}	=	max.	150	V

¹⁾ If the grid bias is obtained only by means of the grid leak, the limiting value for R_{g1} is max. 22 MΩ.

Limiting values of the diode section

Peak inverse voltage on diode No. 1	$V_{d1inv p}$	= max.	350 V
Peak inverse voltage on diode No. 2	$V_{d2inv p}$	= max.	350 V
Diode No. 1 current	I_{d1}	= max.	0.8 mA
Diode No. 2 current	I_{d2}	= max.	0.8 mA
Diode No. 1 peak current	I_{d1p}	= max.	5 mA
Diode No. 2 peak current	I_{d2p}	= max.	5 mA
External resistance between heater and cathode	R_{fk}	= max.	20 k Ω
Voltage between heater and cathode	V_{fk}	= max.	150 V

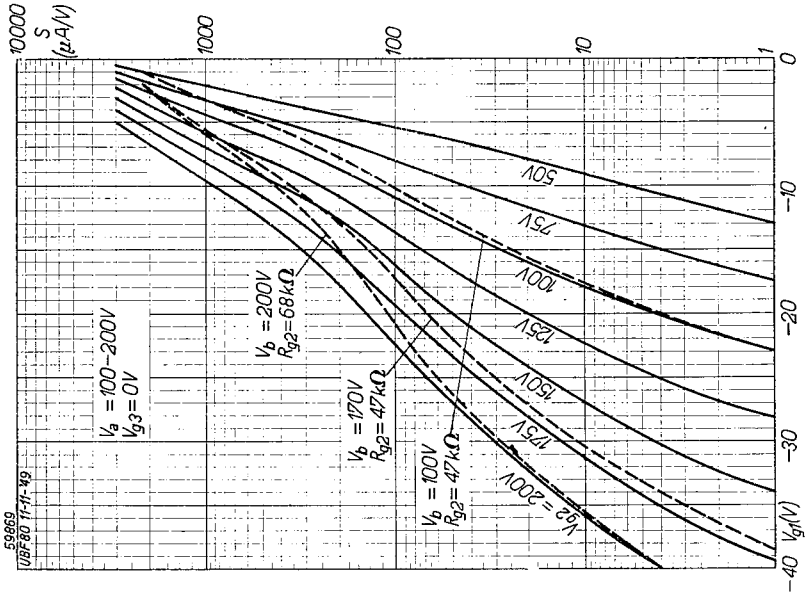

Fig. 4

as functions of the grid bias (V_{g1}), with screen supply voltages of 200, 170 and 100 V, with screen grid resistors of 68, 47 and 47 k Ω , respectively.

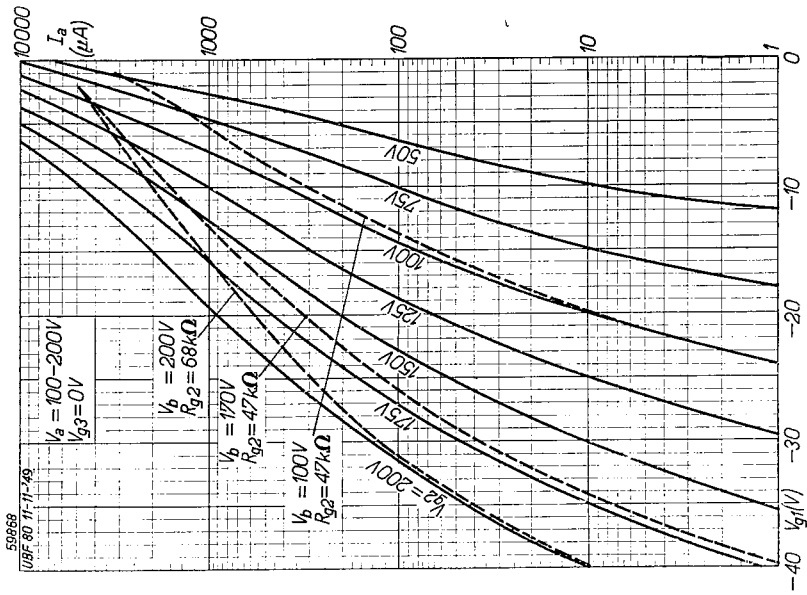

Fig. 3

as functions of the grid bias (V_{g1}), with screen supply voltages of 200, 170 and 100 V, with screen grid resistors of 68, 47 and 47 k Ω , respectively.

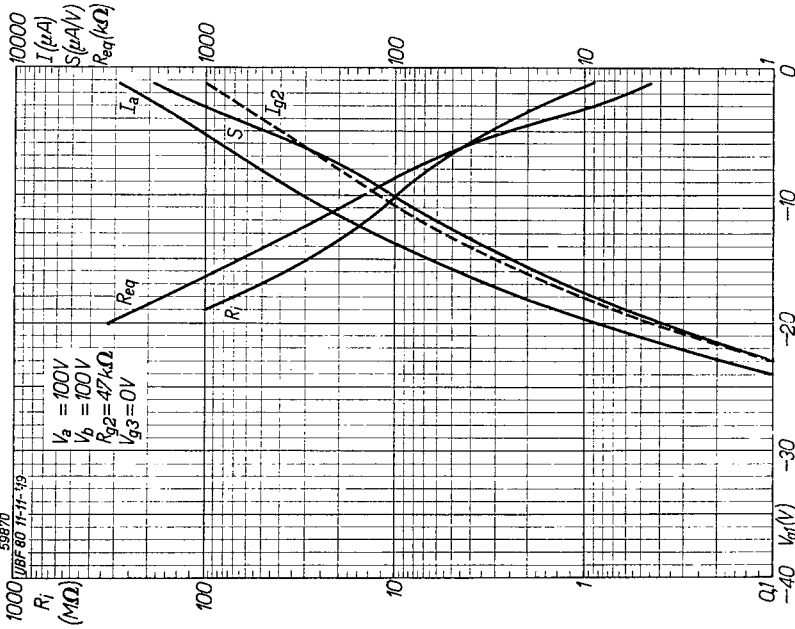

Fig. 5

Anode current (I_a), screen grid current (I_{g2}), mutual conductance (S), internal resistance (R_i) and equivalent noise resistance (R_{eq}) as functions of the grid bias (V_{g1}).

Fig. 5: Supply voltage $V_b = 100V$, screen grid resistor $R_{g2} = 47k\Omega$.

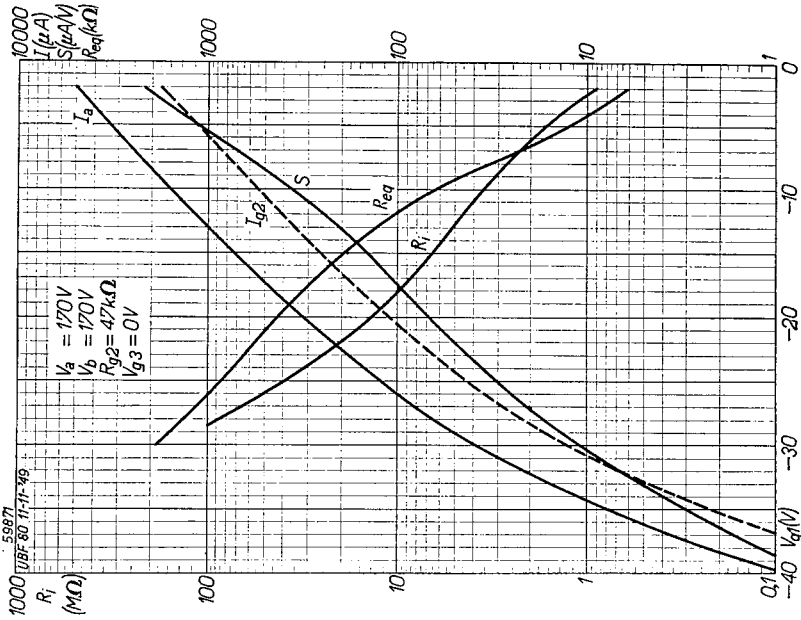

Fig. 6

Anode current (I_a), screen grid current (I_{g2}), mutual conductance (S), internal resistance (R_i) and equivalent noise resistance (R_{eq}) as functions of the grid bias (V_{g1}).

Fig. 6: Supply voltage $V_b = 170V$, screen grid resistor $R_{g2} = 47k\Omega$.

UBF 80

Fig. 7. 1) The strength of an interfering signal (V_i) at the control grid producing 1% cross-modulation (curve $K=1\%$) and 2) The strength of a ripple voltage (V_i) at the control grid producing 1% modulation hum (curve $mb=1\%$), both as functions of the mutual conductance (S). Upper diagram: $V_b=100$ V. Lower diagram: $V_b=170$ V.

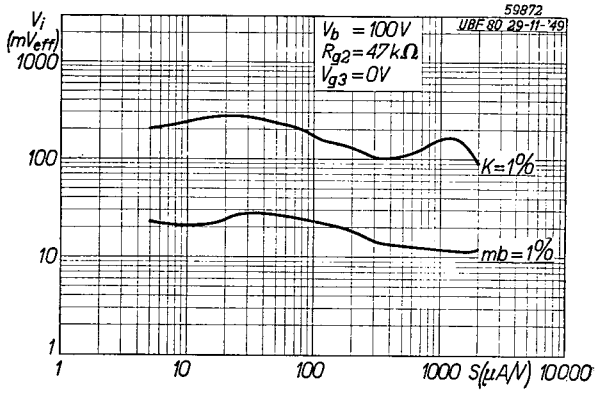
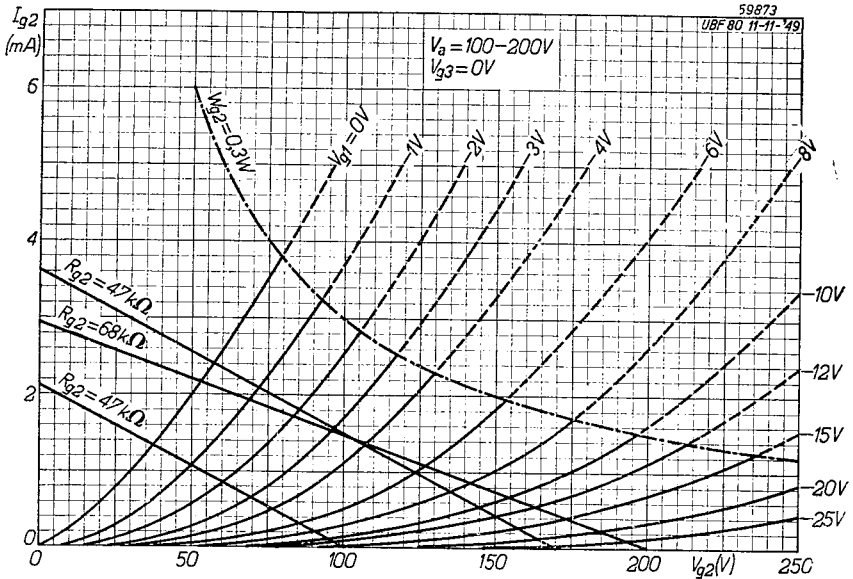
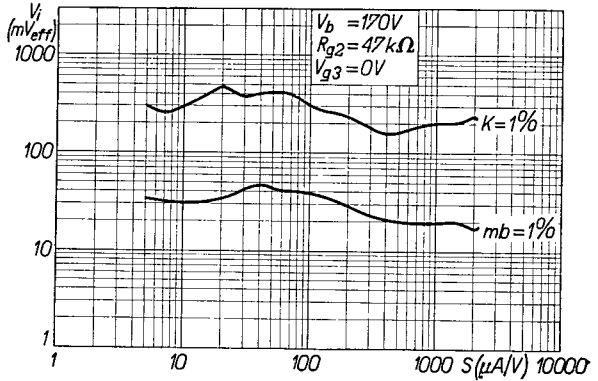

Fig. 8 Screen grid current (I_{g2}) as a function of the screen grid voltage (V_{g2}), with grid bias (V_{g1}) as parameter. The broken line indicates the maximum permissible screen grid dissipation ($P_{g2} = 0.3$ W). The load lines for 68 kΩ at $V_b=200$ V, 47 kΩ at $V_b=170$ V and 47 kΩ at $V_b=100$ V are also shown.



EQ 80 Enneode

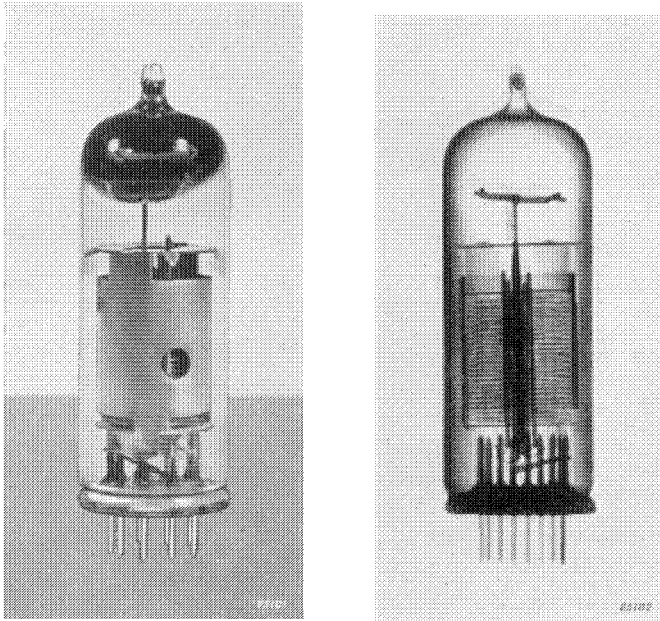

Fig. 1
Normal and X-ray photographs of the EQ 80 (approximately
actual size).

The EQ 80 is an enneode, comprising a cathode, 7 grids and an anode. The fact that some of the grids are interconnected has made it possible to mount the electrode system on a standard Noval base. This valve is intended for use as detector and, at the same time, as amplitude limiter, in F.M. receivers. The principle on which this valve works differs fundamentally from that of all other known systems, in which frequency variations are transformed into amplitude variations for detection in the conventional manner. In the EQ 80, a constant cathode current is influenced by two control grids in such a way that the anode current varies in accordance with the difference in phase between the two control voltages.

In order to give a clear picture of the detection process, it is essential first to describe the design of the valve and the functions of the different grids. The cathode current first passes grid g_1 , which in the F.M. detector is at the same potential as the cathode. The second grid is a screen grid whose potential is roughly 20 V above that of the cathode. Grids g_3 and g_5 are control grids, separated by a screen grid g_4 , which is connected to the other screen grids, g_2 and g_6 . The last grid, g_7 , is a suppressor grid, which gives the

EQ 80

valve the characteristics of a pentode. The electron current is accordingly governed almost exclusively by the voltage on the second grid, assuming a constant voltage on the first grid. The distribution of current among g_2 and the subsequent electrodes is determined by the potentials of the control grids g_3 and g_5 ; as long as g_3 is sufficiently negative, the electrons flow to g_2 , but as soon as it becomes slightly positive, the electrons pass through g_2 . In view of the fact that the cathode current is determined mainly by the screen grid voltage, an increase in the positive potential of g_3 (naturally within limits) has little or no effect on the total flow of current; the same applies to control grid g_5 .

Briefly, then, the electrons reach the anode only if grids 3 and 5 are both positive with respect to the cathode, although the actual values of V_{g3} and V_{g5} have little effect on the value of the cathode current.

When the valve is used as an F.M. detector, the alternating voltages applied to g_3 and g_5 are of like amplitude, but the difference between their respective phase angles is proportional to the frequency variation. At sufficiently high amplitudes, a current will flow in the anode circuit of which the average value is determined by the phase difference between the alternating voltages on g_3 and g_5 .

This may be seen from Fig. 3, in which V_{g3} , V_{g5} and the anode current are reproduced as functions of time. The shaded area *I* represents the waveform of the anode current for a phase difference $\varphi=50^\circ$, *II* for $\varphi=90^\circ$ and *III* for $\varphi=130^\circ$. The trapezoidal form of these areas is due to the fact that the alternating grid voltages do not immediately cause the anode current to rise from 0 to maximum.

Fig. 4 shows the EQ 80 used as an F.M. detector. The two circuits of the

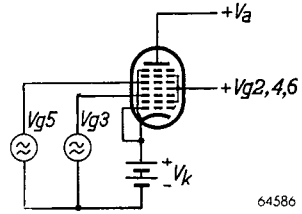

Fig. 2
Control and supply voltages for the EQ 80.

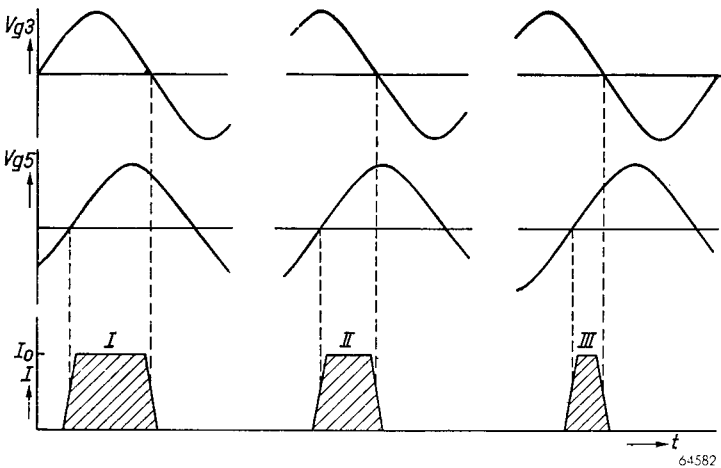

Fig. 3
Alternating input voltages V_{g3} and V_{g5} and average anode current as functions of time.

last I.F. transformer supply the two control voltages; without modulation, these voltages show a phase displacement of 90° , but, with modulation, φ varies in accordance with the frequency variation. This produces an A.F. alternating voltage across the resistor R_4 . The parasitic capacitance in the anode circuit (approx. 25 pF) is in itself sufficient to bypass the high frequency components of the anode current.

Closer investigation now reveals that the variation in φ is not exactly proportional to the frequency shift: the relationship between the phase angle φ and the frequency variation is actually rendered by an arc cot. curve, as depicted in Fig. 5. The figure also shows that the distortion is dependent on the Q of the secondary circuit of the preceding I.F. transformer and on the relative

frequency variation. The highest permissible quality factor for the secondary circuit at a given maximum frequency swing can therefore be determined on the basis of the maximum permissible distortion. To give a practical example, let the intermediate frequency f be 10 Mc/s, the max. frequency swing $\Delta f = 75$ kc/s and the permissible distortion 2.5%. In this case, $Q_2 \frac{\Delta f}{f} = 0.3$, yielding a value of 40 for Q_2 . The maximum frequency swing of 75 kc/s occurs only seldom in transmission, however, and an average

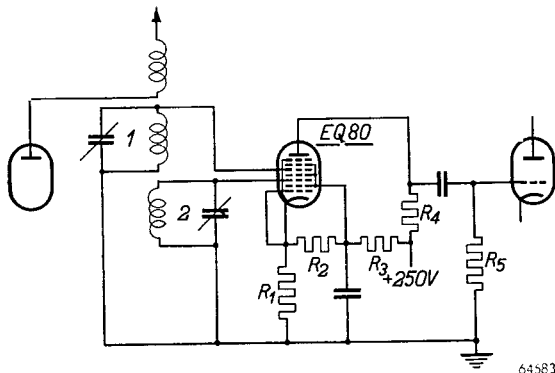

Fig. 4
The EQ 80 used as F.M. detector.

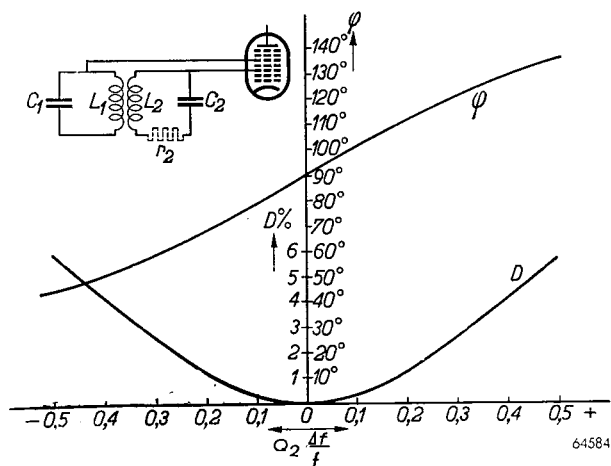

Fig. 5
The phase angle φ and the total distortion D as a function of the relation $Q_2 \Delta f/f$.

EQ 80

variation of not more than 30 kc/s can be safely assumed, the distortion being then very much less.

To avoid detection interference which may be present in the form of amplitude modulation, an amplitude limiter should precede the detector in an F.M. receiver. The EQ 80 automatically functions as such when the alternating input voltages on g_3 and g_5 are at least $8 V_{RMS}$. This is clearly illustrated in Fig. 6, in which the anode current is reproduced as a function of the alternating grid voltage for various values of the phase angle φ between V_{g3} and V_{g5} . At $V_{g3} = V_{g5} = 8 V_{RMS}$ the anode current is indeed almost independent of the alternating grid voltage.

Fig. 7 shows the anode current as a function of the phase angle φ ; the variation in anode current accompanying any given variation in the phase angle can be ascertained from this curve. The average anode current for zero modulation (i.e. $\varphi = 90^\circ$) is 0.28 mA. If the phase angle varies between 60° and 120° , the anode current will vary from 0.35 mA to 0.2 mA. The alternating anode current is therefore

$$\frac{0.35 - 0.2}{2\sqrt{2}} = 0.0537 \text{ mA.}$$

With an optimum load of $0.47 \text{ M}\Omega$ and a $0.7 \text{ M}\Omega$ grid leak for the next, i.e. the output valve, this yields an alternating output voltage of about $15 V_{RMS}$. Considering that the output valve EL 41 is fully loaded on an alternating grid voltage of not more than 5 V, it will be seen that the available output voltage is more than enough, and even provides a small reserve for feedback purposes.

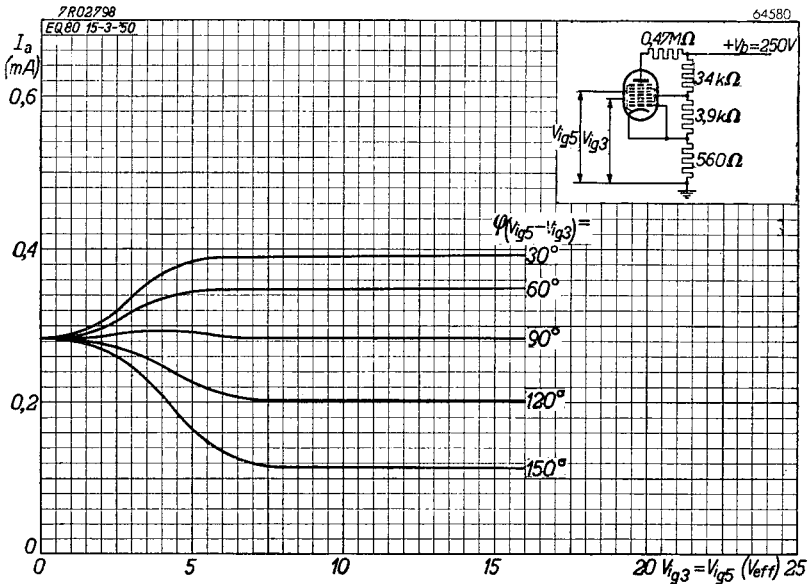

Fig. 6

Anode current of the EQ 80 as a function of the alternating input voltages applied to grids 3 and 5, for different values of the phase angle φ .

An extra pre-amplifier between the EQ 80 and the output valve is therefore not required.

In view of the fact that detection is possible also at the flanks of the discriminator curve, in which range the transmitted signal is usually distorted and the EQ 80 is more sensitive to microphony, it may be advisable to employ an optical tuning indicator and/or "silent tuning" to ensure accurate tuning of the set. This can be done quite simply by using the extra diode, usually available in one of the valves, in the manner shown in Fig. 8 (see also page 435).

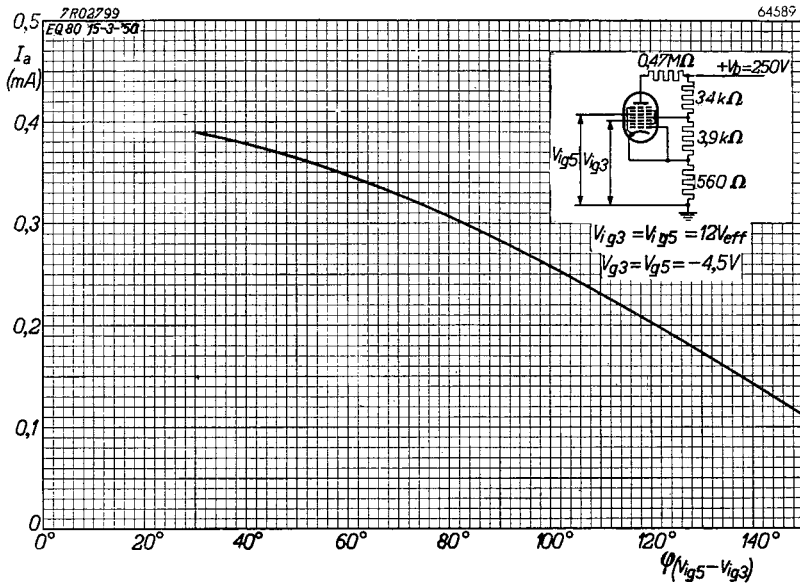

Fig. 7

Anode current of the EQ 80 as a function of the phase angle φ , with $V_{ig5} = V_{ig5} = 12 V_{RMS}$.

The basis of this method is an auxiliary voltage which peaks sharply at the appropriate tuning frequency, this voltage being detected and applied to the tuning indicator, or to a triode providing the silent tuning. Since the selectivity curve of the I.F. transformer has no sharp peak, but is flat-topped, a high-quality circuit ($L_4 C_4$) is coupled to the circuit $L_2 C_2$ by means of an earthed capacitor (C_k).

The voltage across C_4 is rectified by the diode and is applied to the control grid of the triode section of the EM 34; this triode can also be used for the silent tuning.

In the absence of a signal, the grid voltage of the EM 34 is 0 V, and the voltage on the triode anode is 20—30 V, but when the grid becomes negative owing to the rectified signal voltage, the anode voltage rises. A certain proportion of this voltage is applied to the first grid of the EQ 80 by means of R_1, R_2 .

EQ 80

In the absence of a signal the EQ 80 is biased to cut-off, the F.M. detector being then inoperative, but on reception of a signal, a positive voltage is applied to the first grid of this valve, so that the detector comes into operation when the set is tuned. If the receiver is not fitted with the tuning indicator EM 34, the triode of another valve, say the ECH 42 or ECH 21, can of course be utilized for this purpose. Moreover, the rectified voltage can, if necessary, be taken to the first grid of the EQ 80 without previous amplification.

In A.M./F.M. receivers capable of receiving amplitude-modulated as well as frequency-modulated signals, the EQ 80 may be used as an A.F. pentode for the A.M. signals, the first grid then functioning as control grid, whilst grids 3 and 5 are connected to the screen grids 2, 4 and 6. In this case the sensitivity must be restricted to 25 mV to avoid microphony.

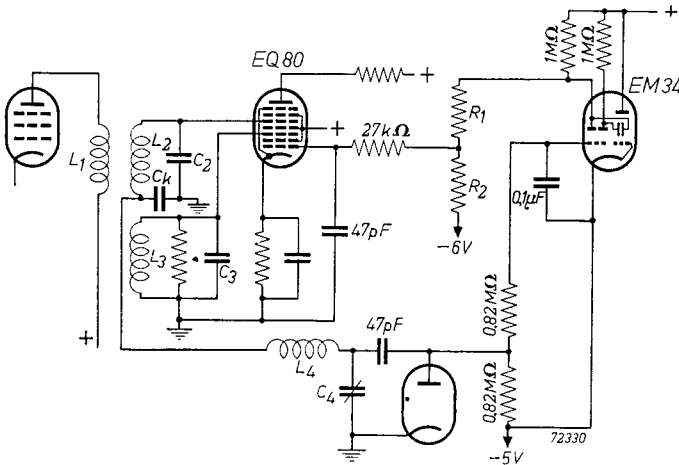

Fig. 8

Circuit of the EQ 80 used as F.M. detector with silent tuning.

TECHNICAL DATA OF THE ENNEODE EQ 80

Heater data

Heating: indirect by A.C. or D.C.; parallel feed
 Heater voltage V_f = 6.3 V
 Heater current I_f = 0.2 A

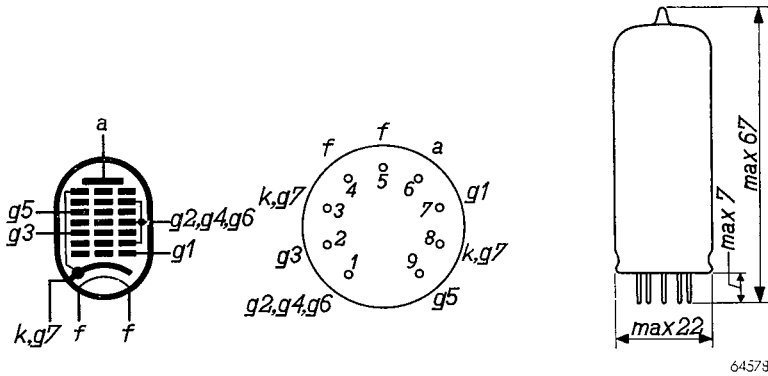

Fig. 9

Electrode arrangement, electrode connections and max. dimensions in mm of the EQ 80.

Capacitances (cold valve)

Input capacitance grid No. 1	C_{g1}	=	4.2 pF
Input capacitance grid No. 3	C_{g3}	=	5.8 pF
Input capacitance grid No. 5	C_{g5}	=	8.2 pF
Output capacitance	C_a	=	8.7 pF
Anode - grid No. 1	C_{ag1}	<	0.4 pF
Anode - grid No. 3	C_{ag3}	<	0.15 pF
Anode - grid No. 5	C_{ag5}	<	0.35 pF
Grid No. 3 - grid No. 5	C_{g3g5}	<	0.4 pF
Heater - grid No. 1	C_{g1f}	<	0.2 pF
Heater - grid No. 3	C_{g3f}	<	0.15 pF
Heater - grid No. 5	C_{g5f}	<	0.15 pF

Operating characteristics as F.M. detector and amplitude limiter (Fig. 10)

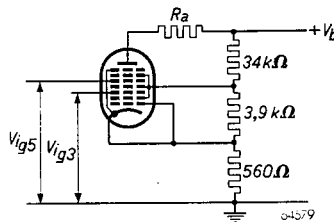

Fig. 10

The EQ 80 used as F.M. detector.

EQ 80

Supply voltage	V_b	=	250 V
Screen grid voltage	$V_{g2+g4+g6}$	=	20 V
Grid bias, grids 3 and 5	$V_{g3} = V_{g5}$	=	-4 V
Alternating input voltage to grids 3 and 5	$V_{ig3} = V_{ig5}$	=	12 V_{RMS}
Phase displacement between alternating input voltages V_{ig3} and V_{ig5}	φ	=	90 °
Anode resistor	R_a	=	0.47 M Ω
Anode current	I_a	=	0.28 mA
Screen grid current	$I_{g2+g4+g6}$	=	1.5 mA
Current to grid 3	I_{g3}	=	0.09 mA
Current to grid 5	I_{g5}	=	0.03 mA
Internal resistance	R_i	=	5 M Ω

No special measures need be taken to avoid microphony if the alternating input voltage to the next valve is at least 1 V_{RMS} for an output power of 50 mW.

Operating characteristics as A.F. amplifier (Fig. 11)

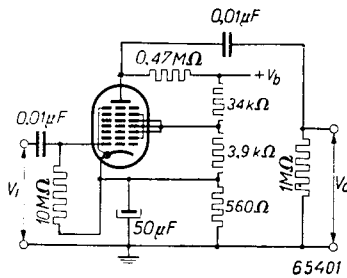

Fig. 11
The EQ 80 used as A.F. amplifier.

Supply voltage	V_b	=	250 V
Anode current	I_a	=	0.28 mA
Total distortion with an alternating output voltage of 15 V_{RMS}	d_{tot}	=	2.8 %
Amplification	V_o / V_i	=	150

Limiting values

Anode voltage, valve biased to cut-off	V_{a_o}	= max.	550 V
Anode voltage	V_a	= max.	300 V

Anode dissipation	W_a	= max. 0.1 W
Screen grid voltage, valve biased to cut-off	$V_{(g2+g4+g6)_0}$	= max. 250 V
Screen grid voltage	$V_{g2+g4+g6}$	= max. 100 V
Screen grid dissipation	$W_{g2+g4+g6}$	= max. 0.1 W
Cathode current	I_k	= max. 3 mA
Grid current starting point	$V_{g1}(I_{g1} = +0.3 \mu A)$	= max. -1.3 V
	$V_{g3}(I_{g3} = +0.3 \mu A)$	= max. -1.3 V
	$V_{g5}(I_{g5} = +0.3 \mu A)$	= max. -1.3 V
External resistance, grid 1 to cathode	R_{g1}	= max. 1 MΩ*
External resistance, grid 3 to cathode	R_{g3}	= max. 3 MΩ
External resistance, grid 5 to cathode	R_{g5}	= max. 3 MΩ
External resistance, heater to cathode	R_{fk}	= max. 20 kΩ
Voltage between heater and cathode	V_{fk}	= max. 100 V

*) If the working point of the valve is determined only by the voltage drop across the grid leak, the maximum value for R_{g1} may be increased to 22 MΩ. A maximum of 1 MΩ is applicable only if a cathode resistor is used.

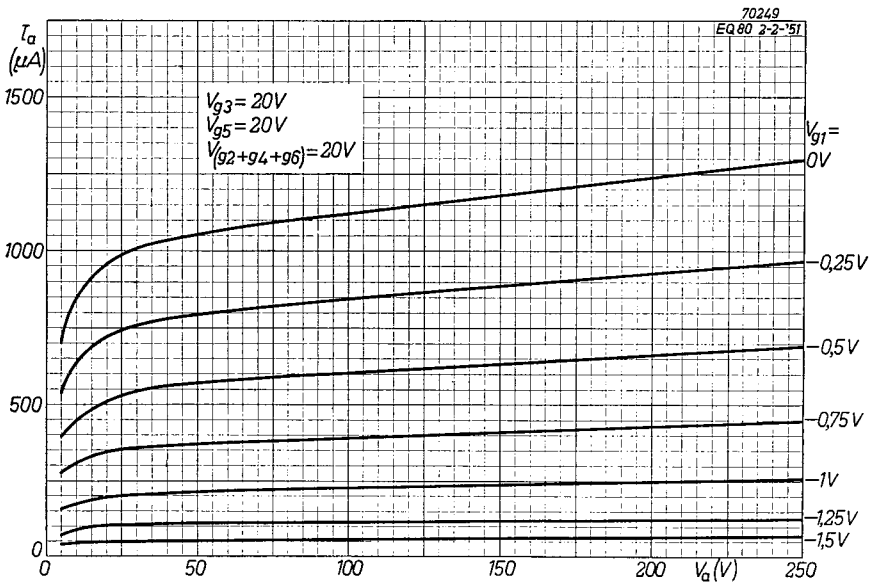

Fig. 12

Anode current as a function of the anode voltage, with V_{g1} as parameter.

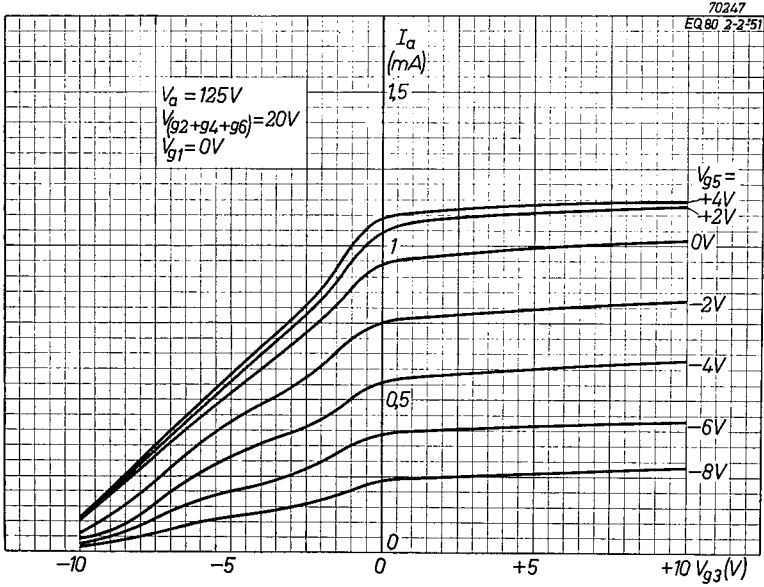

Fig. 13
Anode current as a function of the voltage on grid 3, with V_{g_5} as parameter.

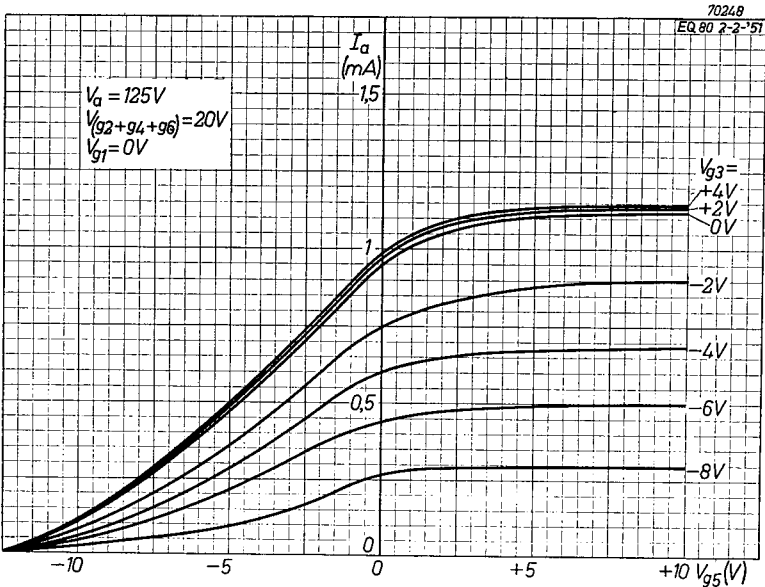

Fig. 14
Anode current as a function of the voltage on grid 5, with V_{g_3} as parameter.

XIV. A 4-valve A.C. superheterodyne receiver with reflex circuit

Introduction

The following valves are employed in this model :

ECH 42 — triode-hexode frequency changer,

EBF 80 — duodiode-pentode for detection, I.F. and A.F. amplification,

EL 41 — output pentode,

AZ 41 — full-wave rectifying valve.

In order to obtain sufficient sensitivity without a separate A.F. amplifying valve, the pentode section of the EBF 80 is used for both A.F. and I.F. amplification, this being made possible by using a reflex circuit. An aerial sensitivity of about $5 \mu\text{V}$ is thus obtained.

The receiver is designed for the following wave-bands:

long waves :	715—2190 m,
medium waves :	185— 590 m,
short waves ·	16— 53 m.

CIRCUIT DESCRIPTION

The aerial coupling and mixing stage

Both the aerial coupling and the circuit of the mixing stage are practically identical with those shown in circuit I.

The I.F., detection and A.F. stages

The voltage across the second circuit of the first I.F. transformer is applied to the control grid of the pentode section of the EBF 80.

After detection, the A.F. signal is returned to the control grid of the EBF 80 through a potentiometer of $0.5 \text{ M}\Omega$, a $22,000 \text{ pF}$ capacitor and a $22,000 \text{ ohm}$ resistor, and is amplified a second time in the pentode section of that valve.

The amplified A.F. signal is then taken from a $10,000 \text{ ohm}$ resistor connected in series with the first I.F. transformer circuit, and is applied to the control grid of the output valve EL 41 through a $22,000 \text{ pF}$ coupling capacitor.

In reflex circuits, parasitic feedback must be avoided at all cost, and to this end two extra decoupling capacitors of 1000 pF are connected across the anode coupling resistor and grid leak of the EL 41. This fact should also be borne in mind when wiring the set.

The I.F. and A.F. gain factors of the EBF 80 are so differentiated that the greatest gain occurs in the I.F. stage; the A.F. gain is intentionally limited to about 15 in order to avoid running into too much distortion. In view of the fact that the EBF 80 may operate as an anode detector when the receiver is tuned in to a powerful, e.g. local, transmitter, with the possible result that, independent of the position of the volume control, an A.F. voltage remains across the anode resistor of this valve, a switch is provided to render the reflex action, that is, the extra A.F. amplification, inoperative. Aerial sensitivity is then about $45 \mu\text{V}$.

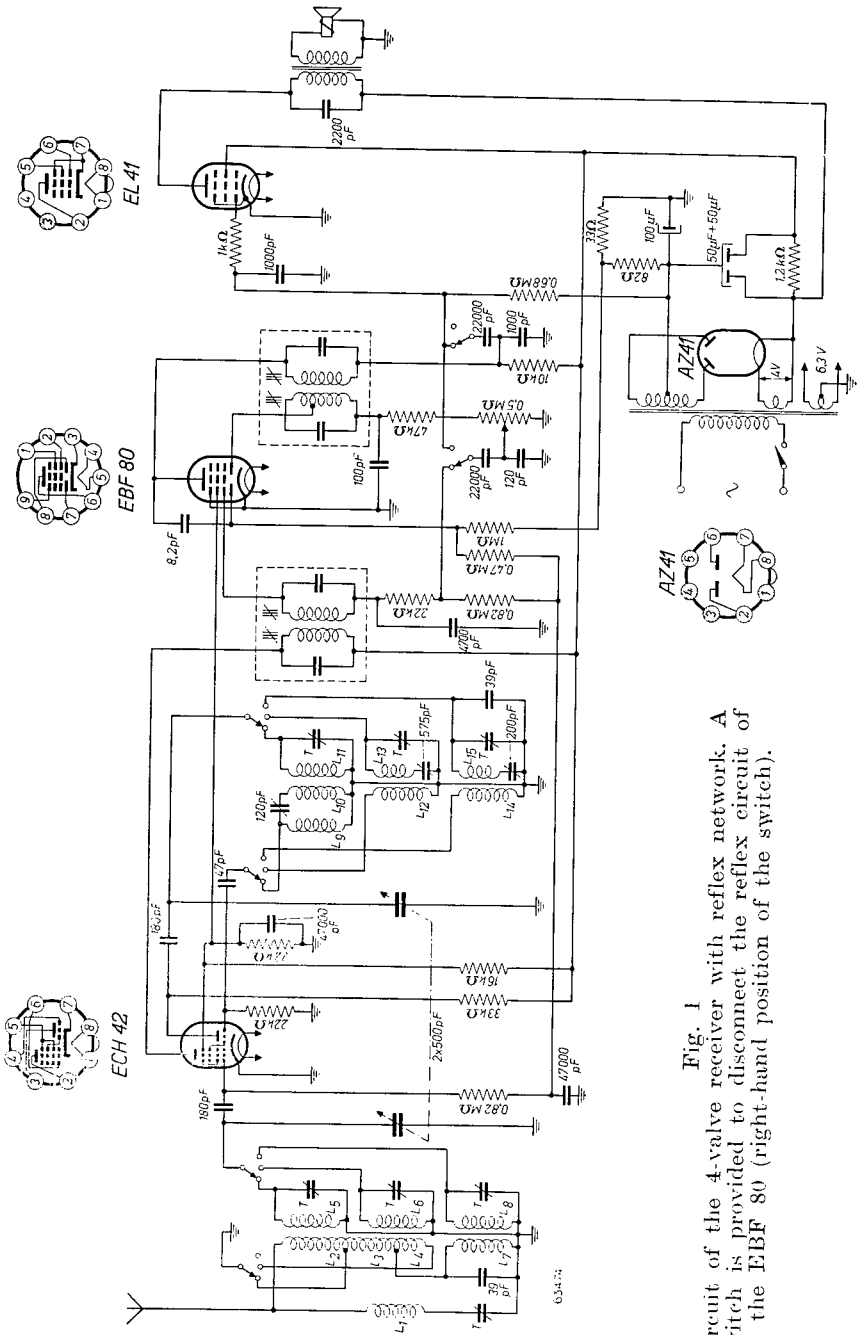

Fig. 1
 Circuit of the 4-valve receiver with reflex network. A switch is provided to disconnect the reflex circuit of the EBF 80 (right-hand position of the switch).

The output stage and power section

The output valve EL 41 delivers about 3.2 W to the speech coil. A conventional feed arrangement is employed. Two resistors, of 82 and 33 ohms, included in the negative line, provide the necessary biasing voltages.

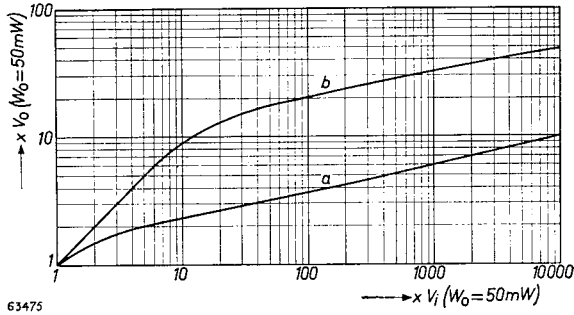

Fig. 2
A.G.C. characteristic of the receiver: a) with and b) without reflex circuit.

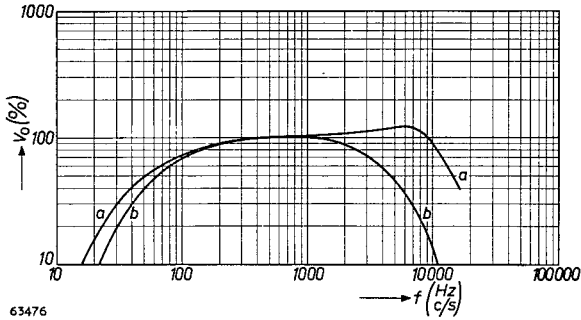

Fig. 3
A.F. response characteristics of the receiver: b) with, and a) without reflex circuit.

MEASURED VALUES

Voltages and currents

Voltage across first smoothing capacitor :	292 V
Voltage across second smoothing capacitor :	257 V
Voltage across the resistors (82 + 33 Ω) in the negative line :	7 V

EL 41 - output valve

V_a	= 250 V	I_a	= 37 mA
V_{g2}	= 250 V	I_{g2}	= 4.5 mA

EBF 80 - I.F. and A.F. valve

V_a	= 203 V	I_a	= 4.5 mA
V_{g2}	= 78 V	I_{g2}	= 1.5 mA
V_{g1}	= -1.6 V		

ECH 42 - frequency changer

(hexode section)			
V_{aH}	= 249 V	I_{aH}	= 2 mA
$V_{(g2+g4)}$	= 78 V	$I_{(g2+g4)}$	= 3.3 mA
V_{g1}	= -1.6 V		
(triode section)			
V_{aT}	= 130 V	I_{aT}	= 3.7 mA

Sensitivity

The sensitivity of the various stages is measured with an output power of 50 mW as delivered by the output valve. On R.F., measurements are effected with a signal modulated at 400 c/s to a depth of 30%.

	Sensitivity	
	at low sensitivity setting	with reflex circuit
At the control grid of the EL 41	360 mV _{RMS}	360 mV _{RMS}
At the control grid of the EBF 80 (AF)	—	24 mV _{RMS}
At the control grid of the EBF 80 (IF)	26 mV _{RMS}	3 mV _{RMS}
At the control grid of the ECH 42	200 μV _{RMS}	23 μV _{RMS}
At the aerial	45 μV _{RMS}	5 μV _{RMS}

Overall sensitivity at 1000 kc/s

Attenuation : 1 : 10	when the receiver is detuned ±	4.5 kc/s
1 : 100	when the receiver is detuned ±	8.25 kc/s
1 : 1000	when the receiver is detuned ±	12.5 kc/s

XV. A 5-valve A.C. mains superheterodyne receiver

The five valves and their functions are as follows :

- ECH 42 — frequency changer,
- EBF 80 — I.F. valve with diodes for detection and A.G.C.,
- EF 40 — A.F. valve,
- EL 41 — output valve,
- AZ 41 — full-wave rectifying valve.

In this model the aerial coupling and mixing stage are identical with those shown in circuit I. The I.F. amplifying valve is the EBF 80 with its two diodes, one of which is used for detection, and the other to supply the A.G.C. voltage. From the point of view of residual signals, it is better to incorporate these diodes in the I.F. amplifier than in the A.F. valve (see also remarks contained in the chapter dealing with the description of circuit I). The rectified signal is applied to the grid of the A.F. valve EF 40 through a combined tone control which is described in Chapter VI.

High quality of the A.F. stage is ensured by the EF 40, which produces very little hum and possesses excellent properties from the standpoint of microphony. The quality of this stage is further improved by feedback from the speech coil to the cathode of the EF 40.

MEASURED VALUES

Voltages and currents

Valve	Anode voltage (V)	Screen grid voltage (V)	Grid bias (V)	Anode current (mA)	Screen grid current (mA)
ECH 42					
Hexode	258	74	—2.1	3	4.6
Triode	130	—	—	3.4	—
EBF 80	258	68	—2.1	4.7	1.35
EF 40	100	84	—1.9	0.72	0.13
EL 41	238	253	—6.8	37	5.6

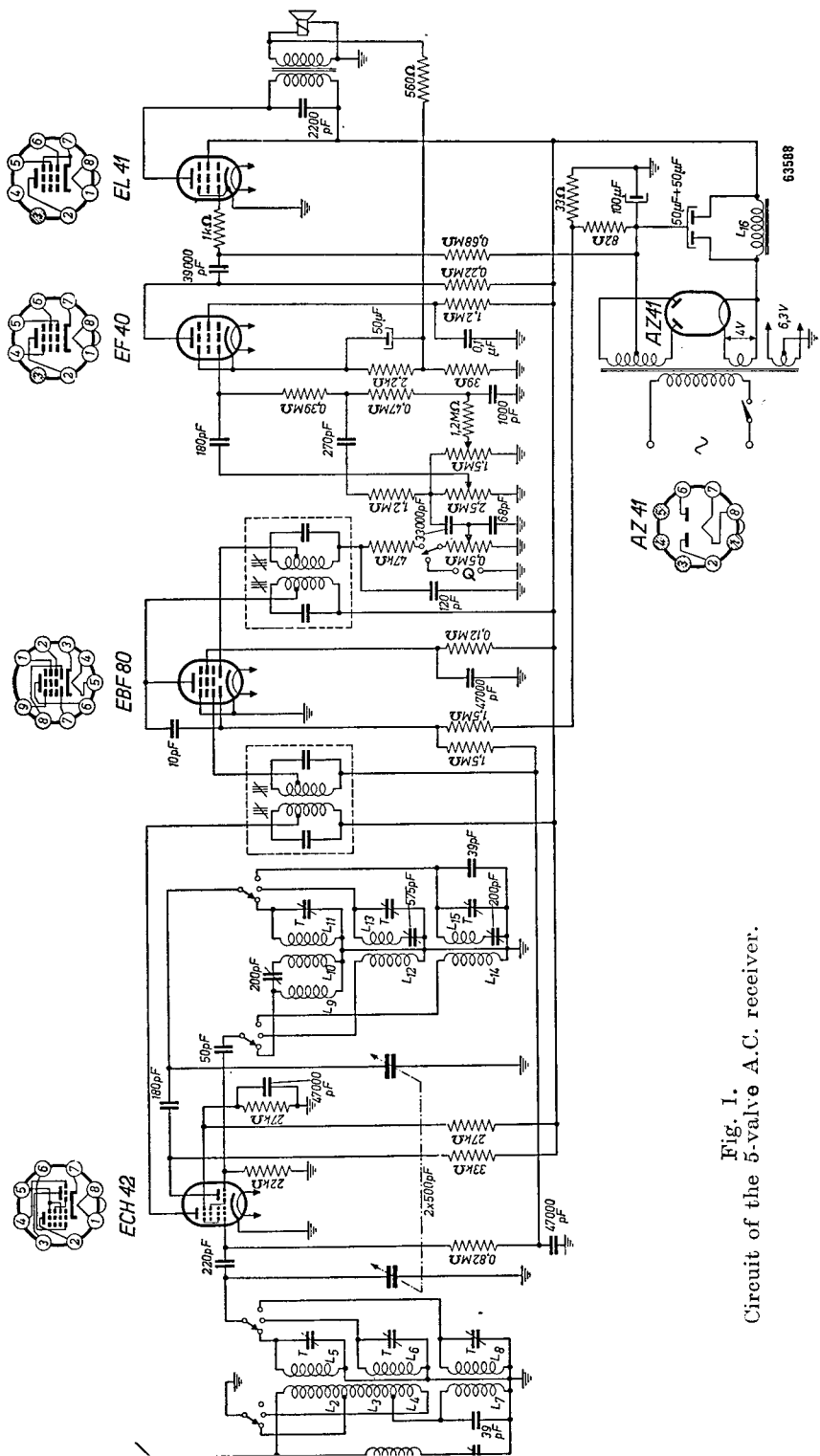

Fig. 1. Circuit of the 5-valve A.C. receiver.

Sensitivity, measured with an output power of 50 mW and a signal modulated at 400 c/s to a depth of 30%.

At the control grid of the EL 41	430 mV _{RMS}
At the control grid of the EF 40	33 mV _{RMS}
At the gramophone pick-up sockets	80 mV _{RMS}
At the control grid of the EBF 80	3.2 mV _{RMS}
At the control grid of the ECH 42 (at 1 Mc/s)	40 μV _{RMS}
At the aerial (at 1 Mc/s)	8.5 μV _{RMS}

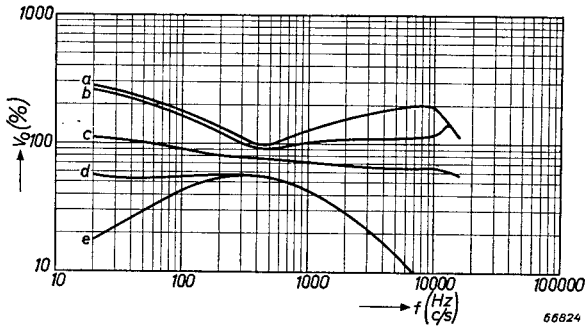

Fig. 2. Frequency response of the A.F. section, for various settings of the tone control (see also Fig. 3 of the description of Circuit VI.)

XVI. A 4-valve A.C./D.C. superheterodyne receiver

Description

This 4-valve circuit is very similar to the one described in Section VIII, which employs the UAF 42 instead of the UBF 80. For a complete description of the circuit, reference may be made to Section III. The fact that the UBF 80 has two diodes gives this valve a distinct advantage over the UAF 42.

Moreover, the contact potential of these diodes is subject to less variation than that of the third grid of the UAF 42, when used as a diode; as the internal resistance is also lower than that of the third grid, the general performance of the circuit will be more constant. For the rest, the delay voltage for the A.G.C. is obtained in the same way as in Circuit VIII, only using the UBF 80. To suppress hum, a hum-bucking coil is incorporated in the output transformer; for a description of this device see Section I

MEASURED VALUES

Voltages and currents

Valve	Anode voltage (V)	Screen grid voltage (V)	Grid bias (V)	Anode current (mA)	Screen grid current (mA)
UCH 42					
Hexode	160	70	-1.9	2.2	2.4
Triode	78	—	—	4.8	—
UBF 80	160	70	-1.9	4	1.5
UL 41	175	160	-9.5	50	9.5

Sensitivity, measured with an output power of 50 mW, using a signal with 30% modulation at 400 c/s.

At the control grid of the UL 41	0.52 V_{RMS}
At the control grid of the UBF 80	11 mV_{RMS}
At the control grid of the UCH 42	100 μV_{RMS}
At the aerial (at 1 Mc/s)	50 μV_{RMS}

XVII. A 9-valve A.M./F.M. receiver for A.C. mains

Introduction

In this circuit separate mixing and I.F. amplification channels are employed for A.M. and F.M. reception. Although this requires two more valves than when the channels are combined, it brings with it many advantages, such as simpler construction, greater sensitivity, cheaper wavelength switch, etc., which more than outweigh the cost of the extra valves. From the block diagrams of the circuit shown in Figs. 1*a* and *b*, it will be seen that the diodes of the EBF 80, EQ 80, EL 41, EM 34 and EZ 40 are used jointly for both F.M. and A.M. reception.

The sensitivity of this receiver is 6-10 μV for A.M. reception with a standard output power of 50 mW, and approx. 25 μV for F.M. reception with a voltage of 8 V_{RMS} on grids 3 and 5 of the F.M. detector EQ 80.

Three wave-bands are provided for A.M. reception, the F.M. frequency range being 88—108 Mc/s. The F.M. section is designed for a frequency swing of 2×75 kc/s.

F.M. reception

The F.M. section employs the following valves (see Figs. 1*a* and 2) :

- EF 42 — self-oscillating frequency changer,
- EF 42 — first I.F. valve,
- EF 42 — second I.F. valve,
- EQ 80 — detector and amplitude limiter,
- EL 41 — output amplifying valve,
- EBF 80 — A.G.C. diode and auxiliary diode for silent tuning,
- EM 34 — tuning indicator and amplifier for silent tuning,
- EZ 40 — rectifying valve.

The mixing stage

The aerial signal is applied to the central tapping of the oscillator coil L_3 , through an inductive coupling L_1 - L_2 matched with 75 ohms. Coil L_3 forms part of the oscillator circuit of the frequency changer EF 42, of which the cathode, control grid and screen grid constitute a Colpitts oscillator. When the capacitance of the screen grid with respect to earth is equal to that of the control grid, also with respect to earth (this being obtained by adjusting the trimmer C_9), the oscillator voltage on the central tapping of L_3 , i.e. in the aerial circuit, is reduced to a minimum (see page 342).

In order to reduce the input damping of the EF 42, a capacitor C_{10} of about 22 pF is included in the cathode circuit, whilst a self-inductance of 1 μH in parallel with this capacitor allows the direct current to flow. This self-inductance must not be too large, otherwise sufficient feedback to be noticeable will occur at the intermediate frequency.

So-called "split-stator" capacitors, which are subject to very little parasitic self-inductance, are recommended for the tuning capacitors C_3 - C_6 . The frequency range of the oscillator circuit is 93.7 - 120.7 Mc/s, that of the R.F. circuit 83 - 110 Mc/s. In view of the high frequencies involved, all leads in the R.F. and mixing stages should be kept as short as possible. With a signal frequency of 100 Mc/s, the conversion gain of the mixing stage (central tapping of oscillator coil to control grid of the second EF 42) is approximately 24.

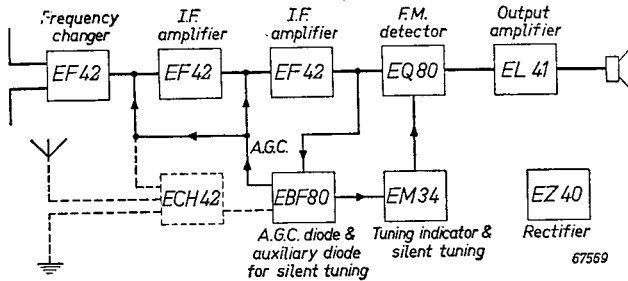

Fig. 1a. Block diagram of the F.M. section.

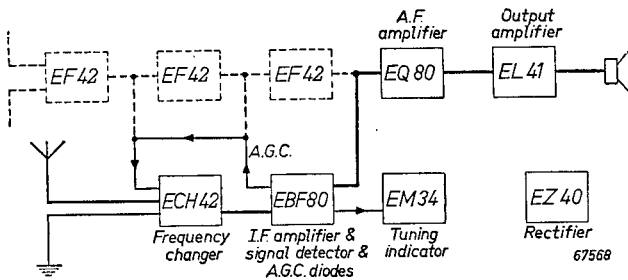

Fig. 1b. Block diagram of the A.M. section.

The I.F. section

The I.F. transformers are tuned to an intermediate frequency of 10.7 Mc/s. The I.F. amplifier comprises two EF 42 pentodes, coupled by means of an I.F. transformer. In order to ensure a minimum of distortion, the frequency-response curve of the I.F. section should have a flat peak and, from the viewpoint of selectivity, steep flanks. The flat peak is essential to avoid excessive amplitude modulation due to the frequency modulation, whilst steep flanks ensure a high selectivity. In order to secure a suitable frequency response, coupling between primary and secondary of each I.F. transformer exceeds the critical value ($KQ=1.4$).

For an overall bandwidth of 225 kc/s (0 dB attenuation for a maximum frequency swing of 75 kc/s), a circuit with a quality factor, Q , of 66 is required. The values of the inductance and capacitance are such that maximum gain is obtained without risk of instability due to the grid-to-anode capaci-

tance of the valve ; the inductance is approx. 5.4 μH , and the capacitance, comprising parasitic capacitance + extra capacitance, is about 40 pF. Since the quality factor of the coils is higher than 66 (for details of the coils see Fig. 4), the design includes extra damping resistors of 56 k Ω in parallel with them; the total impedance of the I.F. transformer is then 10 - 11 k Ω . The slope of the EF 42 is 9.5 mA/V, so that a maximum I.F. amplification of about 100 is obtained.

The I.F. amplifier and the detector EQ 80 (for details and description see page 413) are coupled by means of the last I.F. transformer.

F.M. detector

The anode current of the EQ 80 is almost a linear function of the difference in phase between the voltages on the third and fifth grids of the valve, provided that each voltage is at least 8 V_{RMS} . The average anode current is then independent of the amplitude of the alternating grid voltages, so that the valve functions as an amplitude limiter.

Before the I.F. signal can be rectified, the frequency modulation must be transformed into phase modulation of the alternating voltages on grids 3 and 5. This is effected by the last I.F. transformer, the voltages of which are automatically 90° out of phase at the tuning frequency. This difference in phase varies with the frequency; any variation in the frequency thus automatically results in a variation in phase displacement.

The circuits of the last I.F. transformer are coupled inductively to a coil in the anode circuit of the last EF 42. It can be shown that the phase variation $\Delta\varphi$ between the voltages across these circuits is in accordance with the following :

$$\tan \Delta\varphi = \frac{2 \Delta f Q_s}{f_0},$$

where

- Δf = frequency variation,
- f_0 = tuning frequency,
- Q_s = quality factor of the second tuned circuit.

This shows that the variation in phase is not a linear function of the frequency; however, if this variation is sufficiently small, distortion can never be very pronounced ; with a maximum variation of $\pm 30^\circ$ in the phase, the distortion is approximately 2.5%, which may be considered admissible. Using the above formula on the basis of a maximum frequency swing of 75 kc/s and an intermediate frequency of 10.7 Mc/s, it will be found that the quality factor of the second tuned circuit should be 41. As the quality factor of the actual circuit was in excess of this, an extra damping resistor is required to obtain the indicated Q of 41. Under normal working conditions the quality factor of the first tuned circuit ($L_{10}-C_{21}-C_{22}$) is between 65 and 70.

The choice of the coupling factor for these two circuits takes into account the fact that, if this factor were below the critical value, the voltage across the second circuit would be lower than that across the first and, moreover,

would not be sufficiently independent of the varying frequency. If too tight a coupling is employed, the tuning curve will be too humped, giving rise to distortion. Experiments proved that the most satisfactory coupling occurs with a KQ of 1.2 to 1.3.

Apart from the necessary inductive coupling, parasitic capacitive coupling also exists between the circuits; the capacitance of grid 3 with respect to grid 5, for instance, is 0.35 pF, and care should therefore be taken that extra capacitive coupling does not exceed 1/4 of the total amount of coupling. The tuning curve might otherwise diverge too much when a defective EQ 80 is replaced. For this reason a minimum of 50 pF is specified for the tuning capacitors in each of the circuits, which means that the inductance should be 4.45 μ H. The coupling between the circuit $L_{10} - C_{21} - C_{22}$ and the coupling coil L_9 is roughly 1 : 1, the mutual inductance being approximately equal to the self-inductance of L_{10} .

Tuning indication and silent tuning

Fig. 3, which represents the anode current of the EQ 80 as a function of the frequency, shows that this current varies by 80 μ A for a frequency swing of 75 kc/s. The correct tuning frequency is 10.7 Mc/s, but it is also possible to obtain the same volume when the set is tuned to a frequency occurring on one of the flanks of the curve, say to 10.4 Mc/s, although distortion is then of course much more pronounced.

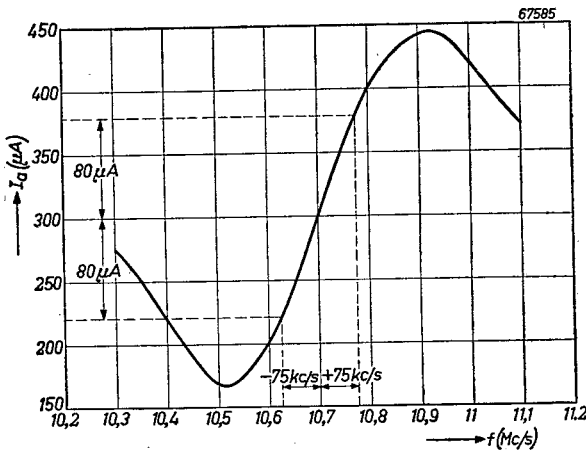

Fig. 3

Anode current of the EQ 80 as a function of the I.F. signal frequency, measured under static conditions with 8 V_{RMS} on grids 3 and 5, and silent tuning inoperative.

these cannot be used for the tuning indicator, for which reason an extra circuit, comprising $L_{12} - C_{26}$, is coupled to the lower end of the primary of the last I.F. transformer by means of a capacitor C_{27} .

L_{13} is a R.F. coil providing a path for the direct current from grid 5 to earth. The capacitor C_{28} is added to short-circuit the long leads to the switch at the intermediate frequency (switch S_1 connects grids 3 and 5 of the EQ 80 to

to obtain the same volume when the set is tuned to a frequency occurring on one of the flanks of the curve, say to 10.4 Mc/s, although distortion is then of course much more pronounced. Silent tuning, as a result of which the receiver is mute until tuned to the correct frequency, is employed to remove every possibility of incorrect tuning.

The tuning indicator EM 34 operates on the direct voltage obtained from rectification of the I.F. signal. Since the curves representing the selectivity of the I.F. transformers are very flat-topped, the voltages on

grids 2, 4 and 6 when the valve is used as the A.F. amplifier for A.M. reception). The I.F. signal, which reaches its maximum value at a frequency of 10.7 Mc/s, is applied to the diode of the EBF 80 through C_{25} and switch S_{11} . Since the positive voltage on the cathode of the EBF 80 is about 6 V, a peak signal voltage of 8 V produces a direct voltage of about 2 V for driving the tuning indicator EM 34.

Now, as a peak signal voltage of 8 V across C_{26} corresponds to a voltage of $8 V_{RMS}$ on grids 3 and 5 of the EQ 80, the tuning indicator does not operate until the voltage on grids 3 and 5 has risen sufficiently.

The EM 34 is also employed for the purposes of silent tuning. When the set is tuned and the grid of the EM 34 is negative, the voltage drop across the anode resistor R_{43} is reduced and the anode of the triode system becomes more positive. In the absence of a signal voltage, i.e. when the grid of the EM 34 is at zero potential, the voltage on the anode (that is, at the junction of R_{42} and R_{43}) is 35 V with respect to earth. At the junction of R_{41} and R_{42} this positive voltage is balanced out by the negative voltage of approx. 6.3 V across C_{65} (R_{45} and C_{65} are used merely for de-coupling).

The first grid of the EQ 80 is connected, through the switch S_{12} , to the junction of R_{41} and R_{42} . In the absence of a signal, the potential of this first grid, with respect to earth, is zero, but, since the cathode of this valve carries a voltage of +4 V with respect to earth, the first grid is still negative with respect to the cathode, to the extent of 4 V, and the valve is practically biased to cut-off.

Immediately a signal voltage of resonant frequency comes through, a negative control voltage is applied to the EM 34, the first grid of the EQ 80 becomes less negative, and the valve comes into operation. The resistors R_{41} and R_{42} are so chosen that the voltage on the first grid of the EQ 80 is prevented by the grid current from exceeding the cathode voltage.

A.G.C.

When signals from very strong stations are received, sufficient voltage might possibly be generated in the detector to bring the EQ 80 into operation even when the receiver is detuned. For this reason, A.G.C. is applied to the I.F. valves, the signal being taken from L_{10} to the second diode of the EBF 80, through C_{20} and switch S_9 . The anode of this diode is biased to approximately 12 V with respect to the cathode, which is at a positive potential (6 V) with respect to earth. The voltage divider, consisting of the resistors R_{35} , R_{31} and R_{30} , is so arranged that the negative voltage at the junction of R_{35} and R_{31} is 6 V with respect to earth, the bias voltage for the I.F. valves being taken from the junction of R_{30} and R_{31} . With a bias of 12 V on the A.G.C. diode, the gain control should come into operation when the I.F. voltage on the anode reaches approx. $8.5 V_{RMS}$, but as C_{20} is only 22 pF, the required voltage across L_{10} and on the control grids of the EQ 80 will be approx. $10 V_{RMS}$.

As indicated in Fig. 3, a frequency variation of 75 kc/s produces a variation in the anode current of the EQ 80 of about 80 μ A. The amplitude of this anode current, multiplied by the anode impedance, represents the output

voltage of the EQ 80. For F.M. reception, the anode impedance consists of the resistors R_{19} and R_{21} in parallel, their total resistance being $0.4 \text{ M}\Omega$. With a frequency swing of 75 kc/s , the peak output voltage is 32 V , or 22.7 V_{RMS} , which is more than sufficient to drive the output stage.

The output stage

The output valve is the EL 41, which is capable of delivering an output of 4 W . The cathode of this pentode is connected to the "top" of the secondary side of the output transformer, thus providing feedback to a factor of approximately 2.5. The anode resistor R_{19} of the EQ 80 is bypassed by 150 pF (C_{31}), and this combination of R_{19} and C_{31} functions as a de-emphasis filter, the values of these components being such as will give a time constant of $75 \text{ }\mu\text{sec}$. A simple tone control for cutting the highest frequencies as desired is provided by the combination $C_{33} - R_{23} - R_{24}$ in parallel with the output transformer. Control of the volume, for F.M. reception, is effected by means of the potentiometer R_{21} .

A.M. reception

A block diagram of the A.M. section is shown in Fig. 1b. When the set is used for A.M. reception, the valves EF 42 are inoperative, although the power supply to the third of these is maintained in order to avoid an excessive increase in the H.T. voltage. When the switches S_1 to S_{13} are turned up one position, the receiver is set for short-wave reception; the next two positions are for the medium and long waves.

The mixing stage, incorporating the valve ECH 42, corresponds to that described in Section I, page 123. When the set is switched for F.M. reception, the supply voltage to this valve is cut off by switch S_{13} ; this ensures that the oscillator will not give rise to interference in the F.M. section. The pentode section of the EBF 80 is used for I.F. amplification, and the I.F. signal (452 kc/s) delivered by the last I.F. transformer is applied to a diode of the EBF 80 through switch S_{11} , the direct voltage component being taken, via R_{37} , to the control grid of the EM 34 tuning indicator.

The A.F. signal is taken from potentiometer R_{39} , via C_{63} and switch S_{12} , to the first grid of the EQ 80, which now functions as the A.F. amplifier. In the A.M. circuit, the switch S_1 connects grids 3 and 5 to grids 2, 4 and 6. In view of the fact that the full A.F. amplification of the EQ 80 is not necessary for A.M. reception (this being even impracticable from the point of view of microphony), the anode impedance is reduced by means of a $56 \text{ k}\Omega$ resistor, R_{20} , connected in parallel with R_{19} , this having the effect of reducing the A.F. amplification to 20.

As the potentiometer R_{39} is used for volume control when the receiver is set for A.M. reception, R_{21} is then rendered inoperative by the switch S_3 .

The potentiometers R_{39} and R_{21} can be mounted on a common spindle, that a single control knob will serve for both A.M. and F.M. reception.

MEASURED VALUES

Sensitivity: F.M. reception

The following values were obtained with a voltage of $8 V_{RMS}$ on grids 3 and 5 of the EQ 80, and a frequency swing of ± 75 kc/s :

At the control grid of the second I.F. amplifier EF 42	150 mV_{RMS}
At the control grid of the first I.F. amplifier EF 42	1.5 mV_{RMS}
At the central tapping of L_3	62 μV_{RMS}
At the aerial	23 μV_{RMS}

Sensitivity: A.M. reception

(output 50 mW, modulation depth 30%)

At the control grid of the EL 41	1 V_{RMS}
At the first grid of the EQ 80	55 mV_{RMS}
At the control grid of the EBF 80	2.1 mV_{RMS}
At the control grid of the ECH 42	30 μV_{RMS}
At the aerial	6-10 μV_{RMS}

Voltages and currents

F.M. reception (without signal)

Valve	Anode voltage (V)	Screen grid voltage (V)	Cathode voltage (V)	Grid bias (V)	Anode current (mA)	Screen grid current (mA)
EF 42 - frequency changer	240	200	—	—	7.5	1.6
EF 42 - first I.F. valve	235	235	—	-2.3	7	1.8
EF 42 - second I.F. valve	235	235	—	-2.3	7	1.8
EQ 80 - detector	250	32	+4.1	+0.75	—	—
EL 41 - output valve	235	250	—	-7.5	32	4
EBF 80	250	105	+6.3	-2.3	—	—
EM 34 - tuning indicator	35-30	250	—	-0.8	—	—

A.M. reception (without signal)

Valve	Anode voltage (V)	Screen grid voltage (V)	Cathode voltage (V)	Grid bias (V)	Anode current (mA)	Screen grid current (mA)
ECH 42 - hexode	250	85	—	-1.8	2.6	3.5
triode	140	—	—	—	3.5	—
EBF 80 - I.F. valve	250	87	—	-1.8	5.5	2
EQ 80 - A.F. valve	235	26.5	3.9	—	0.3	—
EL 41 - output valve	235	250	—	-7	36	5
EM 34 - tuning indicator	35-30	250	—	-0.8	—	—

Coils

- $L_1 - L_2$ L_1 consists of 1.5 turns of 1.5 mm enamelled copper wire wound between the $1\frac{3}{4}$ turns of L_2 , on a bobbin 7 mm in diameter. Length of coil 7 mm.
- L_3 Consists of $1\frac{3}{4}$ turns of 1.5 mm enamelled copper wire with central tapping, wound on a 7 mm bobbin; length of coil 7 mm.
- L_4 Consists of 18 turns of 0.2 mm enamelled copper wire wound on a bobbin 4.5 mm in diameter; length of coil 7 mm. This coil may also be wound on a carbon resistor the resistance value of which is over 20 k Ω .
- $L_5 - L_6$ See Fig. 4: $L_5 = L_6 = 4.5 \mu\text{H}$ without core and approx. 5 μH with core.
Each coil consists of 35 turns of 0.3 mm enamelled copper wire, wound on a bobbin with a core, type 7978. The diameter of the can is 30 mm, the height 60 mm. At 10.7 Mc/s, without extra damping, $KQ=2$.
- $L_7 - L_8$ Identical with $L_5 - L_6$.
- $L_9 - L_{10} - L_{11}$ See Fig. 5. L_{10} and L_{11} consist of 20 turns of 0.55 mm enamelled copper wire, close-wound on a 14 mm bobbin. L_9 consists of 20 turns of 0.3 mm enamelled copper wire, wound over L_{10} at the earthed end. An insulating layer 0.1 mm thick must be inserted between L_9 and L_{10} . At 10.7 Mc/s, without extra damping, the coupling factor KQ between L_{10} and L_{11} is 1.3; the quality factor Q of each coil is 68 at 10 Mc/s. The diameter of the can is 30 mm, the height 60 mm.
- L_{12} 45 turns of 1 mm enamelled copper wire, close-wound on a bobbin 14 mm in diameter. The coil is 55 mm long. Self-inductance: 6.2 μH , $Q=125$. The diameter of the can is 30 mm, the height 60 mm.

- L_{13} R.F. choke with a self-inductance of 1 mH.
 L_{14} Tuned to intermediate frequency (452 kc/s) by means of C_{35} .
 $L_{15} - L_{27}$ Dependent on wave-bands required.
 $L_{28} - L_{29}$ Philips I.F. transformer, type 5730.
 $L_{30} - L_{31}$ Philips I.F. transformer, type 5730.
 L_{32} Smoothing choke : 8 H - 115 mA.
 T_1 Output transformer for a primary impedance of 7000 ohms.
 T_2 Power transformer.
 Secondary : 2×270 V - 100 mA.
 Heater winding : 6.3 V - 3.3 A.

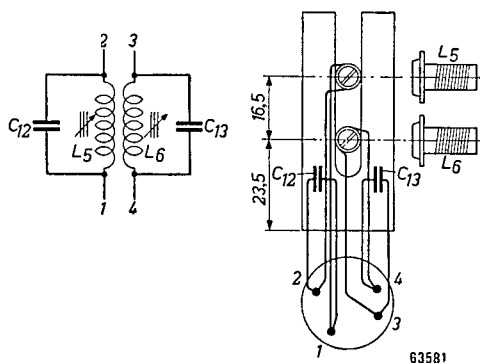

Fig. 4

Circuit and sketch of the I.F. transformers $L_5 - L_6$ and $L_7 - L_8$ of the F.M. section.

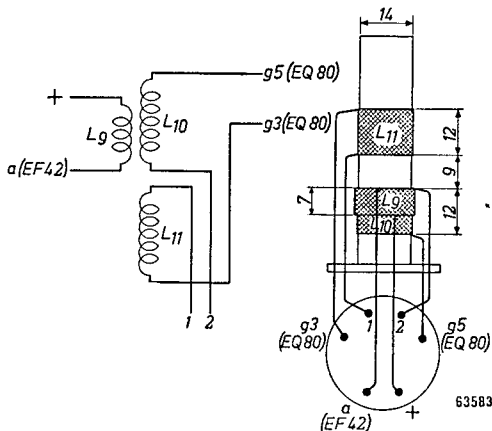

Fig. 5

Circuit and sketch of the I.F. transformer $L_9 - L_{10} - L_{11}$ preceding the EQ 80 in the F.M. section.

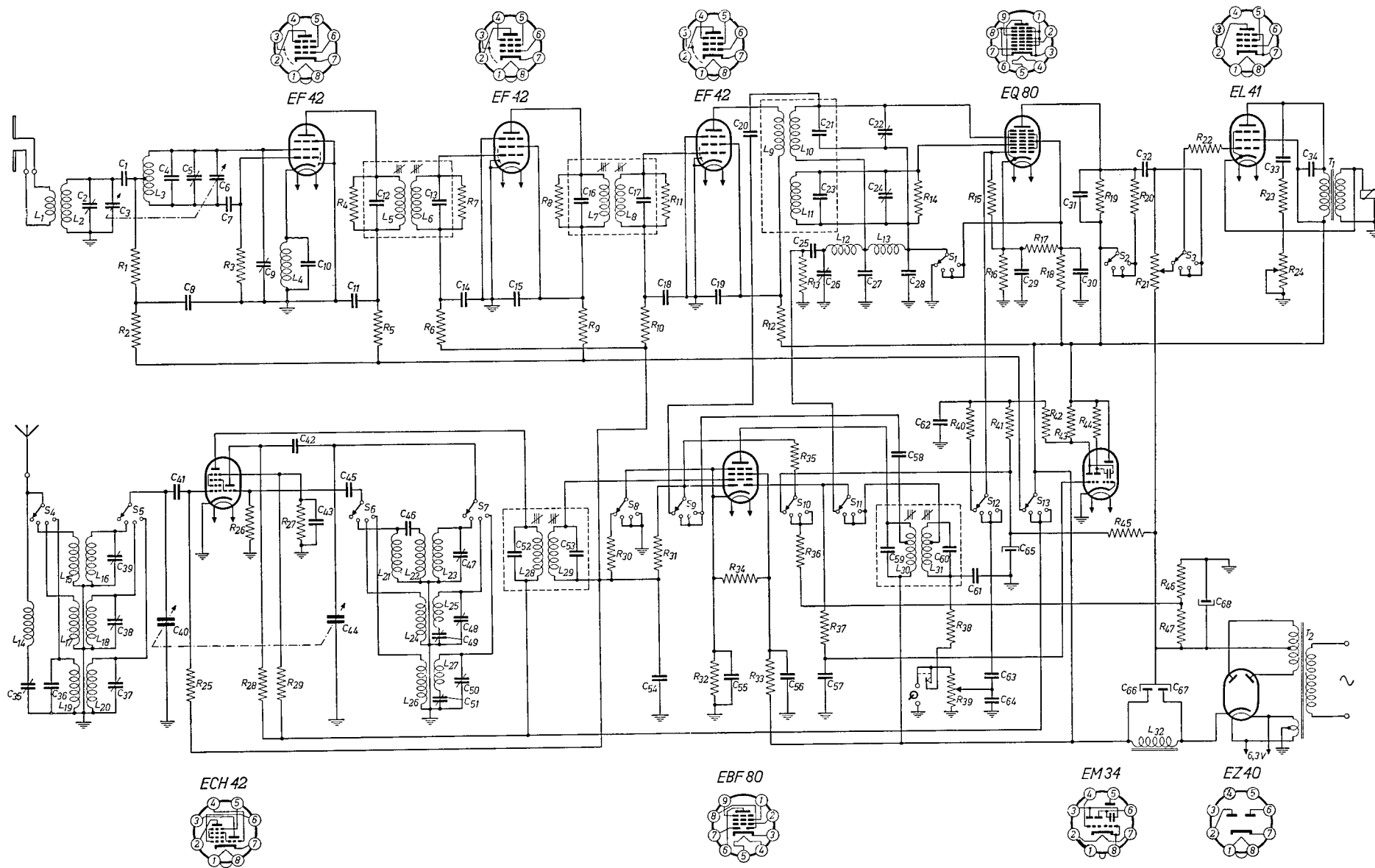

Fig. 2. A combined A.M./F.M. receiver. The resistor R_{10} is superfluous and should be short-circuited.

Resistors

R_1	=	27 k Ω	0.5 W
R_2	=	4.7 k Ω	0.25 W
R_3	=	0.22 M Ω	0.25 W
R_4	=	56 k Ω	0.25 W
R_5	=	1.5 k Ω	0.25 W
R_6	=	0.22 M Ω	0.25 W
R_7	=	56 k Ω	0.25 W
R_8	=	56 k Ω	0.25 W
R_9	=	1.5 k Ω	0.25 W
R_{10}	=	0.22 M Ω	0.25 W
R_{11}	=	56 k Ω	0.25 W
R_{12}	=	1.5 k Ω	0.25 W
R_{13}	=	0.82 M Ω	0.25 W
R_{14}	=	22 k Ω	0.25 W
R_{15}	=	10 M Ω	1 W
R_{16}	=	600 Ω	0.25 W
R_{17}	=	3.9 k Ω	0.25 W
R_{18}	=	2×68 k Ω (parallel)	2×1 W
R_{19}	=	0.68 M Ω	0.25 W
R_{20}	=	56 k Ω	0.25 W
R_{21}	=	1 M Ω (log.potentiometer)	
R_{22}	=	1 k Ω	0.25 W
R_{23}	=	100 Ω	1 W
R_{24}	=	20 k Ω (lin.potentiometer)	
R_{25}	=	0.82 M Ω	0.25 W
R_{26}	=	27 k Ω	0.25 W
R_{27}	=	27 k Ω	0.5 W
R_{28}	=	33 k Ω	0.5 W
R_{29}	=	27 k Ω	1 W
R_{30}	=	2.7 M Ω	0.5 W
R_{31}	=	1.2 M Ω	0.25 W
R_{32}	=	820 Ω	0.25 W
R_{33}	=	$39 + 47$ k Ω (parallel)	2×1 W
R_{34}	=	15 k Ω	1 W
R_{35}	=	0.1 M Ω	0.5 W
R_{36}	=	0.82 M Ω	0.25 W
R_{37}	=	0.82 M Ω	0.25 W
R_{38}	=	56 k Ω	0.25 W
R_{39}	=	0.5 M Ω (log.potentiometer)	
R_{41}	=	56 k Ω	0.25 W
R_{42}	=	0.27 M Ω	0.25 W
R_{43}	=	0.18 M Ω	0.25 W
R_{44}	=	1 M Ω	0.25 W
R_{45}	=	10 k Ω	0.25 W
R_{46}	=	22 Ω	0.5 W
R_{47}	=	56 Ω	1 W

Capacitors

C_1	=	180 pF
C_2	=	3-30 pF (trimmer)
C_3 - C_6	=	3-23 pF (2-gang, split-stator)
C_4	=	33 pF
C_5	=	3-30 pF (trimmer)
C_7	=	68 pF
C_8	=	3300 pF
C_9	=	3-30 pF (trimmer)

C_{10}	=	22 pF
C_{11}	=	3300 pF
C_{12}	=	39 pF
C_{13}	=	27 pF
C_{14}	=	3300 pF
C_{15}	=	3300 pF
C_{16}	=	39 pF
C_{17}	=	27 pF
C_{18}	=	3300 pF
C_{19}	=	3300 pF
C_{20}	=	22 pF
C_{21}	=	15 pF
C_{22}	=	3-30 pF (trimmer)
C_{23}	=	27 pF
C_{24}	=	3-30 pF (trimmer)
C_{25}	=	47 pF
C_{26}	=	3-30 pF (trimmer)
C_{27}	=	5600 pF
C_{28}	=	47,000 pF
C_{29}	=	47,000 pF
C_{30}	=	47,000 pF
C_{31}	=	150 pF
C_{32}	=	4700 pF
C_{33}	=	18,000 pF
C_{34}	=	1000 pF
C_{35}	=	3-30 pF (trimmer)
C_{36}	=	37 pF
C_{37}	=	3-30 pF (trimmer)
C_{38}	=	3-30 pF (trimmer)
C_{39}	=	3-30 pF (trimmer)
C_{40-44}	=	11-500 pF (2-gang tuning capacitor)
C_{41}	=	220 pF
C_{42}	=	220 pF
C_{43}	=	47,000 pF
C_{45}	=	47 pF
C_{46}	=	180 pF
C_{47}	=	3-30 pF (trimmer)
C_{48}	=	3-30 pF (trimmer)
C_{49}	=	350 pF
C_{50}	=	3-30 pF (trimmer)
C_{51}	=	200 pF
C_{52}	=	115 pF
C_{53}	=	115 pF
C_{54}	=	0.1 μ F
C_{55}	=	47,000 pF
C_{56}	=	47,000 pF
C_{57}	=	0.1 μ F
C_{58}	=	10 pF
C_{59}	=	115 pF
C_{60}	=	115 pF
C_{61}	=	68 pF
C_{62}	=	1 μ F
C_{63}	=	18,000 pF
C_{64}	=	56 pF
C_{65}	=	100 μ F - 12.5 V
C_{66-67}	=	2×50 μ F - 355 V
C_{68}	=	100 μ F - 12.5 V

**LATEST PHILIPS
MEASURING AND
AUXILIARY EQUIPMENT**

**FOR
LABORATORIES, TEST-ROOMS AND WORKSHOPS**

**SUPPLEMENT TO INFORMATION SUPPLIED
IN VOLUMES II AND III**

Cathode-ray oscilloscope GM 5653

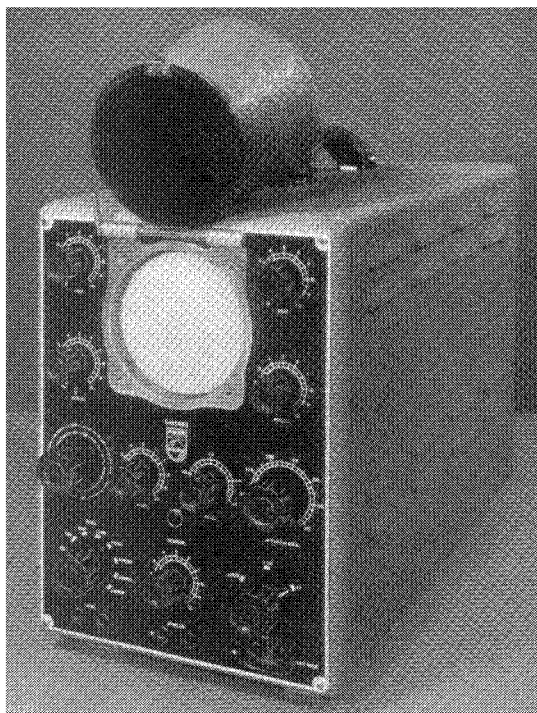

The GM 5653 is a general-purpose oscilloscope for use in laboratories and, as an aid to production, in workshops, factories, etc. It is also suitable for pulse techniques.

The cathode-ray tube DG 10-6 gives a sharply defined, bright trace; a contrast-intensifying screen in front of the tube makes it possible to use the instrument in daylight.

The amplifier, input attenuator and input itself will satisfy the very high requirements imposed on an oscilloscope in modern pulse techniques.

This instrument is also suitable for use in connection with television and for reproducing and photographing transient phenomena. It has a built-in post-acceleration voltage of $1200 + 400$ V, ensuring an extra clear image. A test prod having a very high input impedance (10 megohms) and low input

capacitance is supplied with the unit.

The input impedance and input capacitance of the oscilloscope are the same in all positions of the attenuator, viz. 1 megohm and max. 15 pF respectively. Moreover, the input impedance is independent of the frequency. The input is formed by a cathode follower. The frequency characteristic is such as will ensure undistorted amplification of the pulses.

TECHNICAL DATA

Amplifier

Four high- μ pentodes, giving a gain of 700

Frequency

- 1 c/s—3 Mc/s; 90%—100% full gain
- 5 Mc/s; 45% full gain
- 7 Mc/s; 30% full gain

Sensitivity

At maximum amplification, over $15 \text{ mV}_{RMS}/\text{cm}$

Attenuation

In stages 1 : 1, 1 : 10, 1 : 100

Continuous max. 1 : 11

Test prod 1 : 20

Maximum input voltage

- 1) Direct : 14 V_{RMS}
- 2) With test prod : 280 V_{RMS}

Input impedance

- 1) Direct : 1 megohm and $< 15 \text{ pF}$
- 2) With test prod : 10 megohms and $< 8 \text{ pF}$
- 3) With test prod, unattenuated : 0.5 megohm and $< 70 \text{ pF}$

Beam modulation

- Input voltage : 2 V_{RMS}
- Input resistance : 0.1 megohm

Direct plate connection

- Vertical : $7 \text{ V}_{RMS}/\text{cm}$ ($20 \text{ Vdc}/\text{cm}$)
- Horizontal : $8.5 \text{ V}_{RMS}/\text{cm}$ ($24 \text{ Vdc}/\text{cm}$)

Time base frequency

5 c/s—160 kc/s at full amplitude, up to 200 kc/s with approx. 6 cm amplitude

Valves

Amplifiers : $3 \times \text{EF 42}$ and $2 \times \text{EL 41}$

Time base : $3 \times \text{EF 42}$ and $1 \times \text{UF 42}$

Power unit : $4 \times \text{AZ 41}$, $1 \times \text{UL 41}$, $1 \times \text{EF 42}$ and $2 \times \text{85 A1}$

Cathode-ray tube : DG 10-6

Anode voltage 1200 V

Post-acceleration voltage 1200 + 400 V

Power supply

110, 125, 145, 200, 220, 245 V; 40—100 ...

Power rating : 130 VA (approx. 110 W)

1.6 A fuses in both sides

Synchronization

Pos.	Time base	Synchronization
1	Int.	Vert. ampl.
2	Int.	Ext. 5 megohms
3	Ext.	Valve No. 4 delivers 0.3 V_{RMS} /cm at 7000 ohms
4	Single sweep	Make or break contact for 10 V D.C.
5	Int.	50 c/s
6	Ext.	50 c/s, 3 V_{RMS} from Valve No. 4 at 100 ohms

Dimensions and weight

31.5 × 25 × 46.5 cm ; approx. 26 kg

Signal tracer GM 7628

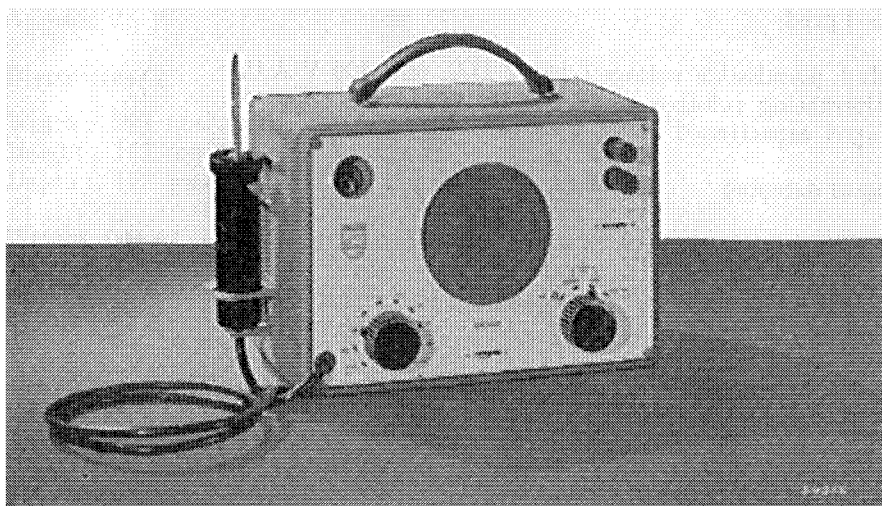

With the aid of this instrument it is possible to trace quickly faults in receivers and R.F. or A.F. amplifiers. The sensitivity and gain of each stage in a receiver or amplifier can be determined, the measurement being approximate but easily reproduced.

A.G.C. and oscillator voltages are traced by means of the electronic indicator, whilst, in conjunction with an oscillator, the 400 c/s modulation signal can be detected by ear, using the built-in loudspeaker. It is also possible to

switch off the speaker and use the electronic indicator alone. A selector switch enables any one of the following to be used as indicating instrument:

- a. the built-in electronic indicator and loudspeaker (the latter can be switched off);
- b. a valve voltmeter;
- c. a universal measuring unit, e.g. the GM 4257;
- d. a cathode-ray oscilloscope.

Two special terminals are provided for connection to any one of the instruments mentioned in b, c and d above.

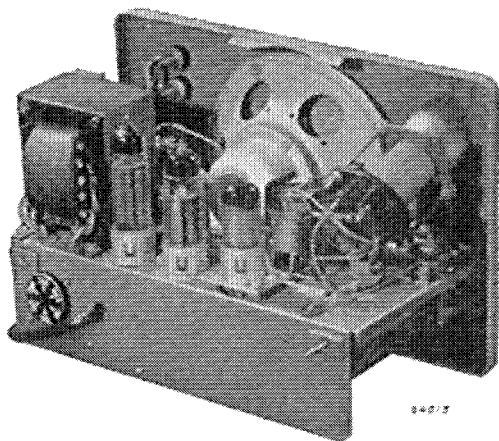

Internal view of the Signal Tracer. Note the Rimlock valves and the oblique position of the electronic indicator.

TECHNICAL DATA

Test prod

Max. permissible voltage : 250 V D.C. plus 100 V A.C.
Alternating voltages up to 100 Mc/s
Input capacitance approx. 10 pF

Input damping

In "A.G.C." position with open output terminals : approx. 12 M Ω
In "A.F." position : > 1 M Ω
In "OSC" and "H.F." positions : 0.2 M Ω at 1.5 Mc/s

Sensitivity

A R.F. signal modulated with 400 c/s to a depth of 30% gives full deflection of the electronic indicator at approx. 100 mV, half deflection at approx. 50 mV and a slight, but still perceptible, deflection at about 15 mV.
On an A.F. signal of 400 c/s, full deflection is obtained at approx. 100 mV, half deflection at about 20 mV and a still perceptible deflection at 1 mV.
In the "OSC" position, a R.F. voltage of approx. 18 V gives full deflection of the indicator (1 V gives a just perceptible deflection).
In the "A.G.C." position, a direct voltage of about 18 V completely closes the EM 4 (1 V giving perceptible deflection).

Input attenuator

Eight positions : attenuation factors 1 to 150
Calibrated for a R.F. signal modulated to a depth of 30% with 400 c/s, and for an A.F. signal of 400 c/s
Accuracy of attenuator : approx. 15%

Output impedance

Position "Indicator" : >1.5 M Ω
Position "Osc. gr." : approx. 15,000 Ω
Two extra positions for extreme loads of 10,000 Ω and 2.5 Ω
Maximum power output : 0.9 W at 1000 c/s, with 10% distortion

Valves

EA 50 (1 \times), EF 41 (1 \times), EL 41 (1 \times), EM 4 (1 \times), AZ 41 (1 \times)

Power supply

Universal transformer with tapping plate for 110, 125, 145, 200, 220 and 245 V (40 - 100 c/s)

Consumption

Approx. 26 W

Dimensions

Width : 297 mm (including control knobs and brackets)

Height : 187 mm

Depth : 152 mm

Weight

5.05 kg

Finish

The instrument is housed in a light-grey steel case with a leather carrying-handle.

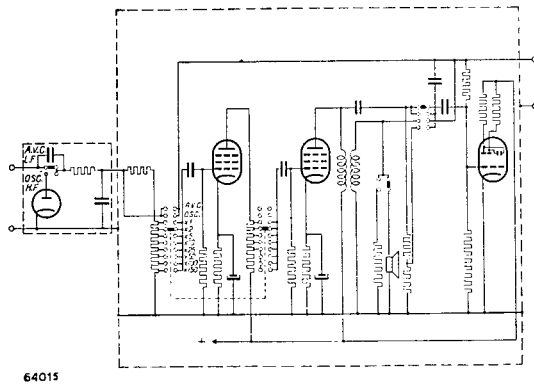

Skeleton circuit.

RC-oscillator GM 2315

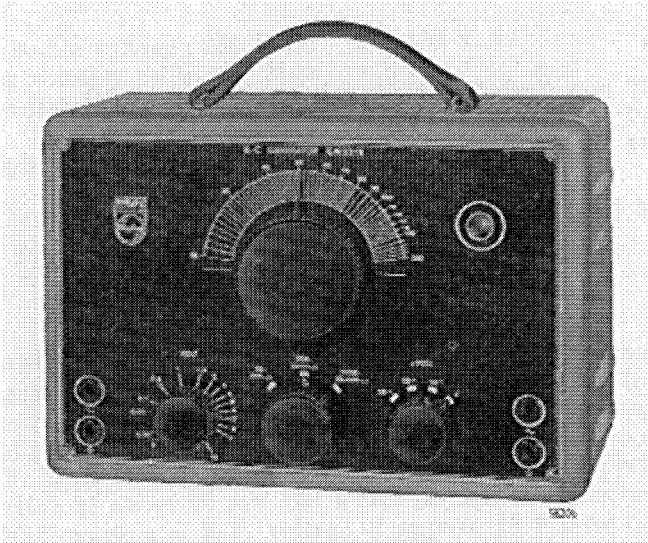

This oscillator, which uses a resistance-capacitance circuit, is intended for servicing purposes, for testing A.F. amplifiers and for supplying external modulation for R.F. oscillators. The frequency band extends from 20 to 20,000 c/s, and is divided into three ranges. The change-over from one range to another is effected by means of a special selector switch which brings different resistors into the R-C network. *The same two variable, mechanically coupled capacitors are used at all frequencies.* The tuning knob is mounted on the common spindle of these capacitors.

When the range switch is rotated, contact to the appropriate resistors, mounted on the selector switch, is established by fixed contact springs. The switch itself is so constructed that effective contact and high insulation resistance are ensured.

The frequency generated is determined by the values of the capacitors and resistors in the R-C network, in accordance with the following:

$$f = \frac{1}{2\pi\sqrt{R_1 R_2 C_1 C_2}} \text{ c/s } (C_1 = C_2).$$

The output voltage is variable between 0.5 mV and 10 V by means of a stepped attenuator and a continuously variable output control. A fixed mains lead is provided, and the mains switch is coupled with the continuous output control.

A pilot lamp lights to indicate when the instrument is switched on.

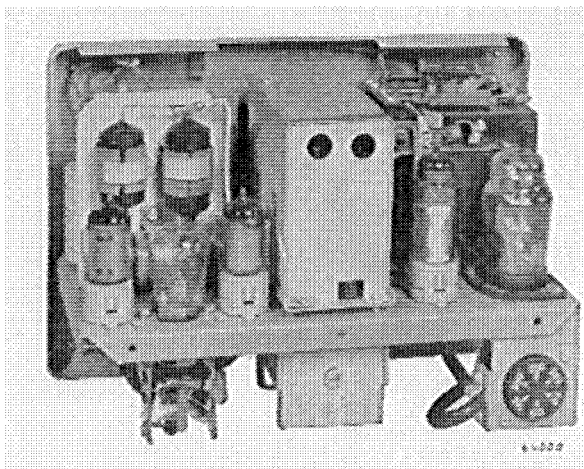

Interior view of the GM 2315.

TECHNICAL DATA

Frequency range

20—20,000 c/s, divided as follows :
20— 200 c/s
200— 2000 c/s
2000—20,000 c/s

Frequency accuracy

When the instrument has reached its working temperature the frequency error is less than 5%, the scale error being less than 2%.

Frequency stability

The frequency variation resulting from mains voltage fluctuations of 5% is less than 0.1%. The frequency drift, after 10 minutes warming-up, is less than 1%.

Output voltage

Variable between 0.5 mV and 10 V by means of a stepped attenuator with positions for 0.001—0.01—0.1—1, and a continuously variable output control (0—10). The accuracy of the attenuator is roughly 10%.

Max. output impedance : 7000 ohms.

The variation in output voltage resulting from mains voltage fluctuations of 5% is less than 1%.

Variation of output voltage with frequency

Between 20 and 200 c/s: less than 20%
Between 200 and 2000 c/s: less than 5%
Between 2000 and 20,000 c/s: less than 10%

Distortion

Between 35 and 20,000 c/s: $<1\%$

Hum voltage

$< 0.5\%$. At frequencies close to the mains frequency, or multiples thereof, possibly 3—5%.

Valves

EF 41 (2 \times), EL 41, EZ 2, 0300 BA 15, 8034 D-00

Power supply

Universal transformer with tapping plate for 110, 125, 145, 200, 220 and 245 V (50—100 c/s)

Consumption : approx. 30 W

Dimensions

Width : 25 cm

Height : 18 cm

Depth : 14 cm (including control knobs)

Weight : 5.2 kg

Finish

The instrument is housed in a light-grey steel case with a leather carrying handle.

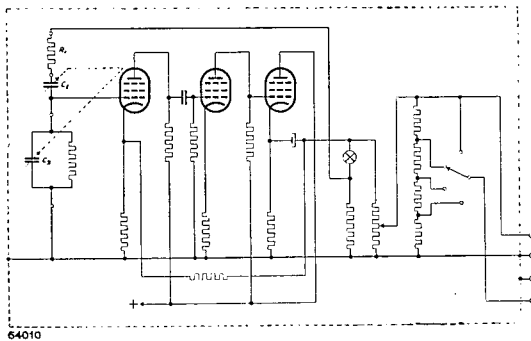

Skeleton circuit.

D.C. power supply unit with stabilized output voltage type GM 4560/01

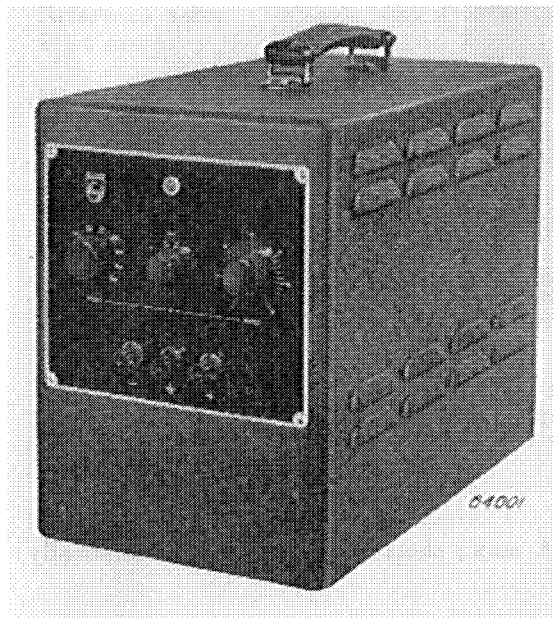

The unit GM 4560/01 delivers a constant voltage such as is particularly essential for accurate measurements (D.C. test amplifiers etc.), for plotting valve characteristics, and for the calibration of measuring instruments, etc.

FEATURES

1. Output voltage continuously variable between 145 and 310 V
 2. Practically independent of load
 3. Insensitive to mains voltage fluctuations
 4. Low internal resistance
 5. Automatic limitation of short-circuit current
6. Very low ripple voltage, independent of load
 7. Output voltage independent of mains frequency variations between 40 and 100 c/s

DESCRIPTION

The D.C. voltage is filtered and is then taken to the output terminals by way of two pentodes connected in parallel. As the terminal voltage depends on the internal resistance of these pentodes, it is possible, by suitably controlling these series valves, to eliminate the effects of mains voltage fluctuations and variations in load, thus ensuring a constant output voltage. The reference voltage for the control system is derived from a voltage source with a voltage reference valve, from which no current is taken.

TECHNICAL DATA

Output voltage

Voltage variable between 145 and 310 V in 10 stages of 15 V each, and continuously variable within a range of 30 V by means of a separate control knob.

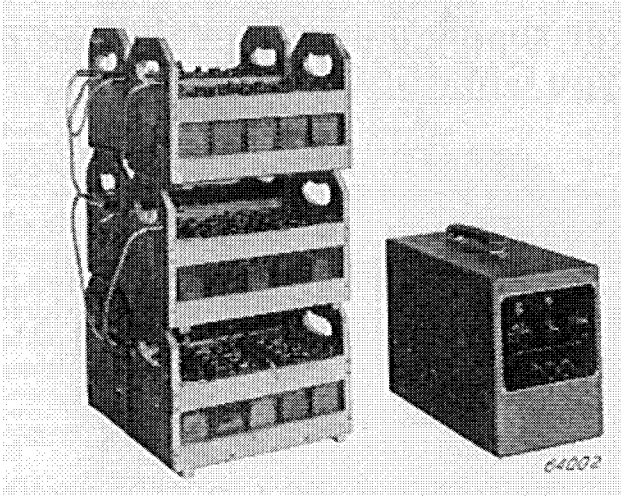

The GM 4560/01 compared with a battery of accumulators supplying equivalent power at the same voltage.

Current

Continuous load up to 100 mA max.; short-circuit current automatically limited to 400 mA.

Voltage stabilization

Variation in voltage due to mains voltage fluctuations of $\pm 5\%$: 150 mV
 Variation in voltage due to variations in the load : 0.1 V with variations in current from 0 up to full load (100 mA).

Internal resistance

At 300 V with a current < 30 mA: 4 ohms
 with a current > 30 mA: 1 ohm
 At 150 V with a current < 30 mA: 3 ohms
 with a current > 30 mA: 1 ohm

Ripple voltage

0.001% of the output voltage, independent of the load

Power supply

All-mains supply ; no batteries required. Universal transformer with tapping plate for 6 voltages : 110/125/145/200/220/245 V, 40—100 c/s.
 Consumption : approx. 85 W under no-load conditions, approx. 140 W at full load (100 mA).

Valves

Full-wave rectifying valve	AX 50
Pentodes	4699 (2×) and EF 6
Reference valve	85 A 1
Pilot lamp	8045 D/00

Weight and dimensions

Length 40 cm	Height 31 cm
Width 23 cm	Weight approx. 18 kg

Modulated R.F. oscillator GM 2883

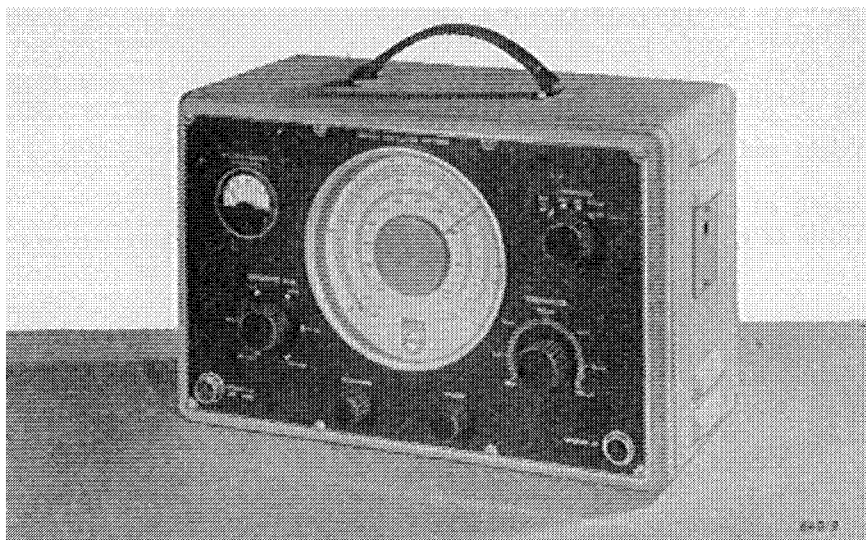

DESCRIPTION

The GM 2883 is a modulated R.F. oscillator with a wide frequency range (100 kc/s to 30 Mc/s); it delivers a constant frequency, free from interference. The instrument contains a variable master oscillator, an A.F. oscillator and a R.F. amplifying stage. The A.F. oscillator generates fixed frequencies of 400 and 2500 c/s and modulates the R.F. signal to a depth of 30%. The modulated R.F. signal is applied via a calibrated attenuator to a high-frequency cable connected to a dummy aerial.

The A.F. voltage is brought out to a separate terminal, so that it can be used externally, the voltage on this terminal being controlled by a potentiometer. A built-in output meter is used to measure either the modulated R.F. voltage across the attenuator input or the voltage on the A.F. output terminal. It is also possible to modulate the R.F. signal with an external modulation voltage.

FEATURES

Built-in output meter capable of measuring R.F. as well as A.F. voltages
Separate I.F. range from 400—500 kc/s with an accuracy of 1 kc/s. Two internal modulation frequencies: 400 and 2500 c/s.

Facility for external modulation.

Large dial.

Frequency modulation negligible.

A built-in amplifier is provided for external modulation, so that only a low modulation voltage is required.

The built-in meter can be used for the following purposes :

- a. to adjust the R.F. voltage,
- b. to adjust the A.F. voltage,
- c. as output meter, for trimming receivers.

TECHNICAL DATA

Frequency ranges

- | | |
|------------------|-----------------|
| 1. 100— 300 kc/s | 4. 3— 10 Mc/s |
| 2. 300—1000 kc/s | 5. 10— 30 Mc/s |
| 3. 1— 3 Mc/s | 6. 400—500 kc/s |

These ranges overlap at both ends.

Accuracy of the frequency

Ranges 1—5: error $<1\%$

Range 6: error ± 1 kc/s

Frequency stability

Variation due to mains voltage fluctuations of 10% : $<0.02\%$

Variation due to temperature variations of 10°C : $<0.1\%$

OUTPUT VOLTAGE

R.F.

Continuously variable between 1 and 100 mV by means of a calibrated attenuator. The voltage on the attenuator is adjustable by means of a control knob and is measured by the output meter. The attenuator scale is semi-logarithmic, with 50 divisions.

Accuracy : better than 1 division at frequencies under 3 Mc/s.

A.F.

The A.F. voltage, 400 or 2500 c/s, is intended for internal modulation, but can be tapped off for external application.

Modulation

By built-in oscillator : 400 or 2500 c/s, as required, modulation depth 30% .

By external voltage source: 30—10,000 c/s, modulation depth 0— 80% . An A.F. voltage of approx. 0.4 V is required for a modulation depth of 30% .

Output meter

Accuracy, when used as R.F. output meter : better than 5% at nominal mains voltage.

For measurement of the output of a receiver, the impedance between the speaker terminals should be less than 1000 ohms.

Valves

3 × EF 41, 2 × EF 50 N, AZ 41, 150 A1

Power supply

Universal transformer with voltage tapping plate for 110, 125, 145, 200, 220 and 245 V, 40—100 c/s

Consumption : approximately 23 W

Dimensions

33.5 × 22 × 16.5 cm

Weight approx. 8 kg

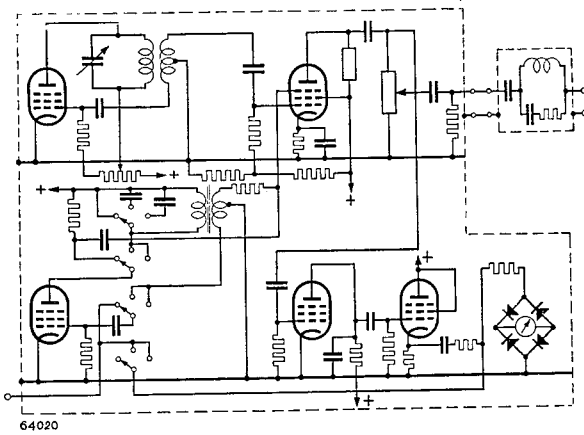

Skeleton circuit of the modulated R.F. oscillator GM 2883.

Universal measuring apparatus GM 4257

This instrument measures

**voltage,
current,
resistance and
capacitance**

with sufficient accuracy for all practical purposes. A meter with a large dial for easy reading even at a distance, and four scales covering all measuring ranges, is supplied with the unit. Pilot lamps indicate from which scale the reading is to be taken.

A separate built-in transformer is provided to feed the apparatus on test, so that :

1. the current consumed can be measured,
2. the apparatus on test is switched off automatically whilst its resistances and capacitances are measured,
3. the apparatus on test is not connected directly to the mains; hence the chassis of A.C./D.C. receivers can be earthed.

Switches have been substituted by a 5-pole plug. A separate measuring range is provided for the detection of leakage.

Universal transformer for the power supply.

Variations in the mains voltage can be corrected.

The meter is an entirely separate unit.

Test leads, mains flex and connecting cable are supplied with the instrument.

TECHNICAL DATA

The instrument comprises 9 separate units, viz.

1. Power unit with mains voltage correction

This unit contains a transformer and rectifier to supply the voltage required for resistance and capacitance measurements. A voltage tapping plate

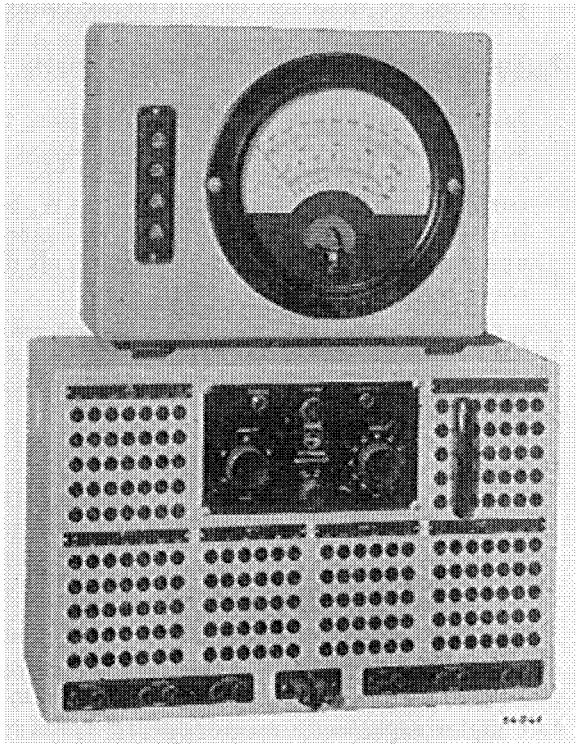

enables the transformer to be adapted to mains voltages of 110, 125, 145, 200, 220 and 245 V, frequency 50 c/s. Coarse and fine adjustments are provided for the correction of mains voltage variations.

2. Transformer with output sockets to supply the apparatus on test

Like the transformer in the power section, this can also be adapted to any local mains voltage. The secondary supplies 100, 125, 145, 200, 220 or 245 V to the output terminals of the instrument. The continuous output rating of this transformer is 100 W, but a temporary load of 150 W is not harmful. The transformer is so connected that the supply to the apparatus on test is automatically cut off during measurement of resistances and capacitances.

3. Unit for resistance measurements

Measuring ranges :

0.5	—	100 ohms
5	—	1000 ohms
50	—	10,000 ohms
500	—	100,000 ohms
0.005	—	1 megohm
0.05	—	10 megohms
0.25	—	50 megohms

Accuracy: Between 1 and 20 scale divisions the error is within 10% of the value indicated.

4. Unit for capacitance measurements

Measuring ranges :

500	—	20,000 pF
5000	—	200,000 pF
0.05	—	2 μ F
0.5	—	20 μ F
5	—	200 μ F

Accuracy: Up to 5 scale divisions the error is <15%, and above that <10% of the value indicated. The unit can also be used for mains voltage calibration and for the detection of leakages, the latter being indicated by a pilot lamp.

5. Unit for measuring direct voltages

Measuring ranges: Full-scale readings, 1, 2, 5, 20, 50, 200 and 500 V.
Accuracy: Error <5% of full-scale deflection.

Meter loading: 10,000 Ω/V ; for the highest range: 5000 Ω/V .

The instrument is protected against overloads up to a factor of about 100, except in the range up to 1 V.

6. Unit for measuring alternating voltages

Measuring ranges: Full-scale readings, 2, 5, 20, 50, 200 and 500 V.

Accuracy: Error $< 5\%$ of full-scale deflection.

Meter loading: For the 50, 200 and 500 V ranges: $1000 \Omega/V$; for the other ranges: $50 \Omega/V$.

7. Unit for measuring alternating currents

Measuring ranges: Full-scale readings, 50, 200, 500 and 2000 mA.

Accuracy: Error $< 5\%$ of full-scale deflection.

Voltage drop between terminals: 0.06 V up to 50 mA, negligible in the other ranges.

This unit also has two other measuring ranges, viz. one up to 500 mA, the other up to 2000 mA, for measuring the current supplied by the special built-in transformer to the apparatus on test.

8. Unit for measuring direct currents

Measuring ranges: Full-scale readings, 2, 5, 20, 50, 200, 500 and 2000 mA.

Accuracy: Error $< 5\%$ of full-scale deflection.

Voltage drop across the terminals: 1 V at full-scale deflection.

9. Meter unit

This contains a $100 \mu A$ moving coil instrument. The dial comprises two linear scales (0—500 and 0—200) and two separate scales for resistance and capacitance. Four pilot lamps fitted alongside the dial indicate from which scale the reading is to be taken.

Further features

The frequency range for the measurement of alternating voltages and currents is 50 to 6000 c/s, $\pm 10\%$, although the error may be slightly greater in the 2 V and 2000 mA ranges.

Weight and dimensions

Main unit

Width: 44 cm

Height: 30 cm

Depth: 22 cm

Weight: approx. 14.5 kg

Meter

Dial: 187 mm diameter

Width: 34 cm

Height: 26 cm

Depth: 12.5 cm

Weight: approx. 6.5 kg

R.F. service oscillator GM 2884

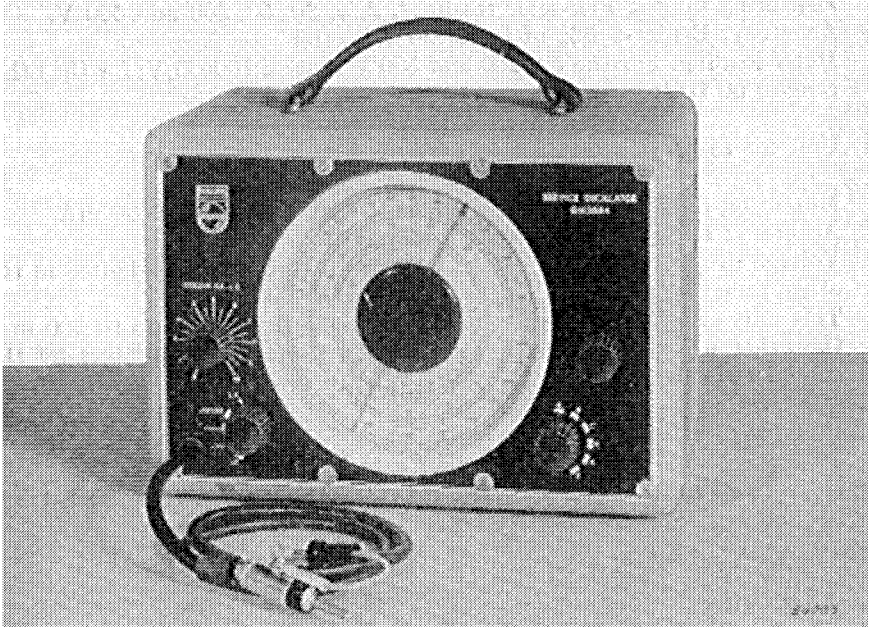

This simple R.F. oscillator was designed especially for use in trimming and testing radio receivers.

DESCRIPTION

The instrument contains an oscillatory circuit which, by switching the self-inductance and associated coupling coil, enables a frequency to be produced which is variable between 100 kc/s and 25 Mc/s in 6 stages. For each of these six ranges a scale is provided on the dial, the diameter of which is 125 mm.

The R.F. voltage is applied to the receiver on test through a low-capacitance screened cable to which a dummy aerial can be connected. This voltage can be varied between 0 and approx. 100 mV, by means of a stepped attenuator and a continuously variable volume control coupled to the mains switch. The R.F. signal is modulated to a depth of about 30% with the aid of a built-in 400 c/s oscillator. When the stepped attenuator is set to a special position, an A.F. signal only (variable between 0 and 5V) is applied to the output cable; this signal can be used for the testing of A.F. amplifiers.

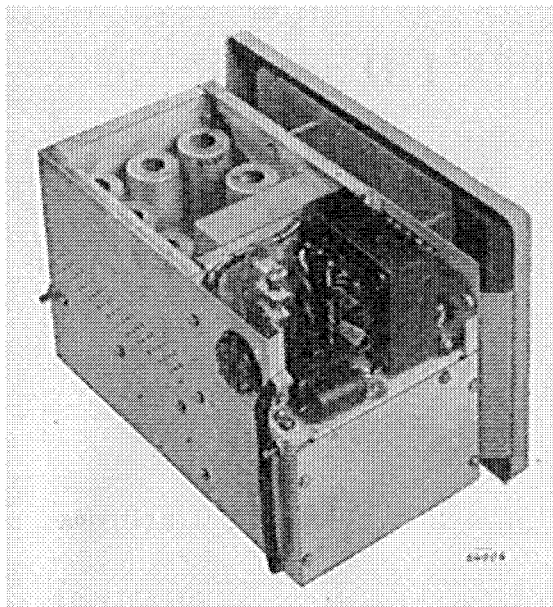

Photograph of the interior of the GM 2884.
(A screening plate has been removed.)

TECHNICAL DATA

Frequency ranges

A.	100	kc/s—250	kc/s
B.	250	kc/s—600	kc/s
C.	600	kc/s— 1.5	Mc/s
D.	1.5	Mc/s— 4	Mc/s
E.	4	Mc/s— 10	Mc/s
F.	10	Mc/s— 25	Mc/s

All ranges overlap at both ends.

Accuracy of the frequency

After the instrument has reached working temperature:
 $\pm 1\%$.

Frequency stability

Variation in frequency due to mains voltage fluctuations of 10%: not more than 0.2%.
Variations in the load have no effect on the frequency.

R.F. output voltage

This is variable between 0 and approx. 100 mV by means of a stepped attenuator (positions $\times 1$, $\times 20$, $\times 500$, $\times 10,000$) and a continuously variable volume control.

Up to 2 Mc/s the attenuator is accurate to within approx. 15%. The output is unbalanced, one of the output terminals being earthed.

Modulation

The R.F. signal is modulated to a depth of about 30%, with 400 c/s $\pm 20\%$. When the attenuator is set to the fifth position, the A.F. signal is applied to the output cable; this signal can be varied between 0 and 5 V ($\pm 20\%$) by means of the volume control.

Distortion: $< 10\%$.

Valves

ECH 21 (2 \times), EZ 2 (1 \times)

Power supply

Universal transformer with rotary tapping plate for 110-125-145-200-220-245 V (40-100 c/s).

Consumption

Approx. 16 W

Dimensions

Length 25 cm

Width 19 cm (including control knobs)

Height 18 cm

Weight

Approx. 5.5 kg

Finish

The instrument is housed in a light-grey steel case with a leather carrying-handle.

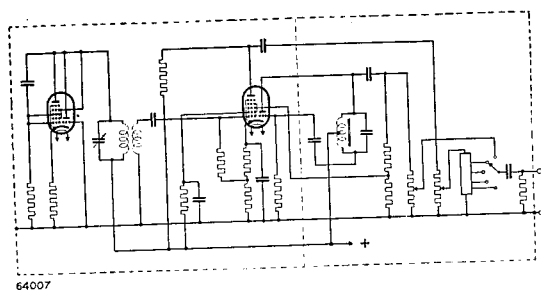

Skeleton circuit of the GM 2884.

A.F. generator GM 2307

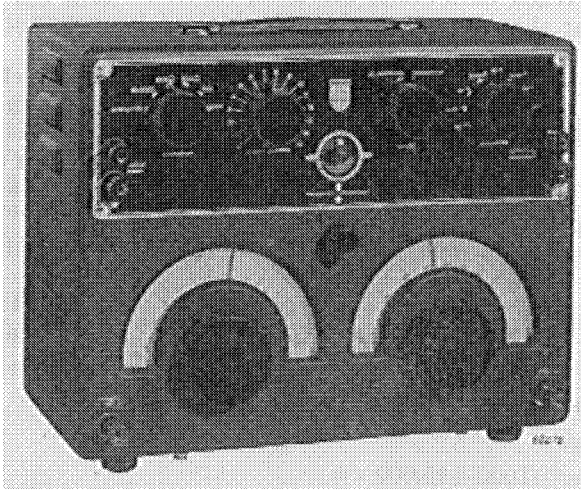

APPLICATION

This A.F. generator will deliver an alternating voltage the frequency of which can be varied within the range of audibility. It was developed particularly with a view to its possible uses in the field of acoustics.

FEATURES

1. Wide frequency range (30-16 000 c/s).
2. Separate dial for the lower frequencies.
3. Highly accurate scales.
4. Practically no distortion.
5. Highly stable frequency.
6. High output voltage, practically constant throughout the entire frequency range.
7. Built-in 9-stage attenuator (10 dB per stage)
8. Output voltage balanced or unbalanced as required; this choice is also available when the attenuator is used.
9. Output can be adapted to 4 different load impedances.
10. Low hum voltage.
11. Almost insensitive to mains voltage fluctuations.
12. Accurate zero adjustment with the aid of an electronic indicator.
13. The amplifier can be used separately.

DESCRIPTION

The test frequency is generated by mixing the signals from two R.F. oscillators of variable frequency. The low frequency beat thus obtained is amplified and is taken to the output terminals. Two control knobs, with scales of

30—1000 c/s and 1000—15,000 c/s respectively, are used for adjustment of the frequency. When both scales are used, the value indicated on the one is added to that shown on the other; the highest frequency obtainable is therefore 16 000 c/s.

The output signal can be taken either from the built-in matching switch, or from the calibrated attenuator. Under normal conditions the maximum output voltage is 15 V, but when the output switch is set to a special position, a voltage of up to 50 V is made available. The voltages in both these ranges are continuously variable, and can be increased, by means of an additional screwdriver adjustment, up to 32 V and 100 V respectively.

Subject to certain conditions, a direct reading of the voltage can be obtained from the scale on the control knob.

By means of a separate switch, the output can be rendered either balanced or unbalanced with respect to earth, the voltage being practically the same in each case.

TECHNICAL DATA

Frequency range

Left-hand scale: 1000—15,000 c/s

Right-hand scale: 30— 1000 c/s

Combined scales: 30—16,000 c/s

Accuracy of scales

Between 200 and 16,000 c/s: $\pm 1\%$

Between 30 and 200 c/s: max. 2 c/s

Stability of the frequency

Frequency drift due to mains voltage fluctuations of 10%: $< 2\%$

Frequency drift 10 minutes after switching on (warming up period): < 20 c/s during the first three hours; after that the variation is negligible

Output

The output switch has six positions, viz.

1. calibrated attenuator:
load impedance
> 25,000 ohms

2. matching 1000 ohms

3. matching 500 ohms

4. matching 250 ohms

5. matching 5 ohms

6. output voltage 50 V (100 V): load impedance > 100,000 ohms

In positions 1-5 the output can be rendered balanced or unbalanced with respect to earth, as required, by means of a special switch.

Output voltage

With 1000 ohms matching, or with attenuator in operation: max. 15 V (32 V), indicated on the scale on the control knob (error $< 5\%$)

With switch in position 6: max. 50 V (100 V)

Possible error over the entire frequency range: $< 2.5\%$

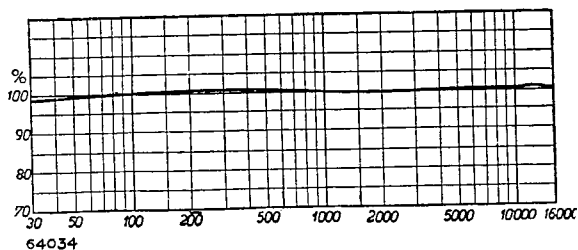

Output power

Standard : 225 mW

Variable : 100 mW—0.8 W

Attenuator

Nine stages (10 dB per stage); max. attenuation 10,000 : 1

Possible error : < 1% of the nominal value

Construction

The instrument is housed in a light-grey steel case with a leather handle; dials and control knobs are conveniently arranged.

Distortion

Frequency	Distortion (%) at		
	100 mW	225 mW	0,8 W
30 c/s	<2 %	<2.5%	<3.5 %
100 c/s	<1 %	<1.5%	<2 %
5000 c/s and higher	<0.25%	<0.3%	<0.75%

Hum voltage

At an output voltage of 15 V: < 1%.

A.F. amplifier

Two input terminals at the rear of the unit linked directly to the amplifier; when these terminals are used, the R.F. oscillators can be switched off.

Power supply

The unit is operated from A.C. mains and is fitted with a tapping plate covering six voltages, viz. 110/125/145/200/220/245 V, 40—100 c/s.

Consumption : approx. 40 W.

Valves

Triode-hexode	ECH 21
Pentode	EF 6
A.F. pentode-indicator	EFM 1
Double diode-pentode	EBL 21
Rectifying valve	EZ 2
Neon stabilizer	150 A 1

Dimensions and weight

Height 25.5 cm

Width 34 cm

Depth 20 cm (including control knobs)

Weight approx. 12 kg

Electronic volt - ohm - mA meter GM 7635

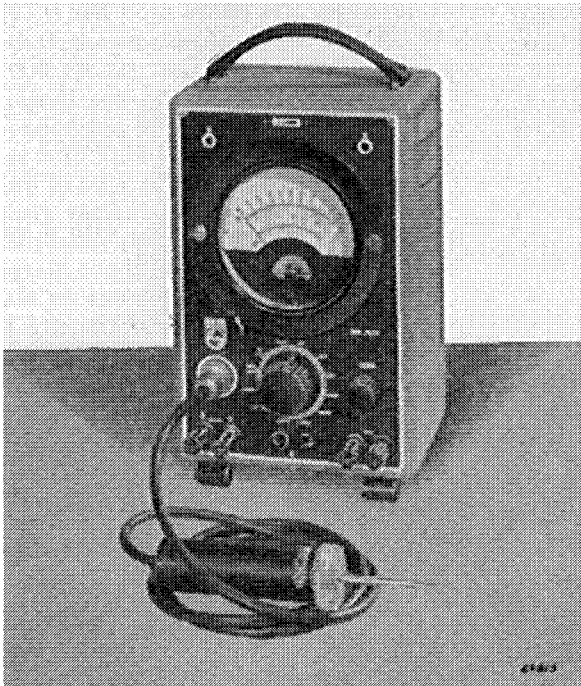

The GM 7635, with interchangeable test prod and an illuminated dial.

This instrument was designed for measuring line voltages, currents and resistances. It is capable of measuring direct voltages up to 1000 V (up to 30,000 V with special test probe GM 4579), alternating voltages up to 300 V in the frequency range 50 c/s to 100 Mc/s, direct current up to 300 mA, and resistances up to 10 M Ω . The interchangeable test prod, fitted with an A.C./D.C. switch, is suitable for measuring all voltages except the 1000 V, D.C. range. Separate connections are provided for the measurement of direct current, resistance, and the 1000 V D.C. range. In the last-mentioned instance, the pin of the test prod is inserted in one of the sockets marked mA, the test-range switch is rotated to the 100 V setting, and the switch on the test prod to the D.C. (— — —) position.

A change-over switch is provided to co-ordinate the meter deflection with the polarity of the direct current or direct voltage to be measured. A selenium cell is employed to prevent overloading ; the supply voltages are stabilized. Adjustable are :

- a. the zero point (electrical and mechanical),
- b. the sensitivity,
- c. the test voltage for the resistance range,
- d. the built-in arrangement for checking the attenuator.

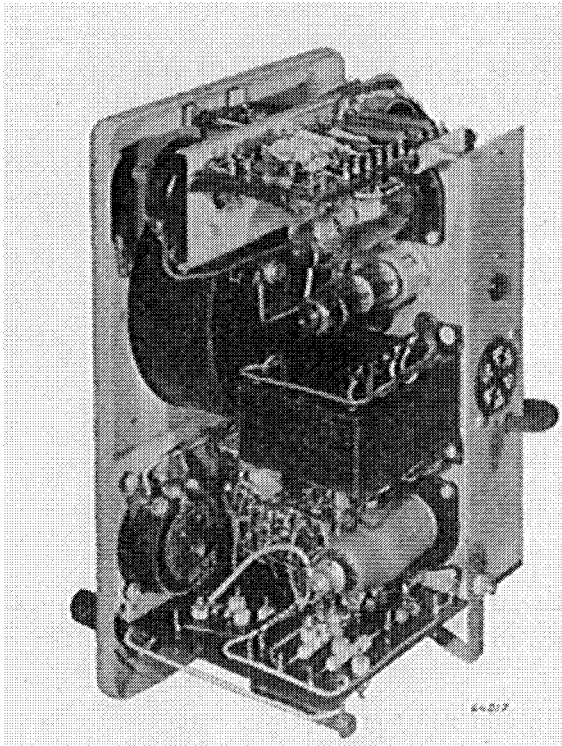

Interior view of the GM 7635.

TECHNICAL DATA

Test ranges

Direct voltage : 0-3, 10, 30, 100, 300, 1000 V

Alternating voltage : 0-3, 10, 30, 100, 300 V

Direct current : 0-3, 30, 300 mA

Resistance : 0-1000 Ω , 10,000 Ω , 100,000 Ω , 10 M Ω

Frequency range

50 c/s - 100 Mc/s.

Input damping

On D.C. ($\overline{- - -}$):	approx.	9	M Ω
On A.C. (\sim):	„	3	M Ω at 1000 c/s
	„	1.5	M Ω at 1 Mc/s
	„	0.1	M Ω at 15 Mc/s
	„	0.04	M Ω at 40 Mc/s

Input capacitance

On A.C. (\sim): approx. 9.5 pF (at test prod)

Accuracy

Alternating voltage : error $< 5\%$ ($50\text{ c/s} - 50\text{ Mc/s}$)

Direct voltage : error $< 5\%$

Alternating current : error $< 3.5\%$

Resistance : error $< 5\%$

Influence of the mains voltage

A mains voltage fluctuation of 5% results in an additional error as follows:

VOLT : $\pm 3.5\%$ without, or $\leq 1\%$ with zero correction.

OHM : $\pm 4\%$ without, or $\leq 2\%$ with zero correction.

Measuring instrument

Moving coil meter, $100\ \mu\text{A}$

Power supply

Universal transformer with voltage tapping plate for 110-125-145-200-220-245 V ($40-100\text{ c/s}$)

Consumption 20 W

Valves

EF 6 N (1 \times), EZ 40 (1 \times), EA 50 (1 \times), 4687 (1 \times), 6844 (1 \times)

Dimensions

Width 170 mm, height 250 mm, depth 220 mm

Weight

5.2 kg (including test prod)

Case

The unit is housed in a light-grey steel case with a leather carrying-handle.

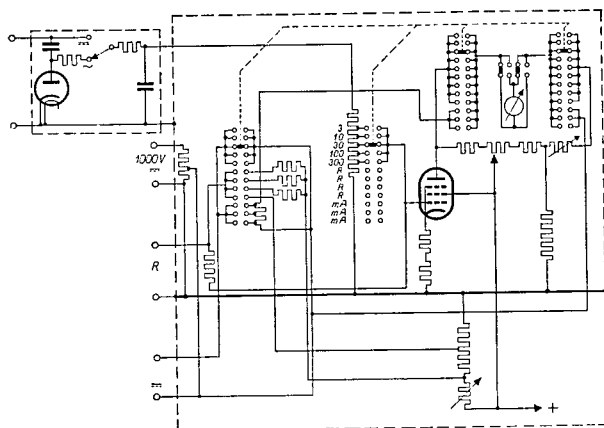

64016

Skeleton circuit of the GM 7635.

Cathode-ray oscilloscope GM 5655



This unit embodies the following features :

Two built-in, high-sensitivity amplifiers, one for horizontal deflection and one for vertical deflection. Built-in time-base. Automatic flyback suppression. Internal and external synchronization, the former being independent of the amplitude of the input voltage for vertical deflection. Built-in power unit with universal transformer, suitable for all mains voltages. Cathode-ray tube with 7 cm screen.

Uses in radio servicing

A separate test prod, GM 4575, is supplied, so that the unit can be used as a signal tracer or for the measurement of modulated R.F. signals up to at least 30 Mc/s. The instrument can be used with a "wobbulator" and, further, spans the whole of the A.F. range.

TECHNICAL DATA

Cathode-ray tube

The cathode-ray tube is the DG 7-2, which has a 7 cm screen with a short-persistence green fluorescence; it is particularly suitable for visual tests.

Amplifiers

Two identical amplifiers are used. Frequency range with maximum amplification : 6 c/s—100 kc/s, +0.5 db and -2.5 db; at 50 kc/s, -0.8 db.

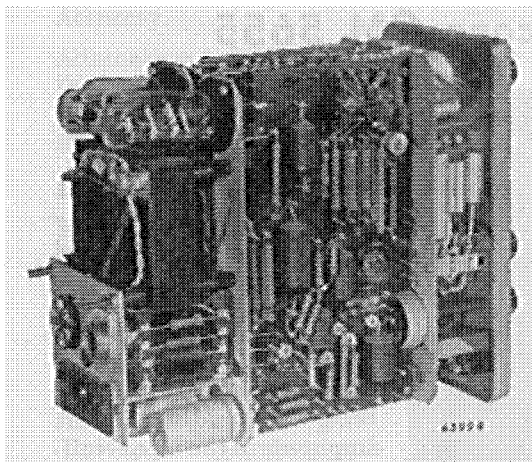

Interior view of the GM 5655; note the very compact, but readily accessible, arrangement.

a 6-position switch and continuously-variable fine control. The cathode-ray is suppressed automatically during the flyback. Synchronization: internal, with the frequency of the signal to be measured (independent of the amplitude), or external with the frequency of any signal. A signal of sufficient amplitude for the frequency modulator GM 2881 can be taken from the socket specially provided.

Inputs

Amplifiers: maximum input voltage $300 V_{RMS}$; input damping $1.1 M\Omega$ ($0.1 M\Omega$ without attenuation); input capacitance $50 pF$ (horizontal input $65 pF$), or $12 pF$ with attenuation.

External synchronization: maximum input voltage $30 V_{RMS}$, minimum input voltage $0.5 V_{RMS}$; input resistance $1.1 M\Omega$ and $0.1 M\Omega$; input capacitance $12 pF$ and $65 pF$. The input sockets for the horizontal amplifier can also be used for external synchronization voltages.

The GM 5655 used as a signal tracer

A 3-pin plug is provided for connection to the GM 4575, which incorporates an amplifier-detector. The signal obtained is applied to the input of the vertical amplifier.

Sensitivity

Vertical amplifier: approx. $30 mV_{RMS}/cm$
 Horizontal amplifier: approx. $45 mV_{RMS}/cm$

Attenuators

A fixed input attenuator of 1:13 and a continuously variable attenuator of 1:10,000 are provided for each of the two amplifier channels.

Time base generator

The frequency of the time base generator can be varied between 15 and 20,000 c/s by means of

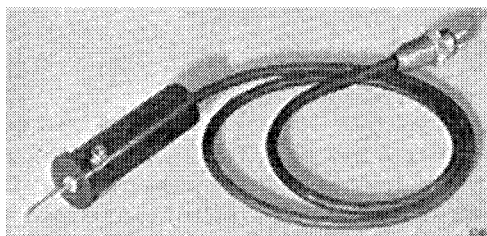

Test prod GM 4575. The plug is inserted in the socket at the rear of the oscilloscope.

Sensitivity: modulated (30%) R.F. signals of 50 mV_{RMS} produce a trace roughly 1 cm in height.

Power supply

Universal mains transformer with voltage tapping plate for 110, 125, 145, 200, 220 and 245 V, 40-100 c/s. Consumption: approx. 35 W.

Tube and valves

DG 7—2, ECH 21 (3×), EZ 2 (2×)

Dimensions

$11.5 \times 24 \times 29.5 \text{ cm}$

Weight

Approx. 6.4 kg

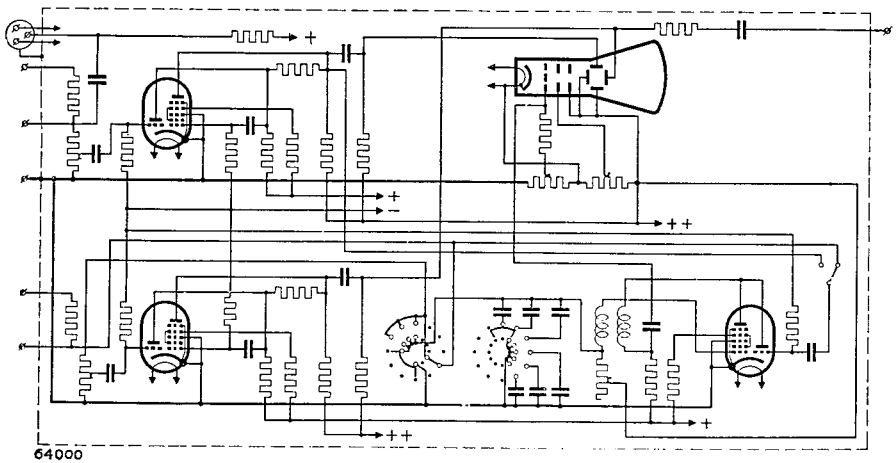

Skeleton circuit.

Calibrating oscillator GM 2885

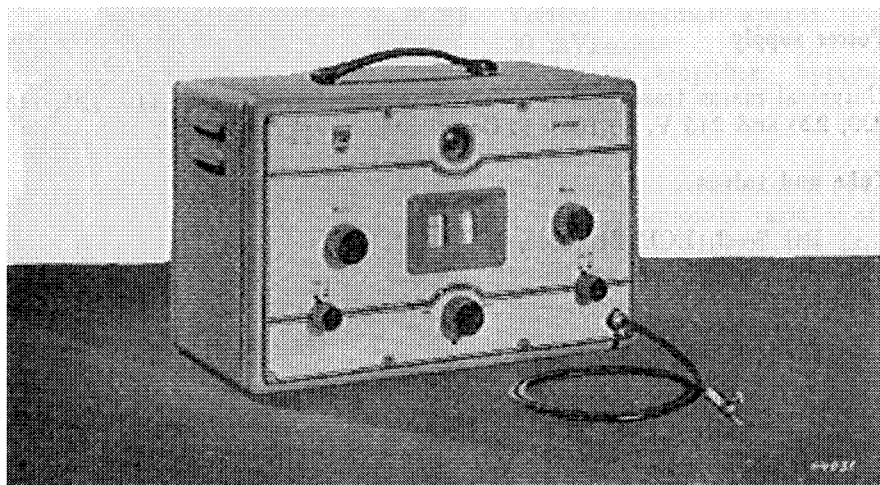

Application

The calibrating oscillator GM 2885 is intended for use in measurements requiring precisely known frequencies between 50 kc/s and 44 Mc/s. It is used inter alia for calibrating and checking the scales of band-spread receivers, for calibration work in laboratories, etc. High accuracy is ensured by a 1 Mc/s crystal oscillator, which precedes a selective amplifier having a frequency range of 6—22 Mc/s. Also incorporated in the unit is an auxiliary oscillator for a range of 0.5—1 Mc/s. By mixing the two oscillator frequencies, or their harmonics, signals are obtainable which are continuously variable between 50 kc/s and 44 Mc/s.

The fundamental wave with its many harmonics as generated by the crystal oscillator is modulated by an alternating voltage at mains frequency on the suppressor grid of valve B1. An external modulation voltage (50—1000 c/s) can also be employed, for which purpose a change-over switch is provided at the rear of the unit.

The two oscillators can be switched off individually, thus furnishing a check on the source of any signal obtained.

In order that the tuning will not be affected by a slight error in the scale reading, the unit is fitted with an electronic indicator (B5) of which the dark sector just disappears when the amplifier is accurately tuned to the various harmonics.

The output signal is transferred to the apparatus on test by means of a detachable, screened cable, whilst the signal voltage can be varied continuously by adjusting the grid bias of valves B2 and B3.

TECHNICAL DATA

Frequency range

50 kc/s—44 Mc/s

Crystal oscillator (I): 1 Mc/s

Auxiliary oscillator (II): 0.5—1 Mc/s

Accuracy of the frequency

Oscillator I: error < 100 c/s at 1 Mc/s

error < 2 kc/s at 20 Mc/s

Oscillator II: error < 2 kc/s at 1 Mc/s

Constancy of the frequency

At 1 Mc/s frequency drift in the auxiliary oscillator, brought about by mains voltage fluctuations of 10%, is less than 15 c/s. While the unit is warming up, the variation crystal oscillator frequency is less than 10 c/s, whilst frequency drift in the auxiliary oscillator after 15 minutes warming up is less than 1 kc/s at 1 Mc/s.

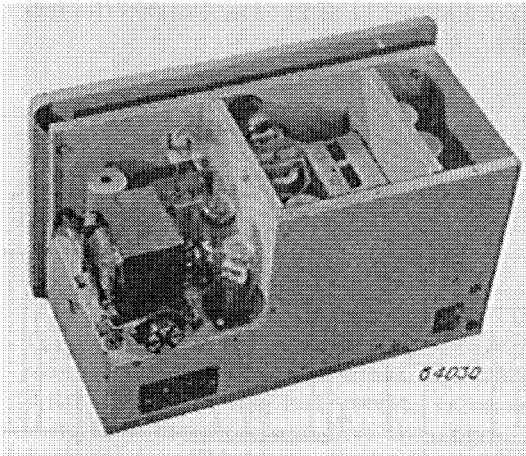

Interior of the GM 2885 (screening plate removed).

Scale accuracy

Oscillator I: Scale 6-22 Mc/s and 12—44 Mc/s: maximum error 1/5th of the difference between successive frequencies.

Oscillator II: Maximum error 3 kc/s.

Accuracy of control

Oscillator II is adjustable to within an accuracy better than 5 kc/s at 1 Mc/s, 6 kc/s at 10 Mc/s, 7 kc/s at 20 Mc/s, etc. Calibration of the auxiliary oscillator with the aid of the crystal oscillator ensures very accurate adjustment also at frequencies below 1 Mc/s.

R.F. output voltage

This is dependent on the frequencies selected for mixing: > 0.1 mV below 6 Mc/s, approx. 1 mV at 6—30 Mc/s, and about 0.5 mV at 44 Mc/s.

Continuous attenuator

Oscillator I: attenuation factor $> 2000x$ at 22 Mc/s
Oscillator II: „ „ $> 600x$ at 1 Mc/s
Mixed signal: „ „ $> 5000x$ at 22.7 Mc/s

Selectivity of the tuned circuits

When the amplifier following oscillator I is detuned by 1 Mc/s, the output voltage is reduced by a factor:

> 350 at 6 Mc/s	> 50 at 16 Mc/s
> 150 at 10 Mc/s	> 20 at 20 Mc/s

Modulation

Internal modulation at mains frequency: 30% at 1 Mc/s
External modulation at frequencies: 50—1000 c/s (10 V)

Output impedance

The output impedance is approx. 5600 ohms. The impedance across the terminals for external modulation is 0.1 M Ω .

Valves

EF 50, EBF 2, ECH 21, EZ 2, EM 4

Power supply

Universal transformer with voltage tapping plate for 110, 125, 145, 200, 220, 245 V (40—100 c/s)

Consumption

Approx. 25 W

Dimensions

Width 34 cm
Height 22 cm
Depth 20 cm (including knobs)

Weight 8.85 kg

Case

The unit is mounted in a light-grey steel case with a leather carrying-handle.

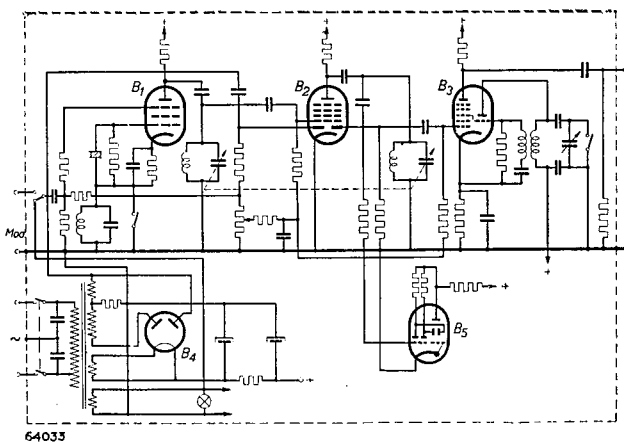

Skeleton circuit of the GM 2885.

"Cartomatic" III valve tester GM 7633



DESCRIPTION

The "Cartomatic" III valve tester is intended for the testing of valves in receivers, amplifiers and other equipment employing receiving valves. With the aid of this instrument, valves can be tested for the following:

1. cathode emission (and thus the slope),
2. short circuits between electrodes, with the valve cold or hot,
3. continuity of the electrode leading-in wires.

It is therefore possible by means of this unit to trace the more common faults encountered in valves.

OPERATION

A previously prepared "test card" made of insulating material and perforated to suit the type of valve to be tested enables the instrument to be operated very simply. The arrangement of the round perforations in the test card differs for each type of valve, and ensures that only the appropriate voltages are applied to the electrodes of the valve. When the lever on the instrument is pulled over, contact pins pass through the holes in the card and so establish electrical circuits for applying the necessary voltages to the various electrodes.

A meter incorporated in the unit indicates whether or not the emissive power of the cathode is within the lower reject limit. Inter-electrode short circuits are traced with the aid of 9 push-buttons and neon tube.

The neon tube also detects short circuits other than "dead shorts", reacting to an inter-electrode resistance of up to 3 MΩ.

Open circuits in the leading-in wires are traced with the aid of the same push-buttons and the meter, the former being numbered to correspond to the electrodes of the valve.

The test cards are inserted into a slot in the left-hand side of the instrument.

The "Cartomatic" III can be easily carried about: it incorporates a simple arrangement for compensating mains voltage fluctuations. An extra push-button is provided for checking the voltages as applied to the valve on test. When this button is depressed, the pointer should deflect to a special mark on the scale of the meter. By means of two knobs, one for coarse and the other for fine adjustment, the voltage can be accurately adjusted to the value required.

The instrument includes a valve holder (type P) for valves with side-contact bases, and a set of adapters for valves with other kinds of bases.

With the help of a punch, the necessary test cards can be prepared for all the valves listed in the book of instructions.

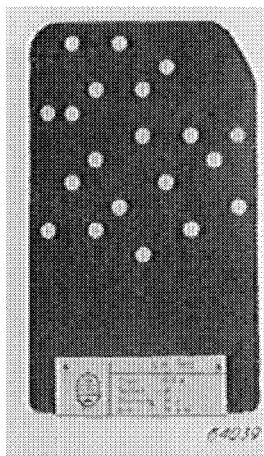

Example of a test card.

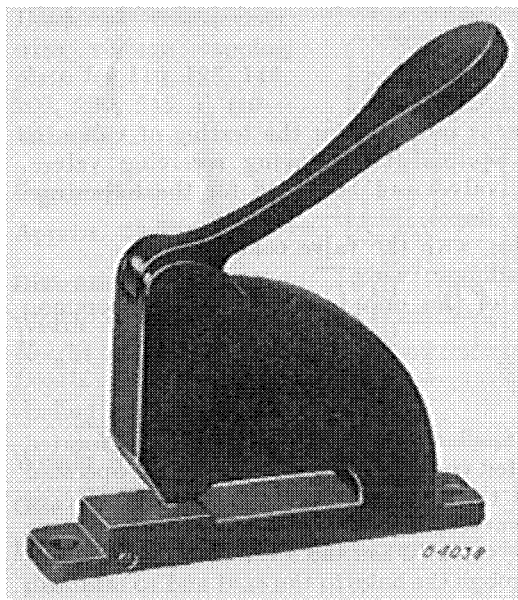

Punch for perforating the test card.

TECHNICAL DATA

Power supply

The unit is operated from A.C. mains, and has a tapping plate for 110, 125, 145, 200, 220 and 245 V supplies.

Without load, the instrument consumes about 7 W.

Valves

Neon tube 9512

Indicator lamp 7181

Weight and dimensions

Length 400 mm

Height 300 mm (excluding handle)

Depth 130 mm (190 mm including knobs and feet)

Weight approx. 10.5 kg

Electronic voltmeter GM 6005

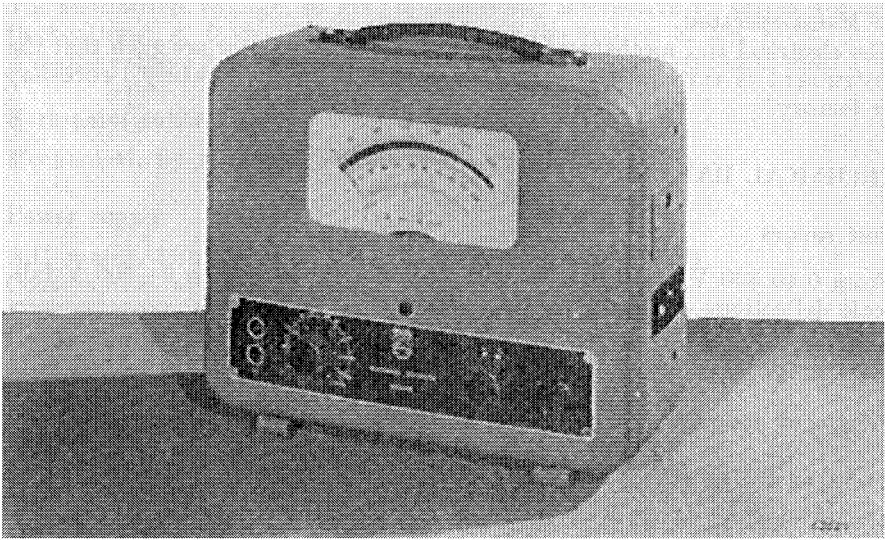

DESCRIPTION

The GM 6005 is a wide-range electronic voltmeter capable of measuring alternating voltages from 0.0005 up to 300 V at any frequency between 20 and 1000,000 c/s. The voltage range is divided into 10 steps of 10 dB each, so that an easy-to-read scale is obtained. The scale also includes a calibration in dB, whilst the instrument covers a range of -60 dB to $+52$ dB, where 0 dB = 1 mW per 600 ohms (0.775 V).

The voltages measured are indicated by a meter of 200 μ A, 2500 ohms, with a mirror-scale and a knife-edged pointer.

A calibrating voltage is built-in: with the switch in the "Contr." position, a constant voltage of 10 mV is applied to the input terminals of the instrument, which is then adjusted for full-scale deflection by means of a screw-driver adjustment. The deflection is practically independent of mains voltage variations.

The input terminals are screened. Since the input damping is high, the load imposed on the equipment to be tested is only small.

FEATURES

1. Wide frequency range.
2. Ten test ranges: 10 mV to 300 V full-scale deflection.
3. Easy to calibrate and check.
4. High input resistance.
5. Automatic current limitation to protect against overloading.

6. Linear, anti-parallax scale with knife-edge pointer.
7. Insensitive to mains voltage fluctuations.
8. Mains-operated.

The electrical and mechanical properties of this voltmeter are such that the instrument is suitable for universal application in laboratory, workshop or factory.

TECHNICAL DATA

Test ranges

From 0 to 300 V in 10 overlapping ranges of 0—10 mV to 0—300 V full-scale deflection. Similarly from —60 to +52 dB.

Frequency range

20 c/s to 1 Mc/s

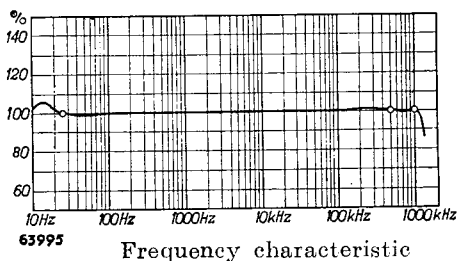

Accuracy

The error due to deviations in the frequency characteristic (relative accuracy) is as follows:

100 c/s—500 kc/s: < 1%,

20 c/s— 1 Mc/s: < 2%,

or, for absolute measurements :

100 c/s—500 kc/s: < 4%,

20 c/s— 1 Mc/s: < 5%.

Dial

Embodies three scales, viz. 0-100; 0-316 and — ∞ to +12 dB.

Attenuator

Ten stages of 10 dB each, and a checking position.

Input damping

From 10 mV to and including 1 V: 20 kc/s > 1.5 MΩ,

1 Mc/s > 0.7 MΩ.

From 3 V to and including 300 V: 20 kc/s > 1.9 MΩ,

1 Mc/s > 0.7 MΩ.

Input capacitance

From 10 mV up to 1 V < 15 pF

From 3 V up to 300 V < 6 pF

Calibration

The calibration voltage, 10 mV, is practically insensitive to mains voltage fluctuations: $< 0.5\%$ on a mains voltage fluctuation of 5% .

A mains voltage fluctuation of $+ \text{ or } - 5\%$ causes a test error of at most 1% .

Zero-point calibration

Mechanical, by means of screwdriver adjustment.

Power supply

A.C. mains, 110, 125, 145, 200, 220, or 245 V, 40—100 c/s

Consumption approx. 27 W

Valves

EF 41, EF 51, EF 50, ECH 21, EZ 2, 8073 D/00 (2 \times)

Dimensions

34 \times 28 \times 17 cm

Weight

Approx. 8 kg

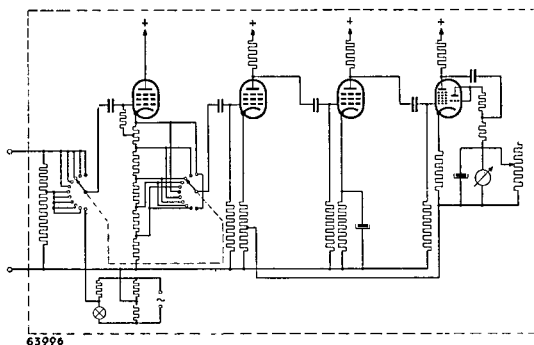

Skeleton circuit.

Universal bridge GM 4144

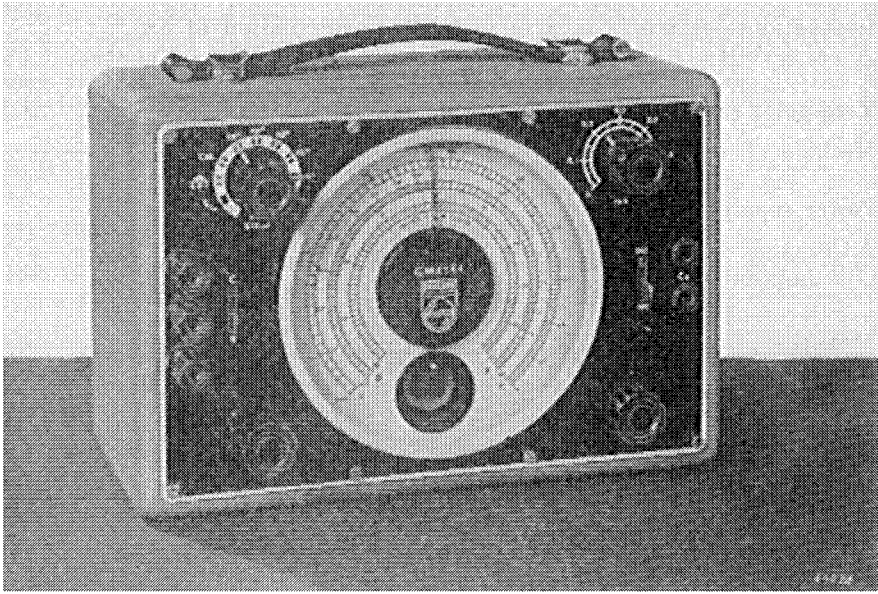

Possible applications of the GM 4144

1. Measuring capacitors
2. Measuring resistors
3. Measuring self-inductance by comparison
4. Measurement of loss angles or "tan δ "
5. Measuring electrolytic capacitors
6. Measuring insulation resistance of paper capacitors
7. Phase correction at high resistance values

Features of the instrument

1. Scale for variations as a percentage
2. "Open bridge" setting
3. Large, wide-angle scale, viz. 1 : 10
4. High accuracy
5. Forming voltages for electrolytic capacitors
6. Inertia-less electronic indicator
7. Scale giving direct readings
8. Direct zero calibration possible
9. High, variable sensitivity
10. Bridge can be fed with alternating voltage from external sources

DESCRIPTION

The principle of the GM 4144 is based on the Wheatstone bridge. The galvanometer incorporated in the instrument is in effect an electronic circuit, com-

prising an amplifier with electronic indicator. By means of this instrument inductances such as chokes can also be measured. Individual variations of -20 to $+25\%$ among coils, resistors or capacitors can be read directly as percentages.

TECHNICAL DATA

Measuring ranges

Capacitances: 10 pF—100 μ F, divided into 6 ranges:

10— 100 pF	0.005— 0.1 μ F
50— 1000 pF	0.05 — 1 μ F
500—10,000 pF	1 —100 μ F

Measurement of capacitances as low as 1 pF is possible.

Loss angles: $\tan \delta$ of from 0—0.6 for capacitors of 1—100 μ F.

Forming voltages for electrolytic capacitors: 12.5 - 25 - 50 - 100 and 250 V, D.C.

Leak test: Capacitor leakages up to 200 M Ω can be detected.

Resistance: 0.5 ohm—10 M Ω , in 6 ranges:

0.5— 10 ohms	500 —10,000 ohms
5 — 100 ohms	0.005— 0.1 M Ω
50 —1000 ohms	0.1 — 10 M Ω

Variable phase correction, for exact adjustment of minimum, is available in the range 0.1—10 M Ω .

Accuracy of measurement

Normal ranges (outer scale): < 0.3 — 0.8%

Extra ranges (inner scale): < 0.6 — 3%

The lower value is applicable to the central part of the scale, the higher to the extremities.

Electrical error: $< 2\%$ at centre of scale

Accuracy at low capacitance values: better than $1\frac{1}{2}$ pF

“Percentage” position: absolute accuracy better than 0.3%

“Testing” position: better than 1%

“Open bridge” position: better than 1%

Power supply

A.C. mains, 110, 125, 145, 200, 220, or 245 V, 40—100 c/s

Consumption: approx. 17 W. Bridge supply: internal, mains frequency; external, max. 3 V

Valves

EF 40, EM 4, EZ 40

Dimensions and weight

170 × 250 × 130 mm; 6 kg

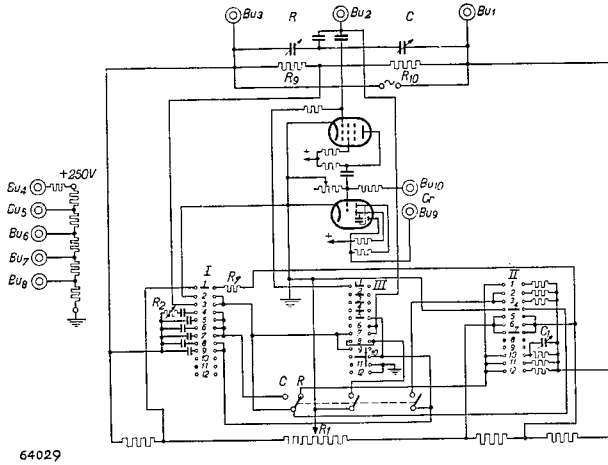

Skeleton circuit of the GM 4144.

Diode-voltmeter GM 6004

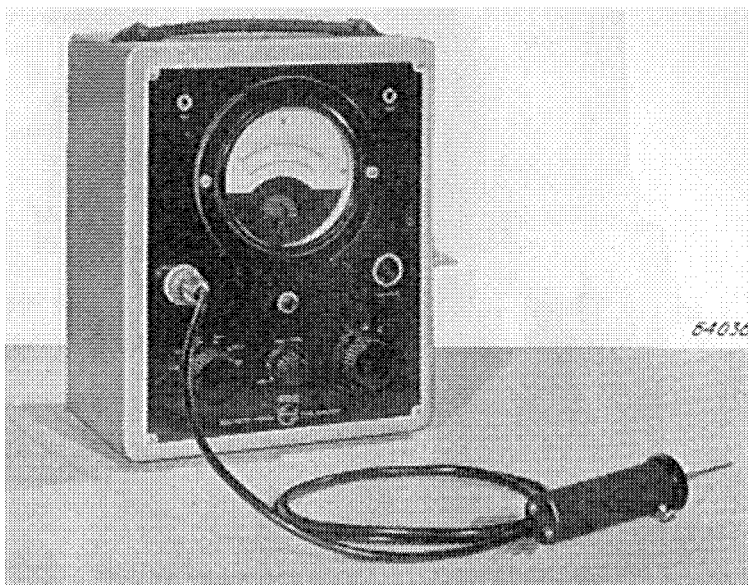

Diode-voltmeter suitable for measuring direct and alternating voltages from 0 to 300 V at frequencies of 50 c/s to 100 Mc/s.

FEATURES

Separate, interchangeable test prod.

High accuracy.

Illuminated, linear scale.

Mains-operated.

Almost completely unaffected by mains voltage fluctuations.

Built-in attenuator control.

Capable of measuring both positive and negative voltages.

Calibration independent of the valves; simple zero-point setting

Zero-point adjustment independent of the test range.

Automatic protection, should the A.C./D.C. switch be in the wrong position.

TECHNICAL DATA

Test ranges

Alternating and direct voltages, 0—300 V, in 5 ranges: 3, 10, 30, 100 and 300 V; full deflection.

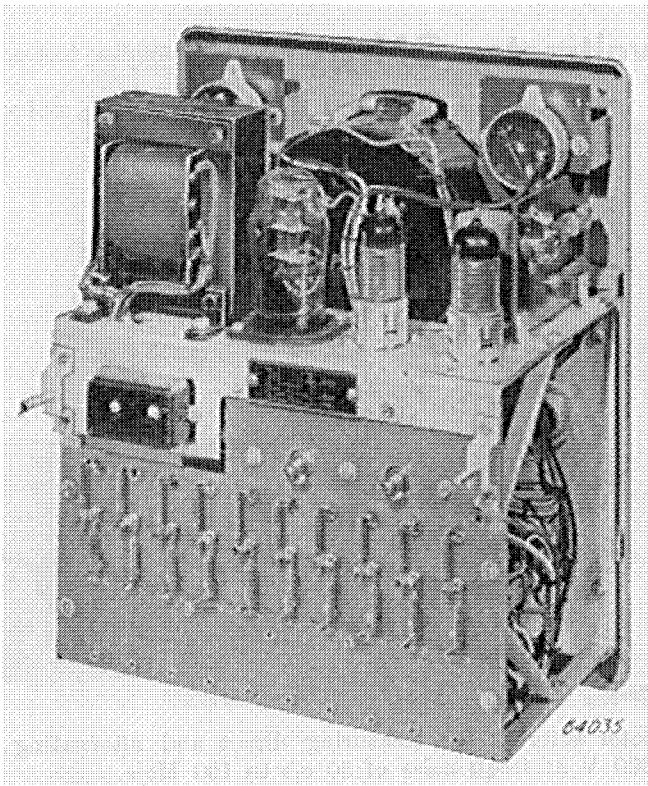

Interior view of the diode-voltmeter (back-plate removed), clearly showing the adjustable contacts for each measuring range. The adjustments in no way affect each other.

Frequency range

50 c/s—100 Mc/s.

Accuracy

Absolute: at 50 c/s—50 Mc/s, better than 3%.

At 100 Mc/s, increasing to max. +10%.

Calibration accuracy: better than 1% at all frequencies.

The effect of mains voltage fluctuations

The maximum variation due to mains voltage fluctuations of 5% is < 1.6% in the 3 V range, < 0.5% in the 10 V range, and is negligible at the higher voltages.

Measuring instrument

Moving-coil meter with knife-edge pointer, 100 μ A, 5000 Ω , illuminated dial.

Input

Asymmetrical

Direct voltages :

3, 10 and 30 V-range, 15 M Ω

100 and 300 V-range, 10 M Ω

Alternating voltages :

0.1 Mc/s: approx. 3.0 M Ω

1.5 Mc/s: „ 1.3 M Ω

15 Mc/s: „ 0.3 M Ω

40 Mc/s: „ 0.1 M Ω

Input capacitance

Approximately 9 pF

Power supply

Universal transformer

110/125/145/200/220/245 V.

Consumption : approx. 20 W

Valves

Two diodes EA 50

Two amplifying valves EF 40

One rectifying valve EZ 2 or EZ 40

One pilot lamp 6844

Dimensions

29×22.5×18 cm, including the control knobs

Weight 6.5 kg

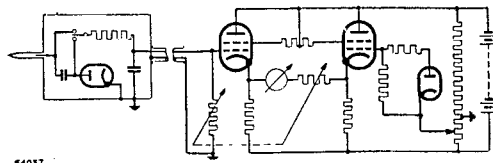

Skeleton circuit.