

THE
BALLAST TUBE
HANDBOOK

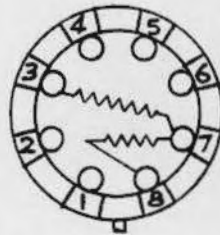
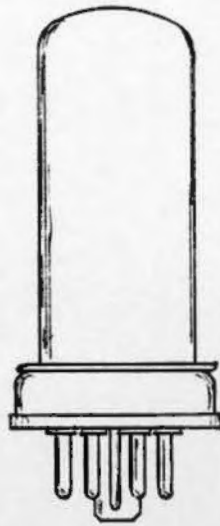

Compiled By
A.P. Jacobi

The BALLAST TUBE Handbook

Contents

Introduction	2
Brief History	3
Replacing Ballasts	4
Manufacturers List	5
Listing of Individual Types	6
Notes	54
Chart No. 1 Standard RMA Codes	60
Chart No. 2 Non-Standard Codes	61
Chart No. 3 Universal Replacements	63
(Clarostat, NU, GE, Philco)	
Chart No. 4 Universal Replacements	64
(Amperite)	
Chart No. 5 Majestic Ballast Tubes	65
Chart No. 6 JFD Adjustable Ballasts	66
Chart No. 7 Cartridge Ballasts	69
RCA Ballast Cross Reference	70
Tube Base Diagrams	71

Compiled By

A P Jacobi
Ralston, Nebr.

Issue No. 3

Copyright 1988

BALLAST TUBES

INTRODUCTION

Of all the tubes used during the golden age of radio, probably the least known and the least cared about (among service people at any rate) was the ballast tube. However, it played an important part in the scheme of radio--and, especially for the collectors of old time receivers, it needs to be remembered. In that light, this manual has been assembled.

The tubes that we are involved with here are actually three types: ballast tubes (current regulators), plug in resistors, and a combination of both. For the sake of simplicity, we have lumped all together and called them ballasts--as did most people in the industry.

While information on regular radio tubes is readily available today, it is very scarce on ballast tubes. With that in mind we hope this effort is of some help. Although the technical data is not complete on all the numbers listed, much effort has been made to insure accuracy of the material presented. Human frailties being what they are, errors are bound to creep in. So, if readers have any additional information not covered or corrections, please let us know.

The book is presented in four sections. First, the listing of the tube numbers with use, basic technical information, and when possible, a reference in Rider's Manuals where actually used. Second, a chart section with information on numbering and basing codes, and special tubes. Third, a notes section that expands the information presented in the first listing. Fourth, the most commonly used base diagrams.

There are both American and European types listed. American manufacturers are lumped under one category, USA, but European are listed individually where possible to further identify them. A very few types were manufactured both in Europe and the USA so numbers may conflict. Some caution should be used when working with European tubes as some manufacturers used the same type numbers but the operating characteristics are somewhat different. Conversely, some made tubes with the same characteristics but used different type numbers. The letter G after a tube type has been left off type numbers listed except in a few special cases.

A P J

BRIEF HISTORY

A ballast may be defined as an automatically compensated resistor for controlling current. This is done by what is called 'Ballast Action'. True ballast tubes are constructed of a material that has the characteristic to offer high resistance to high voltage or current, and low resistance to low voltage or current. A plug in resistor on the other hand will present a fairly constant resistance with regard to changes in voltage and current. The combination of the two uses a constant resistance for the greater voltage dropping section and a 'ballast' resistance for the section(s) for pilot light voltage(s).

The earliest form of a ballast was the cartridge ballast which resembled a large fuse. (See Chart 7). This was introduced about 1922. In 1930 the glass bulb ballast tube appeared. Some of the earlier versions of ballast tubes were 1.0 volt units with various current ratings. These were used with the 2 volt tube receivers in order to use 3 volt batteries for the filament supply. Thus, either a 2 volt storage battery (cell) or a 3 volt dry cell type could be used. The voltage applied would remain fairly constant as the battery voltage gradually dropped. Of course the correct ballast had to be used, determined by the total tube filament drain.

About 1927, AC operated receivers made their appearance and AC power supplies (Battery Eliminators) were becoming common to operate the older battery radios. In the earlier years, line voltages varied considerably across the country. Many communities had only DC available while others had AC. The line voltages might be 110, 120, or 230 volts basically and the AC types have a frequency of 25, 40, 50, or 60 cycles. Voltage also could vary as much as 30 volts during a day's use. To say the least, regulation was a problem.

To compensate for changing line voltages, many manufacturers used tapped primaries on the power transformers. This was fine if there were a means to monitor the voltage. A better method consisted of using a 'line ballast'. There were two types: The accessory ballast and the built-in ballast.

The accessory ballast was a unit that plugged into the wall socket, and the radio cord plugged into it. When the line voltage was normal or low, the voltage drop in the ballast was negligible. But as the line voltage increased, the ballast resistance increased so that voltage applied to the receiver remained within acceptable limits.

The built in ballast was a part of the radio chassis, designed for a definite transformer primary and secondary load. In these, the primary was wound for a voltage (approximately 80 to 90), with the ballast then in series taking up the necessary voltage drop between the primary voltage and the full line voltage. Since the resistance of the ballast automatically rises and falls with the line voltage, the applied voltage to the primary remained fairly constant.

To cut costs and make receivers more compact, sets were also built without power transformers. These had all the tube filaments hooked in series with a voltage dropping resistor to add up to the line voltage. Besides being cheaper to build, they could be operated on AC or DC lines--and there were a lot of DC power lines around then. But this dropping resistor created a lot of heat under the chassis. So, along came the line cord resistor-

out in the open air. This worked fairly well, but had problems. It was difficult to replace and created a fire hazard. Finally, the dropping resistance was mounted on a tube base and enclosed in a glass or metal envelope. This could be plugged in on top of the chassis with plenty of ventilation and could be easily replaced.

About 1935 octal base tubes appeared. The octal base then became pretty much the standard for ballasts since it provided a greater number of pins for tap-offs. This was an advantage, since basic line voltages varied considerably from area to area, the ballast could then be designed to accommodate a wide range of values. In general, most of the tubes were designed for a standard 110 or 115 volt line with the resistance set according to what voltage was to be dropped. A 300 MA current drain was considered standard for these types. One or more tap-offs were often included for pilot lamps used in the set.

Around 1941 the 12, 35, and 50 volt filament tubes appeared using 150 MA current. With the proper combination of these in series to add up to the line voltage, the ballast tube was no longer needed. So, by 1942, the ballast tube passed into oblivion as far as new equipment design was concerned.

REPLACING BALLASTS

Replacing ballasts with an identical type generally should present no problems, especially the glass bulb types. However, the metal types can give troubles with high resistance connections inside the metal shell. Those connections tend to oxidize over the years since they were built. When replacing ballasts with another similar type, some precautions should be taken. Many units use pin 1 for ground while others use 4. Manufacturers often used some ballast socket connectors for tie points; therefore, check the circuit to be sure these will not connect to the replacement where not wanted. 'Universal' replacement types often have connections to most of the base pins, so if some are going to interfere they can be clipped off to avoid unwanted connections. In the case of special base types no longer available, an adaptor is needed or the socket will have to be changed to accommodate a replacement. For more detailed replacement information, see our companion manual 'The Ballast Tube Substitution Guide'.

MANUFACTURERS LIST

(BA)	-----	British Army Tube
Cast. (Castilla)	-----	Madrid, Espana (Spain)
Dario	-----	Paris, France
Fotos	-----	Paris, France
GeMar. (GeMarOs)	-----	*
Long. (Longlife) N V Thermion	-----	Nederland
Lor. (Lorenz)	-----	*
Marat. (Marathon) Philips	-----	England
Mazda	-----	England & France
Mull. (Mullard)	-----	England
Osram (Gecovalve)	-----	England
Phil. (Philips)	-----	Nederland or England
Rec. (Record)	-----	Hungary
Rectr. (Rectron)	-----	Germany
Sator (Tungram)	-----	Ujpest, Hungary
S-H (Siemens-Halske)	-----	Germany
Stab. (Stabilivolt)	-----	*
Tele. (Telefunken)	-----	Germany
Therm. (N V Thermion)	-----	Nederland
Trio. (Triotron)	-----	England
Tung. (Tungram)	-----	Ujpest, Hungary
Ultr. (Ultron) (Mazda)	-----	England & France
USA	-----	United States of America
Valvo (Philips)	-----	Germany
Vatea	-----	Hungary
Viss. (Visseaux)	-----	France

* = No information

BALLAST TUBE LISTING

Codes:

* - Maximum Voltage
 ‡ - Needs Verifying
 A - 110-120 V. AC-DC Sets
 B - 2 V. Battery Sets
 C - 110-120 V. AC Sets
 H - 220-240 V. AC-DC Sets

R - 110-120 V. AC Sets w/70-90 V. Primary of power transformer.
 S - Special Apparatus
 SP - Special Socket
 T - Television Receiver

Type	Use	Manuf.	Volt.	Ma.	Base	Notes	Rider's Refer.
A (JFD)		USA	Universal	Repl. Type		See Chart 6.	
A-16037 (16037)	A	"	17	300	43		
A-16040 (16040)	A	"	49	300	33	Equiv. to K49C	
A-16042 (16042)		"					
A-16043 (16043)		"					
B (JFD)		USA	Universal	Repl. Type		See Chart 6.	
B	B	"	1.2	500	6	United Amer. Bosch	5-33
B (Majestic)	B	"	35		3	See Chart 5.	
-B	S					123, Searle 5S1-8	15-1
B 0828		Osram	0.4-1.2	275	5		
B 0850		"	0.4-1.2	500	5		
B 0870		"	0.4-1.2	700	5		
B 08110		"	0.4-1.2	1100	5		
B9M15822	T	USA				Rathou-Belmont TV.	
B9M16067	T	"				" " "	
B9M16275	T	"				" " "	
B9M16534	T	"				" " "	
B9M16822	T	"				" " "	
B9M17571	T	"				" " "	
B9M18941	T	"				" " "	
B13		Mull.	200	200	66		
B13A		"	100	200	66		
B13B		"	200	200	67		
B66A	A	USA	66	300	28		
B86A	A	"	86	300	28	RCA OSC-22	11-61
B128		Osram	0.5-1.5	280	5		
B150		"	0.5-1.5	470	5		
B2221		USA					
BBR	C	"					
BE 10663	S	"				125, Mont. Ward 04BR-397A	13-1
EK3AJ	A	"	3	300	29	Sparton 409-GL	10-2
EK11B	A	"	11	300	33		
EK11C	A	"	11	300	33		
EK11D	A	"	11	300	36		
EK15B	A	"	15	300	33		
EK17B	A	"	17	300	33		
EK17C	A	"	17	300	33		
EK17D	A	"	17	300	36		
EK17E	A	"	17	300	43		
EK17E1	A	"	17	300	33	Allied Rad. Corp. E10807	14-45
EK23B	A	"	23	300	33	Port-O-Matic 18A	10-1
EK23C	A	"	23	300	33		
EK23D	A	"	23	300	36		
EK23E	A	"	23	300	43		
EK24C	A	"	24	300	33		
EK29B	A	"	29	300	33		
EK29C	A	"	29	300	33		
EK29D	A	"	29	300	36	Echophone EC-3	13-5
EK-29D-10	A	"	29	300	36		
EK30B	A	"	30	300	33		
EK30C	A	"	30	300	33		
EK30D	A	"	30	300	36		
EK30H	A	"	30	300	45		
EK32D	A	"	32	300	36		
EK36	A	"	36	300	36	Echophone EC-2	13-1
EK36B	A	"	36	300	33	Analey U-10	7-4
EK36C	A	"	36	300	33		
EK36D	A	"	36	300	36		
EK36E	A	"	36	300	43		
EK36F	A	"	36	300	44		

Type	Use	Manuf.	Volt.	MA.	Base	Notes	Rider's Refer.
BK 36H	A	USA	36	300	45		
BK 42B	A	"	42	300	33	Sears 101.546	11-15
BK 42C	A	"	42	300	33	Troy 179	8-4
BK 42D	A	"	42	300	36	Detrola 135	8-4
BK 42E	A	"	42	300	43		
BK 44BJ	A	"	44	300	42	Sparton 5028	10-33
BK 47B	A	"	47	300	33	Detrola 212	9-10
BK 49B	A	"	49	300	33	Detrola 211	9-9
BK 49C	A	"	49	300	33		
BK 49CJ	A	"	49	300	42		
BK 49D	A	"	49	300	36	Carod 60	7-2
BK 49-D10	A	"	49	300	36		
BK 49E	A	"	49	300	43		
BK 51DJ	A	"	51	300	21		
BK 52H	A	"	52	300	45		
BK 55B	A	"	55	300	33	Detrola 130	8-3
BK 55BJ	A	"	55	300	42	Sparton 5008	10-27
BK 55C	A	"	55	300	33	Detrola 158A	8-11
BK 55D	A	"	55	300	36		
BK 55E	A	"	55	300	43		
BK 55P	A	"	55	300	44		
BK 61B	A	"	61	300	33	RCA R-91 (Phono)	13-62
BK 61C	A	"	61	300	33		
BK 61D	A	"	61	300	36		
BK 61E	A	"	61	300	43		
BK 61H	A	"	61	300	33	RCA	13-14
BK 63B	A	"	63	300	33		
BK 67B	A	"	67	300	33		
BK 67BJ	A	"	67	300	42		
BK 67C	A	"	67	300	33		
BK 67D	A	"	67	300	36		
BK 80B	A	"	80	300	33	Sparton 219 P, (Phono)	10-1
BK 86B	A	"	86	300	33		
BK 168-B12	H	"	168	300	49	Sparton 5008	10-27
BK U126D	S	"			19	71. Philco 39-751	11-38
BK U172B	S	"			18	70. Philco 39-711	11-37
BK V51DJ	A	"	51	300	16	1. Philco 39-118	11-31
BL 17B	A	"	17	300	33		
BL 17C	A	"	17	300	33		
BL 17D	A	"	17	300	36		
BL 23B	A	"	23	300	33		
BL 23C	A	"	23	300	33		
BL 23D	A	"	23	300	36		
BL 24C	A	"	24	300	33	Warwick 749	10-26
BL 30B	A	"	30	300	33		
BL 30C	A	"	30	300	33		
BL 30D	A	"	30	300	36		
BL 36B	A	"	36	300	33		
BL 36C	A	"	36	300	33		
BL 36D	A	"	36	300	36		
BL 42B	A	"	42	300	33	GE HJ-612	11-61
BL 42C	A	"	42	300	33	GE H 634	11-71.72
BL 42D	A	"	42	300	36	GE 20	14-5
BL 42P	A	"	42	300	44		
BL 49B	A	"	49	300	33	GE GD 62	10-13
BL 49C	A	"	49	300	33	GE FD 625	9-13,14
BL 49D	A	"	49	300	36		
BL 55B	A	"	55	300	33	GE GD 51	10-11
BL 55C	A	"	55	300	33		
BL 55D	A	"	55	300	36		
BL 55P	A	"	55	300	44		
BL 61B	A	"	61	300	33		
BL 61C	A	"	61	300	33		
BL 61D	A	"	61	300	36		
BL 67B	A	"	67	300	33		
BL 67C	A	"	67	300	33		
BL 67D	A	"	67	300	36		
BM 17B	A	"	17	300	33		
BM 17C	A	"	17	300	33	Goodyear 749	10-20
BM 17D	A	"	17	300	36		
BM 17E	A	"	17	300	43		
BM 23B	A	"	23	300	33		
BM 23C	A	"	23	300	33		
BM 23D	A	"	23	300	36		
BM 23E	A	"	23	300	43		
BM 24C	A	"	24	300	33		
BM 29C	A	"	29	300	33	Automatic 878	9-4

Type	Use	Manuf.	Volt.	MA.	Base	Notes	Rider's Refer.
BM30B	A	USA	30	300	33		
BM30C	A	"	30	300	33		
BM30D	A	"	30	300	36		
BM36	A	"	36	300	33	Automatic B-80	8-6
BM36B	A	"	36	300	33		
BM36C	A	"	36	300	33	Lafayette D-33	14-60
BM36D	A	"	36	300	36		
BM36E	A	"	36	300	43		
BM42	A	"	42	300	33	Automatic B-70	8-6
BM42B	A	"	42	300	33	Warwick 10-70	11-6
BM42C	A	"	42	300	33		
BM42D	A	"	42	300	36		
BM42E	A	"	42	300	43		
BM43B	A	"	43	300	33	Automatic 975	11-3
BM49A	A	"	49	300	28	Automatic 892	9-5
BM49B	A	"	49	300	33	Automatic 939	11-3
BM49C	A	"	49	300	33	Automatic B 40	8-4
BM49D	A	"	49	300	36		
BM49E	A	"	49	300	43		
BM49F	A	"	49	300	44		
BM49G	A	"	49	300	44	Automatic 892	9-5
BM49H	A	"	49	300	45		
BM50B	A	"	50	300	33		
BM50C	A	"	50	300	33		
BM50D	A	"	50	300	36		
BM55B	A	"	55	300	33	Automatic D55	9-1
BM55C	A	"	55	300	33		
BM55D	A	"	55	300	36		
BM55E	A	"	55	300	43		
BM55F	A	"	55	300	44		
BM61B	A	"	61	300	33		
BM61C	A	"	61	300	33		
BM67B	A	"	67	300	33		
BM67C	A	"	67	300	33		
BM74B	A	"	74	300	33		
BM74C	A	"	74	300	33		
BM80B	A	"	80	300	33		
BM80C	A	"	80	300	33		
BM88B	A	"	88	300	33		
BR 201		Tung.	90-230	200			
BR 201B		"	40-100	200			
BR 3000a		"	7.0-18	3000	1		
BT 1000	H	USA	115	150	29	Continental J 6	12-10
BU 200		Mazda	30	1150	80		
C (JFD)		USA	Universal Repl. Type.			See Chart 6.	
C 1		Phil.	80-200	200	66		
C 2		"	35-100	200	66		
C 3		"	100-200	200	67		
C 4		"	55-105	200	72		
C 4B	S	USA				32. Andrea 410, 411	8-10
C 5B	S	"				47. Andrea 511	9-23
C 6		Phil.	70-100	200	66		
C 7		"	35-70	200	66		
C 8		"	80-200	200	67		
C 9		"	35-100	200	66		
C 10		"	35-100	200	72		
C 11		"					
C 12 160 V. Line		"	35-100	200	69		
C 12 250 V. Line		"	80-200	200	69		
C-376 (376)	R	USA	-Replace with 876-		1	Columbia 900	1-4
C-386 (386)	R	"	-Replace with 886-		1		
C-8064A		"					
C-8064B		"					
C-8064C		"					
C-8064D		"					
C-9266	A	"	43	150	-	214.	
CL-610-10 (610-10)	B	"				Packard Bell 48	7-3
CV 1		Vatea	200*	200	66		
CV 2		"	100	200	66		
CV 3		"	200*	200	67		
CV 1200		(BA)	200	200			
CV 1202		"	165*	300			
D5-10	S	USA	12-30	50			
D5B (D5-B)	S	"				33. Andrea 520, 521	8-11
D510M2		"					

Type	Use	Manuf.	Volt.	MA.	Base	Notes	Rider's Refer.
D5TF30	S	USA	20-40	35-40	53		
D6-1	B	"	0.3-1.2	60	6		
D6-1E	"	"					
D6-4	"	"					
D6-10	S	"					
D6-11	"	"					
D6B	S	"				47. Andrea 620	9-28
D6M2	"	"					
D6T4	"	"			50	7 pin min.	
D6T11	"	"			50	7 " "	
D6TF10	"	"	12-30	60-68	53	9 " "	
D6TF11	"	"			53	9 " "	
D6TF20	"	"	20-40	60*			
D6TF30	"	"					
D7H4	"	"					
D7HT4	"	"			50	7 pin min.	
D7HT11	"	"			50	7 " "	
D-11	B	"	0.4	250	5	See Chart 7.	
D14B	"	"				34. Andrea 1401	8-12
D14BS	"	"				35. Andrea 1401	8-12
D-30	"	"					
D-34	"	"					
D-35	A	"	12	300		Dewald 1200	8-6
D-61	"	"		60			
D-98 (98)	B	"	30	980	7	Brunswick 31	3-8
D-105 (105)	H	"	30	1050	7	Brunswick 31	3-8
D-110 (110)	H	"	30	1100	7	Brunswick 31	3-8
D-126 (126)	R	"	30	1260	7	Brunswick S-14	1-32
D-140	A	"					
D-150	A	"				Dewald 1200	8-6
D-200	A	"				Dewald 1200	8-6
D-740	A	"				Dewald 1201	9-8
D-4831 A	"	"					
D-5468	"	"					
D-9085	S	"		300		57. MarconiPhone Vanity1938	10-1
D-99946	"	"					
E6B	S	USA				48. Andrea 630	9-31
E157	A	"	34	150	-	215.	
E658A	A	"		300		58. MarconiPhone D8 (1938)	10-3
E658B	A	"	55	300		58. MarconiPhone D8 (1938)	10-3
E5748	S	"		300		66. Porto-Matic 25A	10-2
E7999	A	"	22	150	33	Dewald 655	10-5
E14980	"	"					
EM498	"	"					
EU I		Osram	110-220	180	80/82		
EU II	"	"	55-110	180	80/82		
EU III	"	"	25-50	180	80/82		
EU IV	"	"	60-160	180	80/82		
EU V	"	"	35-70	180	80/82		
EU VI	"	"	110-220	200	67		
EU VII	"	"	50-100	200	71		
EU VIII	"	"	75-150	200	70		
EU IX	"	"	95-190	200	67/68		
EU X	"	"	35-70	200	72		
EU XII	"	"	85-170	200	70		
EU XIII	"	"	25-50	200	66		
EU XIV	"	"	50-100	200	66		
EU XV	"	"	40-80	200	78		
EU XX	"	"	35-70	200	72		
EW 0202		S-H	2.0-6.0	250	1		
EW 0301	"	"	1.0-3.0	300			
EW 0404	"	"	4.0-10	410	1		
EW 0405	"	"	5.0-15	440	1		
EW 0405b	"	"	4.5-13	400	1		
EW 0417	"	"	17-45	430	1		
EW 0450	"	"	50-150	430	1		
EW 0501	"	"	1.5-4.5	500	1		
EW 0502	"	"	2.4-3.6	550	1		
EW 0502b	"	"	2.0-6.0	500	1		
EW 0506	"	"	6.0-17	500	1		
EW 0550	"	"	50-150	500	1		
EW 0603	"	"	3.0-9.0	550	1		
EW 0620	"	"	20-60	600	82		
EW 1	"	"	2.4-6.0	550	1		
EW1		Osram	80-240	200	66		
EW2	"	"	35-103	200	66		

Type	Use	Manuf.	Volt.	MA.	Base	Notes	Rider's Refer.
EV 2		S-H	1.5-3.0	1100	1		
EV 9		Owram	35-103	200	66		
EV 12		"	35-105	200	64		
EV12		"	60-240	200	66		
EV 16		S-H	2.5-6.5	1100	1		
EV 20		"	4.3-9.5	1100	1		
EV 23		"	4.0-10	410	1		
EV 28b		"	17-45	430	1		
EV 85-255/80		Lor.	85-255	80	1		
EV117		S-H	50-150	430	1		
EV 120		"	3.0-9.0	1300	79	216.	
EV 121		"	3.0-24	1400	79	217.	
EV 122		"	20-60	600	82		
EV 126		"	6.0-17	1100	1		
EV 127		"	1.0-3.0	300			
EV 130		"	25-75	100		218.	
EV 131		"	25-75	60		219.	
EV 503		"	2.5-7.5	500	1		
EV 1005		"	5.0-14	1000	82		
EV 1090		"	2.5-5.0	2100	1		
EV 1101		"	1.5-3.0	1100	1		
EV 1102		"	2.5-6.5	1100	1		
EV 1104		"	4.5-9.5	1100	1		
EV 1106		"	6.0-17	1100	1		
EV 1110		"	10-25	1100	1		
EV 1150		"	50-150	1100	1		
EV 1303		"	3.0-9.0	1300	82		
EV 1408		"	8.0-24	1400	82		
EV 1410		"	10-30	1300	82		
EV 2101		"	1.6-2.7	2100	1		
EV 2102		"	2.5-5.0	2100	1		
F6B	S	USA		300	47	19. Andrea (Chassis UF-6)	11-16
FBE-5324	A	"					
FL-55C	A	"					
FM-203	"	"					
FM-254	"	"					
FM-288	"	"					
FM-319	"	"					
FM-370	"	"					
FM-458	"	"					
G-30-50	A	USA				67. Dewald 666 (1940)	11-3
G46-A1	A	"	46	400	15	Majestic 400	3-42
G46-B1	A	"	46	300	15	Majestic 400 A	4-10
G-67B	"	"			6		
G-133	"	"					
GL-4A21 (4A21)	R	"	7.0-15	1600	22		
H20-60/60		Stab.	20-60	60	82		
H20-60/80		"	20-60	80	82		
H25-75/200		"	25-75	200	82		
H25-75/250		"	25-75	250	82		
H25-150/60		"	50-150	60	82		
H50-150/80		"	50-150	80	82		
H50-150/150		"	50-150	150	82		
H50-150/200		"	50-150	200	82		
H50-150/250		"	50-150	250	82		
H70-210/60		"	70-210	60	82		
H85-255/60		"	85-255	60	82		
H85-255/80		"	85-255	80	82		
H85-255/100		"	85-255	100	82		
H85-255/120		"	85-255	120	82		
H85-255/150		"	85-255	150	82		
H85-255/200		"	85-255	200	82		
H85-255/220		"	85-255	220	82		
H85-255/250		"	85-255	250	82		
H125-375/80		"	125-375	80	82		
H125-375/160		"	125-375	160	82		
H125-375/220		"	125-375	220	82		
H160-480/160		"	160-480	160	82		
H200-600/160		"	200-600	160	82		
H200-600/220		"	200-600	220	82		
H553	A	USA					
J-43B	"	"					
JFD A, B, or C	"	"	Universal Repl. Types			See Chart 6.	

Type	Use	Manuf.	Volt.	MA.	Base	Notes	Rider's Refer.
K6A	A	USA	6	300	28		
K6B	A	"	6	300	33		
K6BJ	A	"	6	300	42		
K6C	A	"	6	300	33		
K6CJ	A	"	6	300	42		
K6F	A	"	6	300	44		
K6S1	A	"	6	300	37		
K6S2	A	"	6	300	37		
K6S3	A	"	6	300	37		
K11A	A	"	11	300	28		
K11AJ	A	"	11	300	29		
K11B	A	"	11	300	33		
K11B2	A	"	11	300	41		
K11BJ	A	"	11	300	42		
K11C	A	"	11	300	33		
K11CJ	A	"	11	300	42		
K11D	A	"	11	300	36		
K11DJ	A	"	11	300	21		
K11E	A	"	11	300	43		
K11E1	A	"	11	300	33		
K11F	A	"	11	300	44		
K11G	A	"	11	300	44		
K11H	A	"	11	300	45		
K11J	A	"	11	300	46		
K11S1	A	"	11	300	37		
K11S2	A	"	11	300	37		
K11S3	A	"	11	300	37		
K13J36 (49A)	A	"	49	300	28	GE GD-60	10-3
K13J58	H	"				GE HE-740	13-63
K13J287	"	"				GE HE-740	13-63
K13J566	H	"	117	300	28		
K13J567	A	"		300		101. GE HE-540	12-66
K17A	A	"	17	300	28		
K17AJ	A	"	17	300	29		
K17B	A	"	17	300	33		
K17BJ	A	"	17	300	42		
K17C	A	"	17	300	33		
K17CJ	A	"	17	300	42		
K17D	A	"	17	300	36		
K17DJ	A	"	17	300	21		
K17E	A	"	17	300	43		
K17E1	A	"	17	300	33		
K17F	A	"	17	300	44		
K17H	A	"	17	300	45		
K17R	A	"	17	300		Midwest 8-38 (export)	8-30
K17S1	A	"	17	300	37		
K17S2	A	"	17	300	37		
K17S3	A	"	17	300	37		
K18A	A	"	18	300	28		
K18B	A	"	18	300	33	Freed 30-D	9-2
K18B2	A	"	18	300	41		
K18C	A	"	18	300	33		
K18D	A	"	18	300	36		
K18E	A	"	18	300	43		
K18E1	A	"	18	300	33		
K18F	A	"	18	300	44		
K18G	A	"	18	300	44		
K18H	A	"	18	300	45		
K18J	A	"	18	300	46		
K18R	A	"	18	300			
K22A	A	"	22	300	28		
K22B	A	"	22	300	33		
K22B2	A	"	22	300	41	Pilgrim GH	10-1
K22C	A	"	22	300	33		
K22D	A	"	22	300	36		
K22E	A	"	22	300	43		
K22E1	A	"	22	300	33		
K22F	A	"	22	300	44		
K22C	A	"	22	300	44		
K22H	A	"	22	300	45		
K22J	A	"	22	300	46		
K23A	A	"	23	300	28		
K23AJ	A	"	23	300	29		
K23B	A	"	23	300	33		
K23BJ	A	"	23	300	42		
K23C	A	"	23	300	33	Hetro F-21	7-3
K23CJ	A	"	23	300	42		

Type	Use	Manuf.	Volt.	MA.	Base	Notes	Rider's Refer.
K23D	A	USA	23	300	36		
K23DJ	A	"	23	300	21		
K23E	A	"	23	300	43		
K23E1	A	"	23	300	33		
K23F	A	"	23	300	44		
K23H	A	"	23	300	45		
K23S1	A	"	23	300	37		
K23S2	A	"	23	300	37		
K23S3	A	"	23	300	37		
K24B	A	"	24	300	33		
K24C	A	"	24	300	33		
K25B	A	"	25	300	33		
K26J218	A	"	26	300			
K26J307	H	"	See RB-790 and Note		102.		
K29A	A	"	29	300	28		
K30A	A	"	30	300	28		
K30AJ	A	"	30	300	29		
K30B	A	"	30	300	33		
K30B2	A	"	30	300	41		
K30BJ	A	"	30	300	42		
K30C	A	"	30	300	33		
K30CJ	A	"	30	300	42		
K30D	A	"	30	300	36		
K30DJ	A	"	30	300	21		
K30E	A	"	30	300	43		
K30E1	A	"	30	300	33		
K30E2	A	"	30	300	43		
K30F	A	"	30	300	44		
K30G	A	"	30	300	44		
K30H	A	"	30	300	45		
K30J	A	"	30	300	46		
K30S1	A	"	30	300	37		
K30S2	A	"	30	300	37		
K30S3	A	"	30	300	37		
K32D	A	"	32	300	36		
K33H	A	"	33	300	45		
K34A	A	"	34	300	28		
K34B	A	"	34	300	11/33	Freed 27-D	9-2
K34C	A	"	34	300	33		
K34D	A	"	34	300	36		
K34E	A	"	34	300	43		
K34E1	A	"	34	300	33		
K36A	A	"	36	300	28		
K36AJ	A	"	36	300	29		
K36B	A	"	36	300	33		
K36B2	A	"	36	300	41		
K36BJ	A	"	36	300	42		
K36C	A	"	36	300	33		
K36CJ	A	"	36	300	42		
K36D	A	"	36	300	36		
K36DJ	A	"	36	300	21		
K36E	A	"	36	300	43		
K36E1	A	"	36	300	33		
K36F	A	"	36	300	44		
K36G	A	"	36	300	44		
K36H (K36HA)	A	"	36	300	45		RCA 13-14
K36J	A	"	36	300	46		
K36S1	A	"	36	300	37		
K36S2	A	"	36	300	37		
K36S3	A	"	36	300	37		
K38A	A	"	38	300	28		
K38B	A	"	38	300	33		
K38B2	A	"	38	300	41	Pilgrim D	10-1
K38C	A	"	38	300	33		
K38D	A	"	38	300	36		
K38E	A	"	38	300	43		
K38E1	A	"	38	300	33		
K38F	A	"	38	300	44		
K38H	A	"	38	300	45		
K40B	A	"	40	300	33		
K40C	A	"	40	300	33		
K40D	A	"	40	300	36		
K40F	A	"	40	300	44		
K40I	A	"	40	300	11		
K40Y	A	"	40	300	11		
K42	A	"	42	300	26		
K42A	A	"	42	300	28	Espey WQXR	14-1

Type	Use	Manuf.	Volt.	MA.	Base	Notes	Rider's Refer.
K42AJ	A	USA	42	300	29		
K42B (K42B MG)	A	"	42	300	11/33		
K42B2	A	"	42	300	41		
K42B-K4	A	"	42	300	33		
K42BJ	A	"	42	300	42		
K42BJ-275	A	"	42	300	42		
K42C	A	"	42	300	11/33		
K42CS4	A	"					
K42CJ	A	"	42	300	42		
K42D	A	"	42	300	36		
K42DJ	A	"	42	300	21		
K42E	A	"	42	300	43	Bosch 620	7-27
K42E1	A	"	42	300	33		
K42F	A	"	42	300	44		
K42G	A	"	42	300	44		
K42H	A	"	42	300	45		
K42J	A	"	42	300	46		
K42S1	A	"	42	300	37		
K42S2	A	"	42	300	37		
K42S3	A	"	42	300	37		
K43A	A	"	43	300	28		
K43B	A	"	43	300	33		
K43B2	A	"	43	300	33		
K43F	A	"	43	300	44		
K43H	A	"	43	300	45		
K49	A	"	49	300	26	Espey WQXR	14-1
K49A	A	"	49	300	28		
K49AJ	A	"	49	300	29		
K49B	A	"	49	300	11/33		
K49B2	A	"	49	300	41		
K49BJ	A	"	49	300	42		
K49C	A	"	49	300	11/33	Allied E-10806	14-44
K49CB	A	"	49	300	33	Westinghouse WR 120	11-1
K49CJ	A	"	49	300	42		
K49D	A	"	49	300	36	Champion 5140-A	11-1
K49D-10	A	"	49	300	36		
K49DJ	A	"	49	300	21		
K49E	A	"	49	300	43		
K49E1	A	"	49	300	33		
K49F	A	"	49	300	44		
K49G	A	"	49	300	44		
K49H	A	"	49	300	45		
K49J	A	"	49	300	46		
K49S1	A	"	49	300	37		
K49S2	A	"	49	300	37		
K49S3	A	"	49	300	37		
K49X	A	"	49	300	11		
K49Y	A	"	49	300	11		
K50A	A	"	50	300	28		
K50B	A	"	50	300	33		
K50C	A	"	50	300	33		
K50H	A	"	50	300	45		
K52H	A	"	52	300	45		
K54B	A	"	54	300	33		
K55	A	"	55	300	31	20. Champion 54, 55	9-2
K55A	A	"	55	300	28		
K55AJ	A	"	55	300	29		
K55B	A	"	55	300	33	Trav-ler 521	8-1
K55B2	A	"	55	300	41		
K55BJ	A	"	55	300	42		
K55C	A	"	55	300	33	Bosch 604-B	8-7
K55CJ	A	"	55	300	42		
K55CP	A	"	55	300	38	Walgreen 255	9-1
K55CPR	A	"	55	300	38		
K55D	A	"	55	300	36		
K55DJ	A	"	55	300	21		
K55E	A	"	55	300	43		
K55E1	A	"	55	300	33		
K55F	A	"	55	300	44		
K55G	A	"	55	300	44		
K55H	A	"	55	300	45		
K55J	A	"	55	300	46		
K55S1	A	"	55	300	37		
K55S2	A	"	55	300	37		
K55S3	A	"	55	300	37		
K60L	A	"	60	300	33		

Type	Use	Manuf.	Volt.	MA.	Base	Notes	Rider's Refer.
K61A	A	USA	61	300	28	Emerson GL-457	14-6
K61AJ	A	"	61	300	29		
K61B	A	"	61	300	33		
K61BJ	A	"	61	300	42		
K61C	A	"	61	300	33		
K61CJ	A	"	61	300	42		
K61D	A	"	61	300	36	Champion Phono.	11-5
K61DJ	A	"	61	300	21		
K61E	A	"	61	300	43		
K61E1	A	"	61	300	33		
K61F	A	"	61	300	44		
K61H	A	"	61	300	45	RCA	13-14
K61S1	A	"	61	300	37		
K61S2	A	"	61	300	37		
K61S3	A	"	61	300	37		
K62B	A	"	62	300	33		
K67A	A	"	67	300	28		
K67AJ	A	"	67	300	29		
K67B	A	"	67	300	33		
K67B2	A	"	67	300	41		
K67BJ	A	"	67	300	42		
K67C	A	"	67	300	33		
K67CJ	A	"	67	300	42		
K67D	A	"	67	300	36		
K67DJ	A	"	67	300	21		
K67E	A	"	67	300	43		
K67E1	A	"	67	300	33		
K67F	A	"	67	300	44		
K67G	A	"	67	300	44		
K67H	A	"	67	300	45		
K67J	A	"	67	300	46		
K67S1	A	"	67	300	37		
K67S2	A	"	67	300	37		
K67S3	A	"	67	300	37		
K70A	A	"	70	300	28		
K70B	A	"	70	300	33		
K70C	A	"	70	300	33		
K70D	A	"	70	300	36		
K72A	A	"	72	300	28		
K72B	A	"	72	300	33	International KRC2	10-1
K72C	A	"	72	300	33		
K72D	A	"	72	300	36		
K73C	A	"	73	300	33		
K74A	A	"	74	300	28		
K74AJ	A	"	74	300	29		
K74B	A	"	74	300	33	Trav-ler 522	8-1
K74B2	A	"	74	300	41		
K74BJ	A	"	74	300	42		
K74C	A	"	74	300	33		
K74CJ	A	"	74	300	42		
K74D	A	"	74	300	36		
K74DJ	A	"	74	300	21		
K74E	A	"	74	300	43		
K74E1	A	"	74	300	33		
K74F	A	"	74	300	44		
K74G	A	"	74	300	44		
K74H	A	"	74	300	45		
K74J	A	"	74	300	46		
K74S1	A	"	74	300	37		
K74S2	A	"	74	300	37		
K74S3	A	"	74	300	37		
K75A	A	"	75	300	28		
K75B	A	"	75	300	33		
K75B2	A	"	75	300	41		
K75C	A	"	75	300	33		
K75CC	A	"	75	300	33		
K76B	A	"	76	300	33		
K76C	A	"	76	300	33		
K77-CC	A	"	77	300	33		
K78A	A	"	78	300	28		
K78B	A	"	78	300	11/33	Midwest 7-38	8-21
K78C	A	"	78	300	33		
K78D	A	"	78	300	36		
K78F	A	"	78	300	44		
K78H	A	"	78	300	45		

Type	Use	Manuf.	Volt.	MA.	Base	Notes	Rider's Refer.
K79A	A	USA	79	300	28		
K79B	A	"	79	300	11/33		
K79C	A	"	79	300	33		
K79D	A	"	79	300	36		
K80A	A	"	80	300	28		
K80AJ	A	"	80	300	29		
K80B	A	"	80	300	33		
K80BJ	A	"	80	300	42		
K80B2	A	"	80	300	41		
K80C	A	"	80	300	33		
K80CJ	A	"	80	300	42		
K80D	A	"	80	300	36		
K80DJ	A	"	80	300	21		
K80E	A	"	80	300	43		
K80E1	A	"	80	300	33		
K80F	A	"	80	300	44		
K80G	A	"	80	300	44		
K80H	A	"	80	300	45		
K80J	A	"	80	300	46		
K80S1	A	"	80	300	37		
K80S2	A	"	80	300	37		
K80S3	A	"	80	300	37		
K82A	A	"	82	300	28		
K82B	A	"	82	300	33		
K82C	A	"	82	300	33		
K82D	A	"	82	300	36		
K82F	A	"	82	300	44		
K82H	A	"	82	300	45		
K84H	A	"	84	300	45		
K86A	A	"	86	300	28		
K86AJ	A	"	86	300	29		
K86B	A	"	86	300	33		
K86BJ	A	"	86	300	42		
K86C	A	"	86	300	33	Champion 307	9-1
K86CJ	A	"	86	300	42		
K86D	A	"	86	300	36		
K86DJ	A	"	86	300	21		
K86E	A	"	86	300	43		
K86E1	A	"	86	300	33		
K86F	A	"	86	300	44		
K86H	A	"	86	300	45		
K86S1	A	"	86	300	37		
K86S2	A	"	86	300	37		
K86S3	A	"	86	300	37		
K87A	A	"	87	300	28		
K87B	A	"	87	300	33		
K87B2	A	"	87	300	41	Simplex 2-ZS	7-1
K87C	A	"	87	300	33		
K87D	A	"	87	300	36		
K87E	A	"	87	300	43		
K87E1	A	"	87	300	33		
K87F	A	"	87	300	44		
K87G	A	"	87	300	44		
K87H	A	"	87	300	45		
K87J	A	"	87	300	46		
K87S1	A	"	87	300	37		
K87S2	A	"	87	300	37		
K87S3	A	"	87	300	37		
K90A	A	"	90	300	28		
K90AJ	A	"	90	300	29		
K90B	A	"	90	300	33		
K90BJ	A	"	90	300	42		
K90C	A	"	90	300	33		
K90CJ	A	"	90	300	42		
K90D	A	"	90	300	36		
K90DJ	A	"	90	300	21		
K90F	A	"	90	300	44		
K90G	A	"	90	300	44	Mission Bell 498	11-3
K90H	A	"	90	300	45		
K92A	A	"	92	300	28		
K92B	A	"	92	300	33	Midwest 7-38	8-21
K92B2	A	"	92	300	41		
K92C	A	"	92	300	33		
K92D	A	"	92	300	36		
K92E	A	"	92	300	43		
K92E1	A	"	92	300	33		
K92F	A	"	92	300	44		

Type	Use	Manuf.	Volt.	MA.	Base	Notes	Rider's Refer.
K92G	A	USA	92	300	44		
K92H	A	"	92	300	45		
K92J	A	"	92	300	46		
K92S1	A	"	92	300	37		
K92S2	A	"	92	300	37		
K92S3	A	"	92	300	37		
K94A	A	"	94	300	28		
K94B	A	"	94	300	33		
K94C	A	"	94	300	33		
K94D	A	"	94	300	36		
K94F	A	"	94	300	44		
K94H	A	"	94	300	45		
K95A	A	"	95	300	28		
K95B	A	"	95	300	33		
K95B2	A	"	95	300	41		
K95C	A	"	95	300	33		
K95D	A	"	95	300	36		
K95F	A	"	95	300	44		
K95H	A	"	95	300	45		
K98A	A	"	98	300	28		
K98AJ	A	"	98	300	29		
K98B	A	"	98	300	33		
K98BJ	A	"	98	300	42		
K98C	A	"	98	300	33		
K98CJ	A	"	98	300	42		
K98D	A	"	98	300	36		
K98DJ	A	"	98	300	21		
K98E	A	"	98	300	43		
K98E1	A	"	98	300	33		
K98F	A	"	98	300	44		
K98H	A	"	98	300	45		
K98S1	A	"	98	300	37		
K98S2	A	"	98	300	37		
K98S3	A	"	98	300	37		
K99A	A	"	99	300	28		
K99B	A	"	99	300	33		
K99B2	A	"	99	300	41		
K99C	A	"	99	300	33		
K99D	A	"	99	300	36		
K99E	A	"	99	300	43		
K99E1	A	"	99	300	33		
K99F	A	"	99	300	44		
K99G	A	"	99	300	44		
K99H	A	"	99	300	45		
K99J	A	"	99	300	46		
K99S1	A	"	99	300	37		
K99S2	A	"	99	300	37		
K99S3	A	"	99	300	37		
K105A	A	"	105	300	28		
K105B	A	"	105	300	33		
K105C	A	"	105	300	33		
K105D	A	"	105	300	36		
K105S1	A	"	105	300	37		
K105S2	A	"	105	300	37		
K105S3	A	"	105	300	37		
K106A	A	"	106	300	28		
K106B	A	"	106	300	33		
K150A	H	"	150	300	28		
K 1336							
K-83747-1	A	"	42	300	33	Westinghouse WR-42X2	14-8
K-83747-2							
K-83747-3	A	"	42	300	42	88. RCA 5Q8	11-19
K-83747-4	H	"	152	300	49	RCA 5Q8	11-19
K-83747-5							
K-83747-6	A	"			34	122. RCA	13-14
K-85277-3	H	"				85. RCA 5Q2X	11-11
K-85277-4	H	"			49	86. RCA 5Q8	11-19
K-85277-5	H	"				87. RCA 5Q6	11-17
K-920117-1	H	"				137. RCA RC-1004E	15-25
K-920146-1						RCA	13-14
KL-25	A	USA		Universal Repl. Type		See Chart 4.	
KL-25R	A	"		"		"	
KL-25H	A	"		"		"	
KL-25J	A	"		"		"	
KL-45	A	"		"		"	
KL-45J	A	"		"		"	

Type	Use	Manuf.	Volt.	MA.	Base	Notes	Rider's Refer.
KL-50E	A	USA	Universal	Repl.	Type	See Chart 4.	
KL-50H	A	"	"	"	"	" " "	
KL-50J	A	"	"	"	"	" " "	
KL-50S1	A	"	"	"	"	" " "	
KL-50S2	A	"	"	"	"	" " "	
KL-50S3	A	"	"	"	"	" " "	
KL-75	A	"	"	"	"	" " "	
KL-75H	A	"	"	"	"	" " "	
KL-75J	A	"	"	"	"	" " "	
KL-220	H	"	"	"	"	" " "	
KS-1320		Oesram	25-50	200	72		
KS-3747-6		USA					
KX23A	A	"	23	300	6		
KX23B	A	"	23	300	11		
KX23C	A	"	23	300	11		
KX23D	A	"	23	300	12		
KX23 R	A	"	23	300	6		
KX27A	A	"	27	300	6		
KX30A	A	"	30	300	6		
KX30B	A	"	30	300	11		
KX30C	A	"	30	300	11		
KX30D	A	"	30	300	12		
KX36A	A	"	36	300	6		
KX36B	A	"	36	300	11		
KX36C	A	"	36	300	11		
KX36D	A	"	36	300	12		
KX42A	A	"	42	300	6		
KX42B	A	"	42	300	11		
KX42C	A	"	42	300	11		
KX42D	A	"	42	300	12		
KX45A	A	"	45	300	6		
KX46A	A	"	46	300	6		
KX49A	A	"	49	300	6		
KX49B	A	"	49	300	11		
KX49C	A	"	49	300	11		
KX49D	A	"	49	300	12		
KX55A	A	"	55	300	6		
KX55B	A	"	55	300	11		
KX55C	A	"	55	300	11		
KX55D	A	"	55	300	12		
KX61A	A	"	61	300	6		
KX61B	A	"	61	300	11		
KX61C	A	"	61	300	11		
KX61D	A	"	61	300	12		
KX67A	A	"	67	300	6		
KX67B	A	"	67	300	11		
KX67C	A	"	67	300	11		
KX67D	A	"	67	300	12		
KX74A	A	"	74	300	6		
KX74B	A	"	74	300	11		
KX74C	A	"	74	300	11		
KX74D	A	"	74	300	12		
KX78B	A	"	78	300	11		
KX80A	A	"	80	300	6		
KX80B	A	"	80	300	11		
KX80C	A	"	80	300	11		
KX80D	A	"	80	300	12		
KX86A	A	"	86	300	6		
KX86B	A	"	86	300	11		
KX86C	A	"	86	300	11		
KX86D	A	"	86	300	12		
KX92A	A	"	92	300	6		
KX92B	A	"	92	300	11		
KX92C	A	"	92	300	11		
KX92D	A	"	92	300	12		
KX98A	A	"	98	300	6		
KX98B	A	"	98	300	11		
KX98C	A	"	98	300	11		
KX98D	A	"	98	300	12		
KX105A	A	"	105	300	6		
KX105B	A	"	105	300	11		
KX105C	A	"	105	300	11		
KX105D	A	"	105	300	12		

Type	Use	Manuf.	Volt.	MA.	Base	Notes	Rider's Refer.
KY6B	A	USA	6	300	40		
KY6C	A	"	6	300	40		
KY6D	A	"	6	300	41		
KY11A	A	"	11	300	39		
KY11B	A	"	11	300	40		
KY11C	A	"	11	300	40		
KY11D	A	"	11	300	41		
KY17A	A	"	17	300	39		
KY17B	A	"	17	300	40		
KY17C	A	"	17	300	40		
KY17D	A	"	17	300	41		
KY23A	A	"	23	300	39		
KY23B	A	"	23	300	40		
KY23C	A	"	23	300	40		
KY23D	A	"	23	300	41		
KY30A	A	"	30	300	39		
KY30B	A	"	30	300	40		
KY30C	A	"	30	300	40		
KY30D	A	"	30	300	41		
KY36A	A	"	36	300	39		
KY36B	A	"	36	300	40		
KY36C	A	"	36	300	40		
KY36D	A	"	36	300	41		
KY42A	A	"	42	300	39		
KY42B	A	"	42	300	40		
KY42C	A	"	42	300	40		
KY42D	A	"	42	300	41		
KY49A	A	"	49	300	39		
KY49B	A	"	49	300	40		
KY49C	A	"	49	300	40		
KY49D	A	"	49	300	41		
KY55A	A	"	55	300	39		
KY55B	A	"	55	300	40		
KY55C	A	"	55	300	40		
KY55D	A	"	55	300	41		
KY61A	A	"	61	300	39		
KY61B	A	"	61	300	40		
KY61C	A	"	61	300	40		
KY61D	A	"	61	300	41		
KY67A	A	"	67	300	39		
KY67B	A	"	67	300	40		
KY67C	A	"	67	300	40		
KY67D	A	"	67	300	41		
KY74A	A	"	74	300	39		
KY74B	A	"	74	300	40		
KY74C	A	"	74	300	40		
KY74D	A	"	74	300	41		
KY80A	A	"	80	300	39		
KY80B	A	"	80	300	40		
KY80C	A	"	80	300	40		
KY80D	A	"	80	300	41		
KY86A	A	"	86	300	39		
KY86B	A	"	86	300	40		
KY86C	A	"	86	300	40		
KY86D	A	"	86	300	41		
KY90A	A	"	90	300	39		
KY90B	A	"	90	300	40		
KY90C	A	"	90	300	40		
KY90D	A	"	90	300	41		
KY92C	A	"	92	300	40		
KY98A	A	"	98	300	39		
KZ6B	A	"	6	300	24		
KZ6C	A	"	6	300	24		
KZ11B	A	"	11	300	24		
KZ11C	A	"	11	300	24		
KZ17A	A	"	17	300	22		
KZ17B	A	"	17	300	24		
KZ17C	A	"	17	300	24		
KZ23B	A	"	23	300	24		
KZ23C	A	"	23	300	24		
KZ30B	A	"	30	300	24		
KZ30C	A	"	30	300	24		
KZ36B	A	"	36	300	24		
KZ36C	A	"	36	300	24		
KZ42B	A	"	42	300	24		
KZ42C	A	"	42	300	24		

Type	Use	Manuf.	Volt.	MA.	Base	Notes	Rider's Refer.
KZ49A	A	USA	49	300	22		
KZ49B	A	"	49	300	24		
KZ49C	A	"	49	300	24		
KZ55A	A	"	55	300	22		
KZ55B	A	"	55	300	24		
KZ55C	A	"	55	300	24		
KZ61B	A	"	61	300	24		
KZ61C	A	"	61	300	24		
KZ67B	A	"	67	300	24		
KZ67C	A	"	67	300	24		
KZ68	A	"	68	300			
KZ74A	A	"	74	300	22		
KZ74B	A	"	74	300	24		
KZ74C	A	"	74	300	24		
KZ80A	A	"	80	300	22		
KZ80B	A	"	80	300	24		
KZ80C	A	"	80	300	24		
KZ86A	A	"	86	300	22		
KZ86B	A	"	86	300	24		
KZ86C	A	"	86	300	24		
KZ92A	A	"	92	300	22		
KZ92B	A	"	92	300	24		
KZ92C	A	"	92	300	24		
KZ98B	A	"	98	300	24		
KZ98C	A	"	98	300	24		
KZ105A	A	"	105	300	22		
KZ105B	A	"	105	300	24		
KZ105C	A	"	105	300	24		
L6A	A	USA	6	300	28		
L6B	A	"	6	300	33		
L6BJ	A	"	6	300	42		
L6C	A	"	6	300	33		
L6CJ	A	"	6	300	42		
L6F	A	"	6	300	44		
L6S1	A	"	6	300	37		
L6S2	A	"	6	300	37		
L10C	A	"	10	300	33	Spiegel 4010	10-37
L11A	A	"	11	300	28		
L11AJ	A	"	11	300	29		
L11B	A	"	11	300	33		
L11B2	A	"	11	300	41		
L11BJ	A	"	11	300	42		
L11C	A	"	11	300	33		
L11CJ	A	"	11	300	42		
L11D	A	"	11	300	36		
L11DJ	A	"	11	300	21		
L11E	A	"	11	300	43		
L11E1	A	"	11	300	33		
L11F	A	"	11	300	44		
L11G	A	"	11	300	44		
L11H	A	"	11	300	45		
L11J	A	"	11	300	46		
L11S1	A	"	11	300	37		
L11S2	A	"	11	300	37		
L11S3	A	"	11	300	37		
L15B	A	"	15	300	33	Halson 30	9-4
L15C	A	"	15	300	33		
L15D	A	"	15	300	36		
L17A	A	"	17	300	28		
L17AJ	A	"	17	300	29		
L17B	A	"	17	300	33		
L17BJ	A	"	17	300	42		
L17C	A	"	17	300	33		
L17CJ	A	"	17	300	42		
L17D	A	"	17	300	36		
L17DJ	A	"	17	300	21		
L17E	A	"	17	300	43		
L17E1	A	"	17	300	33		
L17F	A	"	17	300	44		
L17H	A	"	17	300	45		
L17S1	A	"	17	300	37		
L17S2	A	"	17	300	37		
L17S3	A	"	17	300	37		
L18A	A	"	18	300	28		
L18B	A	"	18	300	33		

Type	Use	Manuf.	Volt.	MA.	Base	Notes	Rider's Refer.
L18B2	A	USA	18	300	41		
L18C	A	"	18	300	33		
L18D	A	"	18	300	36		
L18E	A	"	18	300	43		
L18E1	A	"	18	300	33		
L18F	A	"	18	300	44		
L18G	A	"	18	300	44		
L18H	A	"	18	300	45		
L18J	A	"	18	300	46		
L22A	A	"	22	300	28		
L22B	A	"	22	300	33		
L22B2	A	"	22	300	41		
L22C	A	"	22	300	33		
L22D	A	"	22	300	36		
L22E	A	"	22	300	43		
L22E1	A	"	22	300	33		
L22F	A	"	22	300	44		
L22G	A	"	22	300	44		
L22H	A	"	22	300	45		
L22J	A	"	22	300	46		
L23A	A	"	23	300	28		
L23AJ	A	"	23	300	29		
L23B	A	"	23	300	33		
L23BJ	A	"	23	300	42		
L23C	A	"	23	300	33		
L23CJ	A	"	23	300	42		
L23D	A	"	23	300	36		
L23DJ	A	"	23	300	21		
L23E	A	"	23	300	43		
L23E1	A	"	23	300	33		
L23F	A	"	23	300	44		
L23H	A	"	23	300	45		
L23S1	A	"	23	300	37		
L23S2	A	"	23	300	37		
L23S3	A	"	23	300	37		
L24B	A	"	24	300	33		
L24C	A	"	24	300	33		
L25C	A	"	25	300	44	GE GDS-73	12-38
L26B	A	"	26	300	33		
L-26CC	A	"	26	300	33		
L-26CC-159	A	"	26	300	33		
L30A	A	"	30	300	28		
L30AJ	A	"	30	300	29		
L30B	A	"	30	300	33		
L30B2	A	"	30	300	41		
L30BJ	A	"	30	300	42		
L30C	A	"	30	300	33		
L30CC	A	"	30	300	33		
L30CJ	A	"	30	300	42		
L30D	A	"	30	300	36		
L30DJ	A	"	30	300	21		
L30E	A	"	30	300	43		
L30E1	A	"	30	300	33		
L30F	A	"	30	300	44		
L30G	A	"	30	300	44		
L30H	A	"	30	300	26		
L30J	A	"	30	300	46		
L30S1	A	"	30	300	37		
L30S2	A	"	30	300	37		
L30S3	A	"	30	300	37		
L32B	A	"	32	300	33		
L32C	A	"	32	300	33		
L34B	A	"	34	300	33		
L34C	A	"	34	300	33		
L34D	A	"	34	300	36		
L34E	A	"	34	300	43		
L35-5.5C	A	"	34	300			
L36A	A	"	36	300	28		
L36AJ	A	"	36	300	29		
L36B	A	"	36	300	11/33		
L36B2	A	"	36	300	41		
L36BJ	A	"	36	300	42		
L36C	A	"	36	300	33		
L36CJ	A	"	36	300	42		
L36D	A	"	36	300	36		
L36DJ	A	"	36	300	21	Garod C118	13-6
L36E	A	"	36	300	43		

Type	Use	Manuf.	Volt.	MA.	Base	Notes	Rider's Refer.
L36E1	A	USA	36	300	33		
L36F	A	"	36	300	44		
L36G	A	"	36	300	44		
L36H	A	"	36	300	45		
L36J	A	"	36	300	46		
L36S1	A	"	36	300	37		
L36S2	A	"	36	300	37		
L36S3	A	"	36	300	37		
L38B	A	"	38	300	33		
L38C	A	"	38	300	33		
L38D	A	"	38	300	36		
L39B	A	"	39	300	33		
L39C	A	"	39	300	33		
L39D	A	"	39	300	36		
L39DJ	A	"	39	300	21		
L40B	A	"	40	300	33		
L40C	A	"	40	300	33	Allied B10510	13-2
L40CT	A	"	40	300	33		
L40D	A	"	40	300	36		
L40E	A	"	40	300	43		
L40E1	A	"	40	300	33		
L40F	A	"	40	300	44		
L40S	A	"	40	300	33#	Pacific 6322	7-7
L40S1	A	"	40	300	37		
L40S2	A	"	40	300	37		
L40S3	A	"	40	300	37		
L42A	A	"	42	300	28		
L42AJ	A	"	42	300	29		
L42B	A	"	42	300	11/33	Emerson DP-332	11-32
L42B2	A	"	42	300	40		
L42BJ	A	"	42	300	42		
L42BX	A	"	42	300	33#		
L42C	A	"	42	300	11/33	Climax U, UE	9-2
L42CJ	A	"	42	300	42		
L42CS4	A	"	42	300			
L42D	A	"	42	300	12/36		
L42DJ	A	"	42	300	21		
L42DSX	A	"	42	300			
L42DX	A	"	42	300			
L42E	A	"	42	300	43	MarconiPhone 1937	10-1
L42E1	A	"	42	300	33		
L42F	A	"	42	300	44	Dewald 637	9-3
L42G	A	"	42	300	44		
L42H	A	"	42	300	45		
L42J	A	"	42	300	46		
L42S1	A	"	42	300	37		
L42S2	A	"	42	300	37		
L42S3	A	"	42	300	37		
L48B	A	"	48	300	33		
L48C	A	"	48	300	33		
L48D	A	"	48	300	36		
L49-5.5C	A	"	49	300	33		
L49-5.5E	A	"	49	300	43		
L49A	A	"	49	300	28		
L49AJ	A	"	49	300	29		
L49B	A	"	49	300	11/33	Emerson DM-331	11-31
L49B2	A	"	49	300	41		
L49BJ	A	"	49	300	42	Continental 6Y	8-8
L49BSX	A	"	49	300			
L49BX	A	"	49	300			
L49C	A	"	49	300	11/33	Dewald 621	7-8
L49CJ	A	"	49	300	42		
L49D	A	"	49	300	12/36	Emerson CG-293	11-19,20
L49DJ	A	"	49	300	21	Carod 739	10-18
L49DSX	A	"	49	300			
L49DX	A	"	49	300			
L49E	A	"	49	300	43	24. Freed FE-62	8-3
L49E1	A	"	49	300	33		
L49F	A	"	49	300	44	Dewald 701	9-7
L49G	A	"	49	300	44		
L49H	A	"	49	300	45		
L49J	A	"	49	300	46		
L49S1	A	"	49	300	37		
L49S2	A	"	49	300	37		
L49S3	A	"	49	300	37		

Type	Uma	Manuf.	Volt.	MA.	Base	Notes	Rider's Refer.
L54B	A	USA	54	300	33		
L54C	A	"	54	300	33		
L54D	A	"	54	300	36		
L55-5C	A	"	55	300	33		
L55-5.5C	A	"	55	300	33		
L55-5.5E	A	"	55	300	43		
L55A	A	"	55	300	28		
L55AJ	A	"	55	300	29		
L55B	A	"	55	300	11/33	Allied A-9740	9-1
L55B2	A	"	55	300	41		
L55BJ	A	"	55	300	42		
L55C	A	"	55	300	11/33	Climax E-02	9-1
L55CJ	A	"	55	300	42		
L55CP	A	"	55	300	38		
L55CPR	A	"	55	300	38		
L55D	A	"	55	300	36		
L55DJ	A	"	55	300	21		
L55E	A	"	55	300	43		
L55E1	A	"	55	300	33		
L55F	A	"	55	300	44	GE GD-41	9-6
L55G	A	"	55	300	44		
L55H	A	"	55	300	45		
L55J	A	"	55	300	46		
L55S1	A	"	55	300	37	Lafayette AS-5	9-3
L55S2	A	"	55	300	37	Ronald 50, 56, 59	7-13
L55S3	A	"	55	300	37	CLINOR	
L59BJ	A	"	59	300	42		
L60B	A	"	60	300	33		
L61A	A	"	61	300	28		
L61AJ	A	"	61	300	29		
L61B	A	"	61	300	33		
L61BJ	A	"	61	300	42		
L61C	A	"	61	300	33		
L61CJ	A	"	61	300	42		
L61D	A	"	61	300	36		
L61DJ	A	"	61	300	21		
L61E	A	"	61	300	43		
L61E1	A	"	61	300	33		
L61F	A	"	61	300	44		
L61G	A	"	61	300	44		
L61H	A	"	61	300	45		
L61S1	A	"	61	300	37		
L61S2	A	"	61	300	37		
L61S3	A	"	61	300	37		
L66B	A	"	66	300	33		
L67A	A	USA	67	300	28		
L67AJ	A	"	67	300	29		
L67B	A	"	67	300	33		
L67B2	A	"	67	300	41		
L67BJ	A	"	67	300	42		
L67C	A	"	67	300	33		
L67CJ	A	"	67	300	42		
L67D	A	"	67	300	36	Emerson FM-460	14-7,8
L67DJ	A	"	67	300	21		
L67E	A	"	67	300	43		
L67E1	A	"	67	300	33		
L67F	A	"	67	300	44		
L67G	A	"	67	300	44		
L67H	A	"	67	300	45		
L67J	A	"	67	300	46		
L67S1	A	"	67	300	37		
L67S2	A	"	67	300	37		
L67S3	A	"	67	300	37		
L70B	A	"	70	300	33		
L70C	A	"	70	300	33		
L70D	A	"	70	300	36		
L72B	A	"	72	300	33		
L72C	A	"	72	300	33		
L72D	A	"	72	300	36		
L73B	A	"	73	300	33	Climax ATE	9-1
L74A	A	"	74	300	28		
L74AJ	A	"	74	300	29		
L74B	A	"	74	300	33		
L74B2	A	"	74	300	41		
L74BJ	A	"	74	300	42		

Type	Use	Manuf.	Volt.	MA.	Base	Notes	Rider's Refer.
L74C	A	USA	74	300	33		
L74CC	A	"	74	300	33		
L74CJ	A	"	74	300	42		
L74D	A	"	74	300	36		
L74DJ	A	"	74	300	21		
L74E	A	"	74	300	43		
L74E1	A	"	74	300	33		
L74F	A	"	74	300	44		
L74G	A	"	74	300	44		
L74H	A	"	74	300	45		
L74J	A	"	74	300	46		
L74S1	A	"	74	300	37		
L74S2	A	"	74	300	37		
L74S3	A	"	74	300	37		
L75CC	A	"	75	300	36	Halsen 1900	9-9
L80A	A	"	80	300	28		
L80AJ	A	"	80	300	29		
L80B	A	"	80	300	33	Climax ATE	9-1
L80B2	A	"	80	300	41		
L80BJ	A	"	80	300	42		
L80C	A	"	80	300	33		
L80CJ	A	"	80	300	42		
L80D	A	"	80	300	36		
L80DJ	A	"	80	300	21		
L80E	A	"	80	300	43		
L80E1	A	"	80	300	33		
L80F	A	"	80	300	44		
L80G	A	"	80	300	44		
L80H	A	"	80	300	45		
L80J	A	"	80	300	46		
L80S1	A	"	80	300	37		
L81B	A	"	81	300	33		
L81BJ	A	"	81	300	42		
L85CC	A	"	85	300	36	Halsen 1200	9-10
L86A	A	"	86	300	28		
L86AJ	A	"	86	300	29		
L86B	A	"	86	300	33		
L86BJ	A	"	86	300	42		
L86C	A	"	86	300	33		
L86CJ	A	"	86	300	42		
L86D	A	"	86	300	36		
L86DJ	A	"	86	300	21		
L86E	A	"	86	300	43		
L86E1	A	"	86	300	33		
L86F	A	"	86	300	44		
L86H	A	"	86	300	45		
L86S1	A	"	86	300	37		
L86S2	A	"	86	300	37		
L86S3	A	"	86	300	37		
L87A	A	"	87	300	28		
L87B	A	"	87	300	33		
L87C	A	"	87	300	33		
L87D	A	"	87	300	36		
L87E	A	"	87	300	43		
L87F	A	"	87	300	44		
L87G	A	"	87	300	44		
L87H	A	"	87	300	45		
L87J	A	"	87	300	46		
L90A	A	"	90	300	28		
L90AJ	A	"	90	300	29		
L90B	A	"	90	300	33		
L90BJ	A	"	90	300	42		
L90C	A	"	90	300	33		
L90CC	A	"	90	300	33		
L90CJ	A	"	90	300	42		
L90D	A	"	90	300	36		
L90DJ	A	"	90	300	21		
L90F	A	"	90	300	44		
L90H	A	"	90	300	45		
L90S1	A	"	90	300	37		
L90S2	A	"	90	300	37		
L90S3	A	"	90	300	37		
L91D	A	"	91	300	36		
L92A	A	"	92	300	28		
L92B	A	"	92	300	33		
L92C	A	"	92	300	33		
L92D	A	"	92	300	36		

Type	Use	Manuf.	Volt.	MA.	Base	Notes	Rider's Refer.
L92E	A	USA	92	300	43		
L92E1	A	"	92	300	33		
L92F	A	"	92	300	44		
L92G	A	"	92	300	44		
L92H	A	"	92	300	45		
L92J	A	"	92	300	46		
L92S1	A	"	92	300	37		
L92S2	A	"	92	300	37		
L92S3	A	"	92	300	37		
L98A	A	"	98	300	28		
L98AJ	A	"	98	300	29		
L98B	A	"	98	300	33		
L98BJ	A	"	98	300	42		
L98C	A	"	98	300	33		
L98CJ	A	"	98	300	42		
L98D	A	"	98	300	36		
L98E	A	"	98	300	43		
L98E1	A	"	98	300	33		
L98F	A	"	98	300	44		
L98H	A	"	98	300	45		
L98S1	A	"	98	300	37		
L98S2	A	"	98	300	37		
L98S3	A	"	98	300	37		
L99D	A	"	99	300	36		
L100D	A	"	100	300	36		
L105A	A	"	105	300	28		
L105B	A	"	105	300	33		
L105C	A	"	105	300	33		
L105S1	A	"	105	300	37		
L105S2	A	"	105	300	37		
L105S3	A	"	105	300	37		
L120-75CC		"					
L122B	H	"	122	300	33		
L134A	H	"	134	300	28	GE GDR-73	12-38
L150B	H	"	150	300	33		
L159B	H	"	159	300	33		
L555+50							
LH-1	B	"	0.3-1.2	180	6		
LK 200		German	2.0-3.5	5000	57		
LK 302		"	3.0-9.0	5000	65		
LL-25	B	USA	1.0	590	6	Emerson 103	6-8
LL-225	B	"	1.0	500	6		
LR-1	B	"	1.0	560	22	Equiv. to 1T1C	
LX23A	A	USA	23	300	6		
LX23B	A	"	23	300	11		
LX23C	A	"	23	300	11		
LX23D	A	"	23	300	12		
LX30A	A	"	30	300	6		
LX30B	A	"	30	300	11		
LX30C	A	"	30	300	11		
LX30D	A	"	30	300	12		
LX36A	A	"	36	300	6		
LX36B	A	"	36	300	11		
LX36C	A	"	36	300	11		
LX36D	A	"	36	300	12		
LX42B	A	"	42	300	11		
LX42C	A	"	42	300	11		
LX42D	A	"	42	300	12		
LX49A	A	"	49	300	6		
LX49B	A	"	49	300	11		
LX49C	A	"	49	300	11		
LX49D	A	"	49	300	12		
LX55B	A	"	55	300	11		
LX55C	A	"	55	300	11		
LX55D	A	"	55	300	12		
LX61A	A	"	61	300	6		
LX61B	A	"	61	300	11		
LX61C	A	"	61	300	11		
LX61D	A	"	61	300	12		
LX67A	A	"	67	300	6		
LX67B	A	"	67	300	11		
LX67C	A	"	67	300	11		
LX67D	A	"	67	300	12		
LX74A	A	"	74	300	6		
LX74B	A	"	74	300	11		
LX74C	A	"	74	300	11		

Type	Use	Manuf.	Volt.	MA.	Base	Notes	Rider's Refer.
LX74D	A	USA	74	300	12		
LX80B	A	"	80	300	11		
LX80C	A	"	80	300	11		
LX80D	A	"	80	300	12		
LX86B	A	"	86	300	11		
LX86C	A	"	86	300	11		
LX86D	A	"	86	300	12		
LX92B	A	"	92	300	11		
LX92C	A	"	92	300	11		
LX92D	A	"	92	300	12		
LX98A	A	"	98	300	6		
LX98B	A	"	98	300	11		
LX98C	A	"	98	300	11		
LX98D	A	"	98	300	12		
LX105B	A	"	105	300	11		
LX105C	A	"	105	300	11		
LX105D	A	"	105	300	12		
LY6B	A	USA	6	300	40		
LY6C	A	"	6	300	40		
LY6D	A	"	6	300	41		
LY11A	A	"	11	300	39		
LY11B	A	"	11	300	40		
LY11C	A	"	11	300	40		
LY11D	A	"	11	300	41		
LY17A	A	"	17	300	39		
LY17B	A	"	17	300	40		
LY17C	A	"	17	300	40		
LY17D	A	"	17	300	41		
LY23A	A	"	23	300	39		
LY23B	A	"	23	300	40		
LY23C	A	"	23	300	40		
LY23D	A	"	23	300	41		
LY30A	A	"	30	300	39		
LY30B	A	"	30	300	40		
LY30C	A	"	30	300	40		
LY30D	A	"	30	300	41		
LY36A	A	"	36	300	39		
LY36B	A	"	36	300	40		
LY36C	A	"	36	300	40		
LY36D	A	"	36	300	41		
LY42A	A	"	42	300	39		
LY42B	A	"	42	300	40		
LY42C	A	"	42	300	40		
LY42D	A	"	42	300	41		
LY49A	A	"	49	300	39		
LY49B	A	"	49	300	40		
LY49C	A	"	49	300	40		
LY49D	A	"	49	300	41		
LY55A	A	"	55	300	39		
LY55B	A	"	55	300	40		
LY55C	A	"	55	300	40		
LY55D	A	"	55	300	41		
LY61A	A	"	61	300	39		
LY61B	A	"	61	300	40		
LY61C	A	"	61	300	40		
LY61D	A	"	61	300	41		
LY67A	A	"	67	300	39		
LY67B	A	"	67	300	40		
LY67C	A	"	67	300	40		
LY67D	A	"	67	300	41		
LY74A	A	"	74	300	39		
LY74B	A	"	74	300	40		
LY74C	A	"	74	300	40		
LY74D	A	"	74	300	41		
LY80A	A	"	80	300	39		
LY80B	A	"	80	300	40		
LY80C	A	"	80	300	40		
LY80D	A	"	80	300	41		
LY86A	A	"	86	300	39		
LY86B	A	"	86	300	40		
LY86C	A	"	86	300	40		
LY86D	A	"	86	300	41		
LY90A	A	"	90	300	39		
LY90B	A	"	90	300	40		
LY90C	A	"	90	300	40		
LY90D	A	"	90	300	41		

Type	Use	Manuf.	Volt.	MA.	Base	Notes	Rider's Refer.
LY98A	A	USA	98	300	39		
LY98B	A	"	98	300	40		
LY98C	A	"	98	300	40		
LY98D	A	"	98	300	41		
L26B	A	USA	6	300	24		
L26C	A	"	6	300	24		
L211B	A	"	11	300	24		
L211C	A	"	11	300	24		
L217A	A	"	17	300	22		
L217B	A	"	17	300	24		
L217C	A	"	17	300	24		
L223B	A	"	23	300	24		
L223C	A	"	23	300	24		
L230B	A	"	30	300	24		
L230C	A	"	30	300	24		
L236B	A	"	36	300	24		
L236C	A	"	36	300	24		
L242B	A	"	42	300	24		
L242C	A	"	42	300	24		
L249B	A	"	49	300	24		
L249C	A	"	49	300	24		
L255A	A	"	55	300	22		
L255B	A	"	55	300	24		
L255C	A	"	55	300	24		
L261B	A	"	61	300	24		
L261C	A	"	61	300	24		
L267B	A	"	67	300	24		
L267C	A	"	67	300	24		
L274A	A	"	74	300	22		
L274B	A	"	74	300	24		
L274C	A	"	74	300	24		
L280A	A	"	80	300	22		
L280B	A	"	80	300	24		
L280C	A	"	80	300	24		
L286A	A	"	86	300	22		
L286B	A	"	86	300	24		
L286C	A	"	86	300	24		
L292A	A	"	92	300	22		
L292B	A	"	92	300	24		
L292C	A	"	92	300	24		
L298B	A	"	98	300	24		
L298C	A	"	98	300	24		
L2105B	A	"	105	300	24		
L2105C	A	"	105	300	24		
M6A	A	USA	6	300	28		
M6B	A	"	6	300	33		
M6BJ	A	"	6	300	42		
M6C	A	"	6	300	33		
M6CJ	A	"	6	300	42		
M6F	A	"	6	300	44		
M6S1	A	"	6	300	37		
M6S2	A	"	6	300	37		
M11A	A	"	11	300	28		
M11AJ	A	"	11	300	29		
M11B	A	"	11	300	33		
M11BJ	A	"	11	300	42		
M11C	A	"	11	300	33		
M11CJ	A	"	11	300	42		
M11D	A	"	11	300	36		
M11DJ	A	"	11	300	21		
M11E	A	"	11	300	43		
M11E1	A	"	11	300	33		
M11F	A	"	11	300	44		
M11H	A	"	11	300	45		
M11S1	A	"	11	300	37		
M11S2	A	"	11	300	37		
M11S3	A	"	11	300	37		
M17A	A	"	17	300	28		
M17AJ	A	"	17	300	29		
M17B	A	"	17	300	33		
M17BJ	A	"	17	300	42		
M17C	A	"	17	300	33		
M17CJ	A	"	17	300	42		
M17D	A	"	17	300	36		
M17DJ	A	"	17	300	21		

Type	Use	Manuf.	Volt.	MA.	Base	Notes	Rider's Refer.
M17E	A	USA	17	300	43		
M17E1	A	"	17	300	33		
M17F	A	"	17	300	44		
M17H	A	"	17	300	45		
M17S1	A	"	17	300	37		
M17S2	A	"	17	300	37		
M17S3	A	"	17	300	37		
M22H	A	"	22	300	45	Sears 7226	10-112
M23A	A	"	23	300	28		
M23AJ	A	"	23	300	29		
M23B	A	"	23	300	33		
M23BJ	A	"	23	300	42		
M23C	A	"	23	300	33		
M23CJ	A	"	23	300	42		
M23D	A	"	23	300	36		
M23DJ	A	"	23	300	21		
M23E	A	"	23	300	43		
M23E1	A	"	23	300	33		
M23F	A	"	23	300	44		
M23H	A	"	23	300	45		
M23S1	A	"	23	300	37		
M23S2	A	"	23	300	37		
M23S3	A	"	23	300	37		
M27F	A	"	27	300	44		
M27H	A	"	27	300	45		
M30A	A	"	30	300	28		
M30AJ	A	"	30	300	29		
M30B	A	"	30	300	33		
M30BJ	A	"	30	300	42		
M30C	A	"	30	300	33		
M30CJ	A	"	30	300	42		
M30D	A	"	30	300	36		
M30DJ	A	"	30	300	21		
M30E	A	"	30	300	43		
M30E1	A	"	30	300	33		
M30F	A	"	30	300	44		
M30H	A	"	30	300	45	Air King 701	9-7
M30S1	A	"	30	300	37		
M30S2	A	"	30	300	37		
M30S3	A	"	30	300	37		
M32B	A	"	32	300	33		
M32C	A	"	32	300	33		
M32D	A	"	32	300	36		
M32F	A	"	32	300	44		
M32H	A	"	32	300	45		
M33B	A	"	33	300	33		
M33C	A	"	33	300	33		
M33D	A	"	33	300	36		
M33H	A	"	33	300	45		
M34B	A	"	34	300	33		
M34C	A	"	34	300	33		
M34D	A	"	34	300	36		
M36A	A	"	36	300	28		
M36AJ	A	"	36	300	29		
M36B	A	"	36	300	33		
M36BJ	A	"	36	300	42		
M36C	A	"	36	300	33		
M36CJ	A	"	36	300	42		
M36D	A	"	36	300	36		
M36DJ	A	"	36	300	21		
M36E	A	"	36	300	43		
M36E1	A	"	36	300	33		
M36F	A	"	36	300	44		
M36H	A	"	36	300	45	Air King 824	9-13
M36S1	A	"	36	300	37		
M36S2	A	"	36	300	37		
M36S3	A	"	36	300	37		
M38B	A	"	38	300	33		
M38C	A	"	38	300	33		
M38D	A	"	38	300	36		
M38E	A	"	38	300	43		
M38S1	A	"	38	300	33		
M38F	A	"	38	300	44		
M38H	A	"	38	300	45		
M39F	A	"	39	300	44		
M39H	A	"	39	300	45		

Type	Use	Manuf.	Volt.	MA.	Base	Notes	Rider's Refer.
M40B	A	USA	40	300	33		
M40C	A	"	40	300	33		
M40D	A	"	40	300	36		
M40E	A	"	40	300	43		
M40F	A	"	40	300	44		
M40H	A	"	40	300	45		
M42A	A	"	42	300	28		
M42AJ	A	"	42	300	29		
M42B	A	"	42	300	33	Dewald 703	8-7
M42BJ	A	"	42	300	42		
M42C	A	"	42	300	33		
M42CJ	A	"	42	300	42		
M42D	A	"	42	300	36		
M42DJ	A	"	42	300	21		
M42E	A	"	42	300	43		
M42E1	A	"	42	300	33		
M42F	A	"	42	300	44	Dewald 704	11-8
M42G	A	"	42	300	44		
M42H	A	"	42	300	45	Air King 704	9-6
M42S1	A	"	42	300	37		
M42S2	A	"	42	300	37		
M42S3	A	"	42	300	37		
M44D	A	"	44	300	33		
M44C	A	"	44	300	33		
M44D	A	"	44	300	36		
M45H	A	"	45	300			
M49A	A	"	49	300	28		
M49AJ	A	"	49	300	29		
M49B	A	"	49	300	33	Dewald 616	7-6
M49BJ	A	"	49	300	42		
M49C	A	"	49	300	33		
M49CJ	A	"	49	300	42		
M49D	A	"	49	300	36		
M49DJ	A	"	49	300	21		
M49E	A	"	49	300	43		
M49E1	A	"	49	300	33		
M49F	A	"	49	300	44	Dewald 658	11-1
M49G	A	"	49	300	44		
M49H	A	"	49	300	45	Air King 257	10-1, 2
M49S1	A	"	49	300	37		
M49S2	A	"	49	300	37		
M49S3	A	"	49	300	37		
M50E3J	S	"	50	300	35	Allied A-10515	10-11
M50R	A	"	50	300			
M52H	A	"	52	300	45		
M55A	A	"	55	300	28		
M55AJ	A	"	55	300	29		
M55B	A	"	55	300	33		
M55BJ	A	"	55	300	42		
M55C	A	"	55	300	33		
M55CJ	A	"	55	300	42		
M55D	A	"	55	300	36		
M55DJ	A	"	55	300	21		
M55E	A	"	55	300	43		
M55E1	A	"	55	300	33		
M55F	A	"	55	300	44	Dewald 530	9-2
M55H	A	"	55	300	45	Air King 705	8-6
M55S1	A	"	55	300	37		
M55S2	A	"	55	300	37		
M55S3	A	"	55	300	37		
M58B	A	"	58	300	33		
M58B-275	A	"	58	300			
M61A	A	"	61	300	28		
M61AJ	A	"	61	300	29		
M61B	A	"	61	300	33		
M61BJ	A	"	61	300	42		
M61C	A	"	61	300	33		
M61CJ	A	"	61	300	42		
M61D	A	"	61	300	36		
M61DJ	A	"	61	300	21		
M61E	A	"	61	300	43		
M61E1	A	"	61	300	33		
M61F	A	"	61	300	44		
M61G	A	"	61	300	44		
M61H	A	"	61	300	45		
M61S1	A	"	61	300	37		

Type	Use	Manuf.	Volt.	MA.	Base	Notes	Rider's Refer
M61S2	A	USA	61	300	37		
M61S3	A	"	61	300	37		
M67A	A	"	67	300	28		
M67AJ	A	"	67	300	29		
M67B	A	"	67	300	33		
M67BJ	A	"	67	300	42		
M67C	A	"	67	300	33		
M67CJ	A	"	67	300	42		
M67D	A	"	67	300	36		
M67DJ	A	"	67	300	21		
M67E	A	"	67	300	43		
M67E1	A	"	67	300	33		
M67F	A	"	67	300	44		
M67H	A	"	67	300	45		
M67S1	A	"	67	300	37		
M67S2	A	"	67	300	37		
M67S3	A	"	67	300	37		
M70	A	"	70	300			
M73B	A	"	73	300	33	Motorola 59T1	9-25, 26
M74A	A	"	74	300	28		
M74AJ	A	"	74	300	29		
M74B	A	"	74	300	33		
M74BJ	A	"	74	300	42		
M74C	A	"	74	300	33		
M74CJ	A	"	74	300	42		
M74D	A	"	74	300	36		
M74DJ	A	"	74	300	21		
M74E	A	"	74	300	43		
M74E1	A	"	74	300	33		
M74F	A	"	74	300	44		
M74H	A	"	74	300	45		
M74S1	A	"	74	300	37		
M74S2	A	"	74	300	37		
M74S3	A	"	74	300	37		
M79B	A	"	79	300	33		
M79C	A	"	79	300	33		
M80A	A	"	80	300	28		
M80AJ	A	"	80	300	29		
M80B	A	"	80	300	33		
M80BJ	A	"	80	300	42		
M80C	A	"	80	300	33		
M80CJ	A	"	80	300	42		
M80D	A	"	80	300	36		
M80DJ	A	"	80	300	21		
M80E	A	"	80	300	43		
M80E1	A	"	80	300	33		
M80F	A	"	80	300	44		
M80H	A	"	80	300	45		
M80S1	A	"	80	300	37		
M80S2	A	"	80	300	37		
M80S3	A	"	80	300	37		
M84F	A	"	84	300	44	Air King 688	9-5
M86A	A	"	86	300	28		
M86AJ	A	"	86	300	29		
M86B	A	"	86	300	33		
M86BJ	A	"	86	300	42		
M86C	A	"	86	300	33		
M86CJ	A	"	86	300	42		
M86D	A	"	86	300	36		
M86DJ	A	"	86	300	21		
M86E	A	"	86	300	43		
M86E1	A	"	86	300	33		
M86F	A	"	86	300	44		
M86H	A	"	86	300	45		
M86S1	A	"	86	300	37		
M86S2	A	"	86	300	37		
M86S3	A	"	86	300	37		
M90A	A	"	90	300	28		
M90AJ	A	"	90	300	29		
M90B	A	"	90	300	33		
M90BJ	A	"	90	300	42		
M90C	A	"	90	300	33		
M90CJ	A	"	90	300	42		
M90D	A	"	90	300	36		
M90DJ	A	"	90	300	21		
M90E	A	"	90	300	43		
M90F	A	"	90	300	44		

Type	Use	Manuf.	Volt.	MA.	Base	Notes	Rider's Refer.
M90H	A	USA	90	300	45		
M92A	A	"	92	300	28		
M92B	A	"	92	300	33		
M92C	A	"	92	300	33		
M92D	A	"	92	300	36		
M92E	A	"	92	300	43		
M92E1	A	"	92	300	33		
M92F	A	"	92	300	44		
M92H	A	"	92	300	45		
M92S1	A	"	92	300	37		
M92S2	A	"	92	300	37		
M92S3	A	"	92	300	37		
M95B	A	"	95	300	33		
M95C	A	"	95	300	33		
M95D	A	"	95	300	36		
M95F	A	"	95	300	44		
M95H	A	"	95	300	45		
M98A	A	"	98	300	28		
M98AJ	A	"	98	300	29		
M98B	A	"	98	300	33		
M98BJ	A	"	98	300	42		
M98C	A	"	98	300	33		
M98CJ	A	"	98	300	42		
M98D	A	"	98	300	36		
M98E	A	"	98	300	43		
M98E1	A	"	98	300	33		
M98F	A	"	98	300	44		
M98H	A	"	98	300	45		
M98S1	A	"	98	300	37		
M98S2	A	"	98	300	37		
M98S3	A	"	98	300	37		
M105A	A	"	105	300	28		
M105B	A	"	105	300	33		
M105C	A	"	105	300	33		
M105F	A	"	105	300	44		
M105H	A	"	105	300	45		
M105S1	A	"	105	300	37		
M105S2	A	"	105	300	37		
M105S3	A	"	105	300	37		
M130E3J	H	USA	130	300	35	Allied A-10515	10-11
M575	"	"	"	"	"	"	"
M112B	H	"	"	"	"	"	"
M-83747-6	"	"	"	"	"	"	"
M-85277-3	H	"	"	"	"	145. RCA	13-14
M-85277-4	H	"	"	"	"	146. RCA	13-14
M-85277-5	H	"	"	"	"	147. RCA	13-14
K-86892-1	A	"	"	"	21	126. RCA	13-14
M-86892-2	H	"	"	"	20	127. RCA	13-14
K-86892-3	S	"	"	"	21	128. RCA CV-111, P.S. MW-50	
M-86892-4	S	"	"	"	SP	89. RCA 6Q4X	11-27
M-86892-6	H	"	"	"	"	129. RCA	13-14
M-86892-7	H	"	"	"	"	130. RCA	13-14
M-86892-8	H	"	"	"	33	131. RCA	13-14
M-86892-9	H	"	110	150	"	12. RCA 46X21, 22, 24	11-86
M-86892-10	H	"	"	"	"	91. RCA 7Q4X	11-125
M-86892-11	H	"	"	"	"	3. RCA V-101	12-38
M-91462-1	S	"	"	"	SP	90. RCA 5Q66	11-123
M-91462-2	S	"	"	"	SP	117. RCA Q24	12-34
M-91462-3	S	"	"	"	SP	132. RCA Q31	14-35
M-91462-5	S	"	"	"	SP	133. RCA Q17	14-27
M-91462-6	H	"	"	"	"	134. RCA	13-14
M-91462-7	A	"	"	"	"	135. RCA	13-14
M-91462-8	H	"	"	"	"	136. RCA	13-14
M-920117-1	H	"	"	"	"	137. RCA	13-14
M-920146-1	S	"	"	"	"	138. RCA	13-14
K-95178-7	S	"	"	"	"	139. RCA Q11	14-16
K-95178-8	S	"	"	"	"	140. RCA Q11	14-16
M-95178-9	S	"	"	"	"	141. RCA Q11	14-16
K-95178-10	S	"	"	"	SP	142. RCA Q11	14-16
MT-30A	A	USA	30	300	"	"	"
MT-300	S	"	"	"	33	118. Freed 27 D	9-2
MT-650	S	"	"	"	26	119. Freed 30 D	9-2
MX23A	A	USA	23	300	6		
MX23B	A	"	23	300	11		

Type	Use	Manuf.	Volt.	MA.	Base	Notes	Rider's Refer.
MX23C	A	USA	23	300	11		
MX23D	A	"	23	300	12		
MX30A	A	"	30	300	6		
MX30B	A	"	30	300	11		
MX30C	A	"	30	300	11		
MX30D	A	"	30	300	12		
MX36A	A	"	36	300	6		
MX36B	A	"	36	300	11		
MX36C	A	"	36	300	11		
MX36D	A	"	36	300	12		
MX42B	A	"	42	300	11		
MX42C	A	"	42	300	11		
MX42D	A	"	42	300	12		
MX49A	A	"	49	300	6		
MX49B	A	"	49	300	11		
MX49C	A	"	49	300	11		
MX49D	A	"	49	300	12		
MX55B	A	"	55	300	11		
MX55C	A	"	55	300	11		
MX55D	A	"	55	300	12		
MX61A	A	"	61	300	6		
MX61B	A	"	61	300	11		
MX61C	A	"	61	300	11		
MX61D	A	"	61	300	12		
MX67A	A	"	67	300	6		
MX67B	A	"	67	300	11		
MX67C	A	"	67	300	11		
MX67D	A	"	67	300	12		
MX74A	A	"	74	300	6		
MX74B	A	"	74	300	11		
MX74C	A	"	74	300	11		
MX74D	A	"	74	300	12		
MX80A	A	"	80	300	6		
MX80B	A	"	80	300	11		
MX80C	A	"	80	300	11		
MX80D	A	"	80	300	12		
MX86B	A	"	86	300	11		
MX86C	A	"	86	300	11		
MX86D	A	"	86	300	12		
MX92B	A	"	92	300	11		
MX92C	A	"	92	300	11		
MX92D	A	"	92	300	12		
MX98A	A	"	98	300	6		
MX98B	A	"	98	300	11		
MX98C	A	"	98	300	11		
MX98D	A	"	98	300	12		
MX105B	A	"	105	300	11		
MX105C	A	"	105	300	11		
MX105D	A	"	105	300	12		
MX-408-U	B	"	1.0	80	22		
MY6B	A	USA	6	300	40		
MY6C	A	"	6	300	40		
MY6D	A	"	6	300	41		
MY11A	A	"	11	300	39		
MY11B	A	"	11	300	40		
MY11C	A	"	11	300	40		
MY11D	A	"	11	300	41		
MY17A	A	"	17	300	39		
MY17B	A	"	17	300	40		
MY17C	A	"	17	300	40		
MY17D	A	"	17	300	41		
MY23A	A	"	23	300	39		
MY23B	A	"	23	300	40		
MY23C	A	"	23	300	40		
MY23D	A	"	23	300	41		
MY30A	A	"	30	300	39		
MY30B	A	"	30	300	40		
MY30C	A	"	30	300	40		
MY30D	A	"	30	300	41		
MY36A	A	"	36	300	39		
MY36B	A	"	36	300	40		
MY36C	A	"	36	300	40		
MY36D	A	"	36	300	41		
MY42A	A	"	42	300	39		
MY42B	A	"	42	300	40		
MY42C	A	"	42	300	40		

Type	Use	Manuf.	Volt.	MA.	Base	Notes	Rider's Refer.
MY42D	A	USA	42	300	41		
MY49A	A	"	49	300	39		
MY49B	A	"	49	300	40		
MY49C	A	"	49	300	40		
MY49D	A	"	49	300	41		
MY55A	A	"	55	300	39		
MY55B	A	"	55	300	40		
MY55C	A	"	55	300	40		
MY55D	A	"	55	300	41		
MY61A	A	"	61	300	39		
MY61B	A	"	61	300	40		
MY61C	A	"	61	300	40		
MY61D	A	"	61	300	41		
MY67A	A	"	67	300	39		
MY67B	A	"	67	300	40		
MY67C	A	"	67	300	40		
MY67D	A	"	67	300	41		
MY74A	A	"	74	300	39		
MY74B	A	"	74	300	40		
MY74C	A	"	74	300	40		
MY74D	A	"	74	300	41		
MY80A	A	"	80	300	39		
MY80B	A	"	80	300	40		
MY80C	A	"	80	300	40		
MY80D	A	"	80	300	41		
MY86A	A	"	86	300	39		
MY86B	A	"	86	300	40		
MY86C	A	"	86	300	40		
MY86D	A	"	86	300	41		
MY90B	A	"	90	300	40		
MY90C	A	"	90	300	40		
MY90D	A	"	90	300	41		
MY98A	A	"	98	300	39		
MZ6B	A	USA	6	300	24		
MZ6C	A	"	6	300	24		
MZ11B	A	"	11	300	24		
MZ11C	A	"	11	300	24		
MZ17A	A	"	17	300	22		
MZ17B	A	"	17	300	24		
MZ17C	A	"	17	300	24		
MZ23B	A	"	23	300	24		
MZ23C	A	"	23	300	24		
MZ30B	A	"	30	300	24		
MZ30C	A	"	30	300	24		
MZ36B	A	"	36	300	24		
MZ36C	A	"	36	300	24		
MZ42B	A	"	42	300	24		
MZ42C	A	"	42	300	24		
MZ49B	A	"	49	300	24		
MZ49C	A	"	49	300	24		
MZ55A	A	"	55	300	22		
MZ55B	A	"	55	300	24		
MZ55C	A	"	55	300	24		
MZ61B	A	"	61	300	24		
MZ61C	A	"	61	300	24		
MZ67B	A	"	67	300	24		
MZ67C	A	"	67	300	24		
MZ74A	A	"	74	300	22		
MZ74B	A	"	74	300	24		
MZ74C	A	"	74	300	24		
MZ80A	A	"	80	300	22		
MZ80B	A	"	80	300	24		
MZ80C	A	"	80	300	24		
MZ86A	A	"	86	300	22		
MZ86B	A	"	86	300	24		
MZ86C	A	"	86	300	24		
MZ92A	A	"	92	300	22		
MZ92B	A	"	92	300	24		
MZ92C	A	"	92	300	24		
MZ98B	A	"	98	300	24		
MZ98C	A	"	98	300	24		
MZ105B	A	"	105	300	24		
MZ105C	A	"	105	300	24		

Type	Use	Manuf.	Volt.	MA.	Base	Notes	Rider's Refer.
MB-1	B	USA				Warwick 537	
MB-2	B	"				18. Motorola 52T, 52 Y	15-44
MB-3	B	"					
MB-4	B	"					
MB-5	B	"					
MB-6	B	"					
MB-7	B	"					
MB-8	B	"					
MS 3		(BA)	200	200			
MS 5		"	165*	300	1		
MS41	A	USA	41	300		201. Radio Wire Tel. JS-242	20-6
NTH							
NVA							
NUB							
P17287		USA					
P26871	A	"					
P27287 (27287)	A	"	49	300	33	207. Equiv. to L49E1	
P-32351 (W-32351)	H	"				143. Westinghouse Int. WRL-165 14-15	
P-32353 (W-32353)	A	"	Shorting	Plug		144. Westinghouse Int. WRL-165 14-15	
PB 57	A	"	100	100		247.	
R6V	R	USA					
R43B2	A	"					
R105		Marat.	20*	1150			
R115		"	30*	1150			
R130-180		USA					
R130-T380		"					
R161-300		"					
R300	A	"					
R1000	A	"					
R1000R		"					
R1100	A	"					
R1900		"					
R3003	A	"	60	300	32	25. Webster Co, D (OC3-OC10)	8-2
RL180		Cast.	225	180			
RO 4010		Viss.		100	10		
RR 100		Vatea	50-70	100	82	231.	
RR 180		"	16	180	82	235.	
RR-782	S	USA				69. GE HJ 905	11-77
RR-783	S	"		300		157. GE X 125	13-23
RR-790	H	"		300		102. GE JE-810	12-88
RR-797	H	"		150		158. GE X-105 V	14-29
RR-798	A	"		150		159. GE X-105 V	14-29
RR-799	S	"		150		160. GE X-105 V	14-29
RR-1180		Vatea	35-100	180	82	236.	
RR-2180		"	100-240	180	82	237.	
RR-7003	H	USA				161. GE X-118	13-5
RR-7004	S	"				162. GE X-118 Y	13-5
RR-7005	A	"				163. GE X-118 Z	13-5
RR-7007	S	"		300		164. GE X-166	13-29
RR-7008	S	"		300		165. GE X-166 Y	13-29
RRB-001	S	"				154. GE X-153	15-18
RRB-002	A	"				155. GE X-153	15-18
RRB-003	S	"				156. GE X-317 D2	15-40
RTC 1		Viss.	50 #	300	10		
RTC 3		"	20-90	150	23		
SR150		Sator	70	150			
SR180		"	220	180			
ST(or SW)507300	T	USA				Stewart-Warner TV	
T-5	A	USA					
T-1904 (1904)		Phil.	70*	100	82		
TBR-102D	T	USA				Teletone TV	
TBR-103D	T	"				"	
TBR-104D	T	"				"	
TJ 102 L		"				"	
TJ 801 K		"				"	
TJ 801 L		"				"	
TU-34	A	"					
TU-83	A	"					
U 0.2-0.5A		Oram	12	500	1		
U 1		Dario	200*	200	66		
U 1.1-2A		Oram	10	2000	1		

Type	Use Manuf.	Volt.	MA.	Base	Notes	Rider's Refer.
U 3V-0.08A	Osram	2.2-3.8	80	1		
U 4A	"	8.0*	4000	1		
U 6A	"	8.0*	6000	1		
U 70/140	Trio.	100*	200	69		
U 518 H	Osram	3.0-7.0	180	3		
U 918	"	7.0-11	180	82		
U 918/3	"	7.0-11	180	1		
U 920 (U-920/7)	"	7.5-11	200	66		
U 920 P	"	7.5-11	200	66		
U 936	"	7.5-11	360			
U 1010	"	8.0-13	100	66		
U 1010 P	"	8.0-13	100	2		
U 1218	"	10.5-13.5	180	82		
U 1218/3	"	10.5-13.5	180	1		
U 1220 (U 1220/5)	"	10-14	200	66		
U 1220/6	"	10.5-13.5	200	66		
U 1220 P	"	10-14	200	66		
U 1230	"	10-14	300	5		
U 1230/4	"	10.5-13.5	300	1		
U 1230/4S	"	10-14	300	59		
U 1420 (U 1420/5)	"	12.5-15.5	200	66		
U 1513	"	10-20	130	59		
U 1518	"	12-18	180	82		
U 1518/3	"	12-18	180	1		
U 2003	"	12	10-120	5		
U 2020 (U 2020/5)	"	19-25	200	66		
U 2410	"	20-28	100	3		
U 2410 P	"	20-28	100	2		
U 3007	"	26-34	70	5		
U 3505 VE	"	30-39	50	2		
U 3620 (U 3620/5)	"	34-42	200	66		
U 4520 (U 4520/5)	"	40-50	200	66		
U 4520/6	"	40-50	200	66		
U 4520/G	"	40-50	200	2		
U-RL200	Cast.	200	200	66		
UP-591	S USA			8	RCA UP-972 AC Package	1-20, 23
URB 001	A	Universal	Repl. Type		See Chart 3.	
URB 002	A	"	"	"	"	
URB 003	A	"	"	"	"	
URB 004	A	"	"	"	"	
URB 005	A	"	"	"	"	
URB 006	A	"	"	"	"	
URB 007	A	"	"	"	"	
URB 008	A	"	"	"	"	
URB 009	A	"	"	"	"	
UX 2.5/6	Osram	2.0-3.5	5000			
UX 23	USA					
V60	Trio.	50-70	100	82	231.	
V70	"	100*	200	66		
V70 U	"	105*	200	72e		
V80	"	90-230	140	82	233.	
V100	"	35-100	180	82	236.	
V140	"	200*	200	66e		
V140 U	"	200*	200	66e		
V150	"	100-240	180	82	237.	
V180a	"	35-150	180	82	238.	
W 1	Osram	100	10	60	242.	
W1	Therm.	30*	1150	80		
W 2	Osram	100	10	60	242.	
W2	Therm.	20*	1150	15		
W 3	Osram	100	10	60	242.	
W 4	"	60	10	60	242.	
W15	Rec.	30*	1150	80		
W20	"	20*	1150	79		
W329	Long.	30*	1150	82e		
W452	"	20*	1150	79		
W4588						
W-16054	A USA	45	150	28	Sears 7061 Phono	13-74
W-28864B	A	92	300		248. Crosley 10 (Early)	4-1
W-29953-A	A	60	300		249. Crosley 38	4-1
W-32351 (P-32351)	H	105	150		143. Westinghouse Inter. WRL-165	14-15
W-32353 (P-32353)	A	Shorting Plug			144. " " " "	14-15
W-40655						
W-41187	S				37. Crosley 1336	8-49
W-42105	B					

Type	Use	Manuf.	Volt.	MA.	Base	Notes	Rider's Refer.
W-42505		USA					
W-42520	A	"	47	300		36. Crosley 676	8-27
W-43251	B	"			6		
W-43282	B	"			6		
W-43357 (K49B)	A	"	49	300	33	Crosley 506	8-9
W-43506	"	"					
W-44118	B	"	1.0	420	6	CROSLLEY 557	9-21, 22
W-44338	S	"				49. Crosley 647	9-39
W-44416	"	"					
W-45788	A	"	80	300	28	23. Crosley 418	9-11
W-46416	A	"	55	300	33	15. Crosley 10	12-1, 2
W-46773	A	"	49	300	33	21. Crosley 15	12-7
W-48669	"	"					
W-48670	"	"					
W-143357	"	"					
WB 800	"	"	2.0	800		Westinghouse Aeriola Grand	
WE 6	Rectr.	"	19.5	3000	1		
WE 15	"	"	50-70	100	82	231.	
WE 22	"	"	24/24	600/500	79	220.	
WE 33	"	"	24/24	800/1150	79	221.	
WE 34	"	"	25/25/160	1150/180	83	226.	
WE 44	"	"	28/28	1150/1300	79	222.	
WE 45	"	"	42	1300	79	223.	
WE 46	"	"	42	500	79	224.	
WE 55	"	"	16/16	1300/1100	79	225.	
WE 1012	"	"	18*	5700	1		
W1 33	Phil.	"	10-14	1100	1		
W133	Valvo	"	20*	1150	79		
W1100	"	"	50-70	100	82		
W1150	"	"	50-70	150	82		
W1180a	"	"	35-100	120	82	236.	
W1180b	"	"	100-240	180	82		
W1 250	"	"	70e	250	82	234.	
W1 V 1700	"	"	40-60	1700	82	239.	
W1 V 2000	"	"	40-60	2050	82	240.	
WL 706	"	"	110	200	SP		
WL 756	"	"	150*	15			
WL 1896	Tele.	"	4.0-8.0	250	1		
WR 60/1	Rectr.	"		400-530	1		
WR 60/2	"	"		200-270	1		
WR 90/1	"	"		500-800	1		
WR 90/2	"	"		250-400	1		
WR 120/1	"	"		800-1100	1		
WR 120/2	"	"		400-550	1		
WR 150/1	"	"		1100-1400	1		
WR 150/2	"	"		550-700	1		
WRL5 (WRL-5)							
WW48		USA			48	14. RCA BK-41	11-64
X10A	A	USA	10	300	6		
X23A	A	"	23	300	6		
X30A	A	"	30	300	6		
X35-35	A	"					
X36A	A	"	36	300	6		
X42A	A	"	42	300	6		
X49A	A	"	49	300	6		
X55A	A	"	55	300	6		
X55B	A	"	55	300	7		
X61A	A	"	61	300	6		
X67A	A	"	67	300	6		
X74A	A	"	74	300	6		
X80A	A	"	80	300	6		
X86A	A	"	86	300	6		
X92A	A	"	92	300	6		
X96A	A	"	96	300	6		
X98A	A	"	98	300	6		
X105A	A	"	105	300	6		
XB 90							
XD-5 (X49C)	A	"	49	300	33	Andrea 62X	9-20
Y11A	A	USA	11	300	39		
Y17A	A	"	17	300	39		
Y23A	A	"	23	300	39		
Y30A	A	"	30	300	39		
Y36A	A	"	36	300	39		
Y42A	A	"	42	300	39		
Y49A	A	"	49	300	39		

Type	Use	Manuf.	Volt.	MA.	Base	Notes	Rider's Refer.
Y55A	A	USA	55	300	39		
Y61A	A	"	61	300	39		
Y67A	A	"	67	300	39		
Y74A	A	"	74	300	39		
Y80A	A	"	80	300	39		
Y86A	A	"	86	300	39		
Y98A	A	"	98	300	39		
YTD-16040	A	"	-See 16040-				
Y-TU-9		"					
Y-TU-16042	A	"	-See 16042-				
Z	A	USA	Equiv. to JFD Type C.			See Chart 6.	
Z6A	A	"	6	300	22		
Z11A	A	"	11	300	22		
Z17A	A	"	17	300	22		
Z23A	A	"	23	300	22		
Z30A	A	"	30	300	22		
Z36A	A	"	36	300	22		
Z42A	A	"	42	300	22		
Z49A	A	"	49	300	22		
Z55A	A	"	55	300	22		
Z61A	A	"	61	300	22		
Z67A	A	"	67	300	22		
Z74A	A	"	74	300	22		
Z80A	A	"	80	300	22		
Z86A	A	"	86	300	22		
Z92A	A	"	92	300	22		
Z98A	A	"	98	300	22		
Z105A	A	"	105	300	22		
.0C2 (0C2)	A	USA					
.03C (03C)	A	"					
.038 (038)	R	"	60*	1100	7		
.042 (042)	B	"					
1	B	"	1.0	1000	5	See Chart 7.	
1-1	R	"	0.3-1.2	100	6		
1-60-A		"					
1A	B	"	1.0	250	5	See Chart 7.	
1A1	B	"	0.3-1.2	500	6	Noblitt Sparks 51-B	7-8
1A2	B	"	0.3-1.2	200g	10	Sears 1932	7-69
1A5	R	"	5.0-25	100	7		
1A-10	S	"					
1B1	B	"	0.3-1.2	360	6	Sears 1920	6-46
1B2	B	"	0.3-1.2	260	10	Equiv. to 31	
1C1	B	"	0.3-1.2	740	6	Philco 643	7-105
1C2	B	"	0.3-1.2	120	10	Equiv. to 52	
1D1	B	"	0.3-1.2	240	6	Philco 233 AG	8-93
1D2	B	"	0.3-1.2	420	17		
1E1	B	"	0.3-1.2	480	6	Sears 1923	7-26
1E2	B	"	0.3-1.2	660	17		
1F1	B	"	1.0	720	6	Sears 1936	7-35
1G1	B	"	1.0	420	6	Sears 1922A	6-49
1H1	B	"	1.0	540	6	Hetro 6LB	6-4
1H4		"					
1H10	C	"	12-30	150-165			
1H11		"					
1H22		"					
1HMA		"					
1HT2		"			50		
1HT4		"			50		
1HT11		"			50		
1HTF10	C	"	12-30	150-165	53	Beckman 72 pH Meter	
1J1	B	"	0.3-1.2	620	6	Equiv. to 6-1	
1K1	B	"	1.0	550	6		
1L1	B	"	1.0	360	22		
1M1	B	"	1.0	480	22	Sears 4404	7-55
1P1	B	"	1.0	420	22	Sears 4409	7-59
1Q1	B	"	1.0	720	22		
1R1G	B	"	0.3-1.2	540	22	Stewart Warner 1611-D	8-7
1S1	B	"	1.0	660	22		
1T1G	B	"	0.3-1.2	560	22		
1TF10	C	"	12-30	100-110			
1U1	B	"	1.0	740	22	Sears 4426A	8-25
1V1	B	"	1.0	560	6		
1W1	B	"	1.0	660			
1X1	B	"	0.3-1.2	780	6		
1Y1	B	"	1.0	540	6		
1Z1	B	"	0.3-1.2	900	6		

Type	Use	Manuf.	Volt.	MA.	Base	Notes	Rider's Refer.
2	A	USA	9	300	6	Philco 46	1-13
2-1	B	"	"	"	"	"	"
2-A-5	C	"	5-25	200	7	"	"
2A10 (2-A-10)	C	"	12-30	200-220	"	"	"
2A12	"	"	"	"	"	"	"
2A16	"	"	"	"	"	"	"
2A20	"	"	20-40	250	"	"	"
2B14	S	"	12-20	200	22	"	"
2BG	B	"	4.0	300	"	Air King 850	9-14
2CR-241	A	"	"	"	"	"	"
2H1	B	"	1.2	240	6	Equiv. to 1D1	"
2H-2R	B	"	"	"	"	"	"
2H4	"	"	"	"	"	"	"
2H5	C	"	5.0-25	250	7	"	"
2H 10	C	"	12-30	250-280	"	"	"
2H 20	R	"	"	"	"	"	"
2HT2	"	"	"	"	"	"	"
2HT4	S	"	3.0-8.0	250	50	"	"
2LR-12	A	"	"	"	"	"	"
2LR-212	A	"	42	300	41	Emerson 1071W Ch. U6C	7-13
2M2	S	"	"	"	"	"	"
2R67	B	"	"	"	"	"	"
2UR	"	"	"	"	"	"	"
2UR-215	A	"	55	300	33	Equiv. to L55B	"
2UR-224 (L49B)	A	"	49	300	33	Emerson AM-153	9-1
2VR	"	"	"	"	"	"	"
2VR-215 (L55B)	A	"	55	300	33	Emerson 118,120,126	7-12
3	H	USA	128	250	6	Philco 46-E	1-13
3-1	B	"	0.3-1.2	300	6	"	"
3-2	C	"	"	"	"	"	"
3-4	S	"	4.0-8.0	300	22	"	"
3,6D5	A	"	"	"	"	"	"
3-7	"	"	"	"	"	"	"
3-11	"	"	"	"	"	"	"
3-12	"	"	"	"	"	"	"
3-14	"	"	"	310-325	22	"	"
3-14B	"	"	"	"	"	"	"
3-16	S	"	10-18	300	22	"	"
3-20	R	"	"	"	"	"	"
3-25	A	"	"	"	11	"	"
3-38A	"	"	"	"	"	"	"
3-40	A	"	40	300	6	Lafayette C-78	9-8
3-50A	A	"	50-80	280	22	"	"
3-100	S	"	"	"	"	"	"
3-150	C	"	30-60	300	7	"	"
3-320	S	"	70-130	300	7	"	"
3-A-5	C	"	5.0-25	300	7	"	"
3A10	C	"	12-30	300-330	"	"	"
3A20	S	"	20-41	300	"	"	"
3A20-3	"	"	"	"	"	"	"
3CR	"	"	"	"	"	"	"
3CR-241 (L49D)	A	"	49	300	36	Emerson AP-165	9-13
3ER	"	"	"	"	"	"	"
3ER-248 (L49DJ)	A	"	49	300	21	Emerson F117	7-25
3ER-249	H	"	167	300	208.	Emerson F117	7-25
3H1	B	"	1.2*	360	6	Equiv. to 1B1	"
3H-1-7 (3H17)	"	"	5.0-10	340	24	"	"
3H-1C	"	"	"	"	"	"	"
3H2E	B	"	"	"	"	"	"
3H10	R	"	12-30	350-390	24	"	"
3H11	R	"	"	"	"	"	"
3H17	R	"	5.0-10	340	24	"	"
3H20	R	"	"	"	"	"	"
3H25	"	"	"	"	"	"	"
3H-220	C	"	70-130	350	7	"	"
3HTF4	"	"	4.3-8.3	340-370	53	"	"
3HTF4A	"	"	"	"	53	"	"
3HR-253	S	"	112	150	"	209. Emerson M-134	8-21
3HZ-419	A	"	Shorting	Plug	"	2.	"
3MZ-419A	A	"	"	"	"	"	"
3T2	"	"	"	"	50	"	"
3T4	"	"	"	"	50	"	"
3T7	"	"	"	"	50	"	"
3T11	"	"	"	"	50	"	"
3TF4	"	"	4.3-8.3	280-320	53	"	"

Type	Use	Manuf.	Volt.	MA.	Base	Notes	Rider's Refer.
3TF7		USA	8.6-16.6	290-330	53		
3TFV4	S	"	3.0-6.0	300	53		
3TK2	"	"	4.0-8.5	280-300			
3V4	C	"	3.0-6.0	300	22		
4 (PHILCO)	H	USA	115-117	400	6	Philco 47E	3-47
4-1	B	"	1.2*	420	6	Sentinel 95B	10-24
4-12	"	"	12	400	22		
4-20	C	"					
4-150	R	"					
4-220	C	"	70-130	400	7		
4A	B	"	4.0	240	6	Midwest 8-38	8-31
4A-1 (4A1)	B	"	4.0	300	6		
4A-5 (4A5)	R	"	5.0-25	400	7		
4A10	B	"	12-30	400-450			
4A21 (GL-4A21)	R	"	7.0-15	1600	22		
4AB 1094	"	"					
4H1	B	"	1.0	480	6	Sentinel 91B	10-21
4H3	"	"					
4H4	"	"	4.3-10.0	500	22		
4H4C	C	"	4.5-7.5	440-470	22	National HRO 60	
4H5	C	"	5.0-25	450	7		
4H10	C	"	12-30	450-500			
4H11	"	"					
4H-220	C	"	70-130	450	7		
4HTF4	"	"					
4P-45	A	"	Universal Repl. Type			See Chart 4.	
4SR-211	S	"	26	2650		213. Emerson AS 179	8-49
4SR-311	A	"					
4-TU-9	A	"					
4V-199	B	"	1.2	60	5	See Chart 7.	
4XR-308	"	"					
5	H	USA	115	460	6	Philco 47E	3-47
5-1	B	"	1.2*	500	6		
5-7	"	"					
5-10	R	"					
5-16	C	"	16	500	7	RCA 223	5-95
5-20	R	"					
5-150	C	"	30-60	500	7		
5-220	C	"	70-250	500	7		
5A5 (5-A-5)	R	"	5.0-25	500	7		
5A10	C	"	12-30	500-560			
5B	A	"	49	300	11	Equiv. to KX49B	
5E1	B	"	1.0	500	6	Delco R 2050	9-39
5H-1 (5H1)	B	"	0.3-1.2	560	6	Sears 1992X	7-51
5H-3	S	"			7e		
5H-4	"	"					
5H-5	C	"	5.0-25	550	7		
5H-10	C	"	10-30	550-600			
5H-11	"	"					
5H-20	R	"					
5H-150	C	"					
5H-200	H	"	70-130	550	7		
5H-220	C	"					
5T4	"	"			50		
5TF4	"	"	6.1-7.4	550	53		
6 (PHILCO)	B	USA	0.6-1.4	685-700	6	Philco 623	6-29
6-1	B	"	1.0	620	6	Sentinel 7700	5-35
6-2	"	"					
6-3	"	"					
6-4	"	"					
6-7	"	"	12.5	650			
6-8B	"	"					
6-11	S	"	8.0-12	600	22		
6-12	"	"	10-23	650			
6-13	"	"					
6-14	"	"	1.5-4.5	700			
6-20	C	"	20-40	600	7		
6.125	A	"	42	300	21	Equiv. to L42DJ	
6.126 (L36DJ)	A	"	36	300	21	Carod 731	8-9
6.128	A	"					
6.129 (L49DJ)	A	"	49	300	21	Carod 762	9-13
6.130	A	"		300		Carod 830A	8-11
6.133	A	"	49	300	29	Carod Challenger I	8-3
6.133A	A	"					

Type	Use	Manuf.	Volt.	MA.	Base	Notes	Rider's Refer.
6-134	A	USA					
6-135	A	"	23	300	29	Equiv. to K23AJ	
6-138	A	"	49	300		Carod 602 C	9-9
6-141	A	"	47	300		Carod 803 L	10-19
6-142	"	"					
6-150	"	"					
6-159	H	"	105	150		100. Carod 3011	12-4
6-170	A	"				194. Carod C201	14-23
6-171	S	"				195. Carod C201	14-23
6-173	A	"	43	300		196. Carod 3B70	14-17
6-220	C	"					
6A	"	"					
6AA	B	"	1.0	500	6	Mont. Ward 77, 95	4-18
6-A-5	R	"	5.0-25	600	7		
6A10	R	"	12-30	600-650			
6A15	R	"	15	600	22		
6A20	"	"					
6B	A	"	49	300	11		
6E1	B	"	1.0	620	6	Warwick 7 Tube	7-3
6H1	B	"	1.0	660	6		
6H4	"	"					
6H6 (6-H-6)(6H-6)	S	"	5.1-8.3	700			
6H10	R	"	12-30	650-700			
6IP4	"	"					
6T2	"	"			50		
6T3	"	"			50		
6T4	"	"			50		
6TP4	S	"	4.0-8.0	570-590	53		
6TP4A	S	"	4.0-8.0	550	53		
6V-199	B	"	2.7	60	5	See Chart 7.	
7	H	USA	176	300	6	Philco 248 E	
7-1	B	"	1.2*	720	6		
7-4	"	"					
7-11	"	"					
7-20	R	"	20-40	700	7		
7-150	R	"	30-60	700	7		
7-A-5	R	"	5.0-25	700	7		
7A10	C	"	12-30	700-800			
7BP3 (Majestic)	R	"	35		3	See Chart 5.	
7BP6 (Majestic)	R	"	70		3	" " "	
7H1	B	"	1.2	745	6	Equiv. to 1C1	
7H4	"	"	4.3-7.6	750			
7H4B	"	"					
7H10	R	"	12-30	750-850	22		
7H11	"	"					
7H12	"	"					
7KTP3	"	"					
7KTP4	"	"	4.3-8.3	800			
7T4	"	"			50		
8	H	USA	132	300	6	Philco 247 E	
8-1	B	"					
8-3B	"	"					
8-4	"	"					
8-11	"	"					
8-20	R	"					
8-150	C	"					
8-220	C	"					
8-A-5	R	"	5.0-25	800	7		
8A10	R	"	12-30	800-900			
8P3 (Majestic)	R	"	25		3	See Chart 5.	
8P6 (Majestic)	R	"	25/50		3	" " "	
8XR-432	A	"	Shorting	Plug		94. Emerson EX-386	12-34
8XR-433	S	"				95. Emerson EX-386	12-34
8XR-434	S	"				96. Emerson EX-386	12-34
9	A	USA	50	300	6	Philco 48	3-22
9-1	B	"	1.0	900	6		
9-3	S	"	3.0-9.0	950	22		
9-4	"	"	4.3-9.7	950			
9-7	R	"	7.0	900	7		
9-10	R	"	10	900	3/7		
9-11	"	"					
9-20	R	"	20-40	900	7		
9-150	C	"	30-60	900	7		
9-220	C	"					

Type	Use	Manuf.	Volt.	MA.	Base	Notes	Rider's Refer.
9-A-5	R	USA	5.0-25	900	7		
9A10	C	"	12-30	900-1000			
9M15822	C	"					
9PJ (Majestic)	R	"	35			See Chart 5.	
9P6 (Majestic)	R	"	35			" " "	
9V10	C	"	5.0-25	800	1		
10-1	B	USA					
10-3	"	"					
10-4	"	"					
10-4A	"	"					
10-4B	R	"	4.0-8.0	900	22		
10-4C	R	"	6.8-9.1	1000	22		
10-4D	"	"					
10-4E	"	"					
10-10	R	"	10-30	1000	7		
10-20	R	"	20	1000	7		
10.23	"	"					
10-23-1, 2, or 3	A	"	Universal Repl. Types			See Chart 3.	
10-23-A, E, or F	A	"				" " "	
10-25	R	"	25	1000	7		
10-150	"	"					
10-220	"	"					
10-610	R	"	8.0	450	28	Troy 95	B-2
10.800	"	"					
10A	A	"	10	300		Spiegel 4010	10-37
10AB	B	"	1.0	550	6	Wurlitzer B-6	5-19
10-A-5	R	"	5.0-25	1000	7		
10A10	R	"	12-30	1000-1150	7		
10A12	"	"					
10B	A	"	10	300	33		
10T1	S	"	10	700		210.	
10UR-511	H	"	140	300	20	189, Emerson CU-446	14-5
10UR-570	A	"	35	300	21	190, Emerson CU-446	14-5
10-V-10	R	"	10-20	1000	7		
11.3	A	USA		300		193, Freed 40	14-1
11-4	"	"					
11-10	R	"	10-30	1100	7		
11-11	"	"					
11-20	R	"	20-40	1100	7		
11-150	R	"	30-60	1100	7		
11A	A	"	11	300	28		
11AJ	A	"	11	300	29		
11-A-5 (11A5)	R	"	5.0-25	1100	7		
11-A-10 (11A10)	R	"	12-30	1100-1250	7		
11 KA	A	"	11	300	28		
11 KB	A	"	11	300	33		
11 KC	A	"	11	300	33		
11 KD	A	"	11	300	36		
11 LB	A	"	11	300	33		
11 LC	A	"	11	300	33		
11 LD	A	"	11	300	36		
12-4	"	USA					
12-7	"	"					
12-20	R	"	20-40	1200	7		
12-150	"	"					
12-220	"	"					
12A5 (12-A-5)	R	"	25	1200	7		
12A10	R	"	12-30	1100-1350			
13-4	R	USA	4.0-7.0	1300	22		
13-10	R	"	10-20	1300	7		
13-20	R	"	20-40	1300	7		
13-A-5	R	"	5.0-25	1300	7		
13A10	R	"	12-30	1300-1500			
13CR8	"	"					
13T4	R	"	4.0-8.0	1300	22		
13U8	"	Ultr.	200*	200	66		
13U9	"	"	100*	200	66		
14-20	R	USA	20-40	1400	7		
14-A-5	R	"	5.0-25	1400	7		
14A10	R	"	12-30	1400-1600			
14 LD	A	"	14	300	12		

Type	Use	Manuf.	Volt.	MA.	Base	Notes	Rider's Refer.
15-10	R	USA	10-30	1500	7		
15-11	R	"	10-16	1500 1600	22		
15-20	R	"	20-40	1500	7		
15A5		"					
15A20	R	"	20	1500	22		
16-4	R	USA	3.0-8.0	1600	22		
16-20	R	"					
16A10		"					
17-2		USA					
17-3		"	4.0-8.0	1750			
17A	A	"	17	300	28	Pacific 42	10-7
17AJ	A	"	17	300		26. Allied A-10515	10-11
17A470303	T	"				211. Motorola TV	
17A485459	T	"				212. " "	
17 KA	A	"	17	300	28		
17 KB	A	"	17	300	33		
17 KC	A	"	17	300	33		
17 KD	A	"	17	300	36		
17 KE	A	"	17	300	43		
17 LB	A	"	17	300	33		
17 LC	A	"	17	300	33		
17 LD	A	"	17	300	36		
17 MB	A	"	17	300	33		
17 MC	A	"	17	300	33		
17 MD	A	"	17	300	36		
18		USA					
18-3	R	"	3.0-8.0	1800	22		
18-10	R	"	10-20	1800	7		
18-110A	A	"	35	300	37	Automatic 135	12-8
20-1		USA					
20-3		"					
20-4	R	"	5.0-12	2000	22		
20-4B	R	"	4.0	1450	22		
20-10	R	"					
20-A-5	R	"	4.0-25	2000	7		
22-4	R	"	4.0-8.0	2200	22		
22-10	R	"	10-30	2200	7		
23 (UX-23)		"					
23-3		"					
23-55-1, 2, or 3	A	"	Universal Repl. Types			See Chart 3.	
23-55-A, E, or F	A	"				" " "	
23A	A	"	23	300	28		
23AJ	A	"	23	300	29		
23 KB	A	"	23	300	33		
23 KC	A	"	23	300	33		
23 KD	A	"	23	300	36		
23 LB	A	"	23	300	33		
24-4		"					
24B856	H	"	110	300		202. United Motors 508	19-25
24B874	H	"	130	300	20	203. Hallcrafters S-52	21-7
24B875 (K30CJ)	A	"	30	300	21	204. " "	21-7
25B2	A	"	25	300			
26C5		"					
27A		"					
28D4	R	"	2.5-5.0	2300	22		
30	B	USA	1.2*	120	10	Sears 1862	5-41
30A (Octal)	A	"			28		
30AG (UX)	A	"			11		
30AJ	A	"			29		
30 KB	A	"	30	300	33		
30 KC	A	"	30	300	33		
30 KD	A	"	30	300	36		
30 LB	A	"	30	300	33		
30 LC	A	"	30	300	33		
30 LD	A	"	30	300	36		
31	B	"	1.2*	260	10	Sears 1712	4-18, 19
32	A	"	52	300	45	Equiv. to BK52H	
32DR		"					
33-310		"					
33-3310		"					
33-3391	S	"		300		191. Philco 41-759	14-12
33-3414	S	"		150		192. Philco 42-706	14-57

Type	Use	Manuf.	Volt.	MA.	Base	Notes	Rider's Refer.
33 A	A	USA	33	300	28		
33 AG	A	"	33	300	6		
33 AJ	S	"	33	300	35	Allied A-10515	10-12
33 H	A	"					
34 A	A	"			28		
35-2	A	"				103. Pilot T-47	12-4
35-3	S	"				104. Pilot T-47	12-4
35-4	S	"				105. Pilot T-47	12-4
35-5	S	"				106. Pilot T-47	12-4
35-9	A	"				166. Pilot T-131	13-11
35-10	S	"				167. Pilot T-131	13-11
35-11	S	"				168. Pilot T-131	13-11
35-12	S	"				169. Pilot T-131	13-11
35-13	A	"				170. Pilot T-43	13-8
35-14	S	"				171. Pilot T-43	13-8
35-15	S	"				172. Pilot T-43	13-8
35-20	S	"				173. Pilot T-133	13-14
35-21	A	"				174. Pilot TP-31	13-5
35-22	S	"				175. Pilot TP-31	13-5
35-23	S	"				176. Pilot TP-31	13-5
35-24	H	"				177. Pilot TP-31	13-5
35-25	S	"				178. Pilot 173	13-15
35-26	S	"				179. Pilot T-131	13-11
35-28	S	"				180. Pilot T-370	15-5
35-29	S	"				181. Pilot 330	14-1
35-30	S	"				182. Pilot X-131	13-12
35-37	T	"				Pilot TV	
36 A	A	"	36	300	28		
36 AJ	A	"	36	300	29		
36 D	A	"					
36 H	A	"	36	300	45	Air King 72, 73	8-3
36 MB	A	"	36	300	33		
36 MC	A	"	36	300	33		
36 MD	A	"	36	300	36		
37 A	A	"	60	300	28	Web. Chicago AP-38	13-10
038 (.038)	A	"	60*	1100	7		
38 A	A	"			28		
40	A	USA	40	300	6		
40 A	A	"	40	300	28		
40-6E	A	"	60-18.0	4250			
40A1	A	"	20-60	70-95	22		
40A2	A	"	40	300	11	Equiv. to KX42C	
40B1	A	"	40				
40B2	A	"	40	300	11/33		
40 W	A	"	42	300	6	Equiv. to KX42A	
40X300	A	"	42	300	6	" " "	
41-7E	S	"					
042 (.042)	A	"					
42 A	A	"	42	300	6/28		
42 AJ	A	"					
42A1	A	"	42	300	39	Equiv. to KY42A	
42A2	A	"	42	300	40	" " KY42B	
42B2	A	"	42	300	40	" " KY42C	
42 H	A	"	42	300	45	Air King 260	8-4
42 HA	A	"	42	300	45	Air King 600	7-10
43X106	A	"				149. Sea Pal. (Marine Port.)	13-1
43X114	A	"				150. Mont. Ward 14 WG	14-33,34
43X215	H	"				151. Mont. Ward 64 WG	15-78
43X216	H	"				200. Western Auto D3615	20-31
45.41	A	"				148. Allied D-175	14-24
45-4001	A	"				See Chart 3.	
45-4001-2	A	"				" " "	
45-4004-2	A	"				" " "	
45 W	A	"	46	300	6	Equiv. to KI46A	
46A1	A	"	46	400	15	Majestic Ch. 400	3-42
46B1	A	"	46	300	15	" Ch. 400A	4-10
48A1	A	"	48	400			
48A2	A	"	48	300			
48B1	A	"	48	300			
48B2	A	"	48	300			
49 A	A	"	49	300	6/28	GE GD-60	10-3
49A1	A	"	49	300	39		
49A2	A	"	49	300	40		
49AJ	A	"	49	300	29		
49 B	A	"	49	300	33		
49B2	A	"	49	300	40		

Type	Use	Manuf.	Volt.	MA.	Base	Notes	Rider's Refer.
49 C	A	USA	49	300	33		
49 H	A	"	49	300	45		
49 XA	A	"	49	300	28		
49 KB	A	"	49	300	33		
49 KC	A	"	49	300	33		
49 KD	A	"	49	300	36		
49 LB	A	"	49	300	33		
49 LC	A	"	49	300	33		
49 LD	A	"	49	300	36		
49 W	A	"	49	300			
50	A	USA	50	300	6	Equiv. to XX49A	
50 A	A	"	50	300	28		
50A1	A	"	50	300	54	Zenith A-600, B-600	
50A2	A	"	50	300	11/33	Champion 50A2M	8-3
50A2MG	A	"	50	300	24	Equiv. to KZ49C	
50-AB	A	"	Universal Repl. Type			See Chart 4,	
50B2	A	"	50	300	11/33	Zephyr RCD	10-1
50B2MG	A	"	50	300	24	Equiv. to KZ49B	
50 MG	A	"	50	300	22	" " KZ49A	
50 W	A	"	49	300	6	" " XX49A	
50X3	A	"	50	300	11	Freed 351	6-1
50X3T	A	"	55	300	11		
50X300	A	"	55	120 300	6		
52	B	"	1.0*	120	10	Sears 7090	4-17
52 H	A	"	52	300	45	Air King 27	7-8
55-1		"	1.5-2.0	5750			
55-4		"	4.0-8.0	6250			
55 A	A	"	55	300	28	Goodyear 015040	10-35
55A1	A	"	55	300	39	Halsen MC-5	7-1
55A2	A	"	55	300	40		
55 AJ	A	"	55	300	29		
55 B	A	"	55	300	33		
55B2	A	"	55	300	40	Sears 7166	7-63
55 H	A	"	55	300	45		
55 KA	A	"	55	300	28		
55 KB	A	"	55	300	33	Trav-ler 501	10-10
55 KC	A	"	55	300	33		
55 LB	A	"	55	300	33	Warwick 520	7-3
55 LC	A	"	55	300	33		
55 LP	A	"	55	300	44		
55 LH	A	"	55	300	45		
55 MB	A	"	55	300	33		
55 MC	A	"	55	300	33		
55 MD	A	"	55	300	36		
60-92-1, 2, or 3	A	USA	Universal Repl. Type			See Chart 3.	
60-92-A, E, or F	A	"	"	"	"		
60R30	A	"	18	300	11	International Radio 77	7-3
61 A	A	"	61	300	28		
61 AJ	A	"	61	300	29		
61 KB	A	"	61	300	33		
61 KC	A	"	61	300	33		
61 LB	A	"	61	300	33		
61 LC	A	"	61	300	33		
61 LD	A	"	61	300	36		
61 MB	A	"	61	300	33		
61 MC	A	"	61	300	33		
62 A	A	"	62	300	28	Belmont 520 Serial A	10-6
64.23	A	"					
65R4	A	"	19	300	11	Clinton 620 1P	
67 A	A	"			28		
67 AJ	A	"			29		
67 KB	A	"	67	300	33		
67 KC	A	"	67	300	33		
67 KD	A	"	67	300	36		
69+2027	A	"					
69+2028	H	"					
69+2033	A	"	49	300	33	Equiv. to LA9B	
69+2037	A	"	42	300	33	" " LA2C	
70	R	USA	30-60	900	1		
72B2	A	"					
74 A	A	"			28		
74 AJ	A	"			29		
74 KA	A	"	74	300	28		
74 KB	A	"	74	300	33		

Type	Use	Manuf.	Volt.	MA.	Base	Notes	Rider's Refer.
74 KC	A	USA	74	300	33		
74 KD	A	"	74	300	36		
75	A	"					
75B2	A	"					
77/100	A	"					
77-109	A	"					
77-126	A	"					
77-127	A	"					
77-128	A	"					
77-1B1	A	"					
79 A	A	"			28		
79 KB	A	"	79	300	33		
79 KC	A	"	79	300	33		
80		USA					
80A	A	"			6/28		
80A1	A	"	80	300	27		
80A2	A	"	80	300	27		
80AJ	A	"			29		
80B2	A	"	80	300	27		
80F	A	"	80	300	44g	Air King 214	B-8
80H2	A	"	80	300	27e		
80LA	A	"	24	300	11		
80LB	A	"	24	300	11		
80LB	A	"	80	300	33		
80LC	A	"	80	300	33		
80R	A	"	24	300	6		
80R4	A	"	24	300	11		
80R8	A	"	24	300	11		
82A	A	"			28		
82 LB	A	"	82	300	33		
85L75CC		"					
85 LC	A	"	85	300	33		
85 LD	A	"	85	300	36		
85R8	A	"	25	300	11		
86A	A	"			28		
86A1	A	"	86	300	27		
86A2	A	"	86	300	27		
86 AJ	A	"			29		
86B2	A	"	86	300	27		
86 KB	A	"	86	300	33		
86 KC	A	"	86	300	33		
86 KD	A	"	86	300	36		
88A	A	"			28		
89M15822		"					
90	R	"	30-60	1400	1		
90A	A	"	27	300	28		
90AJ	A	"	27	300	29		
90F	A	"	90	300	44	Air King 22, 81	8-2
90RB	A	"	27	300	11		
92-7		"					
92-105-1	A	"	Universal Repl. Type			See Chart J.	
92-105-A	A	"					
92A	A	"			28		
92A1	A	"	92	300	27		
92A2	A	"	92	300	27		
92B2	A	"	92	300	27		
92 KB	A	"	92	300	33		
92 KC	A	"	92	300	33		
92 KD	A	"	92	300	36		
93-8		"					
94-5		"					
94RB	A	"	28	300	11		
95K2 (K42C)	A	"	42	300	33	54. RCA 87 EY	9-79
98 (D-98)	R	"	30	980	?		
98A	A	"			28		
98AJ	A	"			29		
100	R	USA	30	1000	?		
100+37	A	"	49	300	42	Zenith Ch. 5633	7-10
100+38	A	"	42	300	42	Zenith Ch. 5707	7-11, 18
100-40	S	"	56	300	49	Zenith Ch. 5633	7-10
100-41	S	"	81	300	49	Zenith Ch. 5633	7-10
100+45	A	"	51	300	42	Zenith Ch. 5707	7-18
100+46	A	"	76	300	42	Zenith Ch. 5707	7-18
100+47	S	"	126	300	49	Zenith Ch. 5707	7-18
100+48	H	"	146	300	49	Zenith Ch. 5707	7-18

Type	Use	Manuf.	Volt.	MA.	Base	Notes	Rider's Refer.
100-49	S	USA	176	300	49	Zenith Ch. 5707	7-10
100-52	B	"	Equiv. to 102		17	Zenith Ch. 5407	8-2
100-53	B	"	Equiv. to 182		17	Zenith Ch. 5518	8-4
100-55	A	"	57	300	49	Zenith Ch. 5639	8-15
100-56	S	"	82	300	49	Zenith Ch. 5639	8-15
100-57	S	"	107	300	49	Zenith Ch. 5639	8-15
100-58	S	"	132	300	49	Zenith Ch. 5639	8-15
100-59	S	"	152	300	49	Zenith Ch. 5639	8-15
100-60	S	"	182	300	49	Zenith Ch. 5639	8-15
100-61	A	"	51	300	49	Zenith Ch. 5710	8-25
100-62	A	"	76	300	49	Zenith Ch. 5710	8-25
100-63	S	"	101	300	49	Zenith Ch. 5710	8-25
100-64	S	"	126	300	49	Zenith Ch. 5710	8-25
100-65	S	"	146	300	49	Zenith Ch. 5710	8-25
100-66	S	"	176	300	49	Zenith Ch. 5710	8-25
100-68	B	"	1.0	420	6	Zenith Ch. 5408	8-3
100-69	B	"	1.0	660	6	Zenith Ch. 5522	8-5
100-70	A	"	49	300	42	Zenith Ch. 5657	10-17
100-72	S	"				Zenith Ch. 5713T	
100-73	S	"				Zenith Ch. 5713T	
100-74	S	"	64	300	49	Zenith Ch. 5646	9-4
100-76	A	"	70	150	39	Zenith S-7000	11-6
100-77	A	"	20	150	30	Zenith Ch. 5659	11-7
100-79	A	"	5	150	30	Zenith Ch. 5661	11-10
100-81	A	"	11	150	28	Zenith Ch. 5809T	
100-82		"				Zenith Ch. 1006T	
100-83	S	"	32	150	30	Zenith Ch. 5659	
100-84	S	"				Zenith Ch. 5722T	
100-85	S	"		150		183. Zenith Ch. 5C60T	15-10
100-86		"				Zenith Ch. 7A05	
100-87	S	"		150		184. Zenith Ch. 5C60T	15-10
100-89	S	"		150		185. Zenith Ch. 5C60T	15-10
100-91	S	"		150		186. Zenith Ch. 5C60T	15-10
100A					28		
100L4	A	"	30	300	11		
100L8	A	"	30	300	11		
100R		Tung.	50-70	100	82	231.	
100R	A	USA	30	300	6		
100R4	A	"	30	300	11		
100R8	A	"	30	300	11		
101		"				International Radio 950	9-5
102-D	H	"	102	300	36		
105 (D-105)	R	"	30	1050	7	Bremer-Tully 81-A	1-5
105	R	Viss.	20*	1150	79		
105A	H	USA	105	300	28		
105 KC	H	"	105	300	33		
105 KD	H	"	105	300	36		
105M4	A	"	32	300	11		
106	R	"	30	1060	7		
110 (D-110)	R	"	30	1100	7	Bremer-Tully 83, 84	
112	B	"	1.0	500	5	See Chart 7.	
114.14		"					
114.15		"					
114.16		"					
114.17		"					
114.18		"					
114.19		"					
114.20		"					
114.21		"					
114.22		"					
114.23		"					
114.24		"					
114.25		"					
114.26		"					
114.27		"					
114.28		"					
114.40		"					
114.41		"					
114.42A		"					
114.43		"					
114.43X		"					
114.44		"					
114.46		"					
114.47X		"					
114.49		"					

Type	Use	Manuf.	Volt.	MA.	Base	Notes	Rider's Refer.
115.1		USA					
115-1S		"					
115v14	A	"	49	300	33	Fada 20	9-1
115v15	"	"					
115v16	"	"					
115v17	H	"	100	300		31. Fada 211	7-3
115v18	H	"				41. Fada 211B	8-3
115v19	H	"				42. Fada 216	8-5
115v20	"	"					
115v21	"	"					
115v22	A	"	55	300	36	50. Fada 352	9-4
115v23	A	"	55	300	33	Fada 450	9-14
115v24	H	"				43. Fada 216	8-7
115v25	H	"				44. Fada 216	8-7
115v26	H	"				39. Fada 211	8-2
115v27	H	"				40. Fada 211	8-2
115v28	A	"	49	300	36	38. Dictograph 91168	8-3
115v40	A	"	55	300	28	Fada 350	8-23
115v41	A	"	49	300	33	16. Fada 60	10-9
115v42	A	"	32	300	36	Equiv. to BK32D	
115v42A	A	"	29	300	25	51. Fada 390	9-9
115v43	H	"					
115v43X	H	"					
115v44	H	"					
115v46	H	"					
115v47	H	"	162	300	36	Fada 370	9-7
115v47X	H	"					
115v49	H	"	142	300	25	Fada 390	9-9
115v53	A	"	55	300	33	Fada P-50	11-3
115.53X	"	"					
115.55	A	"	41	300	36	Fada 470	10-17
115.58	A	"	12	300		27. Fada 490	10-18
115.62	A	"	10	150	33	56. Fada 59	10-13
115.65	A	"	48	300	42	Fada L 96	11-7
115v68	A	"	22	300		28. Fada 74 APC	11-13
115.70	H	"	127	300		99. Fada 169	12-10
115.78	A	"	47	300		7. Fada 63	11-8
115.79	H	"	157	300		8. Fada 63	11-8
115.82	A	"	85	300		29. Fada 913	12-14
115.84	H	"	72	300		30. Fada 913	12-14
115.85	S	"	114	150		97. Fada LW-36	12-5
115.89	A	"	49	300	23	17. Fada 153	12-7, 15
115.96	A	"	8	150	66	Fada 120	12-8
115.98	A	"	105	150		98. Fada D 175	12-12
115.104	A	"				205. Radio Wire Tel. JS-174	19-17
115.105	A	"				206. Radio Wire Tel. JS-174	19-17
115.109	A	"				187. Allied B-17106	14-58
115.110	H	"				188. Allied B-17106	14-58
117.24	A	"	31	300	33	Fada 790	19-1, 5
117A							
118	R	"	30	1180	7		
120	B	USA	1.2	125	5	SEE CHART 7.	
120L4	A	"	36	300	11		
120LB	A	"	36	300	11		
120R	A	"	36	300	6		
120R4	A	"	36	300	11		
120R8	A	"	36	300	11		
120RS	"	"				International Radio 845 10-1	
125	R	"	30	1250	7		
126 (D-126)	R	"	30	1260	7		
130	R	"	30	1300	7		
130v35	"	"					
130R	A	"	39	300	6		
130R4	A	"	39	300	11		
130R8	A	"	39	300	11		
135K1 (K49B)	A	"	49	300	33	120. RCA 86X	8-129
135K1A	A	"	49	300	42	52. RCA 86X4	9-75
135T380	"	"					
140	A	"	42	300	6		
140A (KX42A)	A	"	42	300	6		
140 KB	A	"	42	300	11/33		
140 KC	A	"	42	300	11/33		
140L4	A	"	42	300	11		
140LB	A	"	42	300	11		
140L44	A	"	42	300	12		
140 LB	A	"	42	300	11/33		

Type	Use	Manuf.	Volt.	MA.	Base	Notes	Rider's Refer.
140 LC	A	USA	42	300	11/33		
140 LD	A	"	42	300	12/36		
140 LR	A	"	42	300	11		
140M4	A	"	42	300	11		
140M8	A	"	42	300	11		
140R	A	"	42	300	6		
140R4	A	"	42	300	11		
140R8	A	"	42	300	11	Internat'l Radio 739	9-5
140R44	A	"	42	300	12		
145A	A	"	43	300	6		
149C	A	"	49	300	33#	Sonora PR-300	8-1
150	C	"	20	1500	7		
150R		Tung.	50-70	150	82	232.	
150R		USA	45	300	6		
155	R	"	20	1550	7		
155-20		"					
158	R	"	20	1600	7		
159		"					
160-32	A	USA					
160-36	A	"	55	300	33		
160-37	A	"					
160-40	A	"					
160-41	A	"					
160-42	A	"					
160-43	A	"					
160A	A	"			6		
160 KB	A	"	48	300	33		
160 LB	A	"	48	300	33		
160 LC	A	"	48	300	33		
160R	A	"	48	300	6		
160R4	A	"	48	300	11		
164	A	"					
165A	A	"	49	300	6		
165 KB	A	"	49	300	11/33		
165 KC	A	"	49	300	11/33		
165 KD	A	"	49	300	12/36		
165LA	A	"	49	300	11	Fairbanks Morse 68T8	8-25
165LB	A	"	49	300	11		
165LA44	A	"	49	300	12		
165 LB	A	"	49	300	11/33		
165 LC	A	"	49	300	11/33		
165 LD	A	"	49	300	12/36		
165M4	A	"	49	300	11		
165M8	A	"	49	300	11		
165R	A	"	49	300	6	Internat'l Radio KR-20	10-2
165R4	A	"	49	300	11	Internat'l Radio 96	7-2
165R8	A	"	49	300	11	Trav-ler 622	7-3
165R44	A	"	49	300	12		
168RB	A	"	50	300	11		
169		"					
170K1	A	"	51	300	33		
180A	A	"	54	300	6		
180 KB	A	"	54	300	11/33		
180 KC	A	"	54	300	11/33		
180 KD	A	"	54	300	12/36		
180R	A	"	54	300	6		
180R		Tung.	225*	180	82	237.	
185	A	USA	55	300	11	Bosch 05	6-20
185A	A	"	55	300	6/28		
185 KB	A	"	55	300	11/33		
185 KC	A	"	55	300	11/33		
185 KD	A	"	55	300	12/36		
185LA	A	"	55	300	11		
185LB	A	"	55	300	11	Firestone 7422-3	8-3
185LA44	A	"	55	300	12		
185LB	A	"	55	300	11/33		
185LC	A	"	55	300	11/33		
185LD	A	"	55	300	12/36		
185M4	A	"	55	300	11		
185M8	A	"	55	300	11		
185R	A	"	55	300	6		
185R4	A	"	55	300	11	Devald 506-R	6-7
185R8	A	"	55	300	11	Firestone 7422-3	8-3
185R44	A	"	55	300	12		
185XB	A	"	55	300			
190K1	A	"	57	300	28		
192A	A	"					

Type	Use	Manuf.	Volt.	MA.	Base	Notes	Rider's
200L4	A	USA	60	300	11		
200LB	A	"	60	300	11		
200R	A	"	60	300	6	Internat'l Radio 1030	9-9
200R I		Tung.	200*	200	66		
200R II		"	100*	200	66		
200R4	A	USA	60	300	11		
200R8	A	"	60	300	11		
201		GeMar.	200*	200	66		
202		Ceram	120-200	200	E2		
203		USA			7		
204		GeMar.	200*	200	66		
216		USA			7		
218	R	"	20	2200	7		
220	H	"	150	300		Lafayette C79, 80	7-5
220L4	A	"	66	300	11		
220LB	A	"	66	300	11		
220R	A	"	66	300	6		
220R4	A	"	66	300	11		
220R8	A	"	66	300	11		
220SX	H	"					
240L4	A	"	72	300	11		
240LB	A	"	72	300	11		
240R	A	"	72	300	6		
240R4	A	"	72	300	11		
240R8	A	"	72	300	11		
245A	A	"	73	300	6		
245 KA	A	"	73	300	28		
245 KB	A	"	73	300	11/33		
245 KC	A	"	73	300	11/33		
245 KD	A	"	73	300	12/36		
250A	A	"	75	300	6		
250 KB	A	"	75	300	11/33		
250 KC	A	"	75	300	11/33		
250 KD	A	"	75	300	12/36		
250L4	A	"	75	300	11		
250LB	A	"	75	300	11		
250M4	A	"	75	300	11		
250M8	A	"	75	300	11		
250R	A	"	75	300	6	Internat'l Radio 1030	9-9
250R4	A	"	75	300	11		
250R8	A	"	75	300	11		
250 T		"					
251		Ceram	100-180	250	82	241.	
260		USA					
260K1A	H	"	152	300	49	53. RCA 86X4	9-75
260L4	A	"	78	300	11		
260LB	A	"	78	300	11		
260R	A	"	78	300	6		
260R4	A	"	78	300	11		
260R8	A	"	78	300	11		
270 KB	A	"	81	300	11/33		
270 KC	A	"	81	300	11/33		
270L4	A	"	81	300	11		
270LB	A	"	81	300	11		
270M4	A	"	81	300	11		
270M8	A	"	81	300	11		
270R	A	"	81	300	6		
270R4	A	"	81	300	11		
270R8	A	"	81	300	11		
275	A	"					
280L4	A	"	84	300	11		
280LB	A	"	84	300	11		
280R	A	"	84	300	6		
280R4	A	"	84	300	11		
280R8	A	"	84	300	11		
300L4	A	USA	90	300	11		
300LB	A	"	90	300	11		
300R	A	"	90	300	6		
300R4	A	"	90	300	11	Internat'l Radio 1030	9-9
300R8	A	"	90	300	11		
301		Ceram	138-221	300	1		
302		"	112-195	300	1		
303		"	86-129	300	1		
304		"	95-165	300	1		
309-115	A	USA		300		55. Ultramar 309	9-2
313	R	"	30	1300	7		

Type	Use	Manuf.	Volt.	MA.	Base	Notes	Hider's Refer.
314	R	USA	30	1400	7		
315	R	"	30	1500	7		
320		Phil.	10-30	1150	1432		
320L4	A	USA	96	300	11		
320L8	A	"	96	300	11		
320R	A	"	96	300	6	Internat'l Radio 1030	9-9
320R3	A	"	96	300	11		
320R4	A	"	96	300	11	Internat'l Radio 1030	9-9
320R8	A	"	96	300	11		
320X4	A	"					
329		Phil.	28/28	1300/1100	79	222.	
340		"	3.0-10	5900	1		
340		USA	40	300	6	Air King 40	6-1
340L4	A	"	102	300	11		
340L8	A	"	102	300	11		
340R	A	"	102	300	6		
340R4	A	"	102	300	11		
340R8	A	"	102	300	11		
350R	A	"	105	300	6		
376	R	"				Replace with RCA 876	
380	R	"				Replace with RCA 886	
386	R	"					
400-240		USA					
400R	H	"	120	300	6		
410		"					
415	R	"	35#		9	Colin Kennedy 26	1-6
424-90	R	"					
425	R	"			7		
439	R	"					
444-90	R	"					
449	R	"	35		9	Colin Kennedy 826-B	1-12
452		Phil.	16/16	1300/1100	79	225.	
454		USA					
460		"					
464-90		"					
464-200		"					
484-90		"					
484-200		"					
495X1	H	"			49	121.	
501		Phil.	24	600/500	79	220.	
538	R	USA	38	1050	7		
571-606 (571606)	T	"				Emerson TV	
610-10 (CL-610-10)	R	"				Packard Bell 48	7-3
808-1	A	USA	35	300	42	Fairbanks Morse 9B	11-1, 2
808-2	A	"	60	300	49	Fairbanks Morse 9B	11-1, 2
808-4	H	USA	170	300	49	Fairbanks Morse 9B	11-1, 2
808-5		"					
838		"					
874R4B		"	23	300	13		
876	R	"	40-60	1700	1	10. RCA AP-947	1-2
877		"				RCA Radiola 25	1-4
878R4B	A	"	24	300	13	Inter. Radio 87 Series	7-5
886	R	"	40-60	2050	1	10. RCA AP-947-A	
886A	R	"	40-60	2000	7	Brunswick RPA-4A	1-25
887		"					
1003		Phil.	20-100	170	82		
1005		Photom.	20"	1150	79		
1011		Phil.	25/25/160		83	226.	
1012		"	6.0-18	5700	1/82		
1012		USA			3	Majestic PwrPak 886, 8P6	
1014		Phil.	42	500	79	224.	
1102		"	5-20/10-80		79	227.	
1111		"	2-12/10-80		79	228.	
1120		"	6.0-18	3200	82		
1130		"	10-40	480	82		
1210		USA			3	Majestic 90, 92, 100	
1331		Phil.	42	1300	79	223.	
1455		"	3.0-10	420	82		
1456		"	15-18/10-30		84	229.	
1457		"	6-22/4-12		84	230.	
1508	R	USA			3	Majestic PwrPak 7BP6 (1929)	
1516		"			3	Majestic PwrPak 7P6 (1928)	
1518		"	13	180	82		

Type	Use	Manuf.	Volt.	MA.	Base	Notes	Rider's Refer.
1900		Phil.	118-122	600	1		
1903		"	139-141	220	1		
1904 (T-1904)		"	50-70	100	82	231.	
1905		"	2.0-6.0	1000	1		
1908		"	5.0-15	800	1		
1909		"	15-45	620	82		
1910		"	4.5-14.5	1440	80/82		
1911		"	50-70	150	82	232.	
1912		"	90-230	140	82	233.	
1913		"	4.0-12	200	1		
1915		"	50-70	240	82		
1916 (Early Type)		"	4.0-10	1100	1		
1916		"	35	180	82		
1918		"	4.0-10	100	1		
1919		"	20-60	550	1		
1920		"	50-70	250	82	234.	
1921		"	20-60	1400	1		
1922		"	10-30	1800	1		
1923		"	10-30	430	1		
1924		"	100-240	1000	1		
1926		"	16-	180	82	235.	
1927		"	35-100	180	82	236.	
1928		"	100-225	180	82	237.	
1929		"	35-150	180	82	238.	
1930		"	19-21	180	82		
1931		"	12-36	2500			
1932		"	40-80	2500	1		
1933		"	50-150	100	82		
1934		"	85-180	250	82	241.	
1935		"	40-120	250	82		
1936		"	30-42	180	82		
1937		"	30-90	120			
1938		"	40-60	1700	82	239.	
1939		"	120-160	120			
1940		"	5.0-15	6000			
1941		"	80-200	300	82		
1943		"	40-60	2050	82	240.	
1945		"	80-120	275	66/82		
1947		"	2.0-6.0	500	1		
1949		"	30-90	300	82		
1950		"	30-90	950	1		
1952		"	30-60	700	1		
2005		Fotos.	30*	1150	80		
2169		USA			7		
2179		"			7		
2342		"					
2342-1	A	"				Melson 412	9-5
2408		"			7		
2518		"					
2600	A	"	55	300	28	Dewald 1100	7-11
2601	A	"	30	300	33	Dewald 1100	7-11
2903 (L55B)	A	"	55	300	33		
2904 (L55C)	A	"	55	300	33		
2905 (L49C)	A	"	49	300	33		
2906		"					
2911		"					
2916		"					
2917		"					
2918		"					
2919		"					
2922		"					
2923		"					
3035		USA					
3271		"					
3313		"					
3326 (BK42D)	A	"	42	300	36	Detrola	
3334	A	"	49	300	12/36		
3334A	A	"	49	300	12/36		
3340	S	"		300		197. Dewald 1104	9-10
3441	S	"		300		198. Dewald 1104	9-10
3485	H	"				68. Dewald 665	11-7
3613 (BK55B)	A	"	55	300	33		
3614		"					

Type	Use	Manuf.	Volt.	MA.	Base	Notes	Rider's Refer.
5001	R	USA			7	Stev. Warner 900	
5002	R	"			7	Stev. Warner 950	
5003	R	"			7	Stev. Warner R-100	
5184		"					
5459	H	"				9. Belmont 507A, 513A	11-5
5500	S	"	Shorting Plug			2. Equiv. to 3MZ-419	
5501		"				" " 18	
5502	A	"				" " 100-37	
5503	A	"				" " 100-38	
5504		"				" " 3271	
5505		"				" " 26871	
5506	A	"	42	300	45	" " 42 HA	
5507	A	"	50	300	24	" " 50A2 MG	
5508	A	"	50	300	24	" " 50B2 MG	
5509	A	"	55	300	33	" " 55 LB	
5510	A	"	42	300	11	Equiv. to 140R8	
5511		"				" " 155-20	
5512	A	"	49	300	11	" " 165R4	
5513	A	"	55	300	11	" " 185R8	
5514	A	"	23	300	33	" " BK23B	
5515	A	"	36	300	33	" " BK36B	
5516	A	"	42	300	33	" " BK42C	
5517	A	"	42	300	36	" " BK42D	
5518	A	"	49	300	36	" " BK49D	
5519	A	"	55	300	33	" " BK55B	
5520	A	"	36	300	33	Equiv. to BM36C	
5521	A	"	42	300	33	" " BM42C	
5522	A	"	49	300	33	" " BM49B	
5523	A	"	49	300	33	" " BM49C	
5524	A	"	55	300	33	" " BM55B	
5525	A	"	80	300	33	" " BM80B	
5526	R	"				" " CL-610-10	
5527	A	"	24	300	33	" " K24C	
5528	A	"	38	300	41	" " K38B2	
5529	A	"	55	300	38	" " K55CP	
5530	A	"	42	300	33	Equiv. to K42C	
5531	A	"	42	300	43	" " K42E	
5532	A	"	43	300	33	" " K43B	
5533	A	"	49	300	33	" " K49B	
5534	A	"	49	300	33	" " K49C	
5535	A	"	55	300	33	" " K55B	
5536	A	"	55	300	33	" " K55C	
5537	A	"	67	300	33	" " K67B	
5538	A	"	74	300	33	" " K74C	
5539	A	"	80	300	33	" " K80B	
5540	A	"	87	300	33	Equiv. to K87B	
5541	A	"	92	300	28	" " K92A	
5542	A	"	95	300	33	" " K95B	
5543	A	"	42	300	41	" " KY42D	
5544	A	"	40	300	33	" " L40C	
5545	A	"	40	300	33	" " L40S	
5546	A	"	40	300	37	" " L40S2	
5547	A	"	42	300	33	" " L42B	
5548	A	"	42	300	33	" " L42C	
5549	A	"	42	300	36	" " L42D	
5550	A	"	49	300	33	Equiv. to L49B	
5551	A	"	49	300	42	" " L49BJ	
5552	A	"	49	300	33	" " L49C	
5553	A	"	49	300	21	" " L49DJ	
5554	A	"	49	300	33	" " L49E1	
5555	A	"	55	300	33	" " L55B	
5556	A	"	55	300	33	" " L55C	
5557	A	"	55	300	37	" " L55S1	
5558	A	"	55	300	37	" " L55S2	
5561	A	"	80	300	33	Equiv. to L80B	
5562	A	"	42	300	33	" " M42B	
5563	A	"	49	300	33	" " M49B	
5564	A	"	47	300		36. " " W-42520	
5565		"				" " W-43506	
5566	S	"				49. " " W-44338	
5567	A	"	49	300	36	" " L49D	
5571		"					
5574		"					
5576		"					
5577		"					
5579		"					
5580		"					

Type	Use	Manuf.	Volt.	MA.	Base	Notes	Rider's Refer.
6003		Fotos.	18*	5700	1		
6310	R	USA					
6412	R	"	35	970	3	Grebe SK-4 (114V.line)	
6420	R	"	60	970	3	Grebe Sk-4 (138V.line)	
6465	A	"				124.	
8589		USA					
8593	A	"	49	300	33	Equiv. to M49B	
8595	A	"	55	300	33	" " L55B	
8598	A	"	55	300	33	" " L55B	
8600	S	"					
8601	A	"	55	300	33	" " M55E1	
8663	A	"	42	300		Dewald 1102-3	10-6
8664 (L55E1)	A	"	55	300	33	Dewald 1102-3	10-6
8850		"					
8853	A	"	65	300		Dewald 532	10-3
8917		"					
9941		USA				MarconiPhone D-10 (1938)	10-4
10077	A	USA	42	300	33	Equiv. to BK42C	
10079	A	"	42	300	36	" " BK42D	
10233	A	"	5	300	28	Sentinel 139 UE	10-55
10234	H	"	120	300	28	Sentinel 139 UE	10-55
11222	A	"	10	150		92. Sentinel 184 U	11-17
11223	H	"	125	150		93. Sentinel 184 U	11-17
16032 (K60C)	A	"	60	300	33	Majestic 50	8-1
16035	A	"	45	300	33	Majestic 60	8-2
16036 MG	A	"	49	300	33	Majestic 60	8-2
16037 (A-16037)	A	"	17	300	43	Majestic 800	8-7
16039	A	"					
16040 (A-16040)	A	"	49	300	33	Equiv. to K49C)	
16041 (A-16041)		"					
16042 (A-16042)		"					
16043 (A-16043)		"					
16054		"					
26871		USA					
27287 (P-27287)	A	"	49	300	33	207.	
28602		"					
29004	A	"				4.	
29338	A	"				5.	
29729	A	"				6.	
30971	S	"				152. Westinghouse M-110	13-15
30972	S	"				153. Westinghouse M-110	13-15
31577	S	"				13. RCA 98T2	11-113.
32544	A	"	49	300	42	Equiv. to BK49BJ	
35000	A	"	110	150		22.	
38710		"					
45788 (W-45788)	A	"	80	300	28	23.	
47303		"					
61816	R	USA			3	Stew. Warner 900-1,2,3	1-7
62151	R	"			3	" " 900-1,2,3	"
62152	R	"			3	" " 950-1,2,3	1-6
62154	R	"			3	" " 900-1,2,3	1-7
66412	R	"			3	" " 910-1,2,3	
66491	R	"			3	" " 950-1,2,3	1-6
66514	R	"			3	" " 990-1,2,3	
66547	R	"			3	" " 900-1,2,3	1-7
66756	R	"			3	" " R-100-A	1-10
66841	R	"			3	" " R-100-B	1-10
68852	H	"			3	" " R-100-E	1-110
69116	A	"	49	300	36	Equiv. to K49D	
72308	H	USA				199. RCA Q103	16-8
81963	A	"	30	300	46	46. Pilot 423	9-7
81966 (81966-2)	A	"	47	300	33	" " G-162	8-9
81967	H	"				45. " G-162A	8-10
81971	A	"				62. " H-372	10-7
81972	H	"				63. " H-373	10-7
81973	A	"				61. " H-224	10-5
81974	A	"	55	300		59. " H-141	10-4
81975	H	"	170	300		60. " H-141	10-4
81976	S	"				64. " TH-150	10-9
81985	A	"	47	300		65. " T-1252	10-25
81988	A	"				81. " T-1584	11-8

Type	Use	Manuf.	Volt.	MA.	Base	Notes	Rider's Refer.
81989	S	USA				82. Pilot T-1584	11-8
81990	S	"				83. " T-1584	11-8
81991	H	"				84. " T-1584	11-8
81996	"	"					
84147	S	"				111. Pilot T-1164	12-11
84152	S	"				76. " T-1264	11-5
84364	H	"				112. " T-1164	12-11
84428	S	"	Shorting	Plug		113. " X-1252	12-11
84429	S	"				114. " X-1252	12-11
84430	S	"				115. " X-1252	12-11
84431	S	"				116. " X-1252	12-11
84445	S	"				77. " X-1584	11-7
84446	S	"				78. " X-1584	11-7
84447	S	"				79. " X-1584	11-7
84448	S	"				80. " X-1584	11-7
84650	S	"				72. " T-101	11-1
84651	S	"				73. " T-101	11-1
84652	S	"				74. " T-101	11-1
84653	S	"				75. " T-101	11-1
84821	S	"				107. " 191	12-7
84822	S	"				108. " 191	12-7
84823	S	"				109. " 191	12-7
84824	S	"				110. " 191	12-7
86892-1	A	"			21	126. RCA	13-14
86892-2	H	"			20	127. RCA	13-14
86892-3	S	"			21	128. RCA	13-14
86892-4	S	"			SP	89. RCA 6Q4X	11-27
86892-6	H	"				129. RCA	13-14
86892-7	H	"				130. RCA	13-14
86892-8	H	"			33	131. RCA	13-14
86892-9	H	"	110	150		11. RCA 46X21, 22, 24	11-86
95001		Phil.	2.5-7.5	1100	1		
95002		"	6.0-12	600	2		
95003		"	2.0-6.0	1600	1		
95004		"	1.0-7.0	550			
95006		"	1.8-4.2	640	2		
95007		"	5.5-12.5	640	2		
95008		"	3.5-10.5	800	1		
95009		"	0.5-1.5	600	2		
95010		"	30-90	350	1		
95011		"	40-80	700	1		
95012		"	5.0-15	1000	1		
95017		"	3.0-9.0	720	2		
95019		"	15-45	400	2		
95020		"	14-26	600	2		
160540	A	USA	45	150	28	Firestone S-7401-7 Phono-osc.	12-1
397021	T	USA				243. Emerson TV	
397022	T	"				244. " "	
397023	T	"				245. " "	
397036	T	"				246. " "	
407100	T	USA				Electromatics TV	
408100	T	"				" TV	
507300 (SW507300)	T	USA				Stewart Warner TV	
571606 (571-606)	T	USA				Emerson TV	
920117-1	H	USA				137. RCA	13-14
922337-1	"	"					

NOTES

1. BKV51DJ 5 prong base.
2. JM2-419 Octal base. Shorting plug for 105-125 V. line.
3. M-86892-11 Octal base.
4. 29004 Octal base. Clarostat
5. 29338 Octal base. Clarostat
6. 29729 Octal base. Clarostat
7. 115.78 Octal base. For 110 V. line.
8. 115.79 Octal base. For 220 V. line.
9. 5459 Octal base.
10. Base fits standard mogul screw socket. Unit operates at high temperature (150°F.) so adequate ventilation is required, and must be surrounded by a protective metal ventilation stack.
11. 86892-9 Octal base. RCA
12. M-86892-9 Same as Note 11.
13. 31577 This is an RCA stock no. for K-83747-6. See Note 122.
14. WW48 Octal base. Same as M-86892-6
15. W-46416 Octal base. Equivalent to K55B.
16. 115.41 Octal base. or
17. 115.89 Octal base.
18. NB2 Octal base. At 360 MA, volt. drop 1 to 3 = 0.6 V.
1 to 5 = 1.0 V.
19. P6B Octal base.
20. K55 Octal base. One pilot lamp across 6 & 7.
21. W-46773 Octal base. Equivalent to K49B.
22. 35000 This is an RCA stock no. for M-86892-9. See note 12.
23. W-45788 Octal base. Equivalent to K80A
24. L49E May also be this:
25. R3003 Octal base. One pilot lamp across 3 & 5. 6 V. - 250 MA
26. 17AJ Octal base.
27. 115.58 Octal base.
28. 115.68 Octal base. 115 V. line
29. 115.82 Octal base. 120 V. line
30. 115.84 Octal base. 220 V. line
31. 115.17 Octal base. 115 V. line
32. C4B Octal base. For 120V., strap term. 4 & 7. For 240V. open
33. D5B Octal base.
34. D14B Octal base.
35. D14BS Octal base.
36. W-42520 Octal base.
37. W-41187 Octal base. Special unit used by Crosley for tone control.
38. 115.28 Octal base. Equivalent to K49D.
39. 115.26 Octal base.
40. 115.27 Octal base.
41. 115.18 Octal base.
42. 115.19 Octal base.
43. 115.24 Octal base.
44. 115.25 Octal base.
45. 81967 Octal base.
46. 81963 Octal base. Equivalent to L30J.
47. C5B/D6B Octal base.
48. E6B Octal base.
49. W-44338 Octal base.
50. 115.22 Octal base.
51. 115.42A Octal base.
52. 135K1A Octal base. 110 V. line

53.	260K1A	Octal base.		See Rider's RCA 13-14
54.	95X2	Octal base.		Equivalent to BK42C
55.	309-115	Octal base.		
56.	115.62	Octal base.		
57.	D-9085	-----		
58.	E-658-A	Octal base.		
	E-658-B	Octal base.		
59.	81974	Octal base.		115 V. line
60.	81975	Octal base.		230 V. line
61.	81973	Octal base.		
62.	81971	Octal base.		115 V. line
63.	81972	Octal base.		230 V. line
		May also be:		
64.	81976	Octal base.		150 V. line
65.	81985	Octal base.		115 V. line
66.	E-5748	Octal base.		
67.	G-30-50	Octal base.		115 V. line
68.	3485	Octal base.		220 V. line
69.	BR-782	Octal base.		
70.	BKU172B	6 Prong base.		Used on 100-130 V. or 200-260 V. line w/changeover plug.
71.	BKU126D	6 Prong base.		Used on 100-130 V. or 200-260 V. line w/changeover plug.
72.	84650	Octal base.		117 V. line
73.	84651	Octal base.		130 V. line
74.	84652	Octal base.		150 V. line
75.	84653	Octal base.		230 V. line
76.	84152	Octal base.		130 V. line
77.	84445	Octal base.		117 V. line
78.	84446	Octal base.		130 V. line
79.	84447	Octal base.		150 V. line
80.	84448	Octal base.		230 V. line
81.	81988	Octal base.		115 V. line
82.	81989	Octal base.		130 V. line
83.	81990	Octal base.		150 V. line
84.	81991	Octal base.		230 V. line
85.	K-85277-3	Octal base.		200-250 V. line
86.	K-85277-4	Octal base.		220 V. line
87.	K-85277-5	Octal base.		210-250 V. line
88.	K-83747-3	Octal base.		110 V. line
89.	M-86892-4	Octal base.		
			This unit is used in a 3 pos. socket to operate at 105-125 V., 160-190 V., or 210-250 V.	
90.	M-91462-1	12 pin base.		
		This system also used:		
		This unit is used in a special 3 pos., 12 pin socket to operate at 117 V., 180 V., or 230 V..		

91.	M-86892-10	Octal base.		
92.	11222	Octal base.		115 V. line
93.	11223	Octal base.		220 V. line
94.	8XR-432	Octal base.		Shorting plug for 105 - 125 V. line
95.	8XR-433	Octal base.		220-250 V. DC line.
96.	8XR-434	Octal base.		220-250 V. AC line.
97.	115.85	Octal base.		235 V. line
98.	115.98	Octal base.		120 V. line
99.	115.70	Octal base.		
100.	6.159	Octal base.		
101.	K13J567	Octal base.		
102.	RR-790 (K-26J307)	Octal base.		220 V. line
103.	35-2	Octal base.		117 V. line
104.	35-3	Octal base.		130 V. line
105.	35-4	Octal base.		150 V. line
106.	35-5	Octal base.		230 V. line
107.	84821	Octal base.		117 V. line
108.	84822	Octal base.		130 V. line
109.	84823	Octal base.		150 V. line
110.	84824	Octal base.		230 V. line
111.	84147	Octal base.		130 V. line
112.	84364-2	Octal base.		230 V. line
113.	84428	Octal base.		Shorting plug for 110 - 125 V. line
114.	84429	Octal base.		130 V. line
115.	84430	Octal base.		150 V. line
116.	84431	Octal base.		230 V. line
117.	M-91462-2	12 pin base.		
This unit is used in a special 3 pos. 12 pin socket to operate at 117 V., 180 V., or 230 V..				
118.	MT-300	Octal base.		
119.	MT-650	Octal base.		
120.	135K1	Octal base. RCA		Equivalent to 8K42B.
121.	495K1	Octal base. RCA		
122.	K-83747-6	Octal base. RCA		
123.	-B	Octal base.		
124.	6465-110V.	Octal base.		
125.	BE10663	6 prong spec. Wards		For 110 V. or 220 V. line. Tube turned 180° for one or the other.
126.	M-86892-1	Octal base.		
127.	M-86892-2	Octal base.		
128.	M-86892-3	Octal base.		
129.	M-86892-6	Octal base.		Same as W448
130.	M-86892-7	Octal base.		
131.	M-86892-8	Octal base.		

132.	M-91462-3	12 pin base.		
				This unit is used in a special 3 pos. 12 pin socket to operate at 117 V., 180 V., or 230 V..
133.	M-91462-5	12 pin base.		
				This unit is used in a special 2 pos. 12 pin socket to operate at 117 V. or 230 V..
134.	M-91462-6	Octal base.		
135.	M-91462-7	Octal base.		
136.	M-91462-8	Octal base.		
137.	M(X)-920117-1	Octal base.		
138.	M-920146-1	Wire in type.		
139.	M-95178-7	Octal base.		140 - 160 V. line
140.	M-95178-8	Octal base.		160 - 200 V. line
141.	M-95178-9	Octal base.		260 - 300 V. line
142.	M-95178-10	Octal base.		115 or 230V. line
143.	W-32351	Octal base.		220 V. line
144.	W-32353	Octal base.		110 V. line
145.	M-85277-3	Octal base.		
146.	M-85277-4	Octal base.		
147.	M-85277-5	Octal base.		
148.	45.41	Octal base.		
149.	43X106	Octal base.		
150.	43X114	Octal base.		
151.	43X215	Octal base.		
152.	30971	Octal base.		120 - 130 V. line
153.	30972	Octal base.		130 - 150 V. line
154.	RRB-001	Octal base.		230 V. line
155.	RRB-002	Octal base.		120 V. line
156.	RRB-003	Octal base.		
157.	RR-783	Octal base.		
158.	RR-797	Octal base.		220 V. line
159.	RR-798	Octal base.		110 V. line
160.	RR-799	Octal base.		150 V. line
161.	RR-7003	Octal base.		200 - 240 V. line
162.	RR-7004	Octal base.		160 - 200 V. line
163.	RR-7005	Octal base.		117 V. line
164.	RR-7007	Octal base.		200 - 240 V. line
165.	RR-7008	Octal base.		145 - 215 V. line
166.	35-9	Octal base.		117 V. line
167.	35-10	Octal base.		130 V. line
168.	35-11	Octal base.		150 V. line
169.	35-12	Octal base.		230 V. line
170.	35-13	Octal base.		117 V. line
171.	35-14	Octal base.		130 V. line
172.	35-15	Octal base.		150 V. line
173.	35-20	Octal base.		115 or 230V. line

174.	35-21	Octal base.		117 V. line
175.	35-22	Octal base.		130 V. line
176.	35-23	Octal base.		150 V. line
177.	35-24	Octal base.		220 V. line
178.	35-25	Octal base.		115 or 230V. line
179.	35-26	Octal base.		
180.	35-28	Octal base.		
181.	35-29	Octal base.		115 - 230 V. line
182.	35-30	Octal base.		115 or 230V. line
183.	100-85	Octal base.		115 or 230V. line
184.	100-87	Octal base.		150V. line
185.	100-89	Octal base.		175V. line
186.	100-91	Octal base.		200V. line
187.	115-109	Octal base.		120V. line
188.	115-110	Octal base.		220V. line
189.	10UR-511	Octal base.		225V. line
190.	10UR-570	Octal base.		115V. line
191.	33-3391	Octal base.		115 or 230V. line
192.	33-3414	Octal base.		115 or 230V. line
193.	11.3	Octal base.		
194.	6.170	Octal base.		117V. line
195.	6.171	Octal base.		235V. line
196.	6.173	Octal base.		
197.	3440			
198.	3441			
199.	72308	Octal base.		220V. line
200.	43X216	Octal base.		
201.	MS41	Octal base.		
202.	24B856	Octal base.		Use at 110V. or 220V. by rotating 180°.
203.	24B874	Octal base.		220V. line
204.	24B875	Octal base.		120V. line
205.	115.104	Octal base.		120V. line
206.	115.105	Octal base.		220V. line
207.	P-27287 (27287)	Octal base.		Equivalent to L49E1
208.	JER-249	Octal base.		This is a 300 MA. ballast with an overall voltage drop of 249 V. using 2 lamps of 200 or 250 MA. rating.
209.	JMR-253	Octal base.		Perforated metal case.
210.	10T1	Octal base.		
211.	17A470303	Octal base.		
212.	17A485459	Octal base.		
213.	4SR-211	Octal base.		Used on 32 V. DC line.
214.	C-9266	Octal base.		
215.	E 157	Octal base.		
216.	EW 120			Each section is 3.07-9.0 V. drop at 1300 MA.
217.	EW 121			Each section is 3.0-24 V. drop at 1400 MA.
218.	EW 130.			Each section is 25-75 V. drop at 100 MA.







219. EV 131 Each section is 25-75 V. drop at 60 MA.
220. WE 22 and 501 are the same except different manufacturers.
221. WE 33 Each section has a 24 V. drop, one at 1100 MA., the other at 800 MA.
222. WE 44 and 329 are the same except different manufacturers. Each section has a 28 V. drop, one at 1300 MA., the other at 1100 MA.
223. WE 45 and 1331 are the same except different manufacturers. Each section has a 42 V. drop at 1300 MA.
224. WE 46 and 1014 are the same except different manufacturers. Each section has a 42 V. drop at 500 MA.
225. WE 55 and 452 are the same except different manufacturers. Each section has a 16 V. drop, one at 1300 MA., the other at 1100 MA.
226. WE 34 and 1011 are the same except different manufacturers. Two sections each have a 25 V. drop at 1150 MA. The third section has a 160 V. drop at 180 MA.
227. 1102 One section has a max. 20 V. drop at 2000 MA. The other section has a max. 80 V. drop at 600 MA.
228. 1111 One section has a max. 12 V. drop at 2000 MA. The other section has a max. 80 V. drop at 600 MA.
229. 1456 One section has a max. 18 V. drop at 1300 MA. The other section has a max. 30 V. drop at 250 MA.
230. 1457 One section has a max. 22 V. drop at 1180 MA. The other section has a max. 12 V. drop at 690 MA.
231. 100R, 1904, RR 100, V 60, WE 15, and W1 100 are the same except diff. manufacturers.
232. 150R, 1911, and W1 150 are the same except different manufacturers.
233. 1912 and V 80 are the same except different manufacturers.
234. 1920 and W1250 are the same except different manufacturers.
235. 1926 and RR 180 are the same except different manufacturers.
236. 1927, RR 1180, V 100, and W1 180a are the same except different manufacturers.
237. 1928, 180R, RR 2180, V 150, and W1 180b are the same except different manufacturers.
238. 1929 and V 180a are the same except different manufacturers.
239. 1938 and W1 V 1700 are the same except different manufacturers.
240. 1943 and W1 V 2000 are the same except different manufacturers.
241. 251 and 1934 are the same except different manufacturers.
242. W1 to W4 Caras. These are an Urdox type tube with a built in filament heater control. This heater will change the ballast resistance according to its operating voltage, but is standardized at 4.0 V.-0.78 A.
243. 397021 Octal base. 
244. 397022 Octal base. 
245. 397023 Octal base. 
246. 397036 Octal base. 
247. PB 57 Octal base. 
248. W-28864 B 
249. W-29953-A 

Chart No. 1

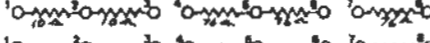
Standard RMA Designation Code

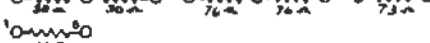
Ballast tubes in this category are designated by one or two letters, a number, followed by another letter or two.

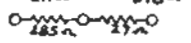
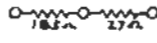
Examples: K55B BL49CG M67A

The letter B (if used at the beginning) indicates a 'Ballast Action' or 'True Ballast' on the pilot light section.

The next letter indicates the current rating of the pilot lamp(s) used.

K = 6.3V-150 MA (Brown bead) #40, 47, or 1847

L = 6.3V-250 MA (Blue bead) #44 or 46

M = 6-8V-200 MA (White bead) #50 or 51

The number indicates the total voltage drop produced by the ballast including the pilot lamp(s), with 300 MA of current.

The next letter indicates the type of base wiring as shown in following diagrams.

The last letter G, if used, indicates it is a glass unit. If no letter is used here, it is usually a metal unit.

Wiring Diagrams. Note that both 4 prong UX and octal type bases are used.

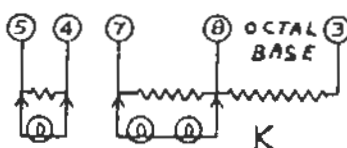
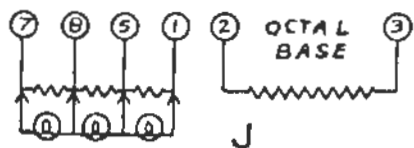
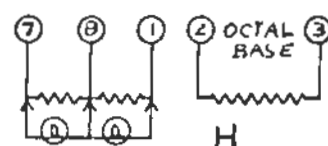
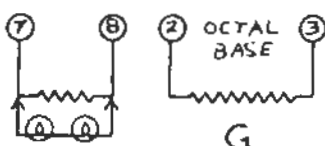
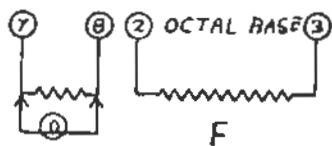
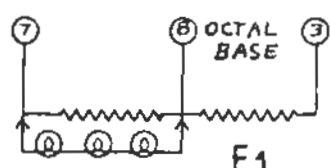
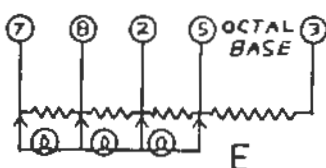
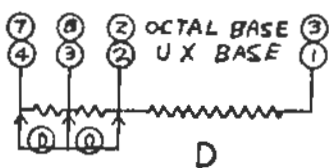
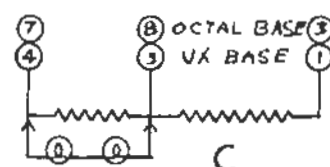
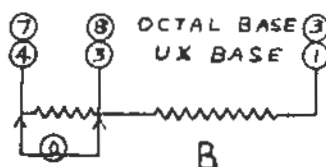
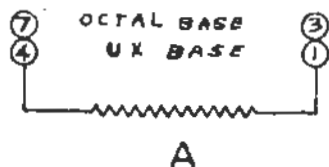

See Chart 2 for Non-Standard basing information.

Chart No. 2

Non-Standard Codes

A & B Series: 42A1 50A2 92B2 etc.

This group used 4 and 5 prong bases, 8 pin octal, and 9 pin miniature. The first number indicates the voltage drop of unit; A1 means no pilot lamps used, A2 indicates one lamp used, and B2 is for two pilot lamps.

J Series: K67BJ L36DJ M55CJ etc.

This is an octal base group that uses the standard numbering and wiring system but have a letter J following the designation. These have a jumper internally connected, usually across pins 3 and 4. This arrangement was to provide a space for another resistance in case the set had to be operated on a higher line voltage. Of course another ballast with this extra resistor built in would have to be used.

P Series: K55BP K55CP K55CPR etc.

In the P series of ballasts, the standard octal base numbering and wiring system is used with an additional resistor of about 50 ohms generally connected between pins 5 and 7. This was to limit the rectifier plate current in case of shorts.

R, L, & M Series: 165R4 140L8 165L44 185M8 etc.

This is a group using 4 prong bases. The first number indicates the overall resistance of the unit. The letter indicates the pilot lamp(s) used as in the RMA standard system (except R is used instead of K). The final number 4 indicates one pilot lamp, 8 is two pilot lamps, and 44 is two lamps with separate taps. See diagrams next page.

S Series: K49S1 L55S2 L80S3 etc.

This is an octal base group that uses Z wiring (covered at end of this chart), but also has an additional resistor of approximately 50 ohms connected between pins 3 and 7 to limit plate current of the rectifier in case of a short. The number after the S indicates the use of one, two, or three pilot lamps in series in the Z wiring B or C circuit. The K or L is still the standard pilot lamp designation.

Hyphenated Designations: K42B-K4 K49D-10

Whenever pilot lamps are to be operated at a value other than their rated voltage, a hyphen is inserted with a second set of digits to indicate the pilot lamp's operating voltage.

Cont'd next page.

Chart No. 2 Cont'd.

X Series: KX23B LX42D MX67A

The letter X between pilot lamp designation letter and the voltage drop numeral indicates that unit has a 4 prong base.

Y & Z Series: KY42B KZ49C

The letter Y or Z after the pilot lamp designating letter indicates that no standard pin wiring arrangement is used, although it is an octal base. The following diagrams show the system generally accepted.

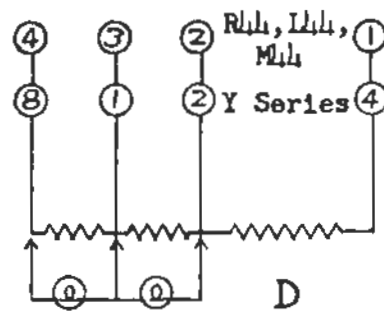
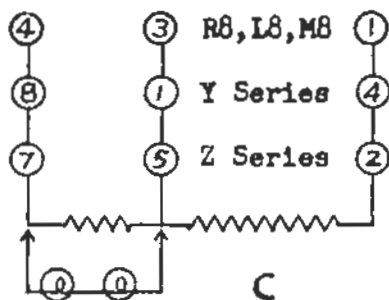
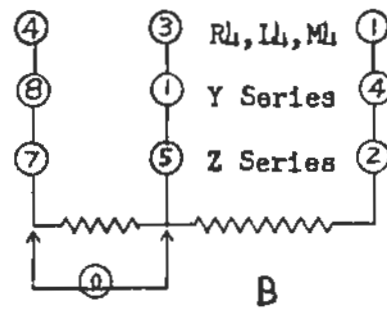
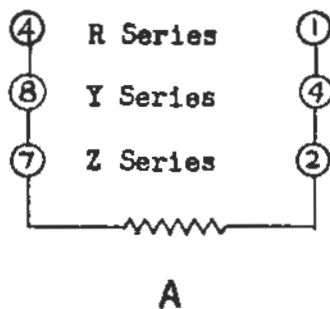

Chart No. 3

Universal Replacements for most Standard tube types.

Universal Tube No.	Replaces tubes beginning with	Numbers from	Ending in letter
10-23-A, 10-23-1, URB-001, 45-4001	BK, BL, K, L, M	10 to 23	A, B, C, D
10-23-E, 10-23-2, URB-002	BK, BL, K, L, M	10 to 23	E
10-23-F, 10-23-3, URB-003, 45-4001-2	BK, BL, K, L, M	10 to 23	F, G, H
23-55-A, 23-55-1, URB-004	BK, BL, K, L, M	23 to 55	A, B, C, D
23-55-E, 23-55-2, URB-005	BK, BL, K, L, M	23 to 55	E
23-55-F, 23-55-3, URB-006	BK, BL, K, L, M	23 to 55	F, G, H
60-92-A, 60-92-1, URB-007	BK, BL, K, L, M	60 to 92	A, B, C, D
60-92-E, 60-92-2, URB-008	BK, BL, K, L, M	60 to 92	E
60-92-F, 60-92-3, URB-009	BK, BL, K, L, M	60 to 92	F, G, H
92-105-A, 92-105-1	BK, BL, K, L, M	92 to 105	A, B, C, D

10-23-A, 10-23-1, URB-001, 45-4001	
10-23-E, 10-23-2, URB-002	
10-23-F, 10-23-3, URB-003, 45-4001-2	
23-55-A, 23-55-1, URB-004	
23-55-E, 23-55-2, URB-005	
23-55-F, 23-55-3, URB-006	
60-92-A, 60-92-1, URB-007	
60-92-E, 60-92-2, URB-008	
60-92-F, 60-92-3, URB-009	
92-105-A, 92-105-1	

All tubes are octal base type.

Chart No. 4

Universal Replacements for most Standard tube types.

Amperite Tube No.	Replaces tubes beginning with	Numbers from	Ending in letter
KL-25	BK, BL, BM, K, L, M	10 to 36	A, B, C, D
KL-45	"	36 to 67	"
KL-75	"	67 to 105	"
KL-25E	BK, EM, K, L, M	10 to 36	E
KL-50E	"	36 to 67	E
KL-75E	"	67 to 105	E
KL-25H	BK, K, L, M	10 to 36	F, G, H
KL-50H	"	36 to 67	"
KL-75H	"	67 to 105	"
KL-25J	BK, K, L, M	10 to 36	J
KL-45J	"	36 to 67	J
KL-75J	"	67 to 105	J
KL-50S1	K, L, M	40 to 100	S1
KL-50S2	"	40 to 100	S2
KL-50S3	"	40 to 100	S3

4P-45	4 prong base.	
50-AB	Octal base.	
KL-25	Octal base.	
KL-45	Octal base.	
KL-75	Octal base.	
KL-220	Octal base.	
KL-25E	Octal base.	
KL-50E	Octal base.	
KL-75E	Octal base.	
KL-25H	Octal base.	
KL-50H	Octal base.	
KL-75H	Octal base.	
KL-25J	Octal base.	
KL-50J	Octal base.	
KL-75J	Octal base.	
KL-50S1	Octal base.	
KL-50S2	Octal base.	
KL-50S3	Octal base.	

Chart No. 5

Majestic Ballast Tubes for Power Units
(Used in primary of power transformer)

<u>Tube Type</u>	<u>Color</u>	<u>Line Volt.</u>	<u>Freq. CPS</u>	<u>Pri. Volts of Trans.</u>	<u>Volt Drop of Tube</u>	<u>Power Unit Type</u>	<u>Rider's Refer.</u>
B	Black	115	25-30-40	60	55	7P3	1-2
B	Black	115	60	80	35	7P6	1-2
7BP3	Red	115	25	80	35	7BP3	1-7
7BP3	Red	115	30	80	35	7BP3	1-7
7BP3	Red	115	40	80	35	7BP3	1-7
7BP6	Black	115	60	80	35	7BP6	1-7
7BP6	Blue	230	60	160	70	7BP6	1-7
8P3	Orange	115	25	90	25	8P3	1-9
8P3	Orange	115	30	90	25	8P3	1-9
8P3	Orange	115	40	90	25	8P3	1-9
8P6	Green	115	60	90	25	8P6	1-9
8P6	Yellow	230	60	180	50	8P6	1-9
9P3	Red	115	30	80	35	9P3	1-24
9P6	Black	115	60	80	35	9P6	1-24

Note: All tubes are 2 contact type.

Chart No. 6

JFD Adjustable Ballasts

Three J.F.D. air-cooled adjustable ballasts, types A, B, and C, will serve as replacements for over two thousand type ballasts used in early radios. These ballasts (plug-in resistors) have a foil strip at the base shorting out all the pins. It is color coded between each pin, and by cutting these at the proper places, most ballast resistor combinations can be met.

The data and instructions provided by JFD for the most popular ballasts are printed here.

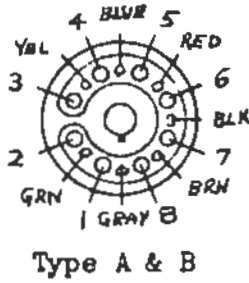

The actual cold resistance of either Brown or Gray section is 30 ohms but varies either higher or lower when in actual use. In operation with a pilot light in shunt the resistance is 20 ohms. When either one of these sections (Brown or Gray) is used alone with no other shunt cut, resistance value can be figured at 50 ohms. When either Brown or Gray is used without pilot light in shunt and with about 50% of the shunts or colors cut, the values of these sections will be about 60 ohms and will increase to 70 ohms if more are cut. (These are values when ballast is in actual use.)

Green strip has no resistance but can be used to isolate the pilot light section so that types such as J, H, and F ballasts can be replaced.

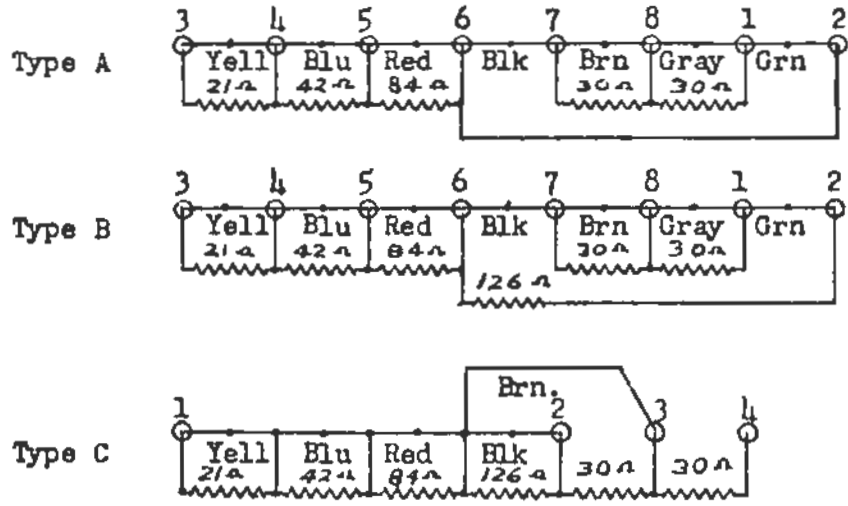
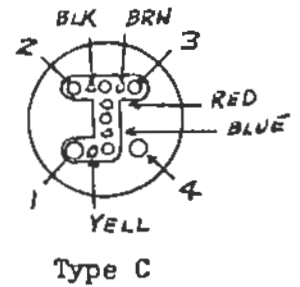

JFD Replacement Guide

Ballast No.	Use JFD Type	Break off pins	Out Strip at Colors
K, L, M, X23B	C	2	Blue, Yellow
K, L, M, X30B	C	2	Red
K, L, M, X36B	C	2	Red, Yellow
K, L, M, X42B	C	2	Red, Blue
K, L, M, X49B	C	2	Red, Blue, Yellow
K, L, M, X55B	C	2	Red, Brown, Yellow
K, L, M, X61B	C	2	Red, Blue, Brown
K, L, M, X67B	C	2	Black, Brown
K, L, M, X74B	C	2	Black, Brown, Yellow
K, L, M, X80B	C	2	Black, Brown, Blue
K, L, M, X86B	C	2	Black, Brown, Blue, Yellow
K, L, M, X92B	C	2	Black, Brown, Red
K, L, M, X98B	C	2	Black, Brown, Red, Yellow
K, L, M, X105B	C	2	Black, Brown, Red, Blue
K, L, M, X120C	C	2	Blue, Yellow
K, L, M, X130C	C	2	Red
K, L, M, X136C	C	2	Red, Yellow
K, L, M, X142C	C	2	Red, Blue
K, L, M, X149C	C	2	Red, Blue, Yellow
K, L, M, X155C	C	2	Red, Brown, Yellow
K, L, M, X161C	C	2	Red, Brown, Blue
K, L, M, X167C	C	2	Black, Brown
K, L, M, X174C	C	2	Black, Brown, Yellow
K, L, M, X180C	C	2	Black, Brown, Blue
K, L, M, X186C	C	2	Black, Brown, Blue, Yellow
K, L, M, X192C	C	2	Black, Brown, Red
K, L, M, X198C	C	2	Black, Brown, Red, Yellow
K, L, M, X105C	C	2	Black, Brown, Red, Blue
K, L, M, X123D	C	None	Brown, Blue
K, L, M, X130D	C	None	Brown, Blue, Yellow
K, L, M, X136D	C	None	Brown, Red
K, L, M, X142D	C	None	Brown, Red, Yellow
K, L, M, X149D	C	None	Brown, Red, Blue
K, L, M, X155D	C	None	Brown, Red, Blue, Yellow
K, L, M, X161D	C	None	Brown, Black, Blue
K, L, M, X167D	C	None	Brown, Black, Yellow, Blue
K, L, M, X174D	C	None	Brown, Black, Red
K, L, M, X180D	C	None	Brown, Black, Red
K, L, M, X186D	C	None	Brown, Black, Red, Yellow
K, L, M, X192D	C	None	Brown, Black, Red, Blue
K, L, M, X198D	C	None	Brown, Black, Red, Blue, Yellow
K, L, M, X105D	C	None	Brown, Black, Red, Blue, Yellow
K, L, M-6B	A	1-2-4	Black, Brown
K, L, M-11B	A	1-2-4	Black, Brown, Yellow
K, L, M-17B	A	1-2-4	Black, Brown, Blue

INSTRUCTIONS

The first letter before the number such as in K-49-B designates the pilot light. The numeral represents the voltage drop and the last letter indicates the R.M.A. circuit wiring. The letters K, L, M, designate the pilot light used and have no bearing on the ballast as they will take care of any pilot light.

Pins are grooved so that they may easily be broken with a pair of pliers. Foil strip may be easily cut but must be cut cleanly so that no electrical connection remains. When the voltage drop of ballast to be replaced is not listed, use the nearest one as in the case of K-48-B, cut as instructions for K-49-B.

K, L, M-23B	A	1-2-4	Black, Brown, Yellow, Blue
K, L, M-30B	A	1-2-4	Black, Brown, Red
K, L, M-36B	A	1-2-4	Black, Brown, Red, Yellow
K, L, M-42B	A	1-2-4	Black, Brown, Blue, Red
K, L, M-49B	B	1-2-4	Black, Brown, Yellow
K, L, M-55B	B	1-2-4	Black, Brown, Blue
K, L, M-61B	B	1-2-4	Black, Brown, Yellow, Blue
K, L, M-67B	B	1-2-4	Black, Brown, Red
K, L, M-74B	B	1-2-4	Black, Brown, Yellow, Red
K, L, M-80B	B	1-2-4	Black, Brown, Blue, Red
K, L, M-86B	B	1-2-4	Black, Brown, Yellow, Blue, Gray
K, L, M-92B	B	1-2-4	Black, Brown, Yellow, Blue, Red
K, L, M-98B	B	1-2-4	Black, Brown, Yellow, Red, Gray
K, L, M-105B	B	1-2-4	Black, Brown, Blue, Red, Gray
K, L, M-6C	A	1-2-4	Black, Brown
K, L, M-11C	A	1-2-4	Black, Brown, Yellow
K, L, M-17C	A	1-2-4	Black, Brown, Blue
K, L, M-23C	A	1-2-4	Black, Brown, Blue, Yellow
K, L, M-30C	A	1-2-4	Black, Brown, Red
K, L, M-36C	A	1-2-4	Black, Brown, Red, Yellow
K, L, M-42C	A	1-2-4	Black, Brown, Blue, Red
K, L, M-49C	B	1-2-4	Black, Brown, Yellow
K, L, M-55C	B	1-2-4	Black, Brown, Blue
K, L, M-61C	B	1-2-4	Black, Brown, Yellow, Blue
K, L, M-67C	B	1-2-4	Black, Brown, Red
K, L, M-74C	B	1-2-4	Black, Brown, Yellow, Red
K, L, M-80C	B	1-2-4	Black, Brown, Blue, Red
K, L, M-86C	B	1-2-4	Black, Brown, Yellow, Blue, Gray
K, L, M-92C	B	1-2-4	Black, Brown, Yellow, Blue, Red
K, L, M-98C	B	1-2-4	Black, Brown, Yellow, Red, Gray
K, L, M-105C	B	1-2-4	Black, Brown, Blue, Red, Gray
K, L, M-42F	A	1-4	Black, Green, Brown, Blue, Red
K, L, M-49F	B	1-4	Black, Green, Brown, Yellow
K, L, M-55F	B	1-4	Black, Green, Brown, Blue
K, L, M-61F	B	1-4	Black, Green, Brown, Yellow, Blue
K, L, M-67F	B	1-4	Black, Green, Brown, Red
K, L, M-74F	B	1-4	Black, Green, Brown, Yellow, Red
K, L, M-80F	B	1-4	Black, Green, Brown, Blue, Red
K, L, M-86F	B	1-4	Black, Green, Brown, Blue, Red
K, L, M-90F	B	1-4	Black, Green, Brown, Yellow, Blue, Red
K, L, M-98F	B	1-4	Black, Green, Brown, Yellow, Blue, Red
K, L, M-36H	A	4	Black, Brown, Gray, Green, Red
K, L, M-42H	A	4	Black, Brown, Gray, Green, Yellow, Red
K, L, M-49H	A	4	Black, Brown, Gray, Green, Blue, Red
K, L, M-55H	B	4	Black, Brown, Gray, Green, Yellow
K, L, M-61H	B	4	Black, Brown, Gray, Green, Blue
K, L, M-67H	B	4	Black, Brown, Gray, Green, Yellow, Blue
K, L, M-74H	B	4	Black, Brown, Gray, Green, Red
K, L, M-80H	B	4	Black, Brown, Gray, Green, Yellow, Red
K, L, M-86H	B	4	Black, Brown, Gray, Green, Red, Blue
K, L, M-90H	B	4	Black, Brown, Gray, Green, Yellow, Red, Blue
K, L, M-98H	B	4	Black, Brown, Gray, Green, Yellow, Red, Blue

CONT'D NEXT PAGE

JFD Replacement Guide cont'd.

X23A	C	2-3	Yellow	32OR	C	2-3	Black, Brown, Blue, Yellow
X30A	C	2-3	Blue	34OR	C	2-3	Black, Brown, Red
X36A	C	2-3	Blue, Yellow	80LL	C	2	Blue, Yellow
X42A	C	2-3	Red	80LB	C	2	Blue, Yellow
X49A	C	2-3	Red, Yellow	80RL	C	2	Blue, Yellow
X55A	C	2-3	Red, Blue	80RB	C	2	Blue, Yellow
X61A	C	2-3	Red, Brown	100LL	C	2	Red
X67A	C	2-3	Red, Brown, Yellow	100LB	C	2	Red
X74A	C	2-3	Black, Brown	100RL	C	2	Red
X80A	C	2-3	Black, Brown, Yellow	100RB	C	2	Red
X86A	C	2-3	Black, Brown, Blue	120RL	C	2	Red, Yellow
X92A	C	2-3	Black, Brown, Blue	120RB	C	2	Red, Yellow
X98A	C	2-3	Black, Brown, Blue, Yellow	140RL	C	2	Red, Blue
X105A	C	2-3	Black, Brown, Red	140RB	C	2	Red, Blue
				165LL	C	2	Red, Blue, Yellow
6A	A	1-2-4-8	Yellow	165LB	C	2	Red, Blue, Yellow
11A	A	1-2-4-8	Blue	165RL	C	2	Red, Blue, Yellow
17A	A	1-2-4-8	Brown	165RB	C	2	Red, Blue, Yellow
23A	A	1-2-4-8	Red	185LL	C	2	Red, Brown, Yellow
30A	A	1-2-4-8	Red, Yellow	185LB	C	2	Red, Brown, Yellow
36A	A	1-2-4-8	Blue, Red	185RL	C	2	Red, Brown, Yellow
42A	B	1-2-4-8	Blue, Red, Yellow	185RB	C	2	Red, Brown, Yellow
49A	B	1-2-4-8	Black, Blue	200LL	C	2	Red, Brown, Blue
55A	B	1-2-4-8	Black, Blue, Yellow	200LB	C	2	Red, Brown, Blue
61A	B	1-2-4-8	Black, Red	200RL	C	2	Red, Brown, Blue
67A	B	1-2-4-8	Black, Brown, Yellow	200RB	C	2	Red, Brown, Blue
74A	B	1-2-4-8	Black, Blue, Red	220LL	C	2	Black, Brown
80A	B	1-2-4-8	Black, Blue, Red, Yellow	220LB	C	2	Black, Brown
86A	B	1-2-4-8	Black, Brown, Red	220RL	C	2	Black, Brown
92A	B	1-2-4-8	Black, Brown, Red, Yellow	220RB	C	2	Black, Brown
98A	B	1-2-4-8	Black, Blue, Red, Gray	240LL	C	2	Black, Brown, Yellow
105A	B	1-2-4-8	Black, Brown, Red, Blue, Yellow	240LB	C	2	Black, Brown, Yellow
				240RL	C	2	Black, Brown, Yellow
				240RB	C	2	Black, Brown, Yellow
80R	C	2-3	Yellow	260RL	C	2	Black, Brown, Blue
100R	C	2-3	Blue	260RB	C	2	Black, Brown, Blue
120R	C	2-3	Blue, Yellow	280LL	C	2	Black, Brown, Blue, Yellow
140R	C	2-3	Red	280LB	C	2	Black, Brown, Blue, Yellow
165R	C	2-3	Red, Yellow	300LL	C	2	Black, Brown, Red
185R	C	2-3	Red, Blue	300RB	C	2	Black, Brown, Red
200R	C	2-3	Red, Brown	320LL	C	2	Black, Brown, Red, Yellow
220R	C	2-3	Red, Brown, Yellow	320RB	C	2	Black, Brown, Red, Yellow
240R	C	2-3	Black, Brown	340LL	C	2	Black, Brown, Red, Yellow
260R	C	2-3	Black, Brown, Yellow	340RB	C	2	Black, Brown, Red, Yellow
280R	C	2-3	Black, Brown, Blue				
300R	C	2-3	Black, Brown, Blue				

Cartridge Ballasts

Illustrations Courtesy Antique Radio Classified

In the very early days of radio, the filaments of the vacuum tubes were made of tungsten which required a fairly precise operating temperature range to insure maximum efficiency and long life. Therefore, it was necessary to maintain the current and voltage of each one within certain limits. Most of the tubes then used were rated at 5.0, 3.3, or 1.1 volts, with currents of 1.0, .50, and .06 amps. Since the standard power sources were 2 volt or 6 volt wet cell batteries and 1.5 volt dry cells, some means was needed to compensate for the excess voltage (and eventual drop of voltage) during use. Many manufacturers used a small rheostat in series with each tube filament which was adjusted to the correct operating current. As the battery voltage decreased, these rheostats had to be readjusted. This was not done to best advantage unless the set owner had proper meters to check the voltage.

About 1922 the Radiall Co. of New York developed a device variously called Automatic Filament Current Adjuster, Self Adjusting Rheostat, or Amperite. It was a cartridge type Ballast. This device, resembling a large fuse or grid leak, was about 3/8" in diameter and 2" long and was connected in the filament circuit of each tube in place of the usual manual rheostat.

This 'Amperite' contained a specially treated filament hermetically sealed in a small glass tube filled with an inert gas. The filament had the property of automatically changing resistance as the A battery voltage changed--so that a practically constant current was maintained in the tube filament. Thus the tubes were operated at maximum efficiency. In most cases one Amperite was used for each tube. About 1930, as the construction of tube filaments and cathodes improved, the Amperite evolved into a glass bulb Ballast tube with the same current controlling characteristics; but now one ballast tube could control all the radio set's tubes. Each ballast was constructed to handle a certain number of radio tubes. Also, about this same time, the Radiall Co. became the Amperite Co. and continued the manufacture of many types of Ballast tubes.

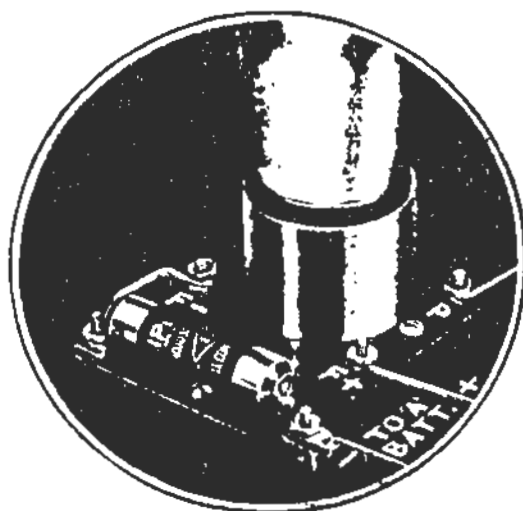

TUBE	FILAMENT CURRENT "AMPERES"	TYPE AMPERITE TO USE	"A" BATTERY SUPPLY "VOLTS"	TUBE
RADIOTRON UV-201-A	.25	AMPERITE No. 1 A	6	CUNNINGHAM C-401-A
RADIOTRON UX-201-A	.25	AMPERITE No. 1 A	6	CUNNINGHAM CX-401-A
RADIOTRON UV-199	.06	AMPERITE No. 4 V-199	4 or 4½	CUNNINGHAM C-299
RADIOTRON UV-198	.06	AMPERITE No. 6 V-198	6	CUNNINGHAM C-298
RADIOTRON UX-199	.06	AMPERITE No. 4 V-199	4 or 4½	CUNNINGHAM CX-299
RADIOTRON UX-198	.06	AMPERITE No. 6 V-198	6	CUNNINGHAM CX-298
RADIOTRON WG-11	.25	AMPERITE No. D-11	1.5	CUNNINGHAM C-11
RADIOTRON WG-12	.25	AMPERITE No. D-11	1.5	CUNNINGHAM C-12
RADIOTRON WE-12	.25	AMPERITE No. D-11	1.5	CUNNINGHAM CX-12
RADIOTRON UX-112 UX-171	0.5	AMPERITE No. 112	6	CUNNINGHAM CX-112 CX-171
RADIOTRON UX-120	.175	AMPERITE No. 120	4 or 4½	CUNNINGHAM CX-120
RADIOTRON UV-201	1.0	AMPERITE No. 1	6	WEST. ELEC. 218-A
DE FOREST DV-2	.25	AMPERITE No. 1 A	6	DE FOREST DV-6
DE FOREST DV-3	.06	AMPERITE No. 4 V-199	4 or 4½	DE FOREST DV-3
MAGRAYOR "A" TRUE BLUE	.25	AMPERITE No. 1 A	6	SUPERTRON 201-A
STEWART WARNER SR-501-A	.25	AMPERITE No. 1 A	6	300108 0-31

RCA BALLAST TUBE
CROSS REFERENCE

<u>Stock No.</u>	<u>Orig. No.</u>	<u>Latest No.</u>
MI-8115	135K1A	
MI-8159-1		M-91462-7
MI-8159-2		M-91462-8
14649	135-K1	BK-42-B
30284	95-K2	BK-36-C
30300		260-K1
30599		495-K1
31005		K-36-F
31019		K-61-F
31198		BK-55-B
31577	BK-36-B	K-83747-6
31585	BK-61-H	BK-61-B
32109		K-61-H
32247		K-85277-3
32544		BK-49-B
32849		K-85277-5
32850		K-85277-4
33793		B-86-A
33811		M-86892-1
33812		M-86892-2
33813		M-86892-3
33947		M-86892-4
34458		M-86892-7
34563	WW48	M-86892-6
34805		M-86892-8
35000		M-86892-9
35183		M-86892-10
35635		M-91462-2
35748		M-91462-1
37847		M-86892-11
37891		M-91462-3
37983		M-91462-5
38289		M-91462-6
38702		K-920117-1
39346		M-95178-10
39575		K-920146-1

Tube Base Diagrams



1



2

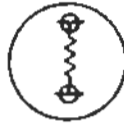

3



4



5



6



7

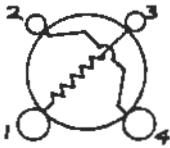

8

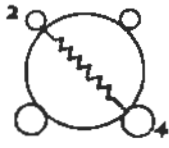

9

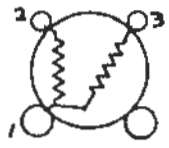

10



11

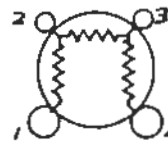

12

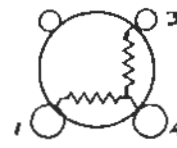

13

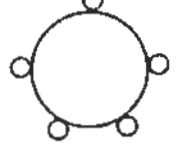

14



15

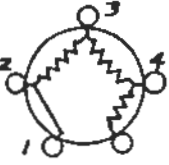

16

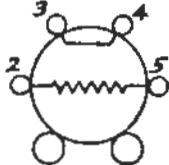

17

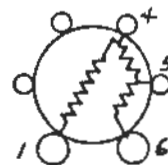

18

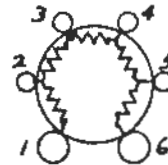

19

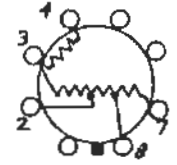

20



21

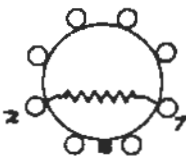

22



23

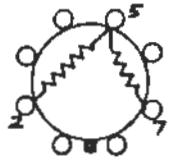

24

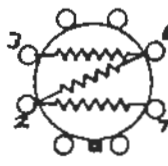

25

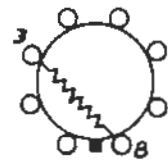

26

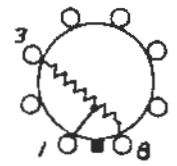

27

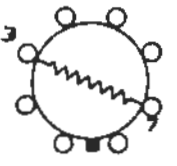

28

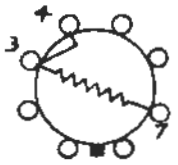

29



30

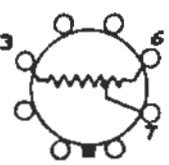

31



32



33



34



35



36



37

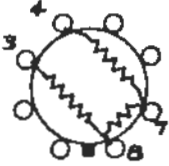

38

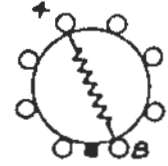

39



40



41



42



43



44



45



46



47



48



49

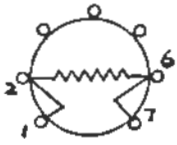

50

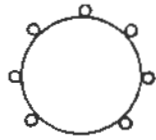

51

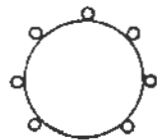

52



53



54

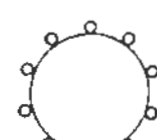

55

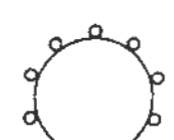

56



57



58

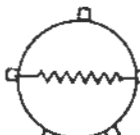

59



60



61



62



63

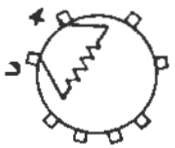

64

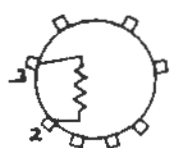

65

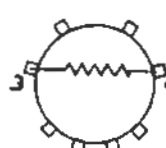

66

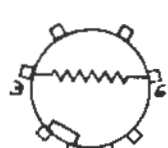

67

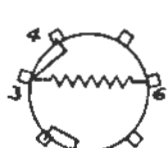

68

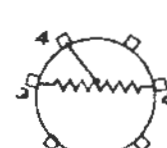

69



70

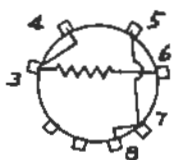

71



72



73

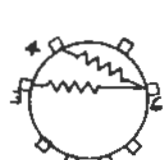

74

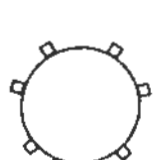

75

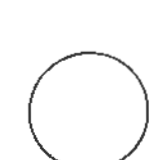

76

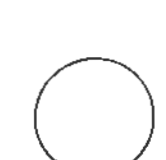

77

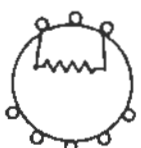

78

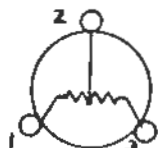

79

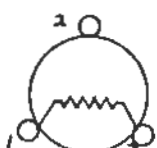

80

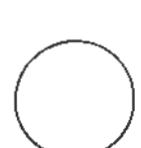

81

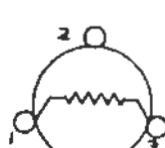

82



83

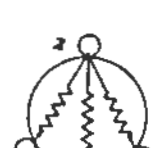

84

BALLAST TUBE HANDBOOK
SUPPLEMENT #1

Type	Use Manuf.	Volt.	MA.	Base	Notes	Rider's Refer.
D6TF4	USA	4.3-8.3	60			
D6TF9	"	12-30	60			
D6TK7	"					
D7TF7	"	8.0-12.0	80			
D8TF10	"	12-30	80			
D8TF20	"	20-40	80			
TJ 311 M	"					
TJ 601 K	"					
TJ 791 K	"					
1-3	USA	5.0	1100			
1-15	"	12-46	120			
1H-20	"	18-60	150			
1H-46	"	35-87	170			
1HM4	"					
1TF2	"	2.6-4.4	100			
2-14	USA	14-20	200	22		
2TK7	"					
3-38	USA	60	500			
3A10A	"	15-30	300			
3A20B	"	20-40	350			
3H-7	"					
3H-20B	"	16-40	400			
3HTF7	"	7.0-18.5	350	53 #		
3HTF11	"	11.3-16.4	400	53 #		
3TF4A	"	5.6-8.4	270-300	53		
3TF7A	"	7.0-14.0	280-310	53		
3TF11	"	8-17	280-320	53		
4A10S	USA	12-30	450			
4A11	"	16-24	400			
4H-12A	"	25	500			
4H-25	"	25-63	450			
4HTF7	"	7.0-15.0	500			
4TF7	"	5.0-12.7	450			
5-4B	USA					
5-12	"	24	550			
5A12	"	26-31	500			
5A20	"	20-60	550			
5HA20	"	20-40	600			
5HTF4	"	4.5-7.8	600			
6-4B	USA	10	650			
6-36	"					
6A10A	"	12-30	650			
7-7A	USA					
7A20	"	15-37	750			
7H-7	"	7.3-10.0	750			
7H-7B	"	7.8-11.6	800			
7H-30	"	32-78	900			

Type	Use Manuf.	Volt.	MA.	Base	Notes	Rider's Refer.
8-4B	USA	4.6-6.7	900			
8-4C	"					
8-4D	"	4.7-9.0	850			
8A10A	"	13.5-29.5	900			
8TF3	"	3.3-4.4	850			
9-2	USA	3.5-4.95	1000			
9-5	"					
9-6	"	11.6-16.2	950			
10-7	USA	15	1100			
11-3 (Amperite)	USA	3.5-6.5	1250			
12-1H	USA	3.0	1500			
12-3H	"	6.5	1500			
14A20	USA	15-40	1500			
15-2	USA	1.7-3.4	1750			
15-4	"	4.7-7.6	1500			
17A20	USA	20-40	2000			
20-1H	USA	1.3-3.8	2250			
20R4	"	4.8-8.3	2000			
22-2	"	1.3-4.14	2500			
22-12	"	12.5-17.5	2500			
27-7	"	3.5-11.0	2750			
30-7	USA	5.0-9.1	3500			
30-11	"	11-18	3250			
30R4	"	4.55-6.85	3000			
30TF1	"	1.2-2.4	3250			
33-11B	"	6.5-19.5	4000			
34-2	"	3.4- 5.1	3500			
35-4 (Amperite)	"	4.5-7.5	3750			
36-11	"	6.5-19.5	4750			
40-3	USA	3.0-5.0	4000			
40-4	"	4.8-6.7	4250			
41-2	"	3.1-4.9	4250			
42-2H	"	3.0-3.5	4500			
43-3	"	3.7-7.7	4500			
46-2	"	2.2-4.5	5000			
50-1H	USA	1.8-2.4	5250			
50-2	"	1.7-2.8	5500			
50-4	"	4.0-8.0	5000			
55-1H	"	2.7-3.4	6000			
60-1	USA	1.5-3.5	6750			
124A	USA					

•

•

•

•

•

•